

This Owner's Manual is provided and hosted by [Appliance Factory Parts](#).



# HONEYWELL 11525 Owner's Manual

[Shop genuine replacement parts for HONEYWELL  
11525](#)



[Find Your HONEYWELL Air Cleaner Parts - Select From 215 Models](#)

----- Manual continues below -----

**Honeywell**

**enviraire®**

# Portable HEPA Air Cleaners

READ AND SAVE THESE INSTRUCTIONS

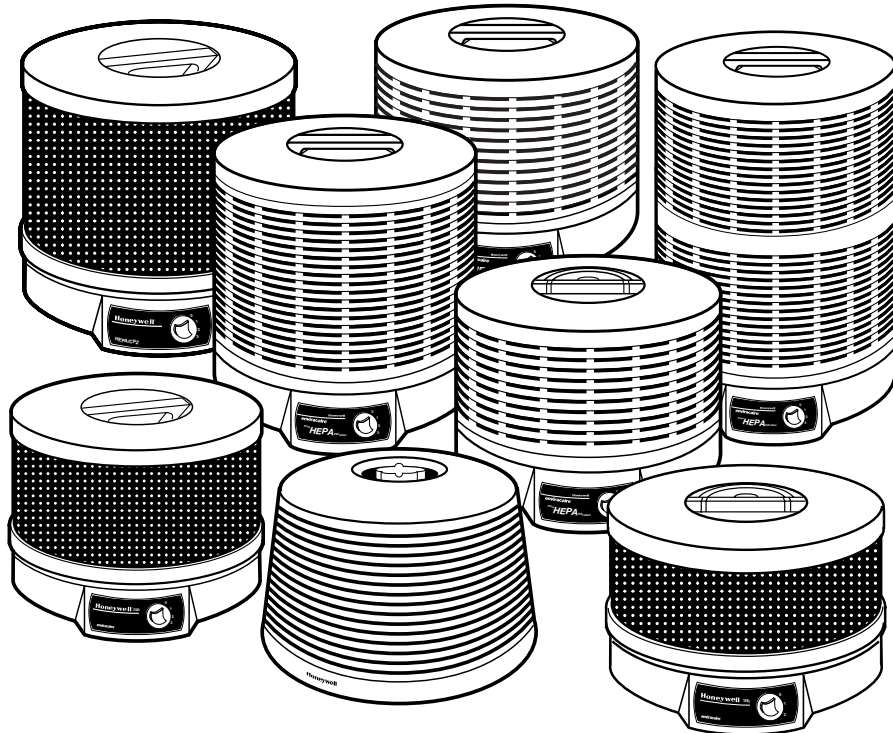

## Owner's Guide

For Model Series

10500 • 11500 • 12500 • 13350 • 13500

and 14500 Air Cleaners

**The Science of Clean Air™**

## Important Safety Instructions ...

PLEASE READ ALL INSTRUCTIONS BEFORE USING THIS PRODUCT. Save these instructions for easy reference.

When using electrical appliances, basic precautions should always be followed to reduce breakage, risk of fire, electric shock and injury to persons including the following:

1. Read all instructions before operating the air cleaner.
2. Place air cleaner where it is not easily knocked over by persons in the household.
3. Always unplug when not in use.
4. Do not use any product with a damaged cord or plug or if product malfunctions, is dropped or damaged in any manner. Keep the cord away from heated surfaces.
5. Do not use air cleaner outdoors.
6. Never use air cleaner unless it is fully assembled.
7. Do not run power cord under carpets, and do not cover with throw rugs. Arrange cord such that it will not be tripped over.
8. Do not use air cleaner where combustible gases or vapors are present.
9. Do not expose the air cleaner to rain, or use near water, in a bathroom, laundry area or other damp location.
10. To disconnect the air cleaner, first turn speed control to OFF position and remove plug from the outlet.
11. The air cleaner must be used in its upright position.
12. Do not allow foreign objects to enter ventilation or exhaust opening as this may cause electric shock or damage to the air cleaner. Do not block air outlets or intakes.
13. Locate air cleaner near power outlet and avoid using an extension cord.
14. The air cleaner has a polarized plug (one blade is wider than the other). To reduce risk of shock, this plug is intended to fit in a polarized outlet only one way. If the plug does not fit fully in the outlet, reverse the plug. If it still does not fit, contact a qualified electrician. **DO NOT** attempt to defeat this safety feature.
15. A loose fit between the plug and the AC outlet (receptacle) may cause overheating and a distortion of the plug. Contact a qualified electrician to replace loose or worn receptacles.
16. Do not sit, stand or place heavy objects on the air cleaner.
17. Disconnect power supply before servicing.
18. **WARNING: To reduce risk of fire or electric shock, do not use this product with any solid-state speed control device.**

## Congratulations...

You now own a quality portable HEPA air cleaner that has been engineered and crafted for your satisfaction.

**Honeywell** air cleaners incorporate a true HEPA filter. HEPA is an acronym for *High Efficiency Particulate Air*.

Our Consumer Relations representatives will be pleased to help with any questions or concerns you may have about your **Honeywell** air cleaner. Please call our Consumer Relations Dept. at (800) 332-1110 for assistance.

## For Best Performance ...



We recommend that you operate your **Honeywell** air cleaner 24 hours a day because indoor air can be quickly contaminated by activity in a room, infiltration of outside air, and generation by sources of contamination. While all the air in a room will not be processed by the air cleaner, the more air circulated through the filter, the more filtered air returned to the room. Portable air cleaners will be much more effective in rooms where all doors and windows are closed.

The **Honeywell** HEPA air cleaner is ready to begin cleaning air as soon as it is removed from the carton and plugged in. Because it circulates air in a 360 degree pattern around the air cleaner, it can be placed on the floor in almost any location. However, for best performance the air outlet slot should not be blocked for at least 1 meter (three feet) in all directions.

Due to the large volume of air drawn towards the air cleaner, surrounding areas should be cleaned and/or vacuumed frequently to prevent buildup. This may help keep your home cleaner and may extend the life of your pre-filter. If the unit is placed on light colored carpeting, a small mat or rug should be used to ease cleaning and prevent any permanent staining. This is particularly important in homes with heavier contamination from smoking or fireplaces.

## 10500 Series ...

The **Honeywell** 10500 Series air cleaner is a 2 speed air cleaner. As a safety feature, when the filter cage cover is removed, the switch will automatically be placed in the off position. The unit cannot be turned on with the filter cage cover removed.

To operate the unit, turn the round switch to the high setting and then adjust to the desired speed. International symbols indicate off , low  and high , as shown in the diagram.

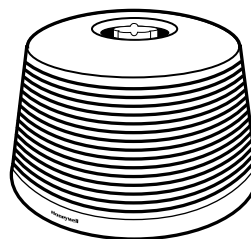

### To Unlock:

Rotate the filter cage cover counterclockwise until it stops and lift cover.

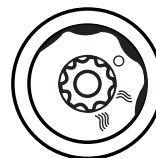

### To Lock:

Place the filter cage cover and rotate until it falls into place. Rotate clockwise until it stops.

### 11500 Series ...

The **Honeywell** 11500 Series air cleaner is a 2 speed air cleaner operated by moving the speed control knob on the base from the Off ("0") position to the high ("2") position. Allow the unit to operate for a few seconds at high speed, then leave the control knob in the high position for faster, powerful room cleaning, or move the knob to the lower setting for quieter operation.

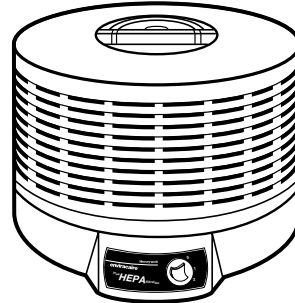

### 12500 Series ...

The **Honeywell** 12500 Series air cleaner is a 3 speed air cleaner operated by moving the speed control knob in the base from the Off ("0") position to the high ("3") position. Allow the unit to operate for a few seconds at high speed, then leave the control knob in the high position for faster, powerful room cleaning, or move the knob to a lower setting for quieter operation.

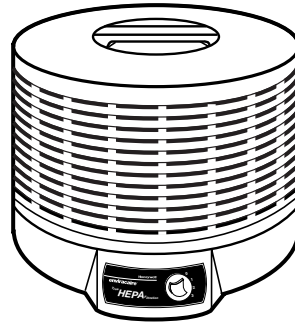

### 13350, 13500 and 14500 Series ...

The **Honeywell** 13350, 13500 and 14500 Series air cleaner is a 3 speed air cleaner operated by moving the speed control knob on the base from the Off ("0") position to the high (3") position. Allow the unit to operate for a few seconds at high speed, then leave the control knob in the high position for faster, powerful room cleaning or move the knob to a lower setting for quieter operation.

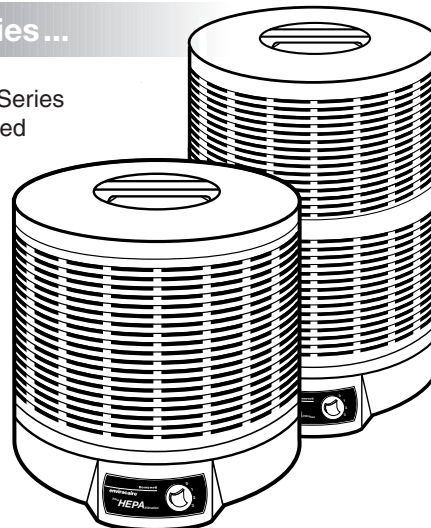

## Construction ...

Your **Honeywell** air cleaner has four basic components: the filter cage cover, the HEPA filter, the activated carbon pre-filter, and the base assembly (with controls and motor).

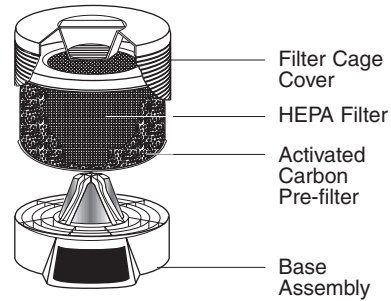

## Replacement Filters...

Select the proper replacement filter for your **Honeywell** HEPA air cleaner from the chart below:

<u>Model No.</u>	<u>HEPA Filter Part Number</u>	<u>Carbon Pre-filter Part Number</u>
10500 Series	20500	32002/38002
11500 Series	21500	32002/38002
12500 Series	22500	33002/38002
13350 and 13500 Series	24000	34002/38002
14500 Series	25000	38002

Replacement filters may be purchased from the retail store or ordered from the dealer where you purchased the product. If you cannot locate one in your area, please call our Consumer Relations Dept. at (800) 332-1110 and we will direct you to a stocking dealer.

## Filter Replacement...

With proper maintenance, your **Honeywell** air cleaner is designed to provide years of high efficiency air cleaning. Your Honeywell air cleaner contains two filters: one activated carbon pre-filter and one primary HEPA filter.

The activated carbon pre-filter captures large airborne particles, and helps remove odors. The pre-filter should be replaced every 3 months. You may need to replace the pre-filter more often if the unit is used in a smoking environment or if unpleasant odors persist.

The primary HEPA filter should remain effective for 1 to 3 years, depending upon the environment in which the air cleaner is operating. Honeywell recommends changing the HEPA filter based upon operation conditions—every 3 years for light usage, 2 years for normal usage and 1 year for heavy usage.

Our recommendations regarding filter replacement intervals are intended as guidelines only. Life expectancy of any filter media is dependent on the concentration of the contaminants to which the system is exposed. If there are sources of large amounts of contaminant generation (such as woodworking or heavy smoking) the useful life of the filter media in your air cleaner may be reduced.

Whenever the combined air resistance of the activated carbon pre-filter and primary HEPA filter becomes excessive due to the amount of contaminants they have captured, the air cleaner will begin to audibly pulsate. Instead of a steady stream of air, rapid "puffs" of air may be felt at the outlet slot. When this occurs, one of two conditions exists:

1. The activated carbon pre-filter is clogged and must be replaced.
2. If the unit continues to pulsate after a new pre-filter is installed, the useful life of the HEPA filter has been reached and it must be replaced.

## Important...

**Replace the activated carbon pre-filter at least every 3 months. The activated carbon pre-filter is the element of your air cleaner that helps reduce normal household odors, captures lint and other large particles and protects and helps extend the life of the HEPA filter.**

If there are heavy concentrations of odors, smoke, or large particles in the home, you may need to change the activated carbon pre-filter more often.

We **DO NOT** recommend operating the air cleaner without the activated carbon pre-filter. The HEPA filter may become contaminated and begin to emit any odors captured.

**CAUTION: Do not attempt to wash either the activated carbon pre-filter or the HEPA filter. They are not washable and washing will damage the filters.**

## How to Change the Filters...

### CAUTION: DISCONNECT FROM POWER SUPPLY BEFORE SERVICING

The only two parts requiring any service are the activated carbon pre-filter and the HEPA filter. No tools are needed. To change either filter, disassemble the unit as shown.

1. Loosen the carrying handle by turning it counterclockwise and lift filter cage cover from unit.

For Model Series 10500: With the unit on a carpeted floor, twist the air cleaner filter cage cover counterclockwise until it stops (about 90°), and lift the cover from the base.

2. Lift HEPA filter and activated carbon pre-filter from the base.
3. Remove the fasteners from the activated carbon pre-filter and remove it from the HEPA filter cartridge.
4. Replace filter(s) as needed, and discard used filters.
5. Wrap the activated carbon pre-filter around the HEPA filter cartridge and secure it with the fasteners provided.

Reassemble your **Honeywell** air cleaner as described below:

1. Place the assembled HEPA filter and the activated carbon pre-filter on the base.
2. Replace the filter cage cover.
3. Reattach the carrying handle and turn it clockwise until securely tightened.

For Model Series 10500: Position the filter cage cover on the unit. Press down on filter cage cover and rotate clockwise until it snaps securely into place. Place the power control switch in the OFF position.

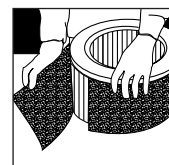
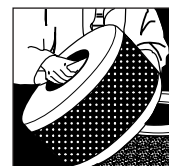
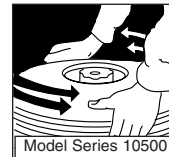
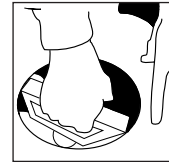

## If the Air Cleaner Does Not Operate...

- Check to make sure that the power cord is correctly connected to the outlet.
- Test that the outlet is functioning properly using another appliance or lamp.
- Check the fuse or circuit breaker. The outlet may be overloaded if other appliances are also in use. Determine and correct the cause of the overload.
- The thermal overload protection device on the air cleaner's motor may have engaged.
- If none of the above procedures restore operation, return your unit to the store or if the store's return policy does not allow, return the complete unit per the instructions in the warranty section of this owner's guide. Do not attempt to repair the unit yourself.

## Storage...

If you store your **Honeywell** HEPA air cleaner for more than 30 days, we recommend:

- Remove both the primary HEPA filter and the activated carbon pre-filter from the unit.
- Discard the pre-filter.
- Wrap the HEPA filter in an air-tight plastic bag or plastic wrap. Be sure that the filter is totally sealed.
- To restore the air cleaner to service, unwrap the HEPA filter, install a new activated carbon pre-filter, and replace both filters in the air cleaner. (See "How to change the Filters..." section for proper installation.)



## Limited Warranty...

### Honeywell HEPA Air Cleaner

**Model No. 10500, 11500, 12500,  
13350, 13500 and 14500 Series**

This product has been engineered and crafted with great care for your satisfaction. **Be sure to fill out and return the enclosed card within 7 days of purchase.**

**A.** This limited warranty applies to repair or replacement of product found to be defective in material or workmanship within 5 years of the date of purchase. This warranty does not apply to damage resulting from commercial, abusive, unreasonable use or supplemental damage. Defects that are the result of normal wear and tear will not be considered manufacturing defects under this warranty. HONEYWELL IS NOT LIABLE FOR INCIDENTAL OR CONSEQUENTIAL DAMAGES OF ANY NATURE. ANY IMPLIED WARRANTY, INCLUDING MERCHANTABILITY OR FITNESS FOR A PARTICULAR PURPOSE, ON THIS PRODUCT IS LIMITED IN DURATION TO THE DURATION OF THIS WARRANTY. Some jurisdictions do not allow the exclusion or limitation of incidental or consequential damages or limitations on how long an implied warranty lasts, so the above limitations or exclusions may not apply to you. This warranty gives you specific legal rights, and you also may have other rights which vary from jurisdiction to jurisdiction. This warranty applies only to the original Purchaser of this product.

**B.** At its option, Honeywell will repair or replace this product if it is found to be defective in material or workmanship within the warranty period. Defective product should be returned to the place of purchase in accordance with store policy or to Honeywell.

**C.** This warranty does not cover damage resulting from unauthorized attempts to repair or from any use not in accordance with this manual.

**D.** This warranty **DOES NOT** cover the pre-filter or the HEPA filter except for material or workmanship defects.

**E. Return defective product** to the following address with a brief description of the problem. Include proof-of-purchase and a U.S. \$10.00/Can \$13.00 check or money order for handling, return packing and shipping charges. Please include your name, address and daytime phone number. You must prepay shipping charges. Mark carton "**Attention Repair Department**"

**Ship to:**

Honeywell Inc.  
4755 Southpoint Drive  
Southpoint Distribution Center  
Memphis, TN 38118  
U.S.A.

Honeywell Consumer Products Canada  
510 Bronte St. South  
Milton, Ontario Canada L9T 2X6

If you experience a problem with your air cleaner, please see owner's guide for instructions. Please do not attempt to repair the air cleaner yourself. Doing so may void the warranty and could cause damage or personal injury. If the problem still persists, please call:

Honeywell Inc.  
Consumer Relations Dept.  
Toll Free 1-800-332-1110.

**Mail Questions or Comments to:**

Honeywell Inc.  
Consumer Relations Dept.  
250 Turnpike Road  
Southborough, MA 01772  
U.S.A.