

This Owner's Manual is provided and hosted by Appliance Factory Parts.

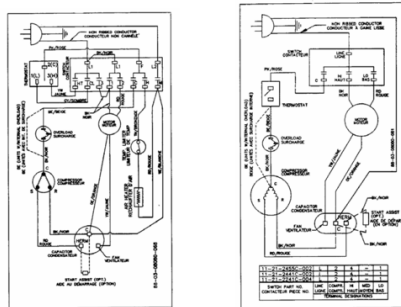

COMFORT-AIRE B-71B-C Owner's Manual

[Shop genuine replacement parts for COMFORT-AIRE B-71B-C](#)



Appliance Factory Parts
© <http://www.appliancefactoryparts.com>

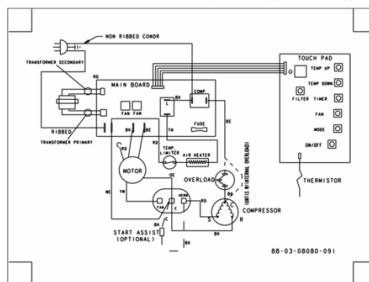

[Find Your COMFORT-AIRE Air Conditioner Parts - Select From 599 Models](#)

----- Manual continues below -----

**PARTS LIST
FOR**



AIR CONDITIONERS

MODEL NOS.

B-71B

B-101B

B-101C

B-103B

B-103C

BE-103C

B-123B

B-123C

BE-123B

**FOR CUSTOMER SATISFACTION, ALWAYS
USE FACTORY SPECIFIED PARTS**

HEAT CONTROLLER, INC.
1900 Wellworth Ave., Jackson, Michigan 49203
Ph. 517-787-2100

MODEL SPECIFICATIONS

MODEL	REV	BTUH	VOLTS	AMPS COOL	AMPS HEAT	WATTS COOL	WATTS HEAT	E.R. COOL	WIRING DIAGRAM	OZ. OF R22
COMFORT-AIRE										
B-71B	D	7000	115	7.5	N/A	780	N/A	9	WD81	13.75
B-71B	C	7000	115	7.5	N/A	780	N/A	9	WD81	13.5
B-101B	D	10000	115	10	N/A	1180	N/A	8.5	WD81	17
B-101C	A	10000	115	10	N/A	1110	N/A	9	WD81	21.5
B-103B	B	10000	230	6.2	N/A	1150	N/A	8.7	WD81	19.5
B-103B	C	10000	230	6.2	N/A	1150	N/A	8.7	WD81	21.5
B-103B	D	10000	230	6.2	N/A	1150	N/A	8.7	WD81	21.5
BE-103C	A	10000	230	6.2	14	1110	3200	9	WD68	21.5
BE-103C	B	10000	230	6.2	N/A	1110	3200	9	WD68	19.5
B-123B	D	12000	230	6.5	N/A	1380	N/A	8.7	WD81	22.5
B-123C	A	12000	230	6.5	N/A	1335	N/A	9	WD81	22.5
BE-123B	C	11500	230	6.5	14	1320	3200	8.7	WD68	22.5
BE-123C	A	11500	230	6.5	14	1280	3200	9	WD68	22.5

NOTE: REPLACEMENT PARTS FOR MODELS ARE THE SAME AS LISTED IN THE MAIN BODY OF THE PARTS LIST EXCEPT AS SHOWN ON F-RWM3-8-02 THRU F-RWM3-10-02

SPECIFICATONS: SIZE: 14 1/2" H X 25" W X 20 1/2" D

WIRING DIAGRAMS

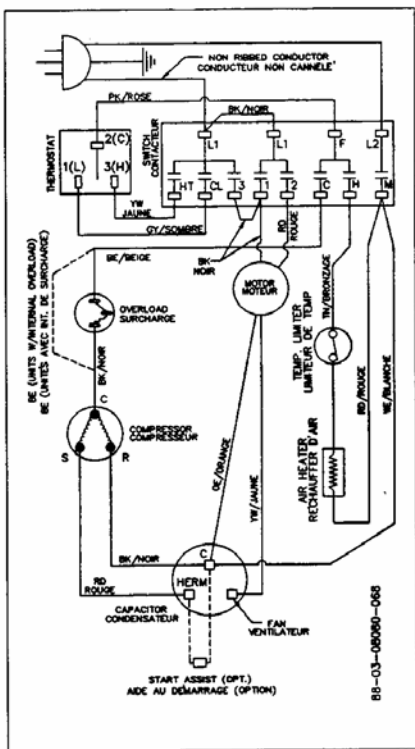

WD68

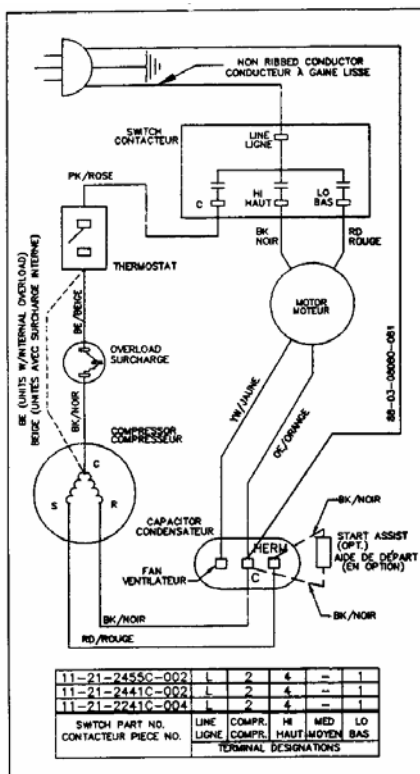

WD81

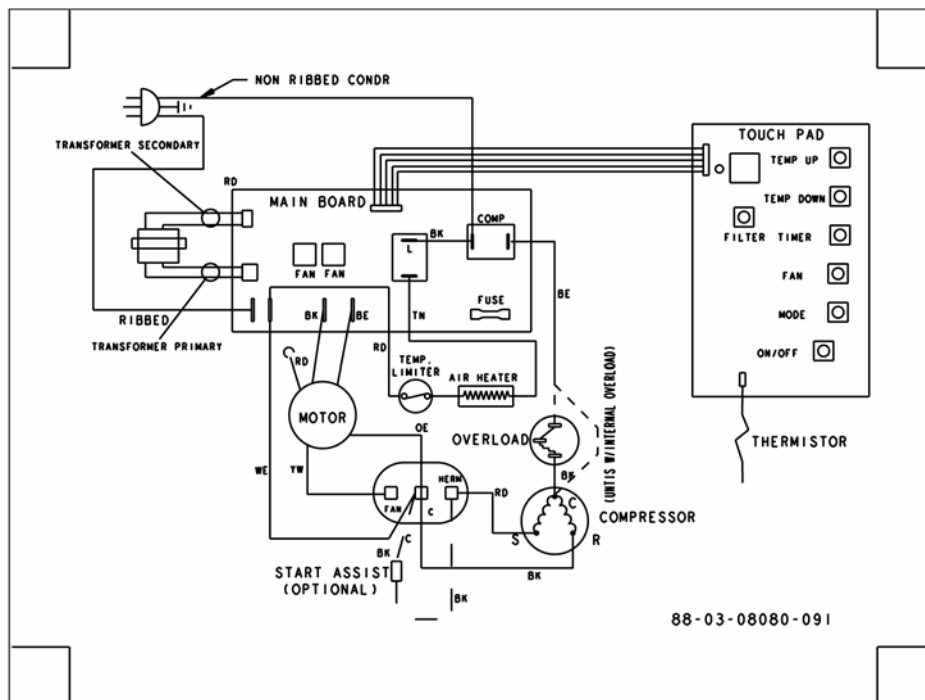

WD91

CABINET AND PACKAGING DETAIL

ITEM	DESCRIPTION	PART NO.	B-71B	B-71B	B-101B	B-101C	B-103B	B-103B	B-103B	BE-103C	BE-103C	BE-123B	BE-123C	B-123B	B-123C
			D	C	D	A	B	C	D	A	B	D	A	C	A
1	DEC FRONT ASM-C AIRE	113302190017	1	1	1	1	1	1	1	1	1
1	DEC FRONT ASM-C AIRE	113302190018	1	.	1	1	.	.
2	KNOB ASM-CAMEO WHITE	111410560001	2	2	2	2	2	2	2	2	2	2	2	2	2
3	FRAME-TRIM VERTICAL	113302380001	2	2	2	2	2	2	2	2	2	2	2	2	2
4	FRAME-TRIM HORIZONTAL	113302390001	2	2	2	2	2	2	2	2	2	2	2	2	2
5	CABINET ASM-INTL WHITE	113300220037	1	1	1	1
5	CABINET ASM-INTL WHITE	113300220032	1
5	CABINETASM, INTL WHITE	113300220036	1	1	1	1	1	.	1	1	1
6	FILTER-CAMEO WHITE	113302230001	1	1	1	1	1	1	1	1	1	1	1	1	1
7	SCREEN-WIRE GUARD,WM	113302340001	1	1	1	1	1	1	1	1	1	1	1	1	1
8	BAFFLE-WM, CONDENSER	113302520001	1	1	1	1	1	1	1	1	1	1	1	1	1
NI	INST BOOKLET-W/M COMFORT AIRE	23112221N002	1	1	1	1	1	1	1	1	1	1	1	1	1
PACKAGING PARTS															
NI	CARTON-COMFORT AIRE	131106760021	1	1	1	1	1	1	1	1	1	1	1	1	1
NI	CLAM SHELL-LH,WALL MOD	131106640006	1	1	1	1	1	1	1	1	1	1	1	1	1
NI	CLAM SHELL-RH,WALL MOD	131106640005	1	1	1	1	1	1	1	1	1	1	1	1	1
NI	EDGE PROTECTOR-27.031X	131104920009	1	1	1	1	1	1	1	1	1	1	1	1	1

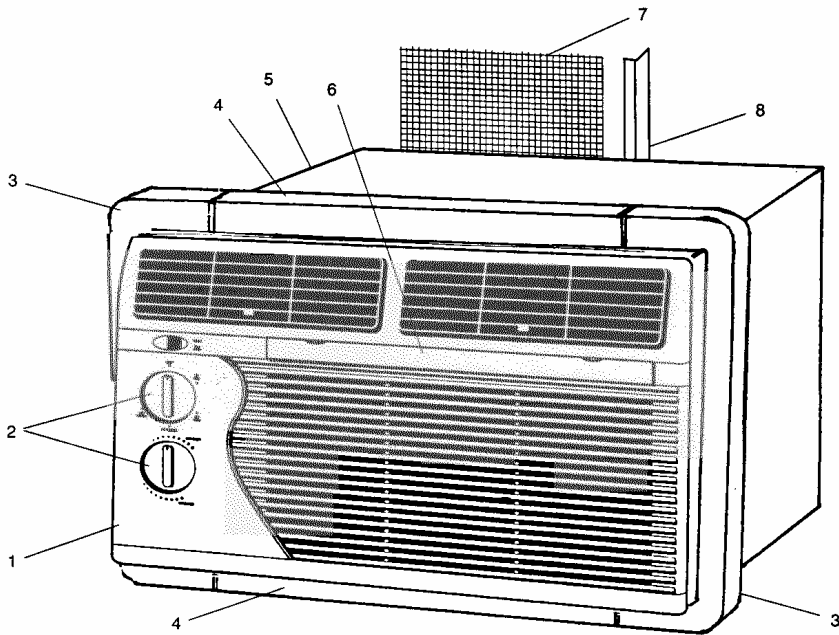

ELECTRICAL PARTS REFERENCE

ITEM	DESCRIPTION	PART NO.	B-71B	B-71B	B-101B	B-101C	B-103B	B-103B	B-103B	BE-103C	BE-103C	BE-123B	BE-123C	B-123B	B-123C
			D	C	D	A	B	C	D	A	B	D	A	C	A
MECHANICAL															
1	PANEL-WM, CONTROL	113302270001	1	1	1	1	1	1	1	1	1	1	1	1	1
2	POWER CORD, W/LABEL, 14/3, HTCL	112124270021	1	1	1	1	.	.
2	POWER CORD W-LABEL 16/3, 115V	112124270128	1	1	1	1
2	POWER CORD W-LABEL 18/3, 230V, CL	112124270035	1	1	1	1	1
3	THERMOSTAT, COOL	112123420004	1	1	1	1	1	1	1	1	1
3	THERMOSTAT, HEAT/COOL	112180000004	1	1	1	1	.	.
NI	CLIP-BULB,THERMOSTAT, COOL	112124250002	1	1	1	1	1	1	1	1	1
NI	CLIP, 1/4 BULB TO COIL HEAT/CL	112119550001	1	1	2	2	.	.
4	SWITCH-ROTARY, HEAT	112190000008	1	1	1	1	.	.
4	SWITCH-ROTARY,5 POSITION	112190000005	1	1	1	1	1	1	1	1	1
5	STRAP-CAPACITOR-RD-.625	112401310001	1	1	1	1	1	1	1	1	1	1	1	1	1
6	CAPACITOR 40/4-370	160500710147	.	.	1	1
6	CAPACITOR-25/4/370	160500710102	.	1	.	.	1	1	1	1	1	1	1	1	1
6	CAPACITOR-35/4/370	160500710141	1
7	START ASSIST-115/230	160603480001	1	1	1	1	1	1	1	1	1	1	1	1	1
NI	CLAMP STRAIN RELIEF	111400660002	1	1	1	1	1	1	1	1	1	1	1	1	1

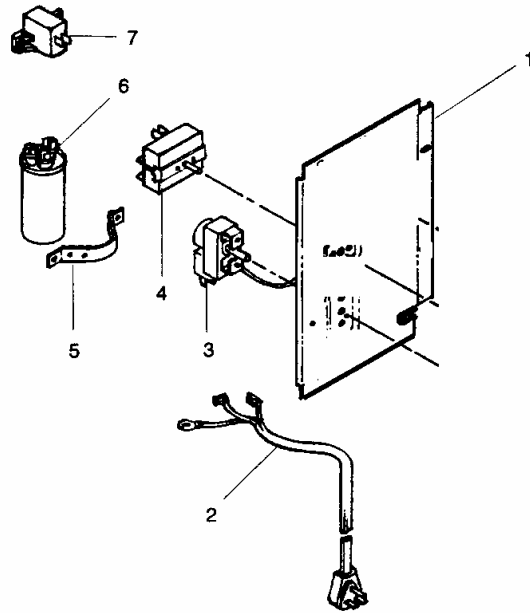

CHASSIS REFERENCE LIST

ITEM	DESCRIPTION	PART NO.	B-71B	B-71B	B-101B	B-101C	B-103B	B-103B	B-103B	BE-103C	BE-103C	BE-123B	BE-123C	B-123B	B-123C
			D	C	D	A	B	C	D	A	B	D	A	C	A
1	FAN-12-1/2 X 2" PIT 7 BLD	113302030001	1	1	1	1
1	FAN	F123161	1	1	1	1	1
1	FAN	F12161	1	1	1	1
2	SHROUD-CONDENSER, WM 2000	113302000002	1	1	1	1	1	1	1	1	1	1	1	1	1
3	BRACKET TIE WALL MODULE	112801790002	1	1	1	1	1	1	1	1	1	1	1	1	1
4	MOTOR-FAN, 115 VOLT	113390000008	1	1	1	1
4	MOTOR-FAN, 230 VOLT	113390000009	1	1	1	1
4	MOTOR-FAN, 230 VOLT	113390000010	1	1	1	1	1
5	PLATE-MOTOR MOUNTING	112124630001	1	.	.	.	1	1	1	1
6	BULKHEAD-W/M	113302360002	1	1	1	1	1	.	1	1	1	1	1	1	1
7	HOUSING-BLOWER	113300980004	1	1	1	1	1	1	1	1	1	1	1	1	1
9	WHEEL-BLOWER, 7.96 x 3.5	113302010001	1	1	1	1	1	1	1	1	1	1	1	1	1
10	VENTURI-EVAP, COOL	113300610007	1	1	1	1	1	1	1	1	1
10	VENTURI-EVAP, HEAT/COOL	113300610008	1	1	1	1	.	.
11	COVER ASM-COVER/INSULAT	113302020003	1	1
12	HEATER & GUARD ASM	113301030011	1	1	1	1	.	.
13	DOOR-VENT	113302420001	1	1	1	1	1	1	1	1	1	1	1	1	1
NI	CLAMP-.750 (SNAP ON HUB)	883400080003	1	1	1	1	1	1	1	1	1	1	1	1	1
NI	GUIDE-VENT DOOR (U.S.)	111410500003	1	1	1	1	1	1	1	1	1	1	1	1	1

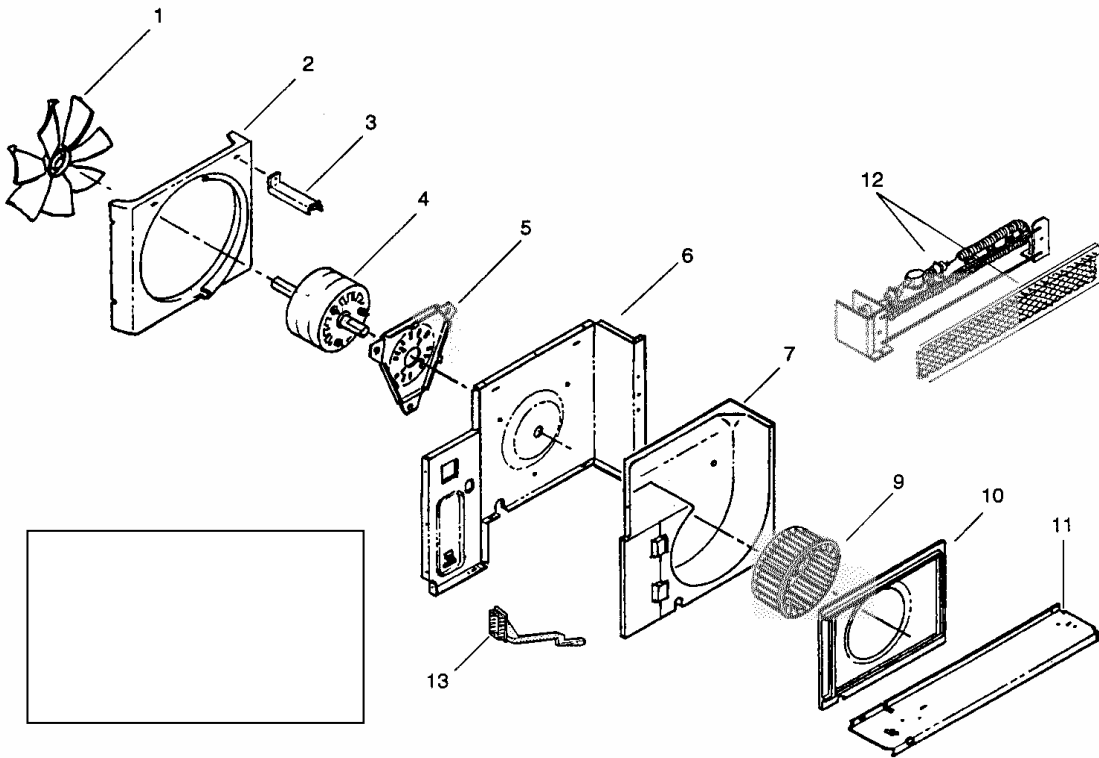

PARTS DIAGRAM

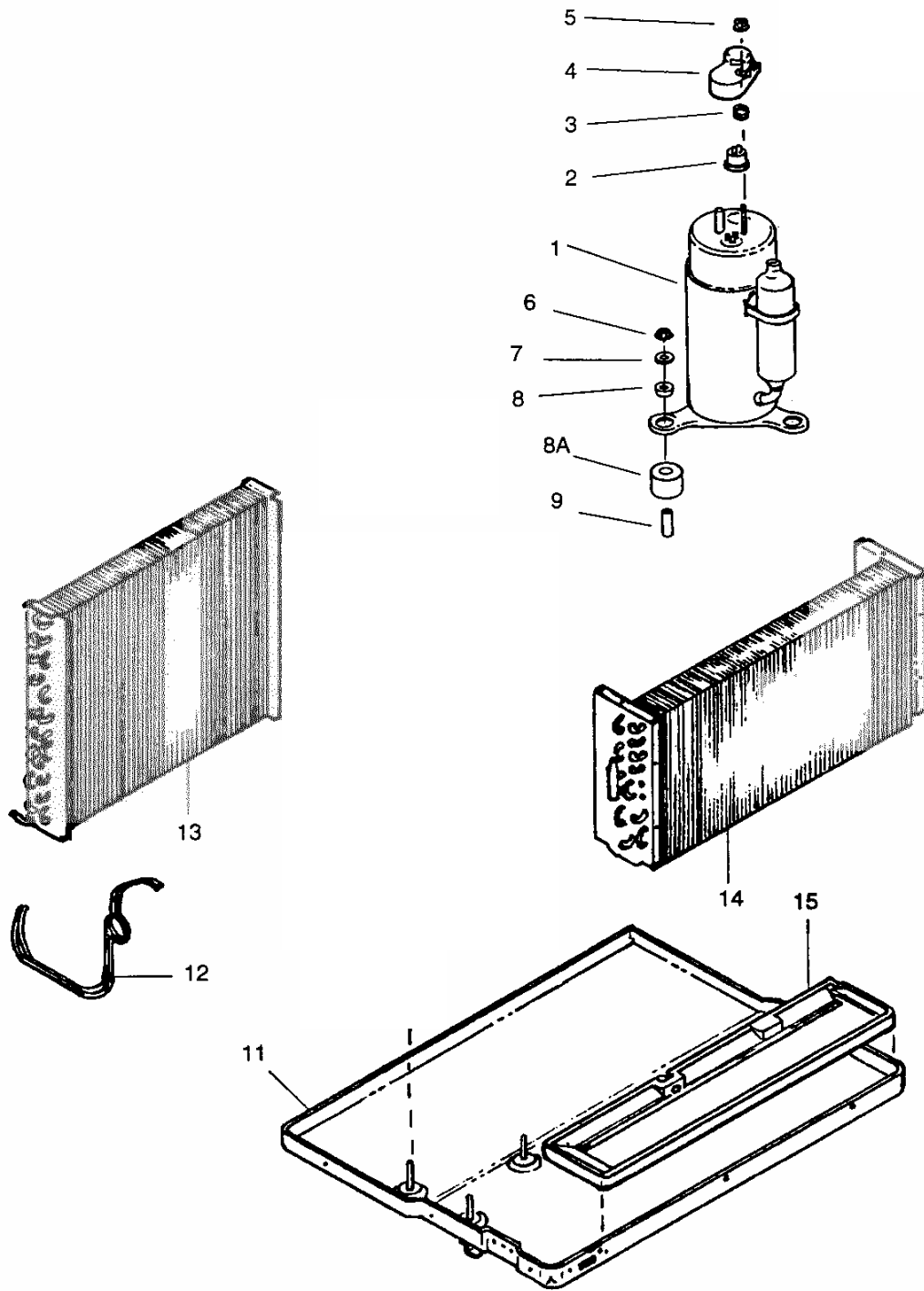

PARTS REFERENCE LIST

ITEM	DESCRIPTION	PART NO.	B-71B	B-71B	B-101B	B-101C	B-103B	B-103B	B-103B	BE-103C	BE-103C	BE-123B	BE-123C	B-123B	B-123C
			D	C	D	A	B	C	D	A	B	D	A	C	A
1	COMPRESSOR-RECHI, 7.2K	160201960006	.	1
1	COMPRESSOR-RECHI, 10K 230	160201920004	1	.	.	.	1
1	COMPRESSOR-SAMSUNG 7.2K	160201910004	1
1	COMPRESSOR-SANYO	160201850013	.	.	1	1
1	COMPRESSOR-SANYO	160201850019	1	1	1
1	COMPRESSOR-SANYO	160201850017	1	1	1	1
2	OVERLOAD-130/61-27	160300430105	1
2	OVERLOAD-155/70-22.5 AMP	160300430114	.	1
2	OVERLOAD-145/69/37	160300430123	.	.	1	1
2	OVERLOAD-145/75/18.0 AMP	160300430097	1	.	.	.	1
2	OVERLOAD-145/69/17	160300430135	1	1	1
2	OVERLOAD 150/69/21	160300430134	1	1	1	1
4	COVER-TERMINAL	160700580001	1
4	COVER-TERMINAL,RECHI COM	160700590001	.	1	.	.	1	.	.	.	1
4	COVER-TERMINAL	160700550001	1	1	1	1
5	NUT-#10-24 UNC-2B SANYO	160603280001	.	.	1	1	.	1	1	1	.	1	1	1	1
5	NUT-	160603430001	1
6	NUT-.313-18,"PALNUT"	882000230005
7	WASHER-.344 X1.00 X .067	112123340003	3	3
7	WASHER-.344 X1.125X .067	112123340002	.	.	3	3	3	3	3	3	3
8	GROMMET-BOT,COMPRESSOR	160603390003	3	3	.	.	3	3	3	3	3	3	3	3	3
8	GROMMET-BOT,COMPRESSOR	160603390006	.	.	3	3
8	GROMMET-TOP,FLAT 1.25X.3	160603390004	3	3	3	3	3	3	3	3	3	3	3	3	3
9	SLEEVE-.344X.438X1.78	160600710016	3	3	.	.	3	3	3	3	3	3	3	3	3
9	SLEEVE-.344X.438X1.563	160600710012	.	.	3	3
11	BOTTOM PAN ASM	113302070020	1	.	.	.	1	1	1	1	1
11	PAN-BOTTOM ASM	113302070022	1
11	BOTTOM PAN ASM	113302070024	1	1	1	1	.	.	1	1
12	CAPILLARY-.042X.112X35	S002C0002N08	2	2	2
12	CAPILLARY-.046X.098X27.5	S002C0002279	.	.	2	2	2	.	.	.	2
12	CAPILLARY-.049 X.098 X18.5	S002C0002144	1	1
12	CAPILLARY-.049X.098X41	S002C0002121	2	2	2	2
13	COND ASM-2R, 1/2 18FPI	113302100001	1	1
13	COND ASM, 3R, 1/2, 17FPI, 115V	113302110001	.	.	1	1
13	COND ASM-3R,1/2 17FPI, 230V	113302120001	1	1	1	1	1
13	COND ASM 4R 1/2 17FPI	113302130001	1	1	1	1

