

This Owner's Manual is provided and hosted by [Appliance Factory Parts](#).

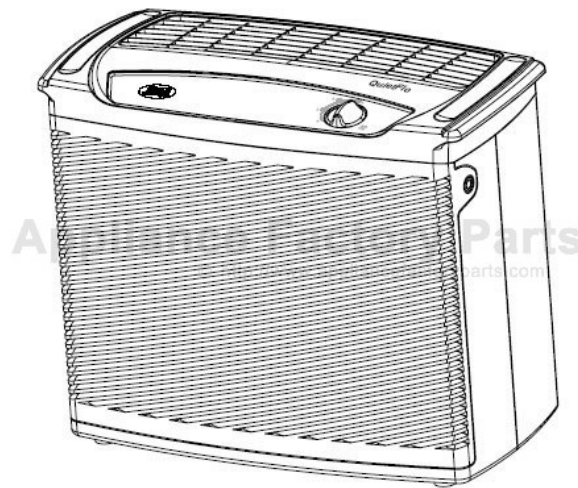

HUNTER 36115 Owner's Manual

[Shop genuine replacement parts for HUNTER 36115](#)



[Find Your HUNTER Air Cleaner Parts - Select From 138 Models](#)

----- Manual continues below -----

QuietFlo™

True HEPA Air Purifier

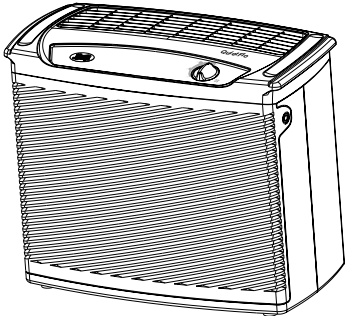

Models 36114 & 36115

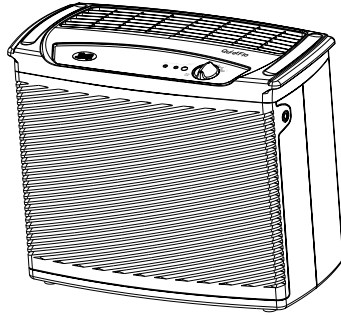

Models 36144 & 36145

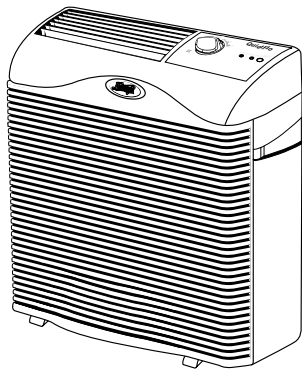

Models 36259 & 36260

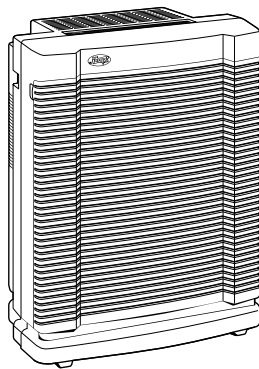

Models 36394 & 36395

English

Spanish

German

French

Italian

Danish

Dutch

Portuguese



IMPORTANT SAFETY INSTRUCTIONS

READ ALL INSTRUCTIONS BEFORE USING THIS AIR PURIFIER.

1. *This Air Purifier is designed for use on a flat, level surface and may not work properly on an uneven surface. ALWAYS place this Air Purifier on a firm, level surface. ALWAYS place the Air Purifier at least six (6) inches away from walls and heat sources such as stoves, radiators, or heaters.*
2. *Place the Air Purifier in an area that is out of the reach of children.*
3. *Before using the Air Purifier, extend the cord and inspect for any signs of damage. If the supply cord is damaged, it must be replaced by a manufacturer or its service agent or similarly qualified person in order to avoid hazard.*
4. *If the plug does not fit fully and securely into the outlet, reverse the plug. If it still does not fit, contact a qualified electrician. DO NOT attempt to use the unit unless the plug fits securely into the socket.*
5. *ALWAYS UNPLUG the Air Purifier when it is not in operation, while the filter is being changed, or while it is being cleaned.*
6. *DO NOT tilt or move the Air Purifier while it is in operation. Shut off and unplug before moving.*
7. *DO NOT immerse the Air Purifier in water, as permanent damage will occur. Refer to and follow the AIR PURIFIER MAINTENANCE instructions.*

READ AND SAVE ALL INSTRUCTIONS.

INTRODUCTION

Thank you for purchasing the QuietFlo™ True HEPA Air Purifier from Hunter Fan Company. You have purchased our latest development in portable Air Purification Systems. This system has been developed to improve the quality of the air you breathe.

Our QuietFlo™ True HEPA Air Purifier out performs other air purification systems by quickly and effectively removing dust, smoke, and pollen particles. The HEPA filter will remove 99.97% of particles 0.3 microns in size from air that passes through the filter.

The activated carbon pre-filter helps remove cooking, smoke, and pet odors from the air. It also traps lint, hair, and large particles, which helps improve the life and performance of the HEPA filter.

HOW THE QUIETFLO™ HEPA AIR PURIFIER WORKS

As the air is pulled into the purifier, the activated carbon pre-filter absorbs odors and catches large particles. Then, the air travels through the HEPA filter where the smaller particles are collected. Finally, the clean purified air is released back into the room.

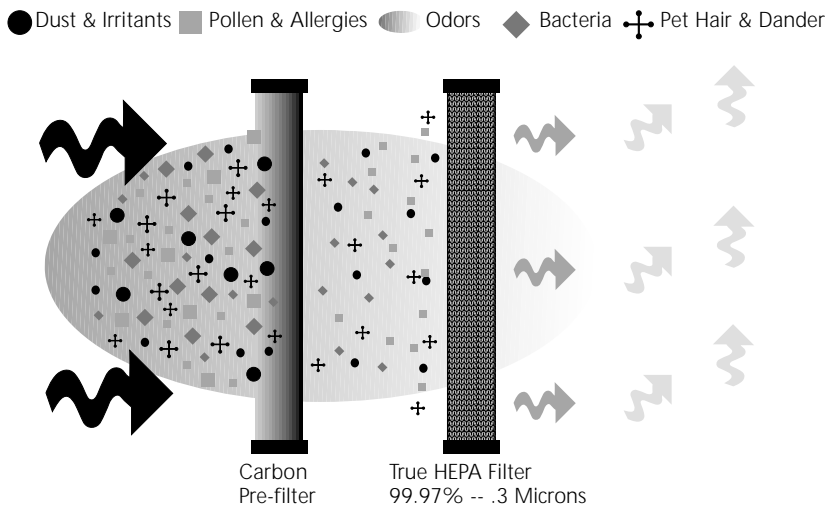

Figure 1- Illustration of the Air Filtration System



SETTING UP YOUR AIR PURIFIER

1. Remove your air purifier from the box and take it out of the clear plastic protective bag.
2. Place your QuietFlo™ Air Purifier on a firm, flat surface.
3. Before turning the Air Purifier ON, you need to open the front grille.
For Models 36114/36115/36144/36145: To release the front grille, press the tabs until the front grille slides easily over the tabs. Refer to Figures 2a on page 5.
For Models 36259/36260/36394/36395: To release the front grille, place your fingers behind the tabs and pull forward. Refer to Figures 3a and 3b on page 6.
4. The HEPA filter is already installed, but you should confirm that it has not shifted during shipment. Check the position of the HEPA filter by pressing firmly on all four corners to ensure that it is fully inserted into the filter opening.
5. The carbon pre-filter is mounted inside the front grille with hook tape. Confirm that it covers the grille vents. Refer to Figures 2b, 3c, and 3d on pages 5 and 6.
6. Find the filter installation reminder sticker on the inside edge of the front grille or unit. Circle the month and write the year of installation for the pre-filter and HEPA filter.
7. Replace the front grille. Be sure that the bottom grille tabs are in position first, and then push the top of the grille forward until it is closed. The unit is now ready for normal operation.
Note: The unit will not operate unless the door is placed in the correct position.
8. Plug the unit into the proper voltage outlet

Hunter Model No.	Rating
36114	
36144	
36259	120 V 60 Hz
36394	
<hr/>	
36115	
36145	
36260	220-240 V 50 Hz
36395	
<hr/>	

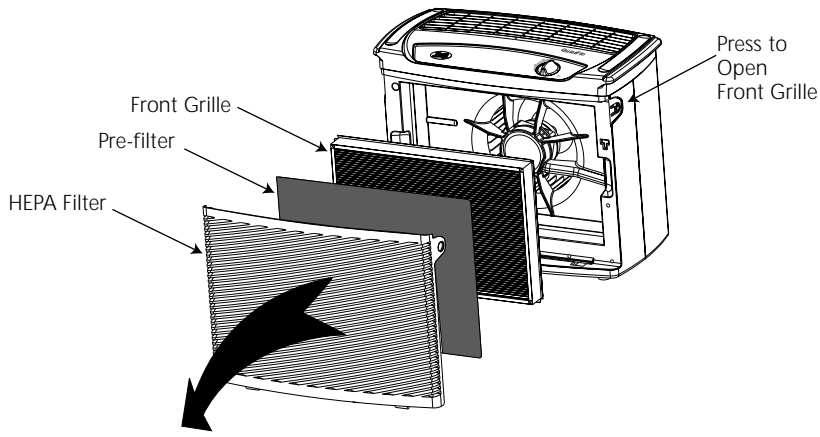

Figure 2a - Models 36114 & 36115

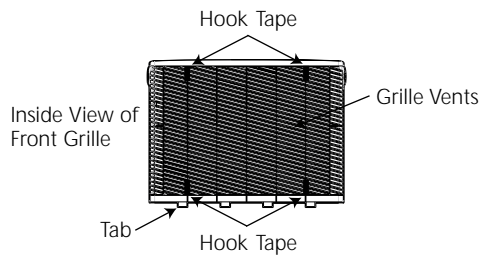

Figure 2b - Models 36114, 36115, 36144 & 36145

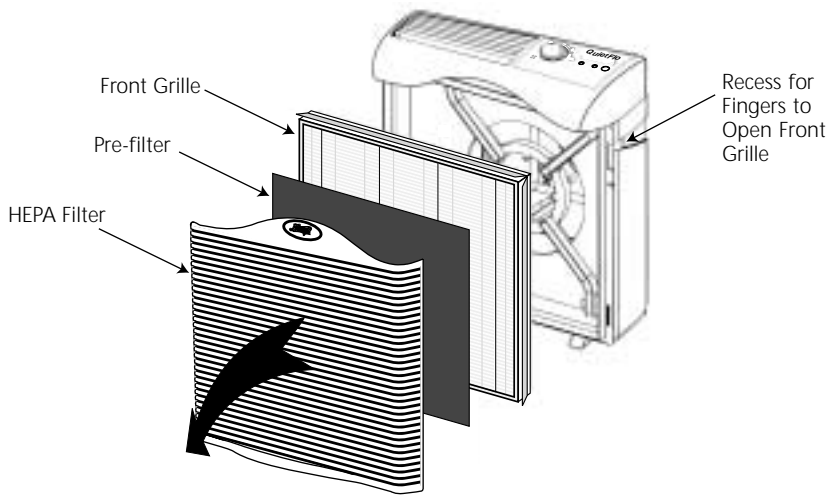

Figure 3a - Models 36259 & 36260

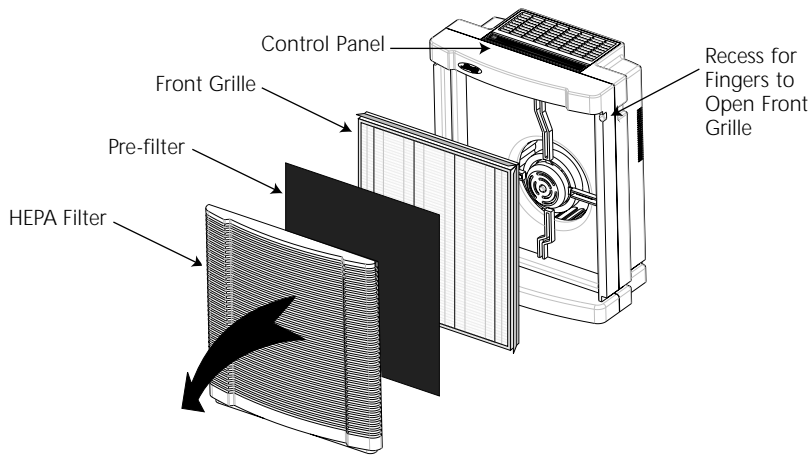

Figure 3b - Models 36394 & 36395

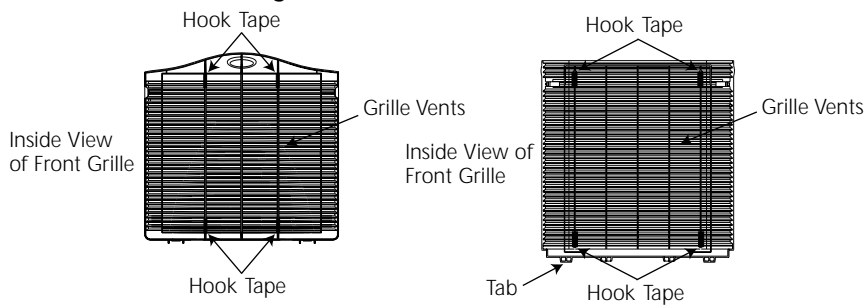

Figure 3c - Models 36259 & 36260

Figure 3d - Models 36394 & 36395





OPERATING YOUR AIR PURIFIER

Models 36114, 36115, 36144, 36145, 36259, 36260:

On/Speed Control: Rotate the Speed Control knob to set the desired speed. As you rotate the knob clockwise, the fan speed changes from off to low to medium to high. Turn the knob counter clockwise to decrease the fan speed or turn the unit off. The fan speed can be adjusted at any time.

Model 36394, 36395:

On/Speed Control: Press the On button () to turn the unit on. When you press it once, the fan speed will be at a setting of low (1). To switch to a speed setting of medium (2) or high (3), continue pressing the button.

Off: Press the Off button () to turn the unit off.

Timer: If you want the air purifier to shut off automatically, you can set the timer. Press the Timer button () to choose the amount of time you would like the air purifier to run (1, 2, 4, or 8 hours). Press the button repeatedly to change the length of time.

PRE-FILTER AND FILTER COUNTERS

Models 36144, 36145, 36259, 36260, 36394, 36395:

These air purifiers contain counters that indicate when the pre-filter and filter should be changed. The counter automatically counts the number of hours that each filter has been in use. When the pre-filter counter reaches 2000 hours (approximately three months of use), the pre-filter indicator will be lit to show that the pre-filter should be changed. When the HEPA filter counter reaches 8000 hours (approximately one year of use), the HEPA filter indicator will be lit to indicate that the filter should be changed. The exact life of the pre-filter and filter will depend upon the environment. If necessary, the filters should be changed more frequently.

To reset the pre-filter or filter counters when one indicator (or both) is lit:

1. Change the filter and/or pre-filter as described in the Maintenance section of the manual.
2. To reset the counter back to zero hours and turn off the indicator, press and hold the filter reset key for three seconds. If both the pre-filter and filter indicators are lit, the reset key will first turn off the pre-filter indicator. Then, you must release the reset key and then press and hold the filter reset key again for three seconds to turn off the filter indicator.

For Models 36394 and 36395: Use the tip of a pen or pencil to press the key.



To reset the pre-filter or filter counters before the indicators are lit:

In some environments, you may want to change the pre-filter or filter more frequently than indicated by the filter indicators. This procedure allows you to reset the pre-filter or filter counter before the indicators are lit.

1. Change the filter and/or pre-filter as described in the Maintenance section of the manual.
2. Now, you must choose which counter you want to reset. Press and hold the filter reset key (approximately three seconds) until the pre-filter indicator flashes. Press and release the reset key again to alternate between the two indicators. The counter that will be reset is designated by the flashing indicator.

For Models 36394 and 36395: Use the tip of a pen or pencil to press the key.

3. Once you have the correct indicator flashing, press and hold the reset key for three seconds to reset that counter to zero hours. The indicator will stop flashing when it has been reset. If needed, repeat these steps to reset the other counter.

AIR PURIFIER MAINTENANCE

CLEANING YOUR AIR PURIFIER

Proper maintenance of your Hunter Air Purifier will help ensure years of trouble free service. Follow these steps to properly maintain your air purifier:

1. Approximately every 90 days, the outside of the unit should be cleaned with a soft, damp cloth.
2. If needed, the front grille can be removed from the unit and cleaned with soapy water. Simply remove the pre-filter before exposing the grille to water.
3. Use the following instructions to determine when and how to replace the filter and pre-filters.

Notes:

- The air purifier should be unplugged during all cleaning processes.
- Be sure the unit is completely dry before plugging in and using.
- Never immerse the unit in water.



CHANGING THE PRE-FILTER

In a typical environment, the pre-filter should be changed every 2000 hours (approximately 3 months of use) to maintain proper odor-removing capability and overall filtration performance. Changing the pre-filter regularly will also help extend the life of the HEPA filter. If necessary, the pre-filter can be changed more frequently. The following instructions tell you how to change the pre-filter.

For Models 36144, 36145, 36259, 36260, 36394, 36395: The pre-filter indicator will flash after 2000 hours of use as a reminder that you should change the pre-filter.

1. Turn OFF and unplug the air purifier.
2. Remove the front grille to expose the pre-filter. The pre-filter is attached to the front grille with hook tape. Pull gently on the pre-filter to remove it. Once removed, you can dispose of the used pre-filter.
3. If needed, use a soft damp cloth to wipe off the front grille.
4. Remove the new pre-filter from the plastic wrapping and install it in the grille by pressing gently on the corners where it adheres to the hook tape. You may notice a few black particles coming off the pre-filter. Those particles are part of the odor-removing activated carbon and will be collected on the filter during normal use. Mark the new filter installation sticker included with the pre-filter and place the sticker on the front grille for future reference.
5. Install the front grille onto the unit and plug in the air purifier.
6. For Models 36144, 36145, 36259, 36260, 36394, 36395: Reset the pre-filter counter as described in the Pre-filter and Filter Counter section of this manual.

CHANGING THE HEPA FILTER

Although the proper time to change the filter depends on usage and the environment, a typical life is 8000 hours (approximately 1 year of usage). If you notice a decrease in air output or an increase in noise at any time during normal operation, the filter may be clogged and need to be replaced. A color-coded chart is also included on the inside of the housing to help you determine if it is time to change the HEPA filter. Follow these instructions to change the HEPA filter.

For Models 36144, 36145, 36259, 36260, 36394, 36395: The filter indicator will flash after 8000 hours of use as a reminder that you should change the filter.

1. Turn OFF and unplug the air purifier.
2. Remove the front grille and gently pull on the filter to remove it from the unit. While removing the filter, note the direction of the flaps that form the seal around the filter. The new filter will be installed



with the same orientation. Once removed, the used filter can be discarded.

3. Remove the new filter from its wrapping and look at the orientation of the rubber seals on the sides of the filter. The loose ends of the flaps should be facing out as the filter is placed into the air purifier. Press firmly on the filter frame to ensure that the filter is fully inserted into the housing. Mark the new filter installation sticker included with the filter and place the sticker on the front grille for future reference.
4. Install the front grille onto the unit and plug in the air purifier.
5. For Models 36144, 36145, 36259, 36260, 36394, 36395: Reset the filter counter as described in the Pre-filter and Filter Counter section of this manual.

REPLACEMENT FILTERS:

To obtain replacement filters for your Air Purifier, contact your local retailer where the unit was purchased. Please be prepared to tell the retailer the model number of your air purifier and the model number of your replacement filters that are listed below. The model number of your air purifier is located on the rating sticker on the back of the unit. The replacement filter model numbers are listed in the table below.

Air Purifier Model No.	Pre-filter Model No.	HEPA Filter Model No.
36114 36115 36144 36145	30907	30938
36259 36260	30903	30940
36394 36395	30907	

ELECTRICAL CORD STORAGE

Models 36114, 36115, 36144, 36145:

For your convenience, this air purifier has cord wrap posts for easy storage of the electrical cord. The cord wrap posts are located on the back of the air purifier in the bottom corners.

When received, the cord wrap posts will be in the collapsed position. To extend the cord wrap posts, simply twist approximately 1/8 of a rotation and gently pull outward. The post will extend approximately 0.5 inches (refer to Figure 4). Once extended, wrap the cord around the two posts until the desired length is obtained.

English

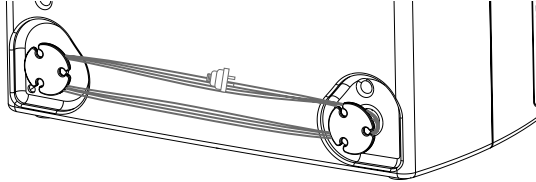

Figure 4 - Extended Cord Wrap Posts

Hunter Fan Company
2500 Frisco Avenue
Memphis, Tennessee 38114
United States of America
<http://www.hunterfan.com>