

This Owner's Manual is provided and hosted by [Appliance Factory Parts](#).



HEAT CONTROLLER B-VMH18SB Owner's Manual

[Shop genuine replacement parts for HEAT
CONTROLLER B-VMH18SB](#)

[Find Your HEAT CONTROLLER Air Conditioner Parts - Select From 32 Models](#)

----- Manual continues below -----

HEAT CONTROLLER, INC.

**Wall Mounted
Mini-Split System
Inverter Single-Zone
Air Conditioning/Heat Pump**

Service Manual

**Model: AS-W1835JZ0[VMH18SB-1]
AS-W2435JZ0[VMH24SB-1]**

CAUTION

Before servicing the unit, read the
“safety precautions” in this manual.

Only for authorized service personnel.

1. Specification

Models		AS-W1835JZO [VMH18SB-1]	AS-W2435JZO [VMH24SB-1]
Cooling Capacity (Min~Rating~Max)	kW	1.76~5.28~5.80	3.87~7.03~7.74
	Btu/h	6,005~18,000~19,790	13,200~24,000~26,400
Heating Capacity (Min~Rating~Max)	kW	1.40~6.07~6.65	3.37~8.00~8.88
	Btu/h	4,776~20,700~22,690	11,500~27,300~30,300
Power Input	Cooling/Heating	W	1640/1770
Running Current	Cooling/Heating	A	7.3/8.3
Starting Current	Cooling/Heating	A	7.3/8.3
EER		W/W	3.22
		Btu/h.W	11
COP		W/W	3.43
Power Supply		Ø / V / Hz	1/208-230/60
Power Factor		%	98
Air Flow Rate	Indoor,Max	mm³/min(cfm)	18.5(650)
	Outdoor,Max	mm³/min(cfm)	42(1,483)
Moisture Removal		l/h	2.1
Sound Level	Indoor,H/M/L	dB(A)+3	40/38/34
	Outdoor,Max	dB(A)+3	53
Refrigerant & Charge(at 7.5m)		g(oz)	R410A, 1,200(42)
Additional Refrigerant Charge		g/m(oz/ft)	20(0.22)
Compressor	Type		Rotary
	Model		5CS130XCA03
	Motor Type		BLDC
	Oil Type		RB68A
	Oil Charge	cc	360
	O.L.P Name		-
Fan(Indoor)	Type		Cross Flow Fan
	Motor Output	W	20
Fan(outdoor)	Type		Propeller
	Motor Type		BLDC
	Motor Output	W	85.3
Circuit Breaker*		A	20
Power Supply Cable		NEC	14
Power and Transmission Cable		NEC	18
Piping	Liquid Side	mm(in)	6.35(1/4)
Connections	Gas Side	mm(in)	12.7(1/2)
Drain Hose	O.D. / I.D	mm(in)	21.5,16(0.85,0.63)
Dimension	Indoor(W*H*D)	mm	1,090*300*178
		inch	42.9*11.8*7.0
	Outdoor(W*H*D)	mm	870*655*320
		inch	34.3*25.8*12.6
Net Weight	Indoor	kg(lbs)	13.0(28.7)
	Outdoor	kg(lbs)	48(105.8)
Operation Range	Cooling(Outdoor)	°C	-10 ~ 46 (14.0/114.8)(Low Ambient)
	Heating(Outdoor)	°C	-10 ~ 24 (14.0 ~ 75.2)
Max. Piping Length		m(ft)	15(49)
Max. Elevation Difference		m(ft)	7(23)
Tool Code(Chassis)	Indoor + Outdoor		S8 + UE
Functions	Temperature Control		Thermistor
	Plasma Filter		-
	Prefilter(washable/anti-fungus)		O
	Auto Clean		O
	CHAOS Wind(Auto Wind)		O
	Steps, Fan/Cool/Heat		-/4/4
	Airflow Direction Control(up&down)		Auto
	Airflow Direction Control(left&right)		Auto
	Remocon Type		Wireless LCD
	Setting Temperature	Cooling	18 ~ 30 (64/86)
	Range	Heating	16 ~ 30 (60~86)
	Auto Operation (Micom Control)		-
	Auto Changeover (Micom Control)		O
	Self Diagnosis		O
	Timer		24h On/Off
	Sleep Operation		O
	Soft Dry Operation		O
	Restart Delay(minute)		2
	Deice Control(Defrost)		O
	Hot Start		O
	Jet Cool / Heat		O / O
	Low Ambient Operation		O
	Special Function		-
Network Functions	Dry Contact		-
	Network Solution(LGAP)		-
	PI485		-

Note:

O : Applied, - : No relation

* For circuit breaker rating, please conform to local standards wherever necessary.

* Some of functions are slightly different depending upon models.

* The specification may be subject to change without prior notice for purpose of improvement.

* Capacity : based on 203V.

2. Piping Diagrams

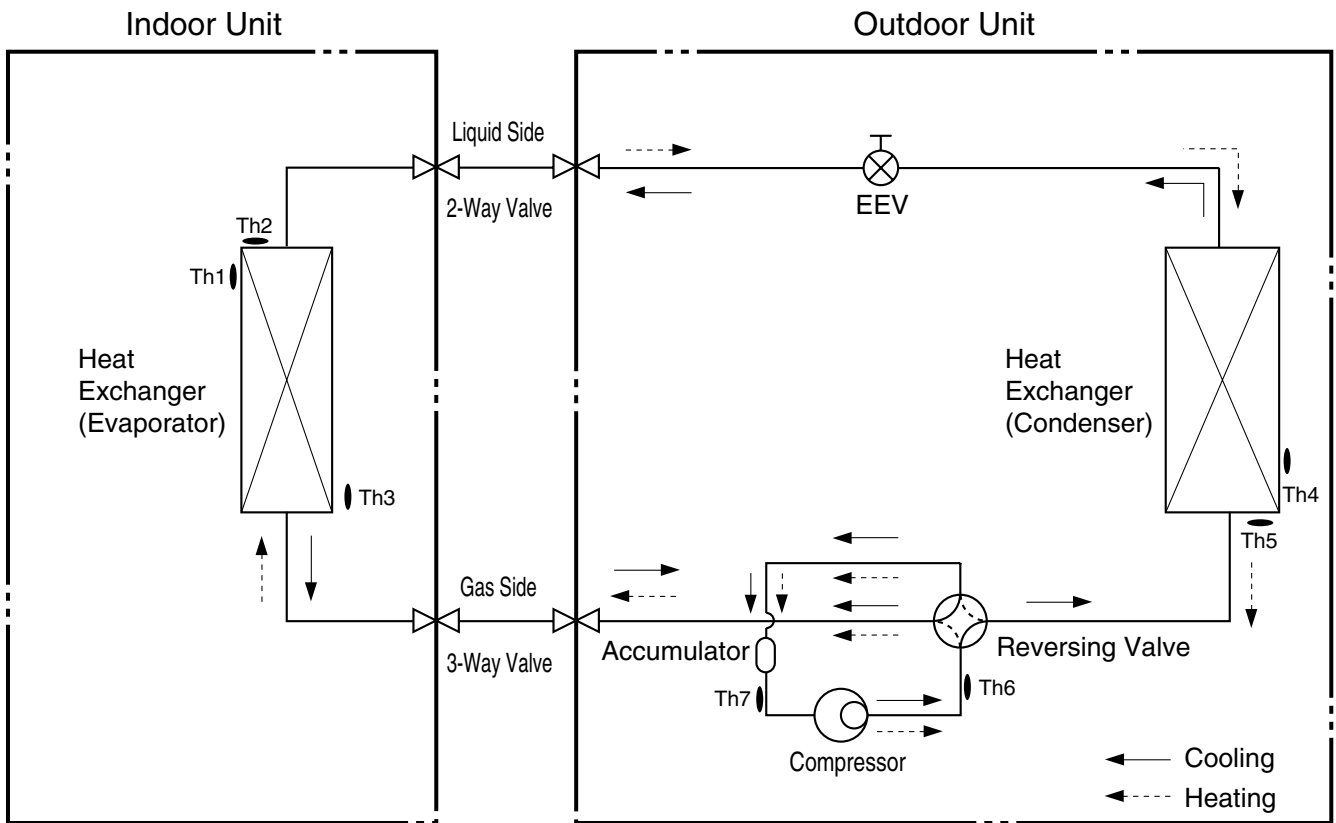

LOC.	Description	PCB Connector
Th1	Thermistor for indoor air temperature	CN_TH1(INDOOR)
Th2	Thermistor for evaporating temperature	CN_TH2(INDOOR)
Th3		CN_TH3(INDOOR)
Th4	Thermistor for outdoor air temperature	CN_TH2(OUTDOOR)
Th5	Thermistor for condensing temperature	
Th6	Thermistor for discharge pipe temperature	CN_TH3(OUTDOOR)
Th7	Thermistor for suction pipe temperature	

3. Wiring Diagrams

Indoor Unit

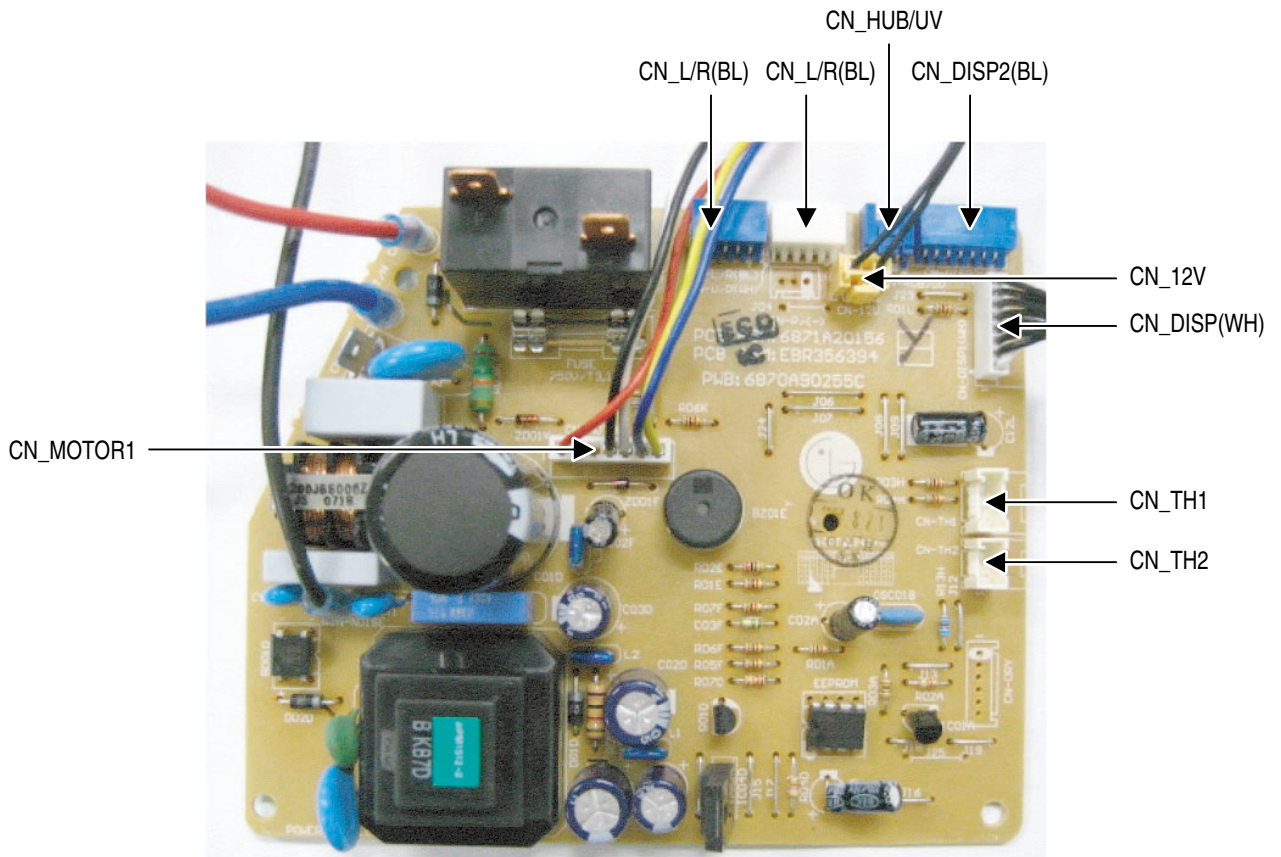
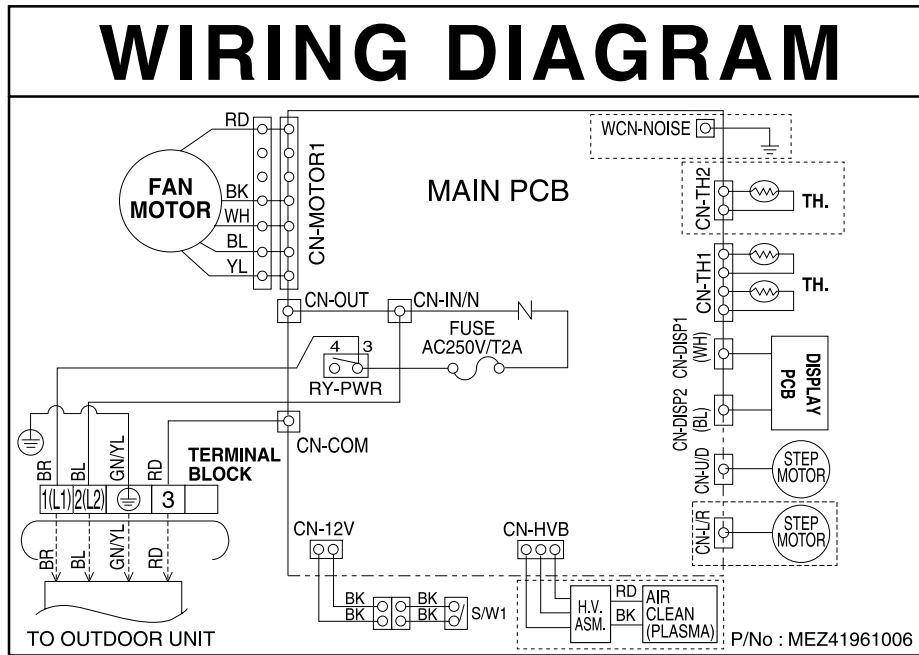

Outdoor Unit

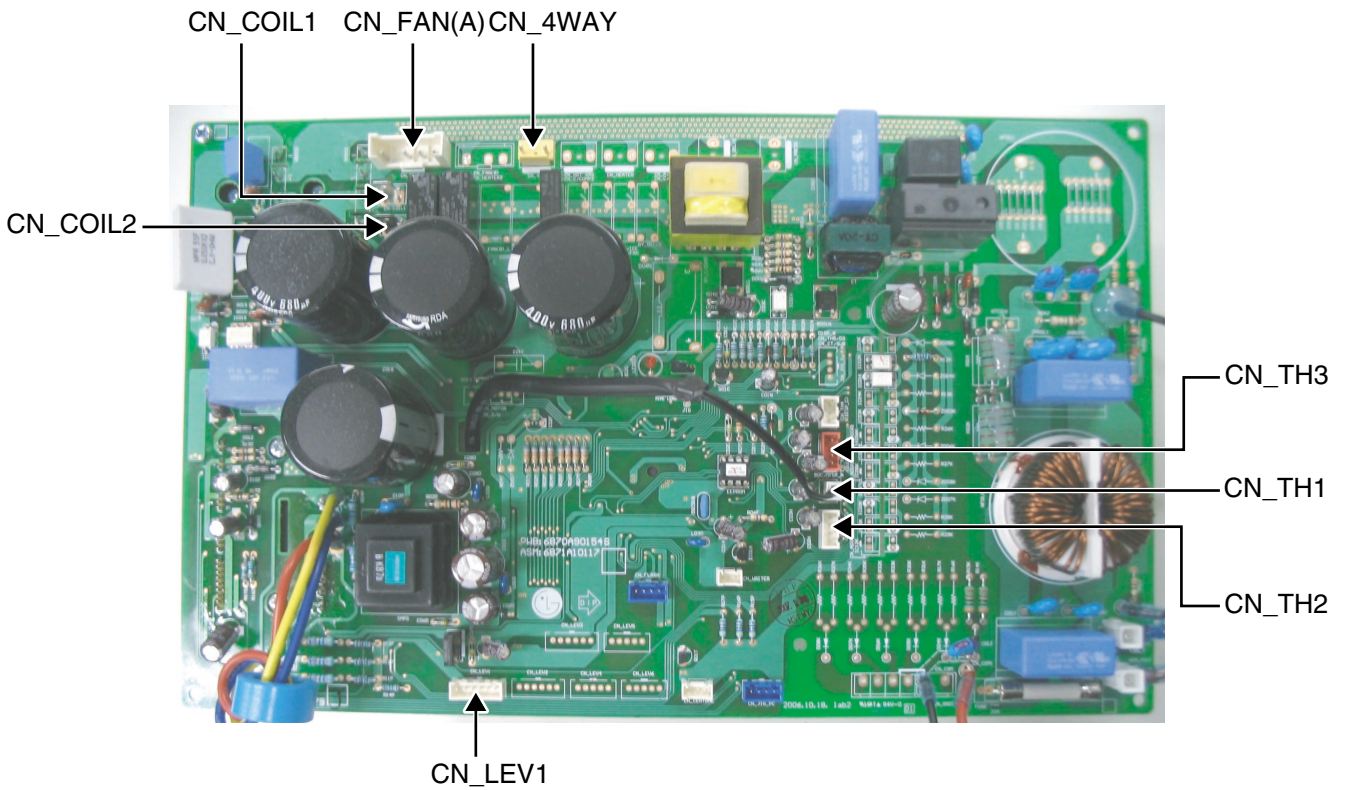
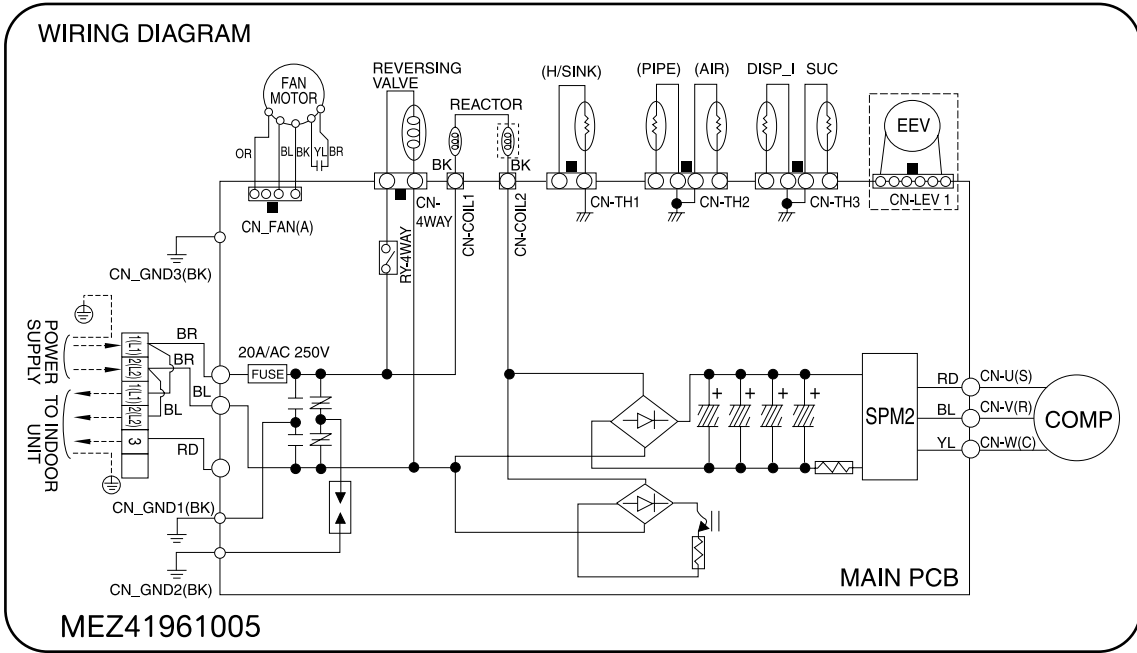

4. Exploded View

Indoor Unit

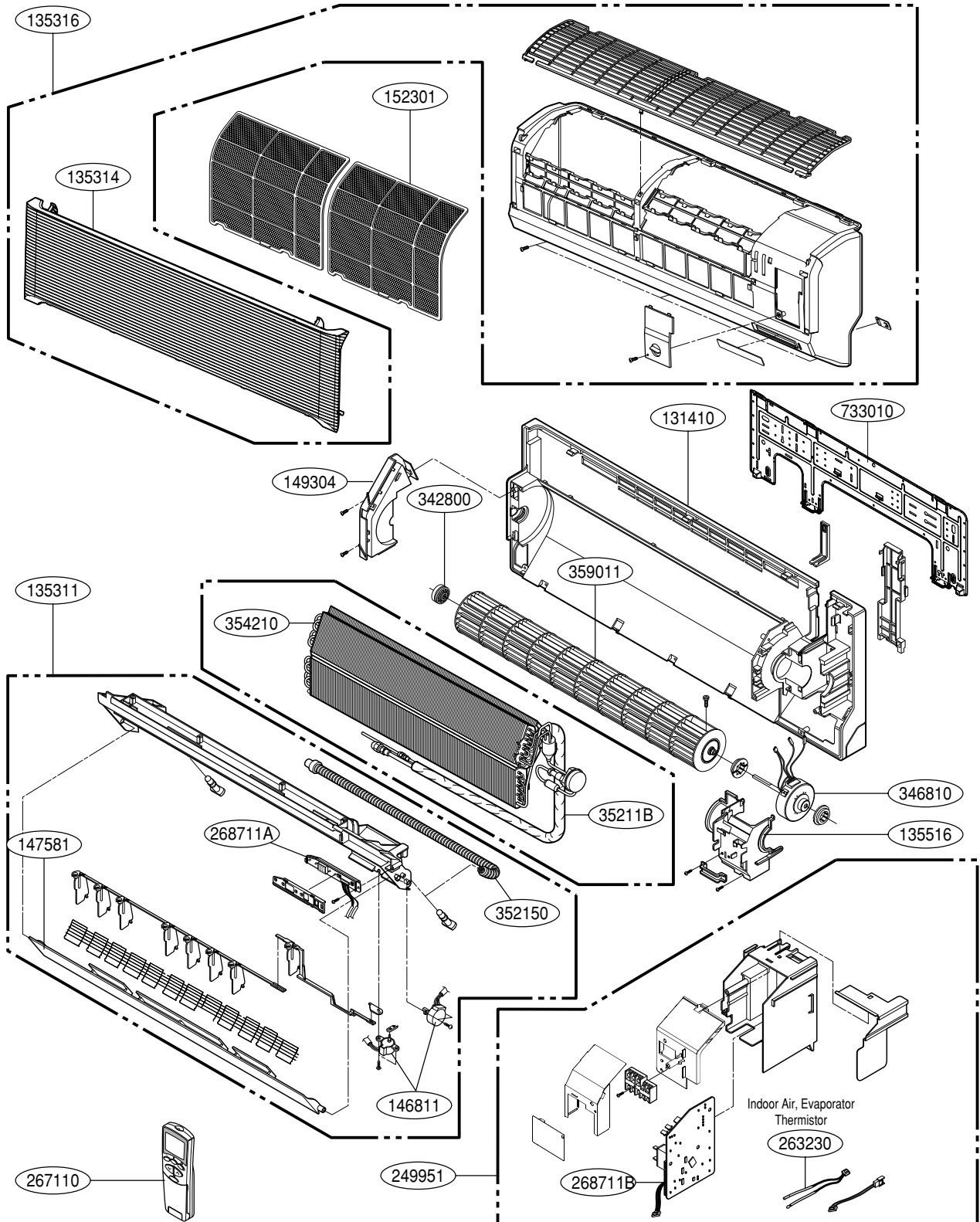

Note) * Please ensure GCSC since the replacement parts may be changed depending upon the buyer's request.
Please check the correct parts in View RPL(Replacement Part List) on GCSC.
(GCSC Website <http://biz.lgservice.com>.)

Outdoor Unit 18k

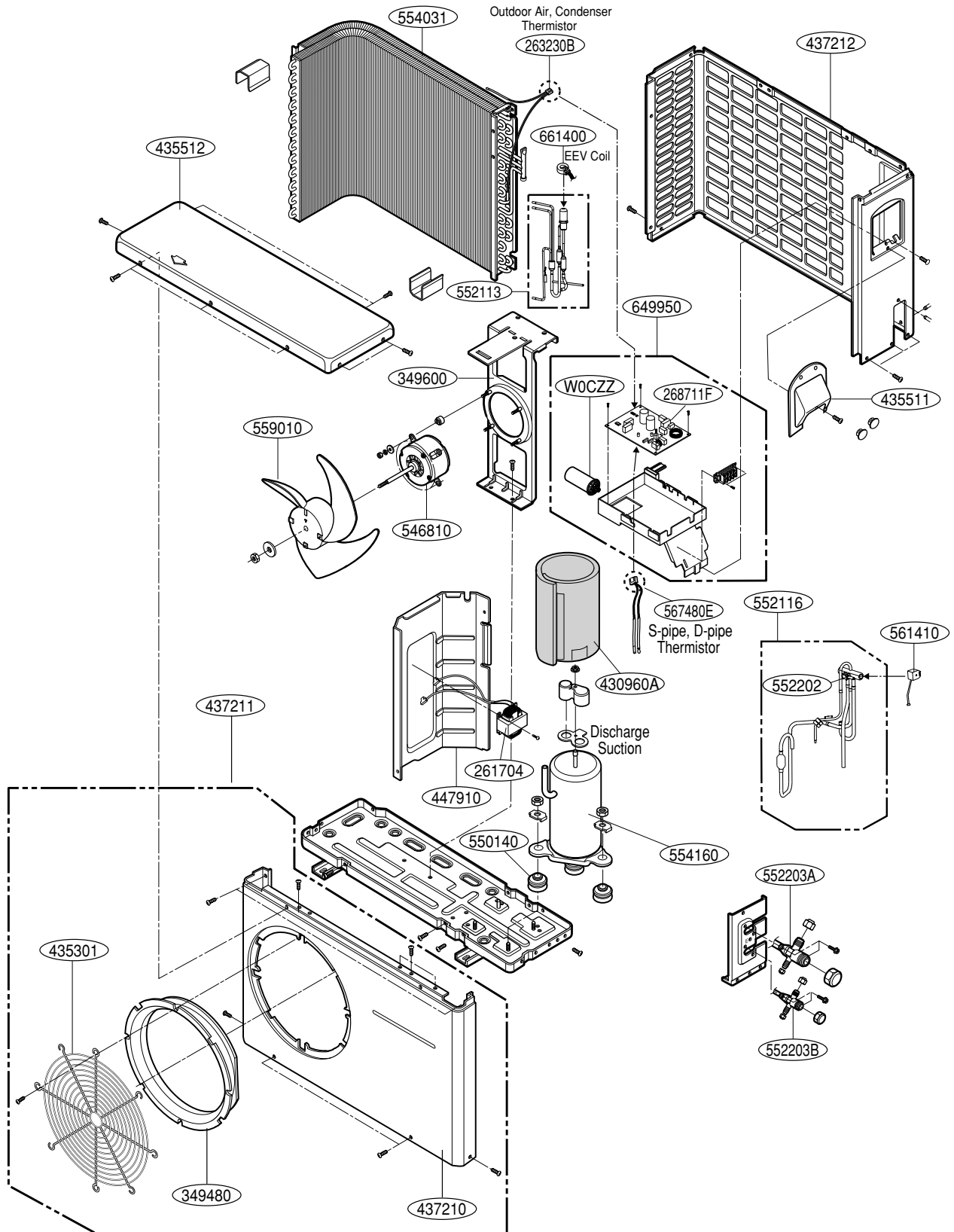

Note) * Please ensure GCSC since the replacement parts may be changed depending upon the buyer's request. Please check the correct parts in View RPL(Replacement Part List) on GCSC. (GCSC Website <http://biz.Lgservice.com>.)

Outdoor Unit 24k

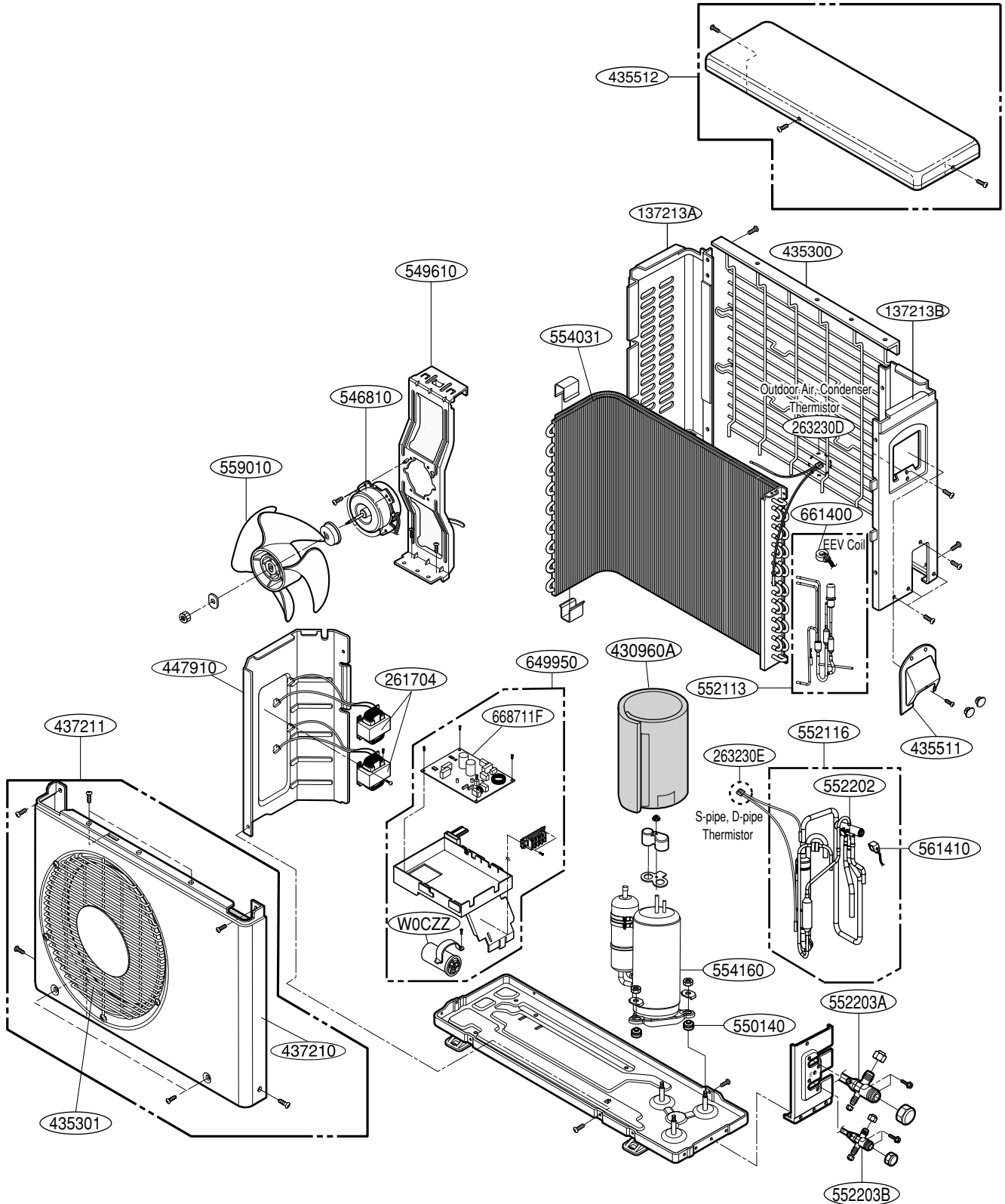

Note) * Please ensure GCSC since the replacement parts may be changed depending upon the buyer's request. Please check the correct parts in View RPL(Replacement Part List) on GCSC. (GCSC Website <http://biz.Lgservice.com>.)

Specifications and performance data subject to change without notice.

HEAT CONTROLLER, INC.

1900 WELLWORTH AVENUE • JACKSON, MICHIGAN 49203

THE QUALITY LEADER IN CONDITIONING AIR

P/No.:MFL42286409