

This Owner's Manual is provided and hosted by [Appliance Factory Parts](#).

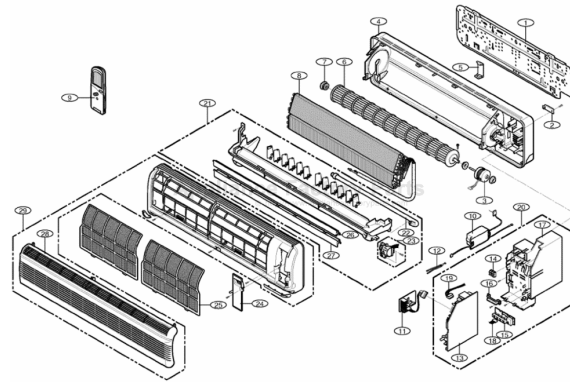

LG AG1AC23BWI Owner's Manual

[Shop genuine replacement parts for LG AG1AC23BWI](#)



[Find Your LG Air Conditioner Parts - Select From 2328 Models](#)

----- Manual continues below -----

Product Specifications (Cooling Only)

Item		Model Name		AG1AC17BWF/G/I	AG1AC23BWF/G/I	AG1AC17BKM	AG1AC23BKM
		Unit					
Cooling Capacity		BTU/h		17,000	23,000	17,300	23,000
Moisture Removal		g/h		2.5	3.1	2.5	3.1
Power Source		Ø, V, Hz		1Ø, 220-240V, 50Hz		1Ø, 220V, 60HZ	
Air Circulation	Indoor	m³/min		12.1	15	13	15
	Outdoor			42			
Noise Level	Indoor	dB(A)		45; 2	48; 2	46; 2	48; 2
	Outdoor			55; 3	57; 3	56; 3	57; 3
Input		W		1,950	2,400	2,000	2,700
Runnig Current		A		9.3	11.5	9.0	12.0
E.E.R.		BTU/h-W		8.7	9.6	8.6	8.7
Motor Output	Indoor	W		Max. 45 (BLDC MOTOR)			
	Outdoor			62			
Dimensions (W x H x D)	Indoor	mm		1,080 x 290 x 183			
	Outdoor			870 x 655 x 320			
Net. Weight	Indoor	kg		12			
	Outdoor			60	64	62	
Refrigerant(R-22)		g		900	2,000	1,430	1,950
Airflow Direction Control (Up & Down)				YES			
Deicer				NO			
Hot Start				NO			
Auto Wind				YES			
Micom Dry				YES			
Timer				24hr ON/OFF			
Self Diagnosis				YES			
Remocon type				L.C.D Wireless			
Service valve	Liquid		1/4"(6.35)				
	Gas		1/2"(12.7)	5/8"(15.88)	1/2"(12.7)	5/8"(15.88)	
Sleeping Operation				YES			
Drain Hose				YES			
Connecting Cable				0.75mm²			
Power Cord				2.5mm²			

Product Specifications (Cooling & Heating)

Model Name		AG1AH17BWF/G/I	AG1AH23BWF/G/I
Item	Unit		
Cooling Capacity	BTU/h	17,000	23,000
Heating Capacity		18,500	23,000
Moisture Removal	g/h	2.5	3.1
Power Source	Ø, V, Hz	1Ø, 220-240V, 50Hz	
Air Circulation	Indoor	12.1	15
	Outdoor	42	
Noise Level	Indoor	45±2	48±2
	Outdoor	55±3	57±3
Input	Cooling	1,860	2,400
	Heating	1,950	2,400
Runnig Current	Cooling	8.8	11.5
	Heating	9.2	11.5
E.E.R.	Cooling	8.7	9.6
C.O.P	Heating	2.8	2.8
Motor Output	Indoor	Max. 45(BLDC MOTOR)	
	Outdoor	62	
Dimensions (W x H x D)	Indoor	1,080 x 290 x 183	
	Outdoor	870 x 655 x 320	
Net. Weight	Indoor	12	
	Outdoor	62	65
Refrigerant(R-22)	g	1,270	1,630
Airflow Direction Control (Up & Down)		YES	
Deicer		YES	
Hot Start		YES	
Auto Wind		YES	
Micom Dry		YES	
Timer		2hr ON/OFF	
Self Diagnosis		YES	
Remocon type		L.C.D Wireless	
Service valve	Liquid	1/4"(6.35)	
	Gas	1/2"(12.7)	5/8"(15.88)
Sleeping Operation		YES	
Drain Hose		YES	
Connecting Cable		0.75mm ²	
Power Cord		2.5mm ²	

Dimensions

(1) Indoor Unit

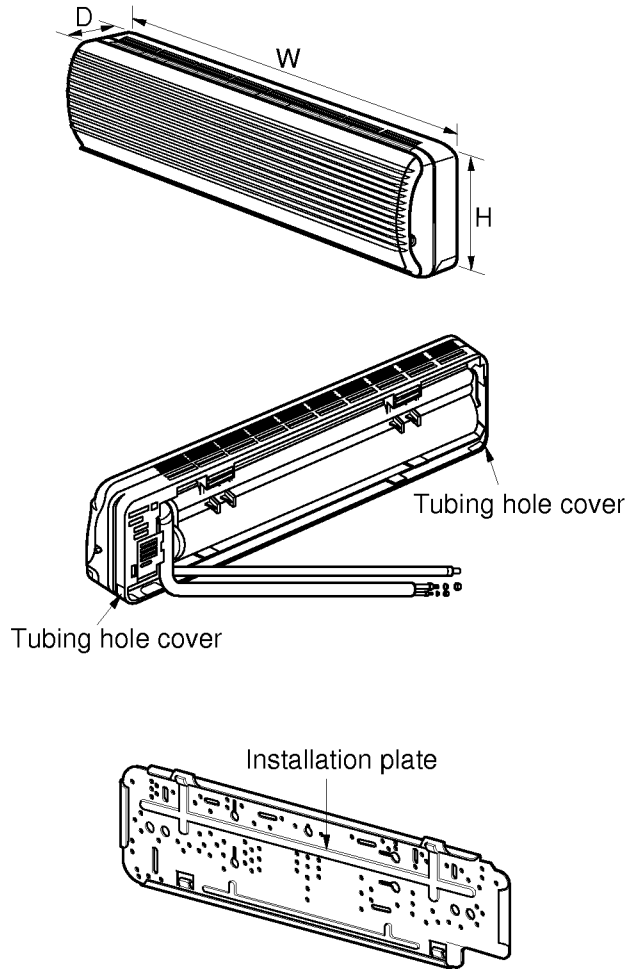

DIM \ MODEL		ALL MODELS
W	mm	1,080
H	mm	290
D	mm	183

(2) Outdoor Unit

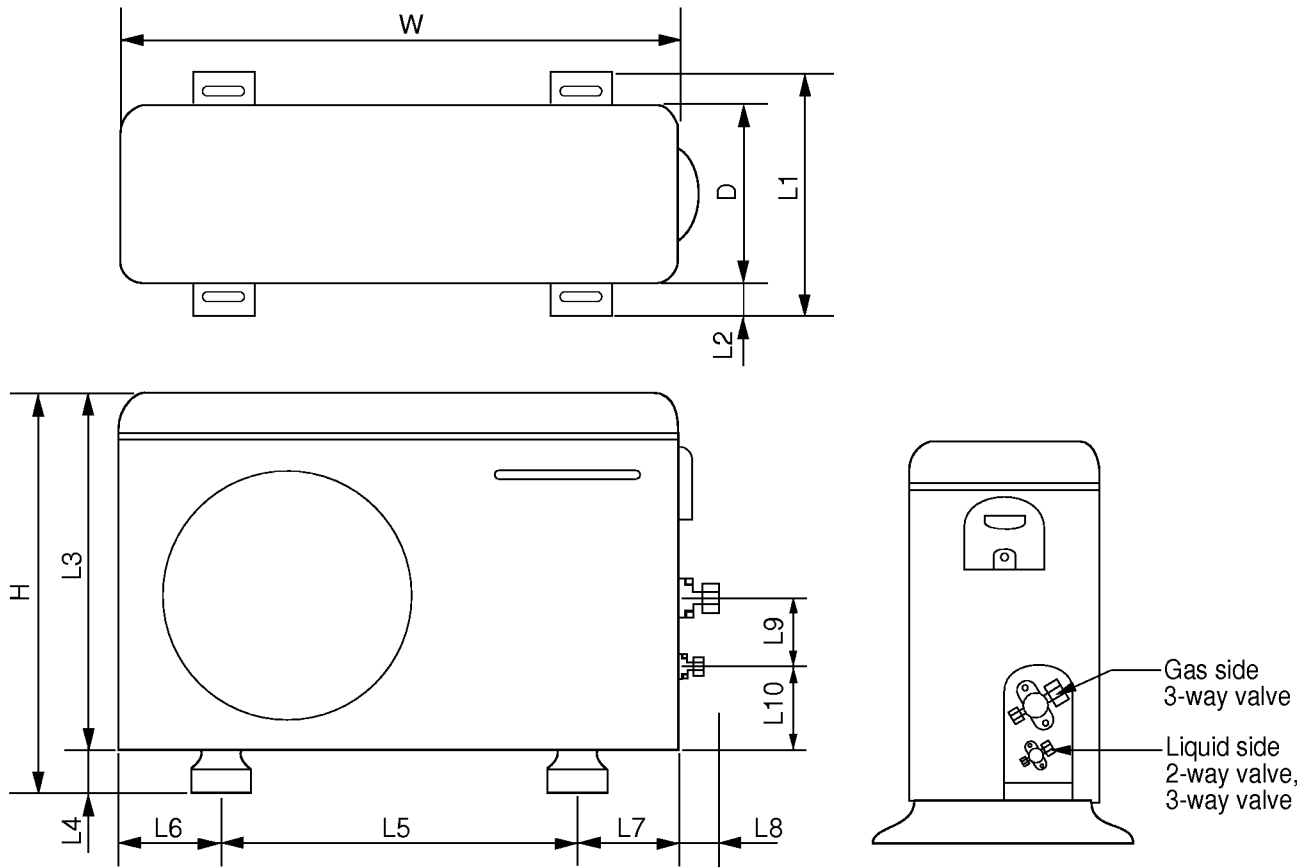

MODEL		ALL MODELS	
DIM			
W	mm	870	
H	mm	655	
D	mm	320	
L1	mm	370	
L2	mm	25	
L3	mm	630	
L4	mm	25	
L5	mm	546	
L6	mm	162	
L7	mm	162	
L8	mm	54	
L9	mm	74.5	
L10	mm	79	