

This Owner's Manual is provided and hosted by [Appliance Factory Parts](#).

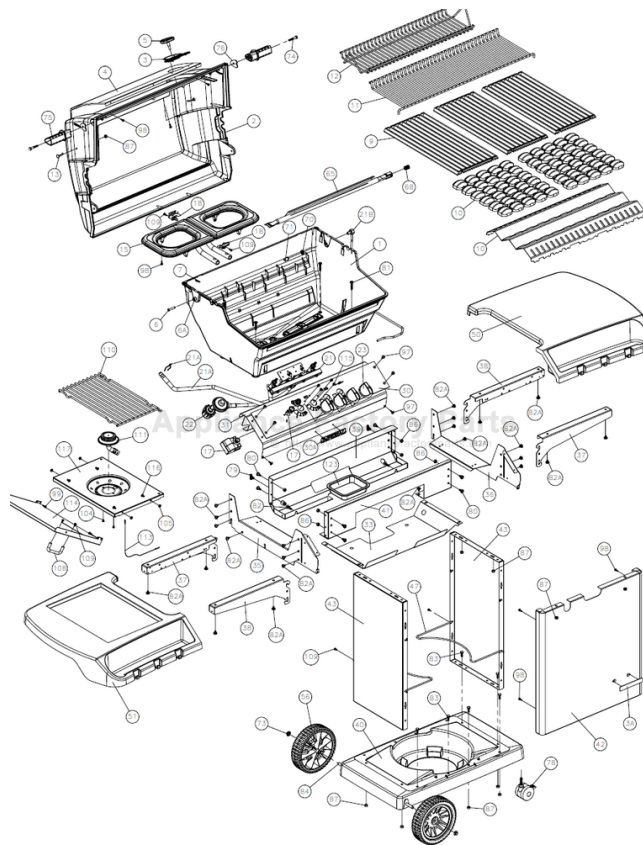

Broil King 969-24 Owner's Manual

[Shop genuine replacement parts for Broil King 969-24](#)



[Find Your Broil King Grill Parts - Select From 1350 Models](#)

----- Manual continues below part list -----

Available Replacement Parts for Broil King 969-24

03200	spark generator; Bmstr, DCS, Ducane
04200	electrode
18434	INFINITY BURNER T501
10892-8NG	WHEEL 8 INCH GREY WALL
10225-T628	GRID FLAT WARMING RACK DELUXE+
10225-T627	GRID SWING BASKET IMPERIAL BLACK
10225-T528	GRID FLAT WARM RACK T50 PORC +
03230	spark generator; Ducane
18488	FLAV-R-WAVE - 50,000 BTU STAINLESS
11115	CI COOKING GRID - T626
10342-T301	IGNITOR ELECTRODE ASSEMBLY 8 BURNER 1993
10711-r562	SHELF LEFT C LG W/O BRACKET +
10222-T626	GRATE FLAV R CAST IMPERIAL +
18013	LARGE PROBE HEAT INDICATOR
10184-R19	TANK RETAINER-PEDESTAL-NEW
10225-T10	GRID PORCELAIN S/B
10393-K40	SIDE BURNER COVER 1.86
10081-BK630	NAMEPLATE HI BROIL KING BLACK ZINC
10240-15	HINGE PIN SIDE SHELF DROP DOWN
S21237	HINGE PIN SPACER
10110-91	TUBE R/B ASSY COMPR FITTING
10892-15	CASTER 2 1/2 INCH WHEEL KNURLED
S15171	AXLE PLTD 3/8x18 9/16 PED +
S21124	SCREW PHCP #8 X 12 +
PB20-60A	S/B LID HANDLE WAGON ENCLOSER+ W/SCREWS
10390-E10	BURNER SIDE 10BTU W/ELEC #8 +
10342-T14	WIRE ELECTRODE S/B FLAT/ROUND+
10393-R50	SIDE BURNER BODY 2002 +
10239-7	HANDLE GASKET TRIANGULAR 1/8
50416	SMALL DRIP PAN - 10 PACK

538S2	grid, 304 ss oem style, 17.3125 x 23.5;
02342	control knob; universal
10342-246	IGNITOR ELECTRONIC TRIPLE +
10184-R80	RADIATION SHIELD RAW
S13005A	BURNER TUBULAR W/IGNITION
10696-127	R/B ORIFICE LP
10696-185	R/B ORIFICE NG 1.85MM
10909-T50	CASTING BOTTOM 52M 2002 +
10473-T50	CASTING TOP 52M
10081-BK611	NAMEPLATE REGAL ZINC DIE CAST
10184-K651	SUPPORT CASTING LEFT
Y-11797	BOLT SWING BASKET #D
10184-R581	SHELF SUPPORT LFT BLK(18 INCH)
10184-R591	SHELF SUPPORT RH BLK(18 INCH)
66162	grid, ci, 17.125 x 24.875; Grill Chef
10472-k40	KNOB ROTARY IGNITOR #B
80012	regulator and hose READ ADD. INFO
10342-245	IGNITOR ELECTRONIC DUAL +
10958-E71	PEDESTAL RESIN BASE LRG +
11124	EXACT FIT CAST GRID
10111-K45	HOSE 3/8 INCH ASSEMBLY NG 10 FOOT +
Y-11990	NUT HEX BRASS 3/8 27 RB LINE

Broil King®

REDDI-BILT BARBECUES

ASSEMBLY MANUAL & PARTS LIST

MANUEL DE MONTAGE & LISTE DE PIÈCES

Broil King®

REGAL 70
958-74
958-77



Broil King®

REGAL 90
958-94
958-97

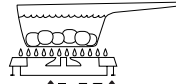

Broil King®

IMPERIAL 20
969-24
969-27



Broil King®

IMPERIAL 40
969-44
969-47

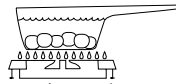

Broil King®

IMPERIAL 70
969-74
969-77



Broil King®

IMPERIAL 90
969-94
969-97

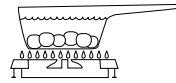

Broil King®

SIGNET 50
5818-4
5818-7



Broil King®

SIGNET 80
5848-4
5848-7

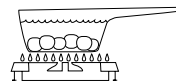

RETAIN FOR FUTURE REFERENCE

VEUILLEZ CONSERVER POUR REFERENCE ULTERIEURE

Onward
MANUFACTURING COMPANY LIMITED
SINCE 1906
585 KUMPF DRIVE
WATERLOO, ONTARIO, CANADA
N2V 1K3

1

(2)

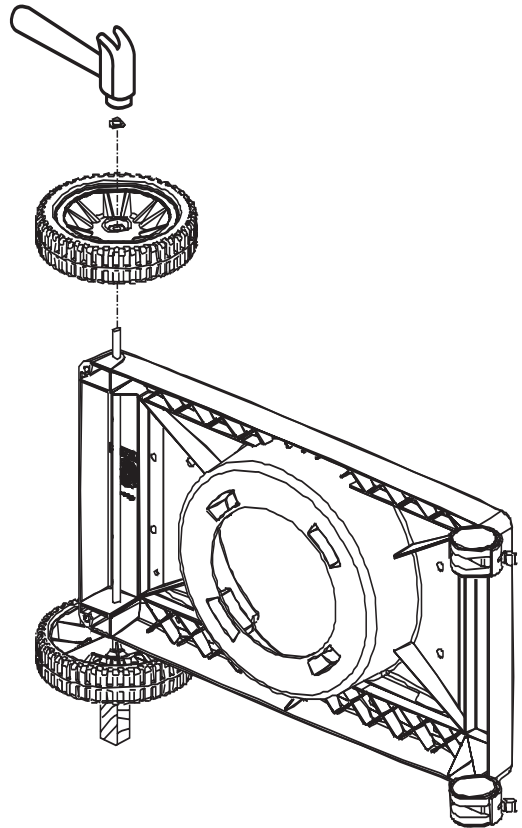
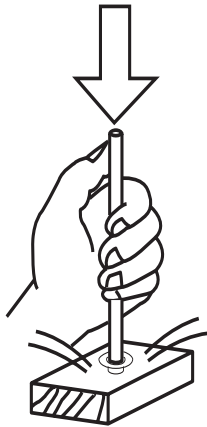
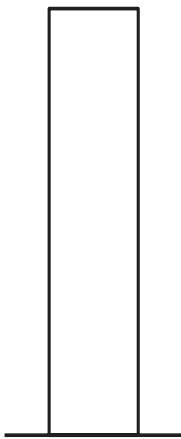
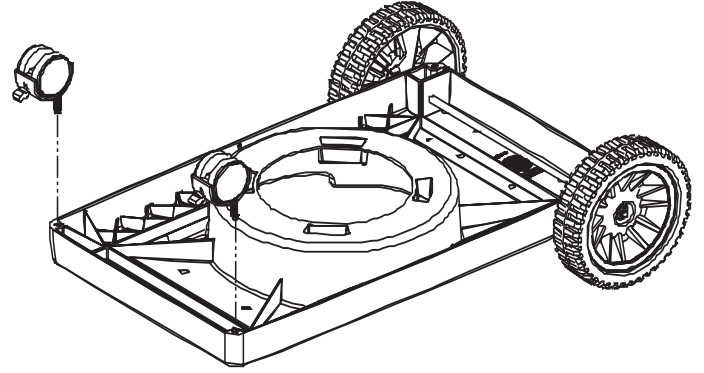
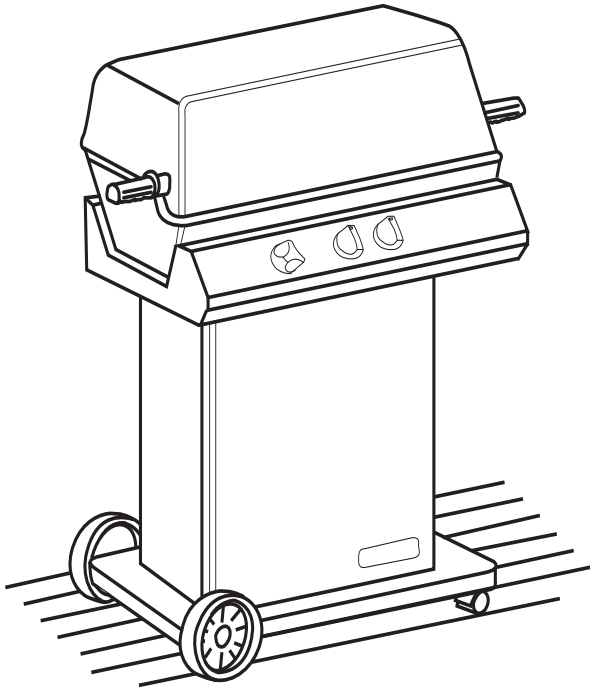

2

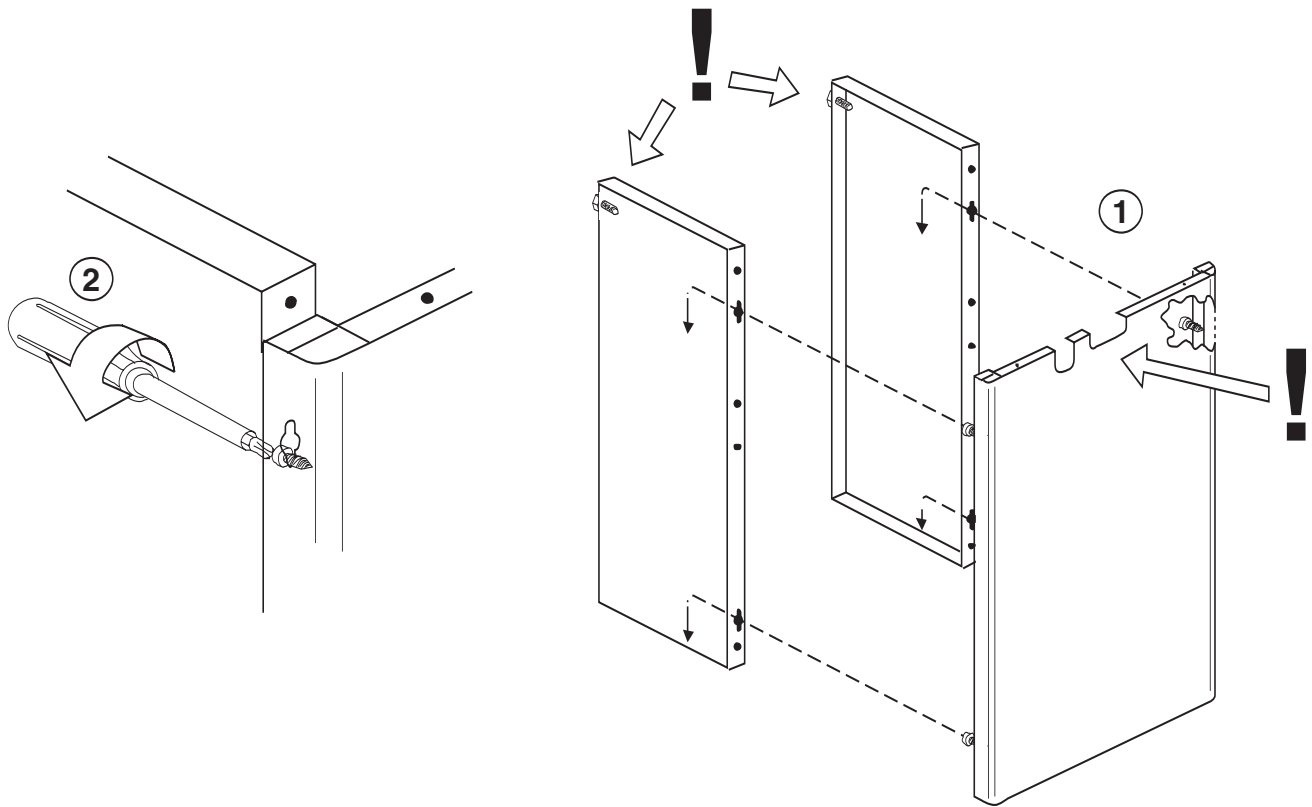

3

(6)

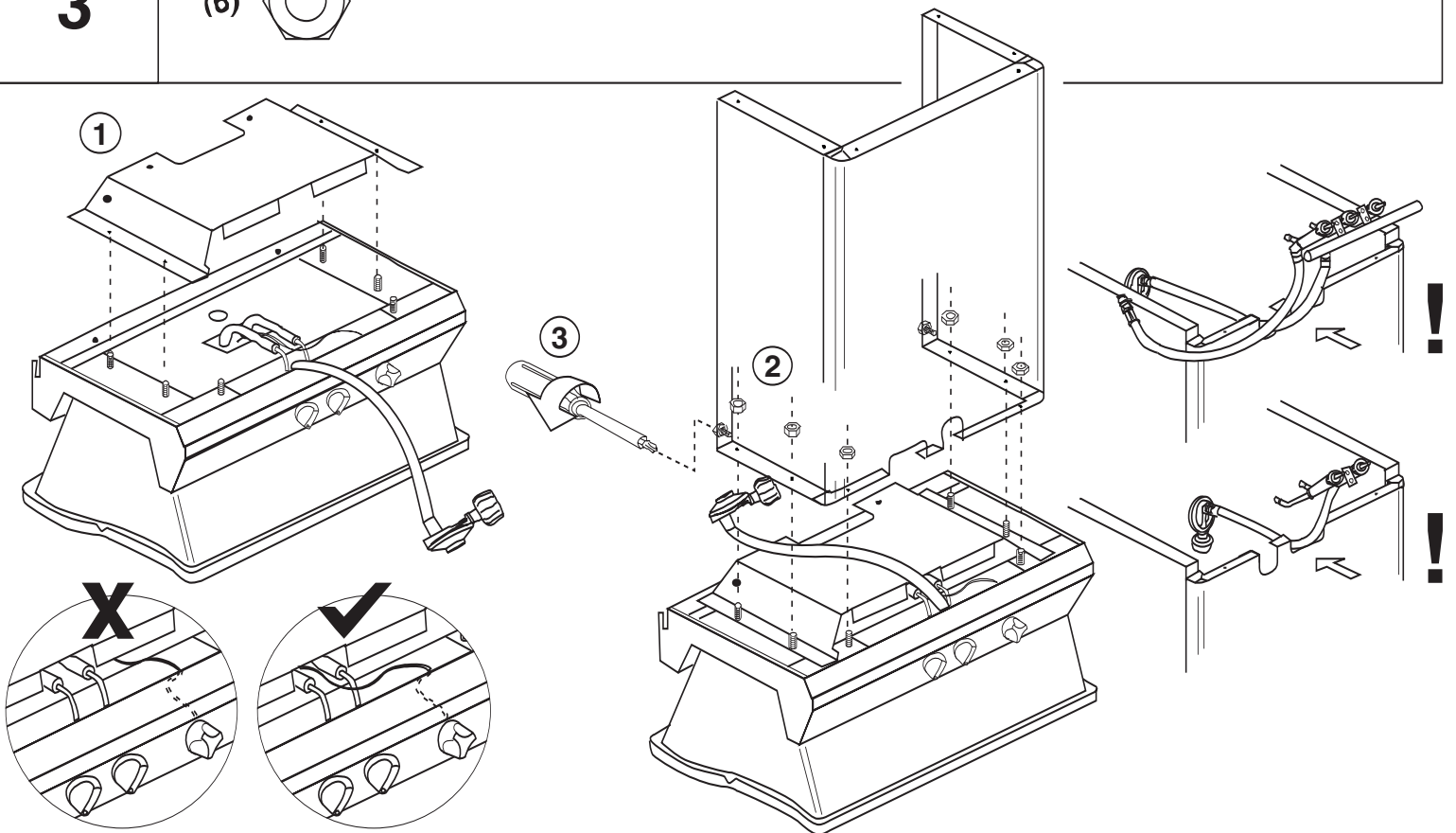

4

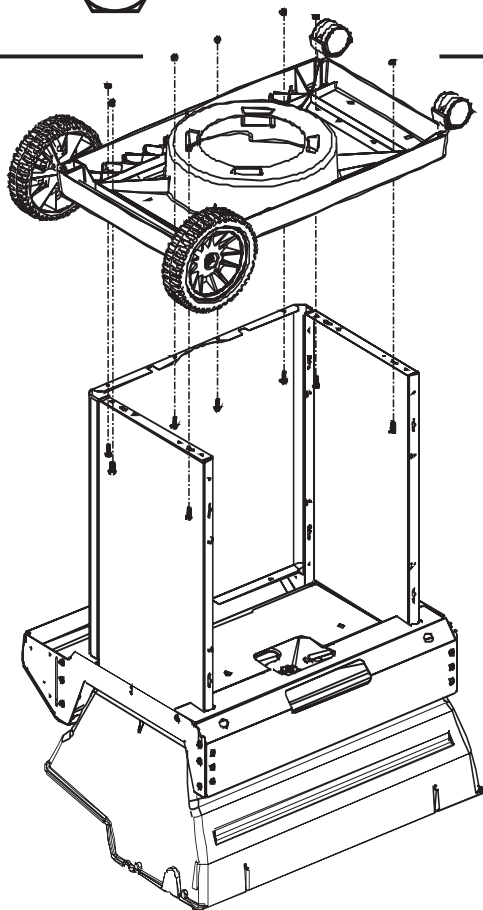

5

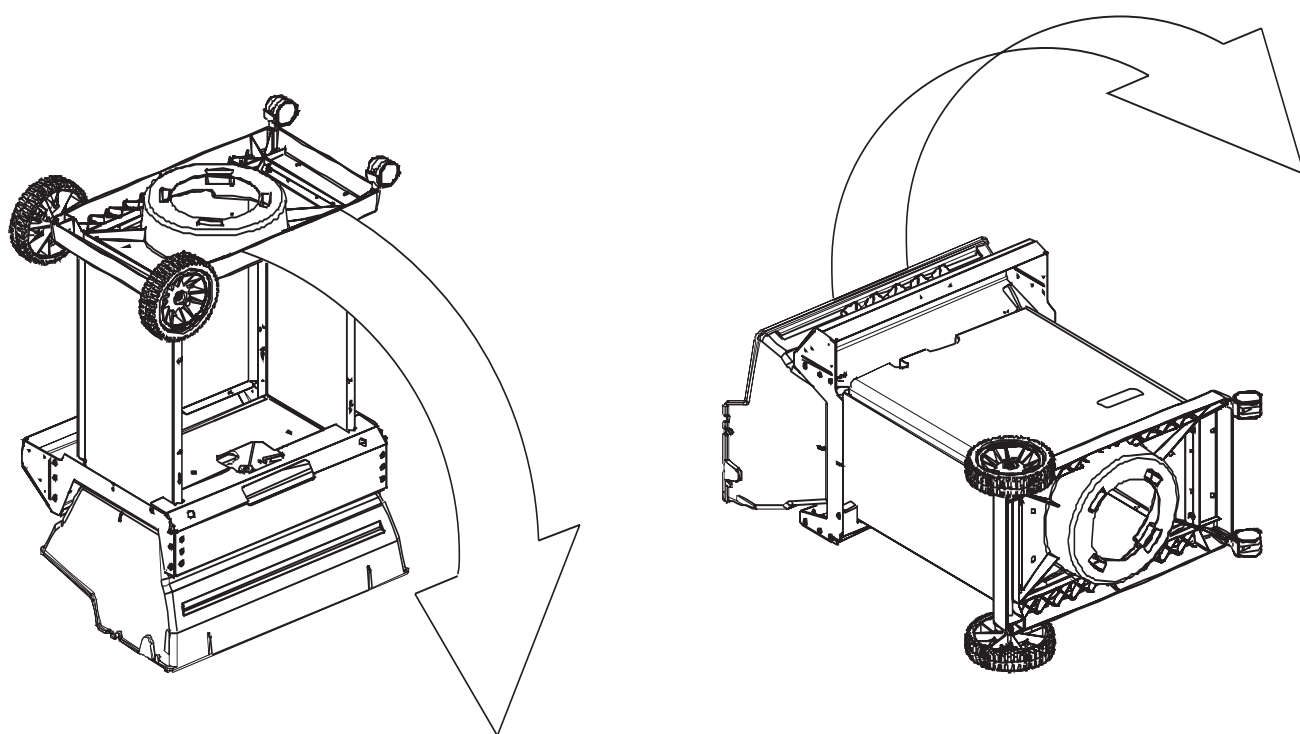

6

(2) 

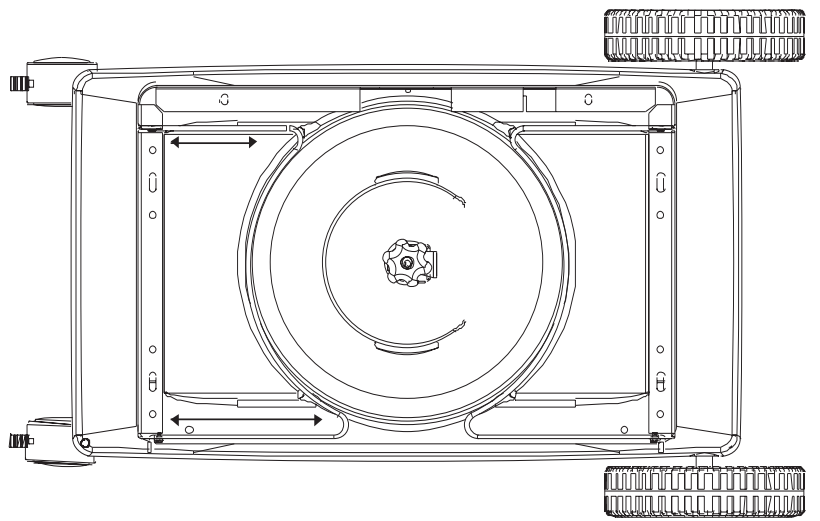
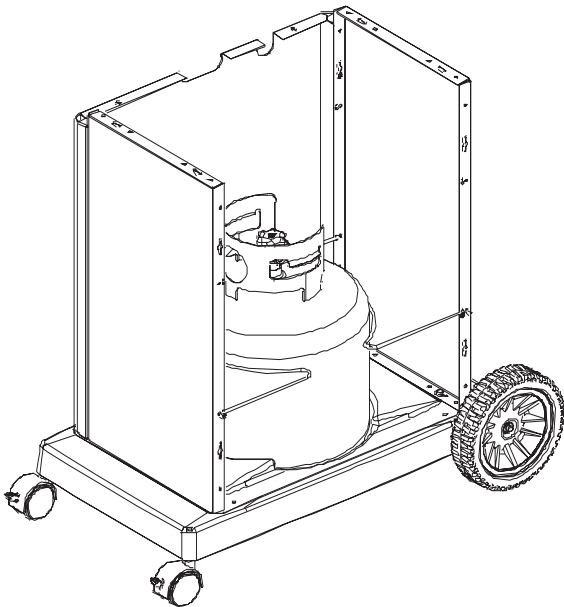
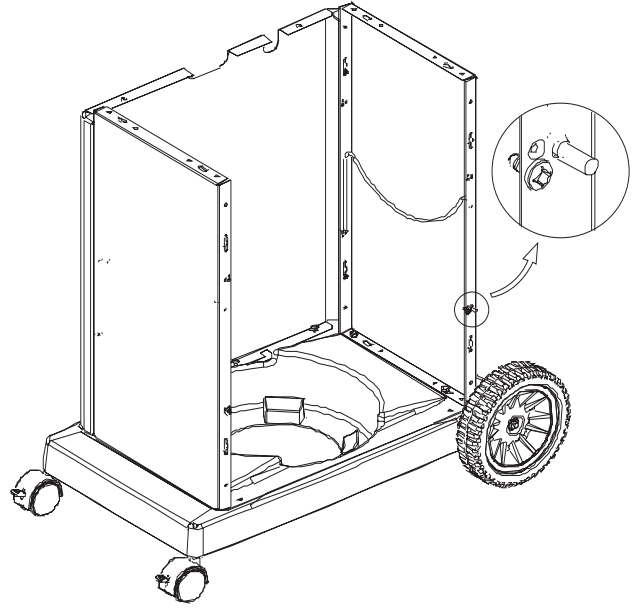
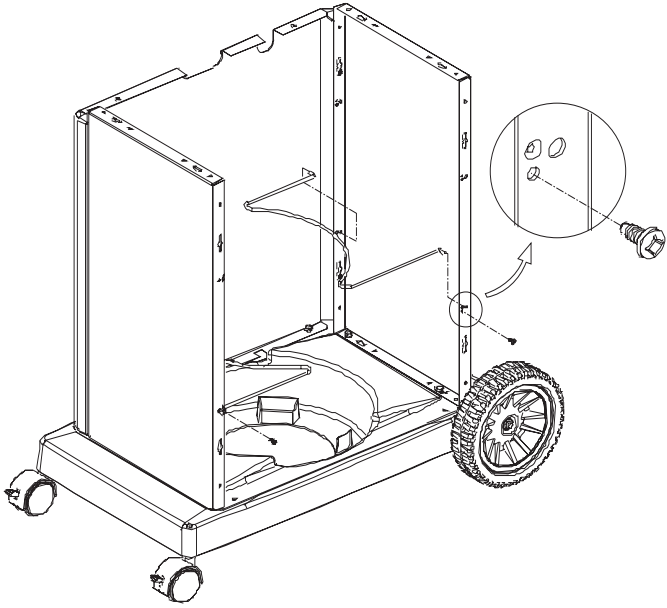

7

(2)



(2)

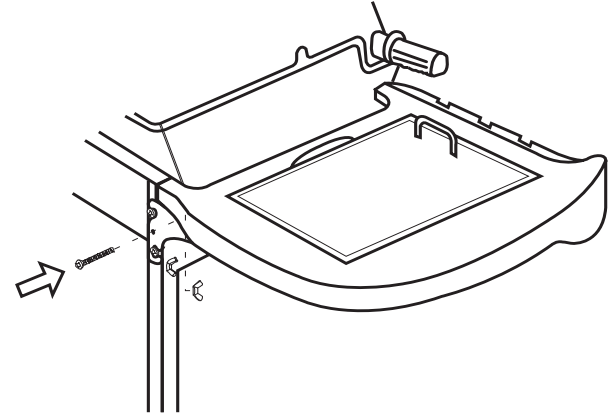
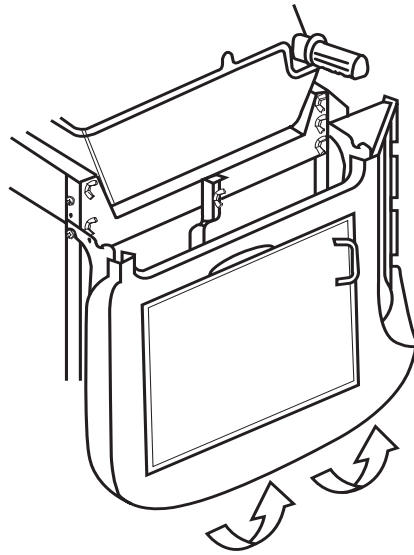
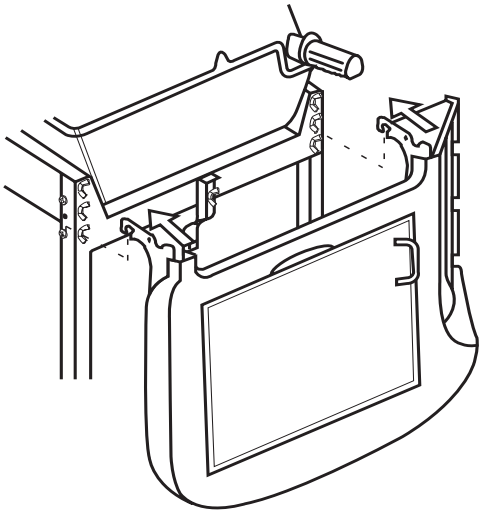
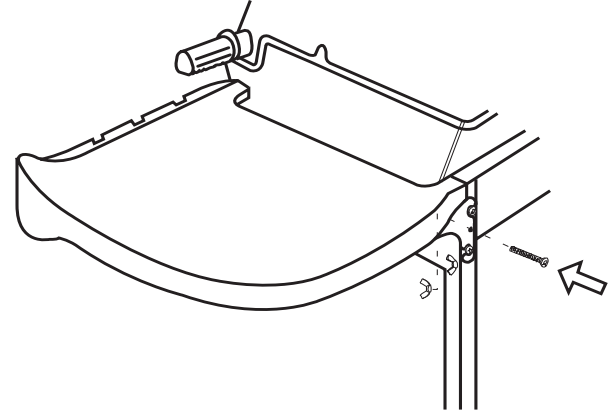
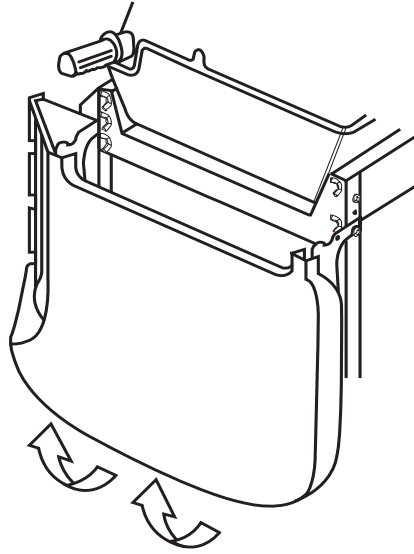
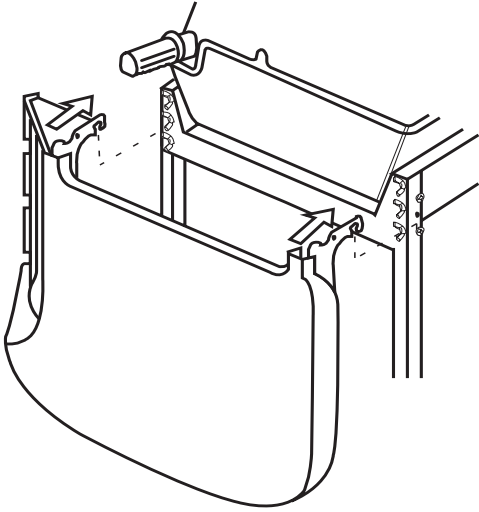

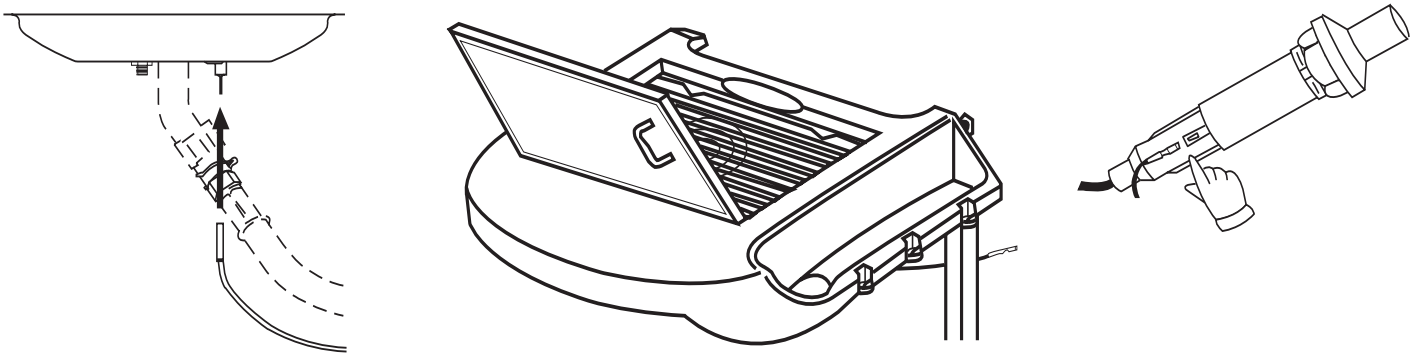
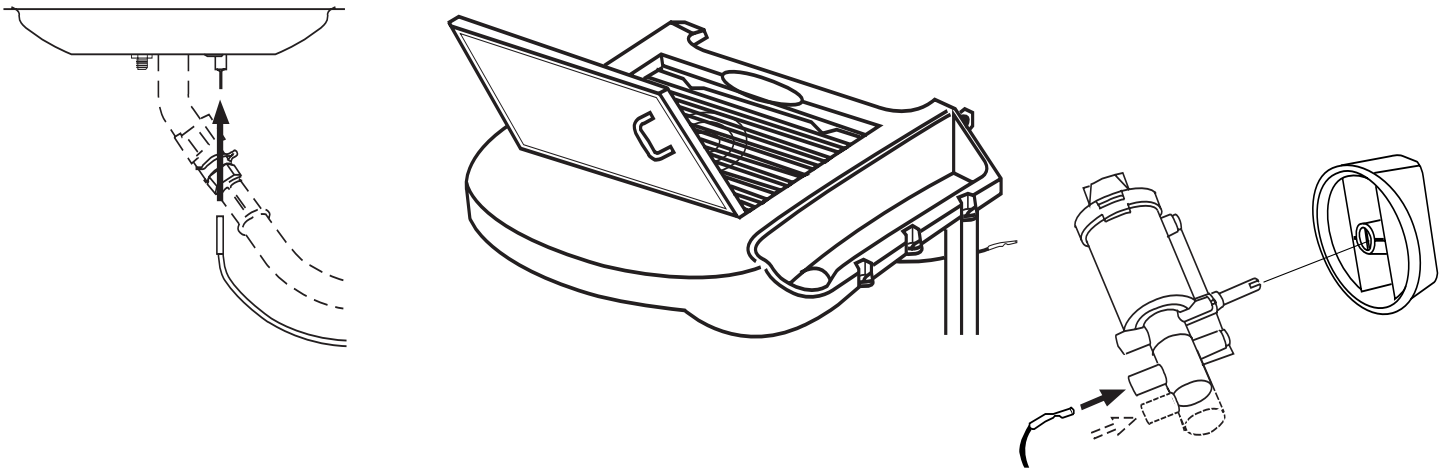
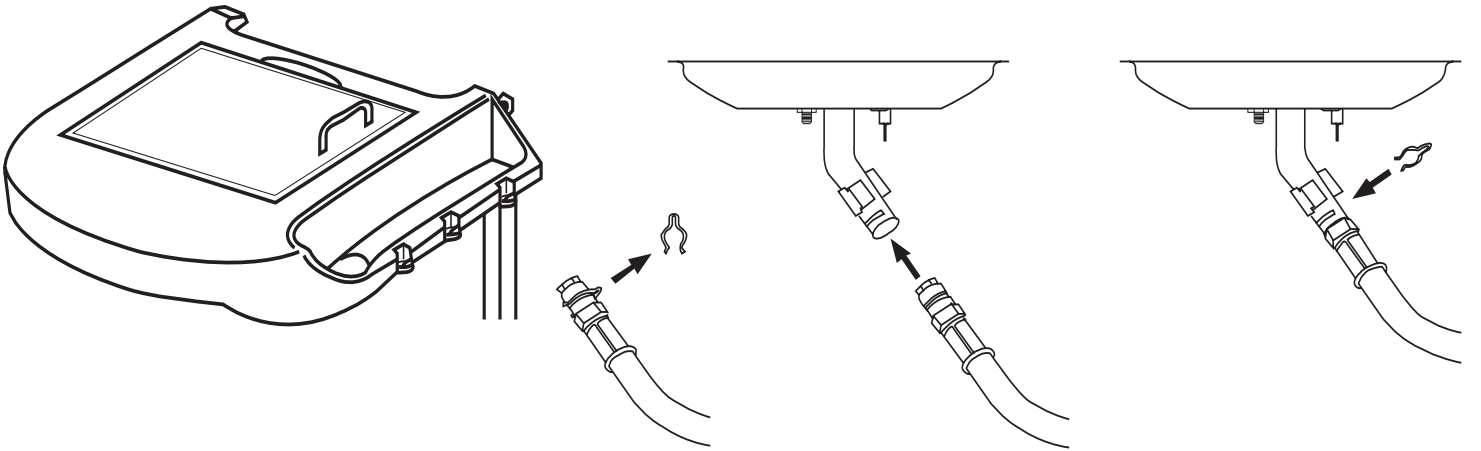

8

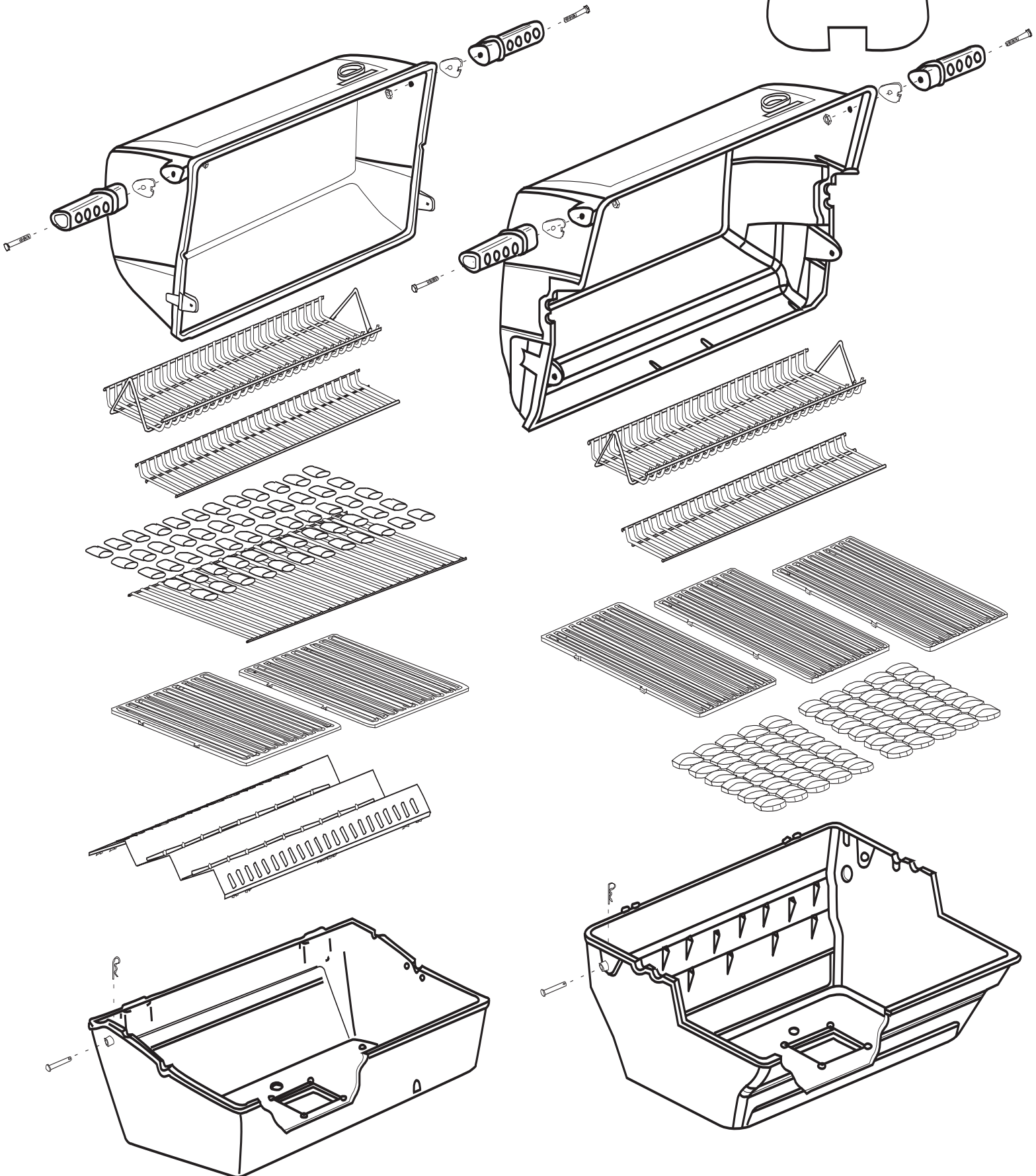
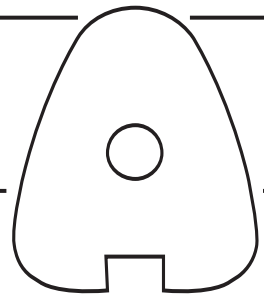

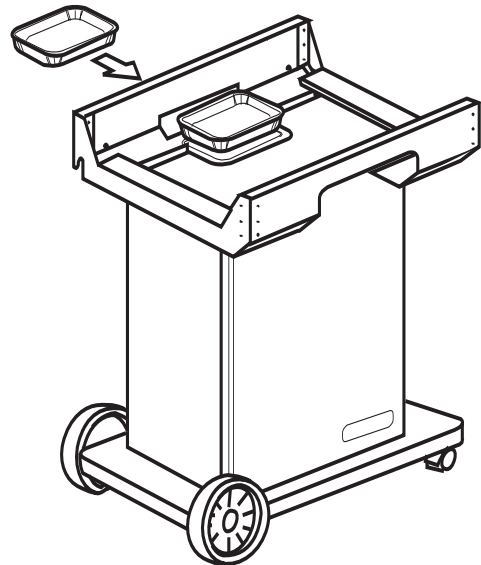
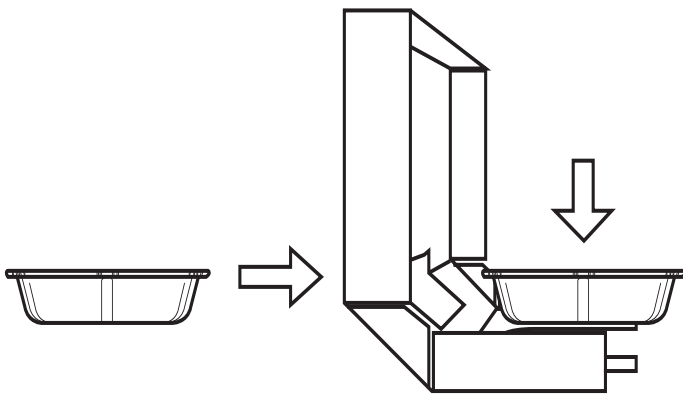
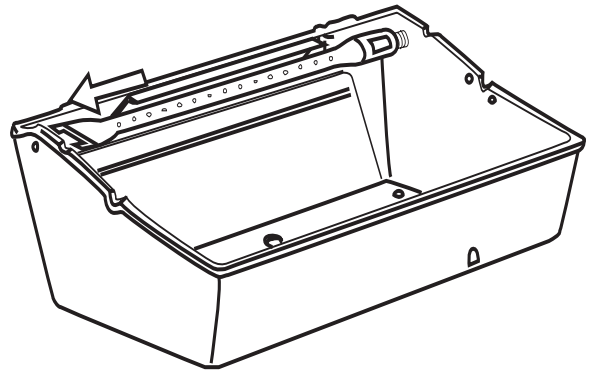
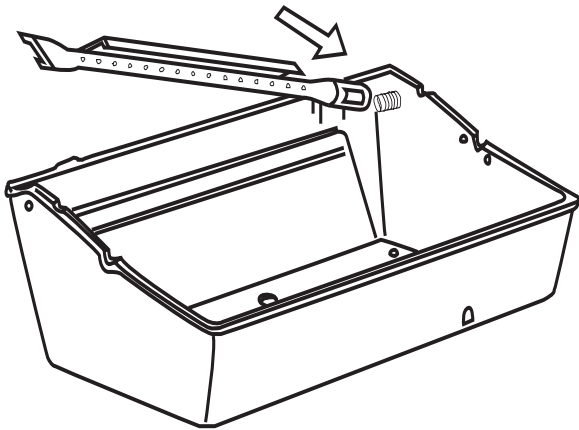
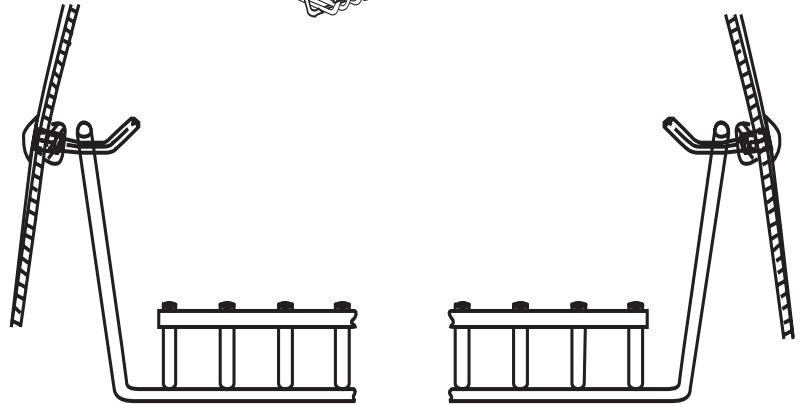
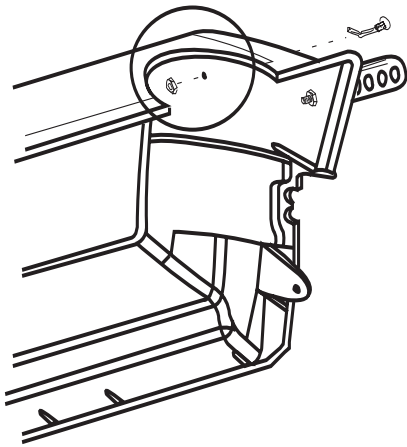
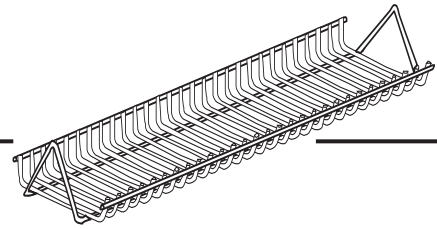
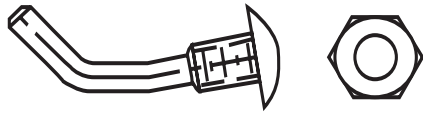

PARTS LIST/LISTE DES PIECES

KEY #	ITEM #	DESCRIPTION	DESCRIPTION	958-74	958-94	969-24	969-44	969-74	969-94	5818-4	5848-4
				958-77	958-97	969-27	969-47	969-77	969-97	5818-7	5848-7
1.	10909-T45	CASTING BOTTOM	FOND DU FOYER	1	1
	10909-T50	CASTING BOTTOM	FOND DU FOYER	1	1
	10909-T60	CASTING BOTTOM	FOND DU FOYER	.	.	1	1	1	1	.	.
2.	10473-T45	CASTING TOP	COUVERCLE DU GRIL	1	1
	10473-T50	CASTING TOP	COUVERCLE DU GRIL	1	1
	10473-T60	CASTING TOP	COUVERCLE DU GRIL	.	.	1	1	1	1	.	.
3.	10081-BK603	NAMEPLATE	PLAQUE D'IDENTIFICATION	1	1	1	1	1	1	1	1
3A.	10081-BK601	NAMEPLATE	PLAQUE D'IDENTIFICATION	1	1	1	1	1	1	1	1
4.	10958-K70	TOP CASTING INSERT	PANNEAU DE COUVERCLE	1	1	1	1	1	1	1	1
5.	10571-6	HEAT INDICATOR	INDICATEUR DE CHALEUR	1	1	1	1	1	1	1	1
6.	10240-15	HINGE PIN	ATTACHE DE CHEVILLE	2	2	2	2	2	2	2	2
6A.	S21237	HINGE PIN SPACER	ESPACEUR DE CHEVILLE CHARNIERES	2	2	2	2	2	2	2	2
7.	S21233	HITCH PIN CLIP	ATTACHE DE CHEVILLE	2	2	2	2	2	2	2	2
9.	10225-T429	GRID - PORCELAIN	GRILLE	2	2
	10225-T536	GRID - PORCELAIN	GRILLE	3	3
	10225-T626	GRID - PORCELAIN	GRILLE	.	.	3	3	3	3	.	.
10.	10222-T425	FLAV-R-WAVE SS	FLAV-R-WAVE SS	1	1	1	1
	10222-T626	FLAV-R-CAST	FLAV-R-CAST	.	.	2	2	2	2	.	.
11.	10225-T451	GRID - WARMING RACK	GRILLE	1	1
	10225-T528	GRID - WARMING RACK	GRILLE	1	1
	10225-T628	GRID - WARMING RACK	GRILLE	.	.	1	1	1	1	.	.
12.	10225-T627	SWING BASKET	PANIER À BALANCOIR	.	.	1	1	1	1	1	1
13.	Y-11797	BOLT SWING BASKET	BOULON POUR PANIER A BALANCOIR	.	.	2	2	2	2	2	2
15.	10390-T501	BURNER/VENTURI ASSY	ENSEMBLE DE BRULEUR	1	1	1	1	1	1	.	.
	S10017	BURNER/VENTURI ASSY	ENSEMBLE DE BRULEUR	1	1
17.	10342-242	ROTARY IGNITOR	ALLUMEUR ROTATIF	1	.	1	.	1	.	1	.
	10342-243	ROTARY IGNITOR	ALLUMEUR ROTATIF	.	1	.	1	.	1	.	1
	10472-K40	ROTARY IGNITOR KNOB	BOUTON ROTATOIRE D'IGNITOR	1	1	1	1	1	1	1	1
18.	10342-T301	ELECTRODE	ELECTRODE	2	2	2	2	2	2	.	.
	S15500	ELECTRODE	ELECTRODE	2	2
21.	10440-R70	CONTROL ASSY LP-3V	SOUPAPE, (GAZ PROPANE)	1
	10440-R71	CONTROL ASSY NG-3V	SOUPAPE, (GAZ NATUREL)	1
	10442-R58	CONTROL ASSY LP-4V	SOUPAPE, (GAZ PROPANE)	.	1
	10442-R59	CONTROL ASSY NG-4V	SOUPAPE, (GAZ NATUREL)	.	1
	10440-D60	CONTROL ASSY LP-2V	SOUPAPE, (GAZ PROPANE)	.	.	1
	10440-D61	CONTROL ASSY NG-2V	SOUPAPE, (GAZ NATUREL)	.	.	1
	10442-D62	CONTROL ASSY LP-3V	SOUPAPE, (GAZ PROPANE)	.	.	.	1
	10442-D63	CONTROL ASSY NG-3V	SOUPAPE, (GAZ NATUREL)	.	.	.	1
	10440-R64	CONTROL ASSY LP-3V	SOUPAPE, (GAZ PROPANE)	1	.	.	.
	10440-R65	CONTROL ASSY NG-3V	SOUPAPE, (GAZ NATUREL)	1	.	.	.
	10442-R66	CONTROL ASSY LP-4V	SOUPAPE, (GAZ PROPANE)	1	.	.
	10442-R67	CONTROL ASSY NG-4V	SOUPAPE, (GAZ NATUREL)	1	.	.
	10440-D80	CONTROL ASSY LP-2V	SOUPAPE, (GAZ PROPANE)	1	.
	10440-D81	CONTROL ASSY NG-2V	SOUPAPE, (GAZ NATUREL)	1	.
	10442-R86	CONTROL ASSY LP-4V	SOUPAPE, (GAZ PROPANE)	1
	10442-R87	CONTROL ASSY NG-4V	SOUPAPE, (GAZ NATUREL)	1
21A.	S13467-091	HOSE-SIDE BURNER LP	TUYAU DU BRULEUR LATERAL PL	.	1	.	1	.	1	.	1
	S13467-132	HOSE-SIDE BURNER NG	TUYAU DU BRULEUR LATERAL GN	.	1	.	1	.	1	.	1
	Y-11230	COTTER PIN	ATTACHE DE CHEVILLE	.	1	.	1	.	1	.	1
21B.	10110-91	TUBE-REAR BURNER ASSY	TUBE DE BRULEUR ARRIERE	1	1	.	.	1	1	.	1
22.	10114-17	HOSE & REGULATOR LP - QCC1	TUYAU ET REGULATEUR PL - QCC1	1	1	1	1	1	1	1	1
	10111-K47	HOSE NATURAL GAS	TUYAU (GAZ NATUREL)	1	1	1	1	1	1	1	1
23.	10472-K37	CONTROL KNOB	BOUTON DE CONTROLE	3	4	2	3	3	4	2	4
30.	10086-D561	DECO PLATE-3V	PLAQUE DECORATIVE	1
	10086-D571	DECO PLATE-4V	PLAQUE DECORATIVE	.	1
	10086-R541	DECO PLATE-2V	PLAQUE DECORATIVE	1	.
	10086-R571	DECO PLATE-4V	PLAQUE DECORATIVE	1
30A.	10086-D54	DECO PLATE-REGAL	PLAQUE DECORATIVE	1	1
	10086-R63	DECO PLATE -SIGNET	PLAQUE DECORATIVE	1	1
	10081-BK613	NAMEPLATE	PLAQUE D'IDENTIFICATION	.	.	1	1	1	1	.	.

