

This Owner's Manual is provided and hosted by [Appliance Factory Parts](#).



# Kenmore 721.80022700 Owner's Manual

[Shop genuine replacement parts for Kenmore  
721.80022700](#)

FOR MODEL: 721.80022700  
721.80029700

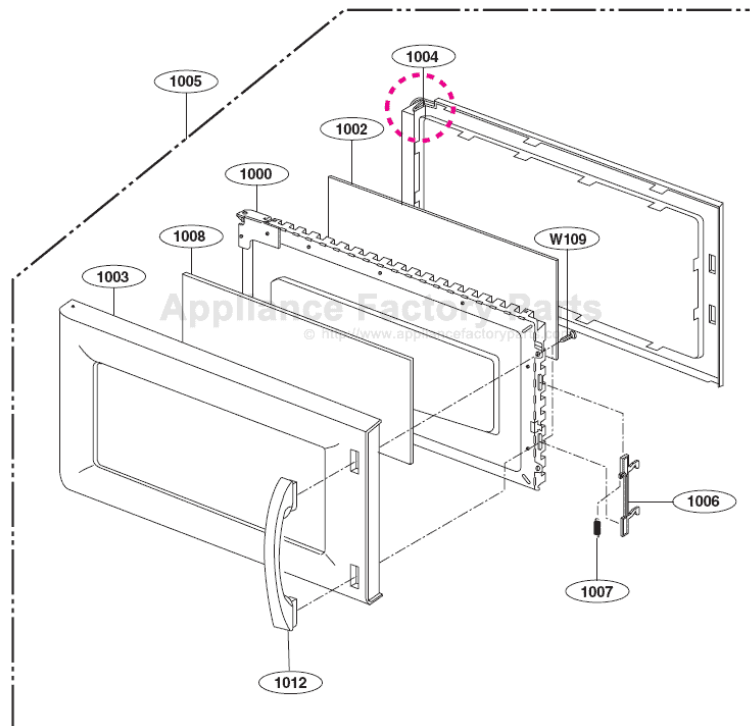

[Find Your Kenmore Microwave Parts - Select From 532 Models](#)

----- Manual continues below -----

# Galaxy<sup>®</sup>

Microwave Hood Combination

Use & Care Guide

Combinación Microondas Campana

Guía de uso y cuidado

Models/Modelos 721.80022

721.80029

ENGLISH

ESPAÑOL

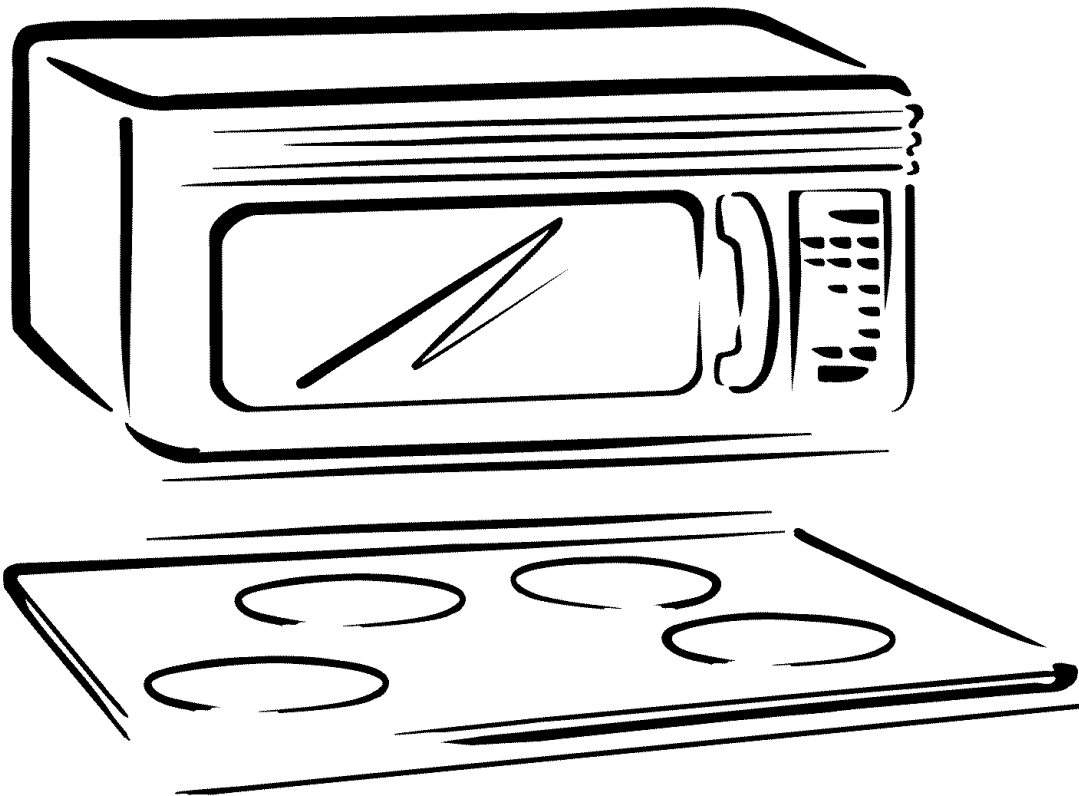

# Table of Contents

Warranty .....	2
Sears Service.....	3
Microwave Oven Safety .....	4
Getting to Know Your Microwave Oven .....	7
How your microwave oven works .....	7
Radio interference .....	7
For the best cooking results .....	7
Cookware guide .....	8
Operating safety precautions .....	8
Electrical connection .....	8
Specifications .....	9
Microwave oven features .....	9
Control panel features.....	10
Using Your Microwave Oven .....	12
Audible Signals .....	12
Interrupting Cooking.....	12
Clock .....	12
Child Lock .....	12
Turntable On/Off.....	13
Cooktop Light.....	13
Time Defrost .....	13
Exhaust Fan.....	13
Timed Cooking.....	14
Multi-stage Cooking .....	14
Microwave Power Levels .....	15
Auto Defrost .....	16
Operating Tips .....	16
Auto defrost table.....	17
Auto defrost table (Cont.).....	18
Defrosting tips .....	19
Using Quick Touch.....	20
Auto Cook .....	21
Cooking guide for Auto Cook .....	21
Auto Reheat .....	22
Cooking guide for Auto Reheat.....	22
Caring for Your Microwave Oven .....	23
Caring for the filters.....	24
Replacing the cooktop and oven lights .....	25
Microwave Cooking Tips.....	26~27
Questions and Answers .....	28
Troubleshooting.....	29~30
Service .....	Back cover

# Microwave Hood Combination Warranty

## One Year Limited Warranty

When installed, operated and maintained according to all instructions supplied with the product, if this appliance fails due to a defect in material or workmanship within one year from the date of purchase, call 1-800-4-MY-HOME® to arrange for free repair.

### This warranty covers only defects in material and workmanship. Sears will NOT pay for:

1. Expendable items that can wear out from normal use, including but not limited to filters, belts, light bulbs, and bags.
2. A service technician to instruct the user in correct product installation, operation or maintenance.
3. A service technician to clean or maintain this product.
4. Damage to or failure of this product if it is not installed, operated or maintained according to all instructions supplied with the product.
5. Damage to or failure of this product resulting from accident, abuse, misuse or use for other than its intended purpose.
6. Damage to or failure of this product caused by the use of detergents, cleaners, chemicals or utensils other than those recommended in all instructions supplied with the product.
7. Damage to or failure of parts or systems resulting from unauthorized modifications made to this product.

### Disclaimer of implied warranties; limitation of remedies

Customer's sole and exclusive remedy under this limited warranty shall be product repair as provided herein. Implied warranties, including warranties of merchantability or fitness for a particular purpose, are limited to one year or the shortest period allowed by law. Sears shall not be liable for incidental or consequential damages. Some states and provinces do not allow the exclusion or limitation of incidental or consequential damages, or limitations on the duration of implied warranties of merchantability or fitness, so these exclusions or limitations may not apply to you.

This warranty applies only while this appliance is used in the United States and Canada.

This warranty gives you specific legal rights, and you may also have other rights which vary from state to state.

Sears, Roebuck and Co., Dept. 817WA, Hoffman Estates, IL 60179  
Sears Canada Inc., Toronto, Ontario, Canada M5B 2B8

# Sears Service

## Master Protection Agreement

*Congratulations on making a smart purchase.*

Your new Kenmore® product is designed and manufactured for years of dependable operation. But like all products, it may require preventive maintenance or repair from time to time.

The Master Protection Agreement also helps extend the life of your new product. Here's what the Agreement\* includes:

- ✓ **Parts and labor** needed to help keep products operating properly **under normal use**, not just defects. Our coverage goes **well beyond the product warranty**. No deductibles, no functional failure excluded from coverage - **real protection**.
- ✓ **Expert service** by a force of more than **10,000 authorized Sears service technicians**, which means someone you can trust will be working on your product.
- ✓ **Unlimited service calls and nationwide service**, as often as you want us, whenever you want us.
- ✓ **"No-lemon" guarantee** - replacement of your covered product if four or more product failures occur within twelve months.
- ✓ **Product replacement** if your covered product can't be fixed.
- ✓ **Annual Preventive Maintenance Check** at your request - no extra charge.
- ✓ **Fast help by phone** - we call it **Rapid Resolution** - phone support from a Sears representative on all products. Think of us as a "talking owner's manual."
- ✓ **Power surge protection** against electrical damage due to power fluctuations.
- ✓ **\$250 Food Loss Protection** annually for any food spoilage that is the result of mechanical failure of any covered refrigerator or freezer.
- ✓ **Rental reimbursement** if repair of your covered product takes longer than promised.
- ✓ **10% discount** off the regular price of any non-covered repair service and related installed parts.

Once you purchase the Agreement, a simple phone call is all that it takes for you to schedule service. You can call anytime day or night, or schedule a service appointment online

The Master Protection Agreement is a risk free purchase. If you can-cel for any reason during the product warranty period, we will provide a full refund. Or, a prorated refund anytime after the product warranty period expires.

Purchase your Master Protection Agreement today!

**Some limitations and exclusions apply. For prices and additional information in the U.S.A. call 1-800-827-6655.**

**\* Coverage in Canada varies on some items. For full details call Sears Canada at 1-800-361-6665.**

### Sears Installation Service

**For Sears professional installation** of home appliances, garage door openers, water heaters, and other major home items, in the U.S.A. or Canada call **1-800-4-MY-HOME®**.

ENGLISH

# Microwave Oven Safety

## Your safety and the safety of others is very important.

We have provided many important safety messages in this manual and on your microwave oven. Always read and obey all safety messages.



This is the safety alert symbol.

This symbol alerts you to hazards that can kill or hurt you and others.

All safety messages will be preceded by the safety alert symbol and the word "DANGER" or "WARNING." These words mean:

 **DANGER**

You will be killed or seriously injured if you don't follow instructions immediately.

 **WARNING**

You can be killed or seriously injured if you don't follow instructions.

All safety messages will identify the hazard, tell you how to reduce the chance of injury, and tell you what can happen if the instructions are not followed.

## IMPORTANT SAFETY INSTRUCTIONS

When using electrical appliances, basic safety precautions should be followed, including the following:

**⚠️ WARNING:** To reduce the risk of burns, electric shock, fire, injury to persons, or exposure to excessive microwave energy:

- Read all instructions before using the microwave oven.
- Read and follow the specific "PRECAUTIONS TO AVOID POSSIBLE EXPOSURE TO EXCESSIVE MICROWAVE ENERGY" found on page 6.
- The microwave oven must be grounded. Connect only to properly grounded outlet. See "GROUNDING INSTRUCTIONS" found on page 4,5 and 6.
- Install or locate the microwave oven only in accordance with the provided installation instructions.
- Some products such as whole eggs in the shell and sealed containers – for example, closed glass jars – are able to explode and should not be heated in the microwave oven.
- Use the microwave oven only for its intended use as described in this manual. Do not use corrosive chemicals or vapors in the microwave oven. This type of oven is specifically designed to heat, cook, or dry food. It is not designed for industrial or laboratory use.
- As with any appliance, close supervision is necessary when used by children.
- Do not operate the microwave oven if it has a damaged cord or plug, if it is not working properly, or if it has been damaged or dropped.

**SAVE THESE INSTRUCTIONS**

## IMPORTANT SAFETY INSTRUCTIONS

- The microwave oven should be serviced only by qualified service technician. Call an authorized service company for examination, repair, or adjustment.
- See door surface cleaning instructions in the “Caring for Your Microwave Oven” section.
- To reduce the risk of fire in the oven cavity:
  - Do not overcook food. Carefully attend the microwave oven when paper, plastic, or other combustible materials are placed inside the oven to facilitate cooking.
  - Remove wire twist-ties from paper or plastic bags before placing bags in oven.
  - If materials inside the oven ignite, keep oven door closed, turn oven off, and disconnect the power cord, or shut off power at the fuse or circuit breaker panel.
  - Do not use the cavity for storage purposes. Do not leave paper products, cooking utensils, or food in the cavity when not in use.
- Suitable for use above both gas and electric cooking equipment.
- Intended to be used above ranges with maximum width of 36 inches (91 cm).
- Clean Ventilating Hoods Frequently -Grease should not be allowed to accumulate on hood or filter.
- When flaming foods under the hood, turn the fan on.
- Use care when cleaning the vent-hood filter. Corrosive cleaning agents, such as lye-based oven cleaners, may damage the filter.
- Oversized foods or oversized metal utensils should not be inserted in the microwave oven as they may create a fire or risk of electric shock.
- Do not clean with metal scouring pads. Pieces can burn off the pad and touch electrical parts involving a risk of electric shock.
- Do not store anything directly on top of the microwave oven when the microwave oven is in operation.
- Do not cover or block any openings on the microwave oven.
- Do not store this microwave oven outdoors. Do not use the microwave oven near water - for example, near a kitchen sink, in a wet basement, near a swimming pool, or similar location.
- Do not immerse cord or plug in water.
- Keep cord away from heated surfaces.
- Do not let cord hang over edge of table or counter.
- Do not mount over a sink.
- Do not cover racks or any other part of the oven with metal foil. This will cause overheating of the oven.
- Liquids such as water, coffee, or tea are able to be overheated beyond the boiling point without appearing to be boiling due to surface tension of the liquid. Visible bubbling or boiling when the container is removed from the microwave oven is not always present. This could result in very hot liquids suddenly boiling over when a spoon or other utensil is inserted into the liquid. To reduce the risk of injury to persons;
  - 1) Do not overheat the liquid.
  - 2) Stir the liquid both before and halfway through heating it.
  - 3) Do not use straight-sided containers with narrow necks.
  - 4) After heating, allow the container to stand in the microwave oven for a short time before removing the container.
  - 5) Use extreme care when inserting utensils into the container.

**SAVE THESE INSTRUCTIONS**

**ENGLISH**

## PRECAUTIONS TO AVOID POSSIBLE EXPOSURE TO EXCESSIVE MICROWAVE ENERGY

- (a) Do not attempt to operate this oven with the door open since open-door operation can result in harmful exposure to microwave energy. It is important not to defeat or tamper with the safety interlocks.
- (b) Do not place any object between the oven front face and the door, or allow soil or cleaner residue to accumulate on sealing surfaces.
- (c) Do not operate the oven if it is damaged. It is particularly important that the oven door close properly and that there is no damage to the:
  - (1) Door (bent).
  - (2) Hinges and latches (broken or loosened).
  - (3) Door seals and sealing surfaces.
- (d) The oven should not be adjusted or repaired by anyone except properly qualified service technician.

## Electrical requirements

Observe all governing codes and ordinances. A 120-Volt, 60-Hz, AC-only, 15- or 20-amp fused electrical supply is required. (A time-delay fuse is recommended.) It is recommended that a separate circuit serving only this appliance be provided.

**! DANGER**



**Electrical Shock Hazard**  
 Plug into a grounded 3 prong outlet. Do not remove ground prong. Do not use an adapter. Do not use an extension cord. Failure to follow these instructions can result in death, fire, or electrical shock.

## GROUNDING INSTRUCTIONS

• **For all cord connected appliances:**  
 The microwave oven must be grounded. In the event of an electrical short circuit, grounding reduces the risk of electric shock by providing an escape wire for the electric current. The microwave oven is equipped with a cord having a grounding wire with a grounding plug. The plug must be plugged into an outlet that is properly installed and grounded.

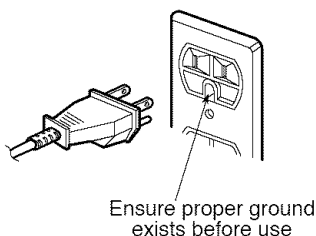

**! WARNING:** Improper grounding can result in a risk of electric shock. Consult a qualified electrician or service technician if you do not understand the grounding instructions or if you wonder whether the appliance is properly grounded. Do not use an extension cord. If the power supply cord is too short, have a qualified electrician or service technician install an outlet near the microwave oven.

• **For a permanently connected appliance:**  
 This appliance has a short power supply cord to reduce the risk of anyone tripping over or becoming entangled in the cord. The microwave oven must be connected to a grounded, metallic, permanent wiring system, or an equipment grounding conductor should be run with the circuit conductors and connected to the equipment grounding terminal or lead on the microwave oven.

**SAVE THESE INSTRUCTIONS**

# Getting to Know Your Microwave Oven

This section discusses the concepts behind microwave cooking. It also shows you the basics you need to know to operate your microwave oven. Please read this information before you use your oven.

## How your microwave oven works

**Microwave ovens are safe.** Microwave energy is not hot. It causes food to make its own heat, and it's this heat that cooks the food.

Microwaves are like TV waves, radio waves, or light waves. You cannot see them, but you can see what they do.

**A magnetron** in the microwave oven produces microwaves. The microwaves move into the oven where they contact food as it turns on the turntable.

**The glass turntable** of your microwave oven lets microwaves pass through. Then they bounce off a metal floor, back through the glass turntable, and are absorbed by the food.

**Microwaves** pass through most glass, paper, and plastics without heating them so food absorbs the energy. Microwaves bounce off metal containers so food does not absorb the energy.

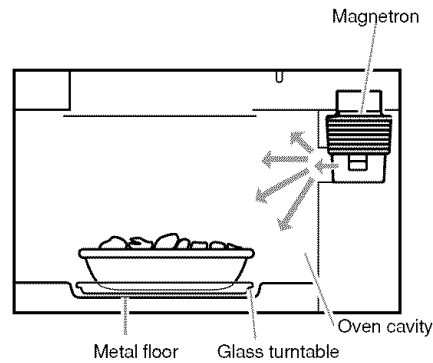

ENGLISH

## Radio interference

Using your microwave oven may cause interference to your radio, TV, or similar equipment. When there is interference, you can reduce it or remove it by:

- **Cleaning** the door and sealing surfaces of the oven.
- **Adjusting** the receiving antenna of the radio or television.
- **Moving** the receiver away from the microwave oven.
- **Plugging** the microwave oven into a different outlet so that the microwave oven and receiver are on different branch circuits.

## For the best cooking results

- **Always cook food** for the shortest cooking time recommended. Check to see how the food is cooking. If needed, touch Add Minute while the oven is operating or after the cooking cycle is over (see the "Using add minute" section).
- **Stir, turn over, or rearrange** the food being cooked about halfway through the cooking time for all recipes. This will help make sure the food is evenly cooked.
- **If you do not have a cover for a dish**, use wax paper, or microwave-approved paper towels or plastic wrap. Remember to turn back a corner of the plastic wrap to vent steam during cooking.



## Cookware guide

**Most heat resistant, nonmetallic cookware is safe for use in your microwave oven. However, to test cookware before using, follow these steps:**

1. Place the empty cookware in the microwave oven.
2. Measure 1 cup (250ml) water in a glass measuring cup and place it in the oven beside the cookware.
3. Microwave on 100% power for 1 minute. If the dish is warm, it should not be used for microwave cooking.

## Operating safety precautions

- **Never** lean on the door or allow a child to swing on it when the door is open.
- **Use hot pads.** Microwave energy does not heat containers, but the heat from the food can make the container hot.
- **Do not** use newspaper or other printed paper in the oven.
- **Do not** dry flowers, fruit, herbs, wood, paper, gourds, or clothes in the oven.
- **Do not** start a microwave oven when it is empty. Product life may be shortened. If you practice programming the oven, **put** a container of water in the oven. It is normal for the oven door to look wavy after the oven has been running for a while.
- **Do not** try to melt paraffin wax in the oven. Paraffin wax will not melt in a microwave oven because it allows microwaves to pass through it.
- **Do not** operate the microwave oven unless the glass turntable is securely in place and can rotate freely. The turntable can rotate in either direction. **Make sure** the turntable is correct-side up in the oven. **Handle your turntable with care** when removing it from the oven to avoid possibly breaking it. If your turntable cracks or breaks, contact your dealer for a replacement.
- **When you use a browning dish**, the browning dish bottom must be at least 3/16 inch above the turntable. Follow the directions supplied with the browning dish.
- **Never cook or reheat a whole egg inside the shell.** Steam buildup in whole eggs may cause them to burst, and possibly damage the oven. **Slice** hard-boiled eggs before heating. In rare cases, poached eggs have been known to explode. **Cover** poached eggs and **allow** a standing time of one minute before cutting into them.
- **For best results, stir any liquid several times during heating or reheating.** Liquids heated in certain containers (especially containers shaped like cylinders) may become overheated. The liquid may splash out with a loud noise during or after heating or when adding ingredients (coffee granules, tea bags, etc.). This can harm the oven.
- **Microwaves** may not reach the center of a roast. The heat spreads to the center from the outer, cooked areas just as in regular oven cooking. This is one of the reasons for letting some foods (for example, roasts or baked potatoes) stand for a while after cooking, or for stirring some foods during the cooking time.
- **Do not deep fry in the oven.** Microwavable utensils are not suitable and it is difficult to maintain appropriate deep-frying temperatures.
- **Do not overcook potatoes.** At the end of the recommended cooking time, potatoes should be slightly firm because they will continue cooking during standing time. **After microwaving, let** potatoes stand for 5 minutes. They will finish cooking while standing.

## Electrical connection

**If your electric power line or outlet voltage** is less than 110 volts, cooking times may be longer. Have a qualified electrician check your electrical system.

## Specifications

Power Supply	120V AC, 60 Hz
Rated Power Consumption	1500W
Microwave Output	*1000W
Rated Current	14.0A
Overall Dimensions(WxHxD)	29 15/16" x 16 7/16" x 15 3/8"
Oven Cavity Dimensions(WxHxD)	21 9/16" x 9 1/10" x 14 1/8"
Capacity of Oven Cavity	1.5 cu.ft

\*IEC 60705 RATING STANDARD

Specifications subject to change without prior notice.

## Microwave oven features

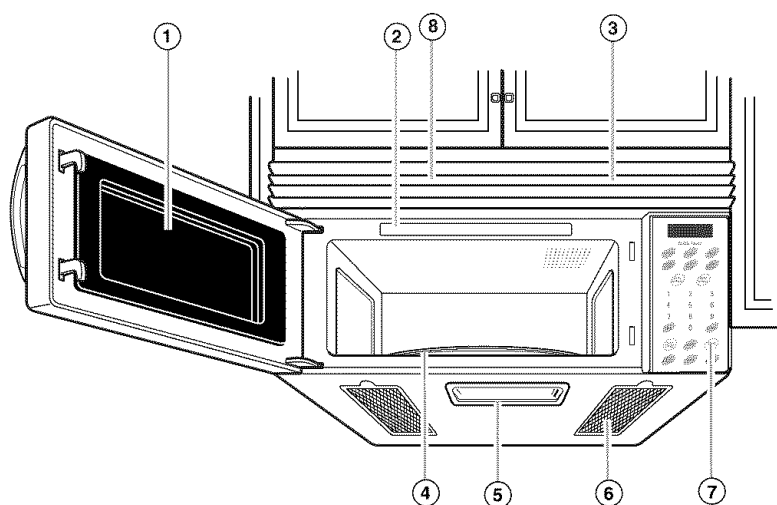

Your microwave oven is designed to make your cooking experience as enjoyable and productive as possible. To get you up and running quickly, the following is a list of the oven's basic features:

- 1. Metal Shielded Window** The shield prevents microwaves from escaping. It is designed as a screen to allow you to view food as it cooks.
- 2. Model and Serial Number Plate & Cooking Guide Label**

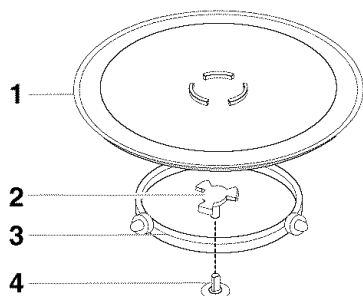

- 1. Turntable**
- 2. Hub**
- 3. Support**
- 4. Shaft**

### 3. Vent Grille

**4. Turntable.** The turntable turns food as it cooks for more even cooking. It must be in the oven during operation for best cooking results.

### 5. Cooktop Light

**6. Grease Filters.** See "Caring for the filters" section.

**7. Control Panel.** Touch the pads on this panel to perform all functions.

**8. Charcoal Filter** (behind Vent Grille)

The turntable rotates in both directions to help cook food more evenly. Do not operate the microwave oven without the turntable in place.

### To Install:

1. Place the support on the oven cavity bottom.
2. Place the turntable on the support.

Fit the raised, curved lines in the center of the turntable bottom between the three spokes of the hub.

The rollers on the support should fit inside the turntable bottom ridge.

## Control panel features

Your microwave oven control panel lets you select the desired cooking function quickly and easily. All you have to do is touch the necessary Command Pad. The following is a list of all the Command and Number Pads located on the control panel. **For more information on these features, see “Using your microwave oven” section.**

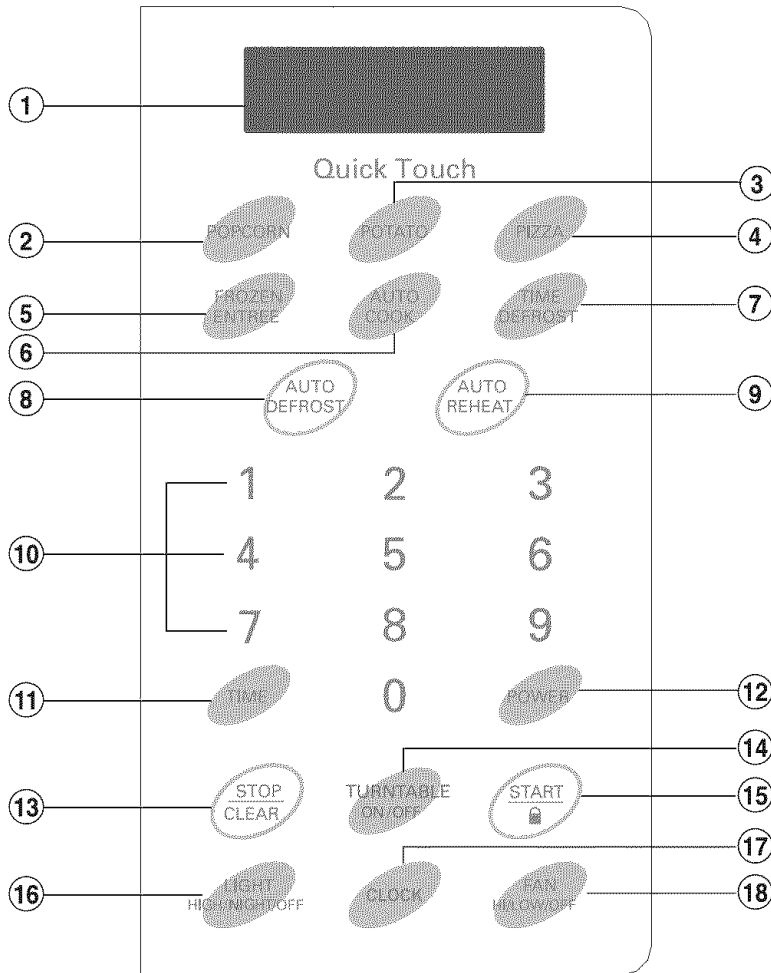

**1. Display.** The display includes a clock and indicators to tell you time of day, cooking time settings, cook powers, quantities, weights and cooking functions selected.

**2. POPCORN.** Touch this pad to pop one of 2 bag sizes of popcorn without entering a cook time or power.

3. **POTATO.** Touch this pad to cook up to 4 potatoes without entering a cook time or power.
  4. **PIZZA.** Touch this pad to reheat one or several slices of pizza without entering a cook time or power.
  5. **FROZEN ENTREE.** Touch this pad to cook a 10 - to 20 - ounce (284 to 567 g) frozen entree without entering a cook time or power.
  6. **AUTO COOK.** Touch this pad to cook microwavable foods without entering a cook time or power.
  7. **TIME DEFROST.** Touch this pad to set a defrost time.
  8. **AUTO DEFROST.** Touch this pad followed by number pads to thaw frozen meat by weight.
  9. **AUTO REHEAT.** Touch this pad to reheat microwavable foods without entering a cook time or power.
  10. **Number Pads.** Touch number pads to enter cooking times, cook powers, quantities, weights, or food categories.
  11. **TIME.** Touch this pad followed by number pads to set a cooking time.
  12. **POWER.** Touch this pad after the cook time has been set, followed by a Number Pad to set the amount of microwave energy released to cook the food. The higher the number, the higher the microwave power or "cooking speed."
  13. **STOP/CLEAR.** Touch this pad to erase an incorrect command, cancel a program during cooking, or to clear the Display.
  14. **TURNTABLE ON/OFF.** Touch this pad to turn off the turntable. "OFF" will appear in the display.
  15. **START.** Touch this pad to start a function. If you open the door after the oven begins to cook, retouch START.
  16. **LIGHT.** Touch this pad to turn the light on high, night(low), or off.
  17. **CLOCK.** Touch this pad to enter the correct time of day.
  18. **FAN.** Touch this pad to turn the fan on high, low, or off.
- NOTE: If you try to enter** incorrect instructions, you will not hear any tones. Touch STOP/Clear and re-enter the instructions.

# Using Your Microwave Oven

This section gives you instructions for operating each function. Please read these instructions carefully.

## AUDIBLE SIGNALS

Audible signals are available to guide you when setting and using your oven:



- **A programming tone will sound** each time you touch a pad.
- **Seven tones** signal the end of a Kitchen Timer countdown.
- **Four tones** signal the end of a cooking cycle.

## CLOCK

When your microwave oven is first plugged in or after a power failure, the Display will show “:”. If a time of day is not set, “:” will show on the Display until you touch “Clock”.

**Example: To set the clock for 10:30(AM or PM).**

**Touch:                                  Display Shows:**

- |    |   |       |
|----|---|-------|
| 1. |  | :     |
| 2. |  | 12:00 |
| 3. | 1 0 3 0   | 10:30 |
| 4. |  | 10:30 |

### NOTES:

- **If you enter** in an incorrect time and touch “Clock”, you cannot set time of day. Enter the correct time.
- **If you touch** STOP/Clear while setting the clock, the Display will show the last time of day set or “:” if no time of day has been set.

## INTERRUPTING COOKING

You can stop the oven during a cycle by opening the door. The oven stops heating and the fan stops, but the light stays on.

**To restart cooking, close** the door and **Touch START.**



**If you do not want to continue cooking, open the door and touch STOP/Clear.**

## CHILD LOCK

Use this safety feature to lock the control panel when you are cleaning the oven, or so that children cannot use the oven unsupervised.

**To set CHILD LOCK:**

**Touch:                                  Display Shows:**

- |    |   |  |
|----|---|--|
| 1. |  | :  |
| 2. |  | Touch and hold until “L” appears in the display. (approximately 4 seconds) |

**To cancel CHILD LOCK:**

**Touch:                                  Display Shows:**

- |    |   |   |
|----|---|---|
| 1. |  | Touch and hold until “L” disappears in the display. (approximately 4 seconds) |
|----|---|---|

## TURNTABLE ON/OFF

For best cooking results, leave the turntable on. It can be turned off for large dishes.

**Touch:** **Display Shows:**

1.  **Turntable On/Off**

OFF

2.  **Turntable On/Off**

ON

Press **Turntable On/Off** to turn the turntable on or off.

**NOTE:** Sometimes the turntable can become hot to touch. Be careful touching the turntable during and after cooking.

Do not run the oven empty without food in it.

## COOKTOP LIGHT

The pad on the bottom right of the control panel controls the cooktop light.

**Example: To set the Lamp for HIGH.**

**Touch:** **Display Shows:**

1.  **LIGHT HIGH/NIGHT/OFF**

:

once for HIGH light  
twice for NIGHT light

2.  **LIGHT HIGH/NIGHT/OFF**

:

To turn off, touch pad one or two times depending on light setting.

## EXHAUST FAN

The pad on the bottom center of the control panel controls the 2-speed exhaust fan.

**Example: To set the exhaust fan speed**

**Touch:** **Display Shows:**

1.  **FAN HI/LOW/OFF**

:

Once for HIGH  
Twice for Low

2.  **FAN HI/LOW/OFF**

:

Turn off fan when desired

**NOTE:** If the temperature from the range or cooktop below the oven gets too hot, the exhaust fan in the vent hood will automatically turn on at the HIGH setting to protect the oven.

It may stay on up to an hour to cool the oven.

When this occurs, the FAN pad will not turn the fan off. You cannot turn the exhaust fan off during microwave cooking.

## TIME DEFROST

Using TIME DEFROST can defrost for a selected length of time.

**Example: To set TIME DEFROST for 2 minutes.**

**Touch:** **Display Shows:**

1.  **TIME DEFROST**

: 0

2. 2 0 0

2:00

3.



Time counting down.



At the end of the Time defrost four tones will sound.

## TIMED COOKING

This feature lets you program a specific cook time and power. For best results, there are 10 power level settings in addition to HIGH (100%) power. Refer to the "Microwave Power Levels Table" on page 15 for more information.

**NOTE:** If you do not select a power level, the oven will automatically cook at HIGH (100%) power.





**Example: To cook for 5 minutes, 30 seconds at 80% power.**

Touch:	Display Shows:
1. 	: 0
2. 5 3 0	5 : 30
3. 	P-HI
4. 8	P-80
5. 	Time counting down and <b>COOK</b> .

## MULTI-STAGE COOKING

For best results, some recipes call for different cook powers during different stages of a cook cycle. You can program your oven to switch from one power level to another for up to 2 stages.

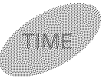
**Example: To set a 2-stage cook cycle.**

Touch:	Display Shows:
1. 	: 0
2. 3 0 0 to set a 3 minute cook time for first stage.	3 : 00
3. 	P-HI
4. 8 to set an 80% cook power for the first stage.	P-80
5. 	: 0
6. 7 0 0 to set a 7 minute cook time for second stage.	7 : 00
7. 	P-HI
8. 5 to set a 50% cook power for the second stage.	P-50
9. 	Time counting down and <b>COOK</b> .
10. When the first stage is over, you will hear two short tones as the oven begins the second cook stage.	

## MICROWAVE POWER LEVELS

For best results, some recipes call for different cook powers. The lower the cook power, the slower the cooking. Each number from 1 to 9 stands for a different percentage of full cook power.

The following chart gives the percentage of cook power each number pad stands for, and the cook power name usually used.

It also tells you when to use each cook power. Follow recipe or food package instructions if available.

**NOTE:** Refer to a reliable cookbook for cooking times based on the 1000 Watt cook power of your microwave oven.

COOK Power	NAME	WHEN TO USE IT
100% of full power	High	<ul style="list-style-type: none"> <li>• Quick heating many convenience foods and foods with high water content, such as soups and beverages.</li> <li>• Cooking tender cuts of meat, ground meat,</li> </ul>
9 = 90% of full power		<ul style="list-style-type: none"> <li>• Heating cream soups</li> </ul>
8 = 80% of full power		<ul style="list-style-type: none"> <li>• Heating rice, pasta, or casseroles</li> </ul>
7 = 70% of full power	Medium-High	<ul style="list-style-type: none"> <li>• Cooking and heating foods that need a Cook Power lower than high (for example, whole fish and meat loaf) or when food is cooking too fast</li> <li>• Reheating a single serving of food</li> </ul>
6 = 60% of full power		<ul style="list-style-type: none"> <li>• Cooking requiring special care, such as cheese and egg dishes, pudding, and custards</li> <li>• Finishing cooking casseroles</li> </ul>
5 = 50% of full power	Medium	<ul style="list-style-type: none"> <li>• Cooking ham, whole poultry, and pot roasts</li> <li>• Simmering stews</li> </ul>
4 = 40% of full power		<ul style="list-style-type: none"> <li>• Melting chocolate</li> <li>• Heating pastries</li> </ul>
3 = 30% of full power	Medium-Low, Defrost	<ul style="list-style-type: none"> <li>• Manually defrosting foods, such as bread, fish, meats, poultry, and precooked foods</li> </ul>
2 = 20% of full power		<ul style="list-style-type: none"> <li>• Softening butter, cheese, and ice cream</li> </ul>
1 = 10% of full power	Low	<ul style="list-style-type: none"> <li>• Keeping food warm</li> <li>• Taking chill out of fruit</li> </ul>

ENGLISH

**NOTE:** Once cook time has been entered, you can also use the Cook Power pad as a second Kitchen Timer by entering "0" for the Cook Power. The oven will count down the cooking time you set without cooking.



## AUTO DEFROST



Three defrost sequences are preset in the oven. The auto defrost feature provides you with the best defrosting method for frozen foods. The cooking guide will show you which defrost sequence is recommended for the food you are defrosting.

For added convenience, the Auto Defrost includes a built-in beep mechanism that reminds you to check, turn over, separate, or rearrange to get best defrost results. Three different defrosting levels are provided.

- 1 MEAT
- 2 POULTRY
- 3 FISH

\*Available weight is 0.1~6.0 lbs.

**Example: To defrost 1.2 lbs of ground beef.**

Touch:	Display Shows:
1. 	<i>dEF1</i>
2. 1	<i>0.1</i>
3. 1 and 2 to enter the weight	<i>1.2</i>
4. 	Time counting down.

**NOTE:**

When you touch the START pad, the display changes to defrost time count down. The oven will beep during the DEFROST cycle. At this time, open the door and turn, separate, or rearrange the food. Remove any portions that have thawed. Return frozen portions to the oven and touch START to resume the defrost cycle.

## OPERATING TIPS

- For best results, remove fish, shellfish, meat, and poultry from its original closed paper or plastic package (wrapper). Otherwise, the wrap will hold steam and juice close to the foods, which can cause the outer surface of the foods to cook.
- For best results, shape your ground meat into the form of a doughnut before freezing. When defrosting, scrape off thawed meat when the beep sounds and continue defrosting.
- Place foods in a shallow container or on a microwave roasting rack to catch drippings.

This table shows you food type selections and the weights you can set for each type. For best results, loosen or remove covering on food.

FOOD	TOUCH Auto Defrost	WEIGHTS YOU CAN SET (tenths of a pound)
Meat	1 Time(s)	.1 to 6.0 (45g to 2722g)
Poultry	2 Time(s)	.1 to 6.0 (45g to 2722g)
Fish	3 Time(s)	.1 to 6.0 (45g to 2722g)

## Weight conversion table

You are probably used to food weights as being in pounds and ounces that are fractions of a pound (for example, 4 ounces equals 1/4 pound). However, in order to enter food weight in Auto Defrost, you must specify pounds and tenths of a pound.

If the weight on the food package is in fractions of a pound, you can use the following table to convert the weight to decimals.

Equivalent Weight		
OUNCES	DECIMAL WEIGHT	
1.6	.10	
3.2	.20	
4.0	.25	One-Quarter Pound
4.8	.30	
6.4	.40	
8.0	.50	One-Half Pound
9.6	.60	
11.2	.70	
12.0	.75	Three-Quarters Pound
12.8	.80	
14.4	.90	
16.0	1.00	One Pound

**AUTO DEFROST TABLE**

**Meat setting**

FOOD	SETTING	AT BEEP	SPECIAL INSTRUCTIONS
<b>BEEF</b>			Meat of irregular shape and large, fatty cuts of meat should have the narrow or fatty areas shielded with foil at the beginning of a defrost sequence.
Ground Beef, Bulk	MEAT	Remove thawed portions with fork. Turn over. Return remainder to oven.	Do not defrost less than 1/4 lb. Freeze in doughnut shape.
Ground Beef, Patties	MEAT	Separate and rearrange.	Do not defrost less than 2 oz. patties. Depress center when freezing.
Round Steak	MEAT	Turn over. Cover warm areas with aluminum foil.	Place on a microwavable roasting rack.
Tenderloin Steak	MEAT	Turn over. Cover warm areas with aluminum foil.	Place on a microwavable roasting rack.
Stew Beef	MEAT	Remove thawed portions with fork. Separate remainder. Return remainder to oven.	Place in a microwavable baking dish.
Pot Roast, Chuck Roast	MEAT	Turn over. Cover warm areas with aluminum foil.	Place on a microwavable roasting rack.
Rib Roast	MEAT	Turn over. Cover warm areas with aluminum foil.	Place on a microwavable roasting rack.
Rolled Rump Roast	MEAT	Turn over. Cover warm areas with aluminum foil.	Place on a microwavable roasting rack.
<b>LAMB</b>			
Cubes for Stew	MEAT	Remove thawed portions with fork. Return remainder to oven.	Place in a microwavable baking dish.
Chops (1 inch thick)	MEAT	Separate and rearrange.	Place on a microwavable roasting rack.
<b>PORK</b>			
Chops (1/2 inch thick)	MEAT	Separate and rearrange.	Place on a microwavable roasting rack.
Hot Dogs	MEAT	Separate and rearrange.	Place on a microwavable roasting rack.
Spareribs Country-style Ribs	MEAT	Turn over. Cover warm areas with aluminum foil.	Place on a microwavable roasting rack.
Sausage, Links	MEAT	Separate and rearrange.	Place on a microwavable roasting rack.
Sausage, Bulk	MEAT	Remove thawed portions with fork. Turn over. Return remainder to oven.	Place in a microwavable baking dish.
Loin Roast, Boneless	MEAT	Turn over. Cover warm areas with aluminum foil.	Place on a microwavable roasting rack.

**ENGLISH**

**AUTO DEFROST TABLE (CONT.)**

**Poultry setting**

FOOD	SETTING	AT BEEP	SPECIAL INSTRUCTIONS
<b>CHICKEN</b> Whole (up to 6 lbs)	POULTRY	Turn over (finish defrosting breast-side down). Cover warm areas with aluminum foil.	Place chicken breast-side up on a microwavable roast rack. Finish defrosting by immersing in cold water. Remove giblets when chicken is partially defrosted.
Cut-up		Separate pieces and rearrange.  Turn over. Cover warm areas with aluminum foil.	Place on a microwavable roasting rack.  Finish defrosting by immersing in cold water.
<b>CORNISH HENS</b> Whole	POULTRY	Turn over. Cover warm areas with aluminum foil.	Place on a microwavable roasting rack. Finish defrosting by immersing in cold water.
<b>TURKEY</b> Breast (up to 6 lbs)	POULTRY	Turn over. Cover warm areas with aluminum foil.	Place on a microwavable roasting rack. Finish defrosting by immersing in cold water.

**Fish setting**

FOOD	SETTING	AT BEEP	SPECIAL INSTRUCTIONS
<b>FISH</b> Fillets	FISH	Turn over. Separate fillets when partially thawed if possible.	Place in a microwavable baking dish. Carefully separate fillets under cold water.
Steaks	FISH	Separate and rearrange.	Place in a microwavable baking dish. Run cold water over to finish defrosting.
Whole	FISH	Turn over.	Place in a microwavable baking dish. Cover head and tail with foil; do not let foil touch sides of microwave. Finish defrosting by immersing in cold water.
<b>SHELLFISH</b> Crabmeat	FISH	Break apart. Turn over.	Place in a microwavable baking dish.
Lobster tails	FISH	Turn over and rearrange.	Place in a microwavable baking dish.
Shrimp	FISH	Separate and rearrange.	Place in a microwavable baking dish.
Scallops	FISH	Separate and rearrange.	Place in a microwavable baking dish.

## DEFROSTING TIPS

- **When using** Auto Defrost, the weight to be entered is the net weight in pounds and tenths of pounds (the weight of the food minus the container).
- **Before starting**, make sure you have removed any of the metal twist-ties which often come with frozen food bags, and replace them with strings or elastic bands.
- **Open containers** such as cartons before they are placed in the oven.
- **Always slit** or pierce plastic pouches or packaging.
- **If food is foil wrapped**, remove foil and place it in a suitable container.
- **Slit** the skins, if any, of frozen food such as sausage.
- **Bend** plastic pouches of food to ensure even defrosting.
- **Always underestimate** defrosting time. If defrosted food is still icy in the center, return it to the microwave oven for more defrosting.
- **The length** of defrosting time varies according to how solidly the food is frozen.
- **The shape of the package** affects how quickly food will defrost. Shallow packages will defrost more quickly than a deep block.
- **As food begins to defrost**, separate the pieces. Separated pieces defrost more easily.
- **Use small pieces of aluminum foil** to shield parts of food such as chicken wings, leg tips, fish tails, or areas that start to get warm. Make sure the foil does not touch the sides, top, or bottom of the oven. The foil can damage the oven lining.
- **For better results**, let food stand after defrosting. (For more information on standing time, see the "Microwave Cooking Tips" section.)
- **Turn over** food during defrosting or standing time. Break apart and remove food as required.

# Using Quick Touch

Your oven's menu has been preprogrammed to cook food automatically. Tell the oven what you want. Then let your microwave oven cook your selections.

## POPCORN

Popcorn lets you pop 3.0, and 3.5 ounce bags of commercially packaged microwave popcorn. Pop only one package at a time. If you are using a microwave popcorn popper, follow manufacturer's instructions. To set your microwave oven correctly, follow this chart:

**Example: To pop a 3.0 oz. bag.**

**Touch:**                      **Display Shows:**



3.0

once for 3.5 oz  
twice for 3.0 oz

Time counting down and  
**COOK.**

When the cook time is over,  
you will hear four beeps and **End** will display.

## PIZZA

Pizza lets you reheat up to 3 slices of pizza. A slice is based on a 5 ounce slice.

**NOTE:**

- Place on a low plate & paper towel.
- Do not cover.

**Example: To reheat 2 slices of Pizza.**

**Touch:**                      **Display Shows:**



2

once for 1 slice  
twice for 2 slices  
three times for 3 slices

Time counting down and  
**COOK.**

When the cook time is over,  
you will hear four beeps and **End** will display.

## FROZEN ENTREE

Frozen Entree lets you cook 10 and 20 ounce plates of commercially packaged microwave frozen entree without entering cooking times and power levels.

Remove tray from outer carton.

Do not remove film cover, but cut it to vent.

**Example: To reheat a 20 oz. frozen entree.**

**Touch:**                      **Display Shows:**



20

once for 10 oz  
twice for 20 oz

Time counting down and  
**COOK.**

When the cook time is over,  
you will hear four beeps and **End** will display.

## POTATO

The Potato lets you cook potatoes with preset times and cook powers. You can choose from 1 to 4 potatoes.

**NOTE:**

- Cooking times are based on an average 8 ounce potato.
- Before baking, pierce potato with fork several times.
- After baking, let stand for 5 minutes.

**Example: To cook 2 Potatoes.**

**Touch:**                      **Display Shows:**



2

once for 1 potato  
twice for 2 potatoes  
three times for 3 potatoes  
four times for 4 potatoes

Time counting down and  
**COOK.**

When the cook time is over,  
you will hear four beeps and **End** will display.

## AUTO COOK

Auto Cook provides four preset categories for cooking.

**Example: To cook 2 cups of Casserole.**

**Touch:** **Display Shows:**

1.  AC-4

Choose food category.

Category	Touch pad of Time(s)
Fresh vegetable	1
Frozen vegetable	2
Rice	3
Casserole	4

**Touch:**

2. 2

**Display Shows:**

Time counting down and **COOK**.

Enter quantity/servings.

Category	Number of cups
Fresh vegetable	1 - 4 cups
Frozen vegetable	1 - 4 cups
Rice	1 - 2 cups
Casserole	1 - 4 cups

When the cook time is over, you will hear four beeps and **End** will display.

ENGLISH

## COOKING GUIDE FOR AUTO COOK

CODE	CATEGORY	QUANTITY	DIRECTIONS
1	FRESH VEGETABLE	1 cup	Place in a microwavable bowl or casserole. Add water according to the quantity. Cover with plastic wrap and vent. Let stand 3 minutes. * 1-2 cups: add 2 tbsp water. * 3-4 cups: add 2 tbsp water.
		2 cups	
		3 cups	
		4 cups	
2	FROZEN VEGETABLE	1 cup	Place in a microwavable bowl or casserole. Cover with plastic wrap and vent. Let stand 3 minutes. * 1-2 cups: add 2 tbsp water. * 3-4 cups: add 2 tbsp water.
		2 cups	
		3 cups	
		4 cups	
3	RICE	1 cup	Place in a microwavable bowl or casserole. Cover with plastic wrap and vent. Let stand 5 minutes.
		2 cups	
4	CASSEROLE	1 cup	Place in a microwavable bowl or casserole. Cover with plastic wrap and vent. Stir and let stand 3 minutes.
		2 cups	
		3 cups	
		4 cups	

## AUTO REHEAT

Auto Reheat provides four preset categories for reheating.

**Example: To reheat 2 servings of Dinner plate.**

**Touch:** **Display Shows:**

1.  rH-1

Choose food category.

Category	Touch pad of Time(s)
Dinner plate	1
Soup/sauce	2
Casserole	3
Roll/Muffin	4

**Touch:** **Display Shows:**

2. 2

Time counting down and **COOK.**

Enter quantity/servings.

Category	Number of cups/Items
Dinner plate	1-2 servings
Soup/sauce	1-4 cups
Casserole	1-4 cups
Roll/Muffin	1-4 pieces

When the cook time is over, you will hear four beeps and **End** will display.

## COOKING GUIDE FOR AUTO REHEAT

CODE	CATEGORY	SERVING AMOUNT	DIRECTION
1	DINNER PLATE	1 serving (10 oz.)	Place on a low plate. Cover with vented plastic wrap. Let stand 3 minutes.
		2 servings (15 oz.)	
2	SOUP/SAUCE	1 cup	Place in shallow microwavable casserole. Cover with vented plastic wrap. Stir and let stand 3 minutes.
		2 cups	
		3 cups	
		4 cups	
3	CASSEROLE	1 cup	Place in a microwavable bowl or casserole. Cover with plastic wrap. Stir and let stand 3 minutes.
		2 cups	
		3 cups	
		4 cups	
4	ROLL/MUFFIN	1 piece (2 oz.)	Place on paper towel. Do not cover.
		2 pieces (4 oz.)	
		3 pieces (6 oz.)	
		4 pieces (8 oz.)	

# Caring for Your Microwave Oven

To make sure your microwave oven looks good and works well for a long time, you should maintain it properly. For proper care, please follow these instructions carefully.

**For interior surfaces:** Wash often with warm, sudsy water and a sponge or soft cloth.

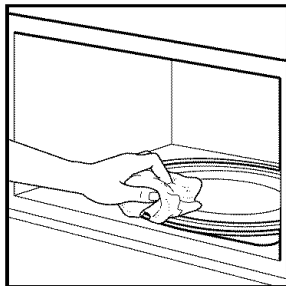

**Use** only mild, nonabrasive soaps or a mild detergent. **Be sure to keep the areas clean where the door and oven frame touch when closed.** Wipe well with clean cloth.

Over time, stains can occur on the surfaces as the result of food particles spattering during cooking. This is normal.

For stubborn soil, boil a cup of water in the oven for 2 to 3 minutes. Steam will soften the soil. To get rid of odors inside the oven, boil a cup of water with some lemon juice or vinegar in it.

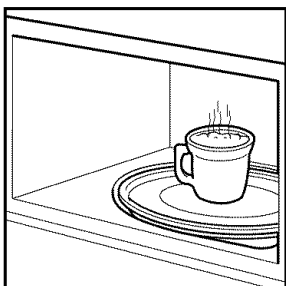

**To clean turntable and turntable support,** wash in

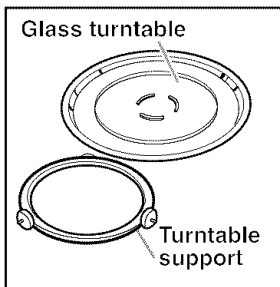

mild, sudsy water; for heavily soiled areas **use** a mild cleanser and scouring sponge. The turntable and turntable support are dishwasher safe.

**For exterior surfaces and control panel:** Use a soft

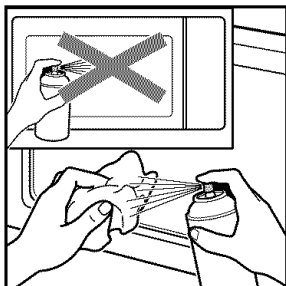

cloth with spray glass cleaner. Apply the spray glass cleaner to the soft cloth; do not spray directly on the oven.

**NOTE: Abrasive cleansers, steel wool pads, gritty wash cloths, some paper towels, etc., can dam-**

age the control panel and the interior and exterior oven surfaces.

ENGLISH



## CARING FOR THE FILTERS

The grease filters should be removed and cleaned often, at least once a month.

### Grease filters (Part No. 5230W1A012A):

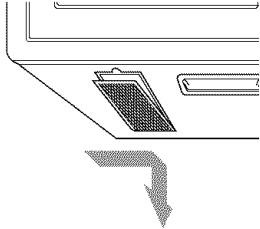

1. Unplug microwave oven or disconnect power.
2. To remove grease filters, slide each filter to the side. Pull filters downward and push to the other side. The filter will drop out.

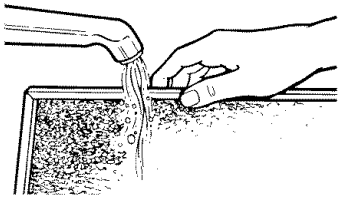

3. Soak grease filters in hot water and a mild detergent. Scrub and swish to remove embedded dirt and grease. Rinse well and shake to dry. Do not clean filters with ammonia, corrosive cleaning agents such as lye-based oven cleaners, or place them in a dishwasher. The filters will turn black or could be damaged.

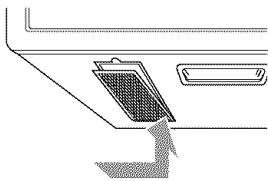

4. To replace grease filters, slide filter in the frame slot on one side of the opening. Push filter upward and push to the other side to lock into place.
5. Plug in microwave oven or reconnect power.

## REPLACING THE COOKTOP AND OVEN LIGHTS

### The cooktop light

1. Unplug microwave oven or disconnect power.

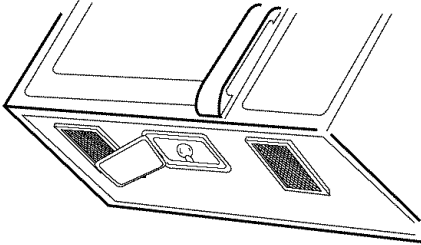

2. Remove the bulb cover mounting screws.
3. Replace bulb with candelabra-base 30-watt bulb (Part No. 6912W3Q001A) available from Sears by calling 1-800-4-MY-HOME®

4. Plug in microwave oven or reconnect power.

### The oven light

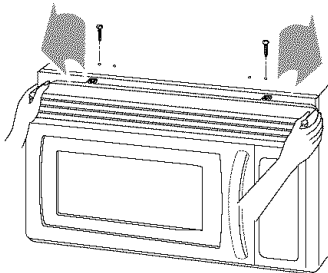

1. Unplug microwave oven or disconnect power.
2. Remove the vent grille mounting screws.
3. Tip the grille forward, then lift out to remove.

Bulb holder

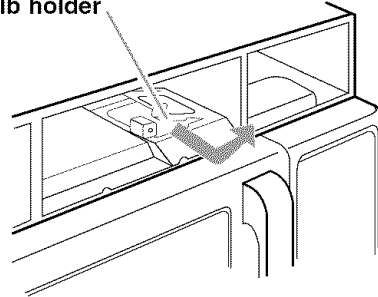

4. Lift up the bulb holder.

5. Replace the bulb with a candelabra-base 30-watt bulb (Part No. 6912W3Q001A) available from Sears by calling 1-800-4-MY-HOME®

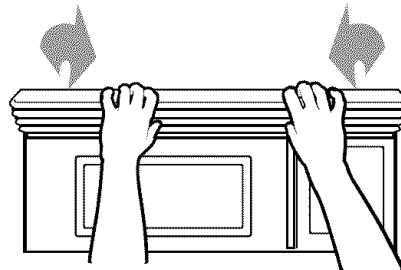

6. Slide the top of the vent grille into place. Push the bottom until it snaps into place. Replace the mounting screws.

7. Plug in microwave oven or reconnect power.

ENGLISH

## MICROWAVE COOKING TIPS

### Amount of food

- **If you increase or decrease** the amount of food you prepare, the time it takes to cook that food will also change. For example, if you double a recipe, add a little more than half the original cooking time. Check for doneness and, if necessary, add more time in small increments.

### Starting temperature of food

- **The lower the temperature** of the food being put into the microwave oven, the longer it takes to cook. Food at room temperature will be re-heated more quickly than food at refrigerator temperature.

### Composition of food

- **Food with a lot of fat and sugar** will be heated faster than food containing a lot of water. Fat and sugar will also reach a higher temperature than water in the cooking process.
- **The more dense the food**, the longer it takes to heat. "Very dense" food like meat takes longer to heat than lighter, more porous food like sponge cakes.

### Size and shape

- **Smaller pieces of food** will cook faster than larger pieces. Also, same shaped pieces cook more evenly than different-shaped pieces.
- **With foods that have different thicknesses**, the thinner parts will cook faster than the thicker parts. **Place** the thinner parts of chicken wings and legs in the center of the dish.

### Stirring, turning foods

- **Stirring and turning foods** spreads heat quickly to the center of the dish and avoids overcooking at the outer edges of the food.

### Covering food

Cover food to:

- **Reduce** splattering
- **Shorten** cooking times
- **Keep** food moist

You can use any covering that lets microwaves pass through. See "Getting to Know Your Microwave Oven" for materials that microwaves will pass through.

### Releasing pressure in foods

- **Several foods** (for example: baked potatoes, sausages, egg yolks, and some fruits) are tightly covered by a skin or membrane. Steam can build up under the membrane during cooking, causing the food to burst. To relieve the pressure and to prevent bursting, **pierce** these foods before cooking with a fork, cocktail pick, or toothpick.

### Using standing time

- **Always allow food to stand** after cooking. Standing time after defrosting and cooking allows the temperature to evenly spread throughout the food, improving the cooking results.
- **The length of the standing time** depends on how much food you are cooking and how dense it is. Sometimes it can be as short as the time it takes you to remove the food from the oven and take it to the serving table. However, with larger, denser food, the standing time may be as long as 10 minutes.

### Arranging food

For best results, place food evenly on the plate. You can do this in several ways:

- **If you are cooking several items of the same food**, such as baked potatoes, **place** them in a ring pattern for uniform cooking.
- **When cooking foods of uneven shapes or thickness, such as chicken breasts**, **place** the smaller or thinner area of the food towards the center of the dish where it will be heated last.
- **Layer thin slices of meat** on top of each other.
- **When you cook or reheat whole fish**, **score** the skin – this prevents cracking.
- **Do not** let food or a container touch the top or sides of the oven. This will prevent possible arcing.

### Using aluminum foil

Metal containers should not be used in a microwave oven. There are, however, some exceptions. If you have purchased food which is prepackaged in an aluminum foil container, refer to the instructions on the package. When using aluminum foil containers, cooking times may be longer because microwaves will only penetrate the top of the food. If you use aluminum containers without package instructions, follow these guidelines:

## MICROWAVE COOKING TIPS (CONT.)

### Using aluminum foil (cont.)

- **Place** the container in a glass bowl and add some water so that it covers the bottom of the container, not more than 1/4 in. (.64 cm) high. This ensures even heating of the container bottom.
- **Always remove** the lid to avoid damage to the oven.
- **Use only** undamaged containers.
- **Do not use** containers taller than 3/4 in. (1.9 cm).
- **Container must be** at least half filled.
- **To avoid arcing**, there must be a minimum 1/4 in. (.64 cm) between the aluminum container and the walls of the oven and also between two aluminum containers.
- **Always place** the container on the turntable.
- **Shield** with small pieces of aluminum foil, parts of food that may cook quickly, such as wing tips and leg ends of poultry.
- **Heating food** in aluminum foil containers usually takes up to double the time compared to reheating in plastic, glass, china, or paper containers.  
The time when food is ready will vary depending upon the type of container you use.
- **Let food stand** for 2 to 3 minutes after heating so that heat is spread evenly throughout container.

### Cooking you should not do in your microwave oven

- **Do not** do canning of foods in the oven. Closed glass jars may explode, resulting in damage to the oven.
- **Do not** use the microwave oven to sterilize objects (baby bottles, etc.). It is difficult to keep the oven at the high temperature needed for sterilization.

# Questions and Answers

QUESTIONS	ANSWERS
Can I operate my microwave oven without the turntable or turn the turntable over to hold a large dish?	No. If you remove or turn over the turntable, you will get poor cooking results. Dishes used in your oven must fit on the turntable.
Can I use either metal or aluminum pans in my microwave oven?	You can use aluminum foil for shielding (use small, flat pieces), small skewers, and shallow foil trays (if tray is not taller than 3/4 in. [1.9 cm] deep and is filled with food to absorb microwave energy). Never allow metal to touch walls or door.
Is it normal for the turntable to turn in either direction?	Yes. The turntable rotates clockwise or counter-clockwise, depending on the rotation of the motor when the cooking cycle begins.
Sometimes the door of my microwave oven appears wavy. Is this normal?	This appearance is normal and does not affect the operation of your oven.
What are the humming noises that I hear when my microwave oven is operating?	You may hear the sound of the transformer when the magnetron tube cycles on.
Why does the dish become hot when I microwave food in it? I thought that this should not happen.	As the food becomes hot it will conduct the heat to the dish. Be prepared to use hot pads to remove food after cooking.
What does "standing time" mean?	"Standing time" means that food should be removed from the oven and covered for additional time to allow it to finish cooking. This frees the oven for other cooking.
Why does steam come out of the air exhaust vent?	Steam is normally produced during cooking. The microwave oven has been designed to vent this steam out the vents.
Can I pop popcorn in my microwave oven? How do I get the best results?	Yes. Pop packaged microwave popcorn following manufacturer's guidelines. Do not use regular paper bags. Do not repop unpopped kernels. Do not pop popcorn in glass cookware.

# Troubleshooting

Most cooking problems often are caused by little things you can find and fix without tools of any kind. Check the lists below and on the next page before calling for assistance or service. If you still need help, call Sears Service at 1-800-4-MY-HOME®

## MICROWAVE OVEN DOES NOT WORK

PROBLEM	CAUSE
Nothing works.	<ul style="list-style-type: none"><li>• The power supply cord is not plugged into a grounded 3 prong outlet. (See the Electrical Requirements" section on page 6 and the "Electrical connection" section on Page 8.)</li><li>• A household fuse has blown or a circuit breaker has tripped.</li><li>• The electric company has had a power failure.</li></ul>
The microwave oven will not run.	<ul style="list-style-type: none"><li>• You are using the oven as a timer. Touch STOP/Clear to cancel the Kitchen Timer.</li><li>• The door is not firmly closed and latched.</li><li>• You did not touch START.</li><li>• You did not follow directions exactly.</li><li>• An operation that you set earlier is still running. Touch STOP/Clear to cancel that operation.</li></ul>

ENGLISH

## COOKING TIMES

PROBLEM	CAUSE
Food is not cooked enough.	<ul style="list-style-type: none"><li>• The electric supply to your home or wall outlets is low or lower than normal. Your electric company can tell you if the line voltage is low. Your electrician or service technician can tell you if the outlet voltage is low.</li><li>• The cook power is not at the recommended setting. Check the chart on Page 15.</li></ul>
The display shows a time counting down but the oven is not cooking.	<ul style="list-style-type: none"><li>• The oven door is not closed completely.</li><li>• You have set the controls as a kitchen timer. Touch STOP/Clear to cancel the Kitchen Timer.</li></ul>

## TURNTABLE

PROBLEM	CAUSE
The turntable will not turn.	<ul style="list-style-type: none"> <li>• The turntable is not correctly in place. It should be correct-side up and sitting firmly on the center hub.</li> <li>• The support is not operating correctly. Remove the turntable and restart the oven. If the support still does not move, call Sears Service at 1-800-4-MY-HOME®. Cooking without the turntable can give you poor results.</li> </ul>

## TONES

PROBLEM	CAUSE
You do not hear the programming or end-of-cycle tone.	<ul style="list-style-type: none"> <li>• You have not entered the correct command.</li> </ul>

## DISPLAY MESSAGES

PROBLEM	CAUSE
The display is flashing “:”.	<ul style="list-style-type: none"> <li>• There has been a power interruption. Reset the clock. (See the “Clock” section on Page 12.)</li> </ul>

If none of these items are causing your problem, call Sears Service at 1-800-4-MY-HOME®

# Galaxy<sup>®</sup>

Microwave Hood Combination

Use & Care Guide

Combinación Microondas Campana

Guía de uso y cuidado

Models/Modelos 721.80022

721.80029

ENGLISH

ESPAÑOL

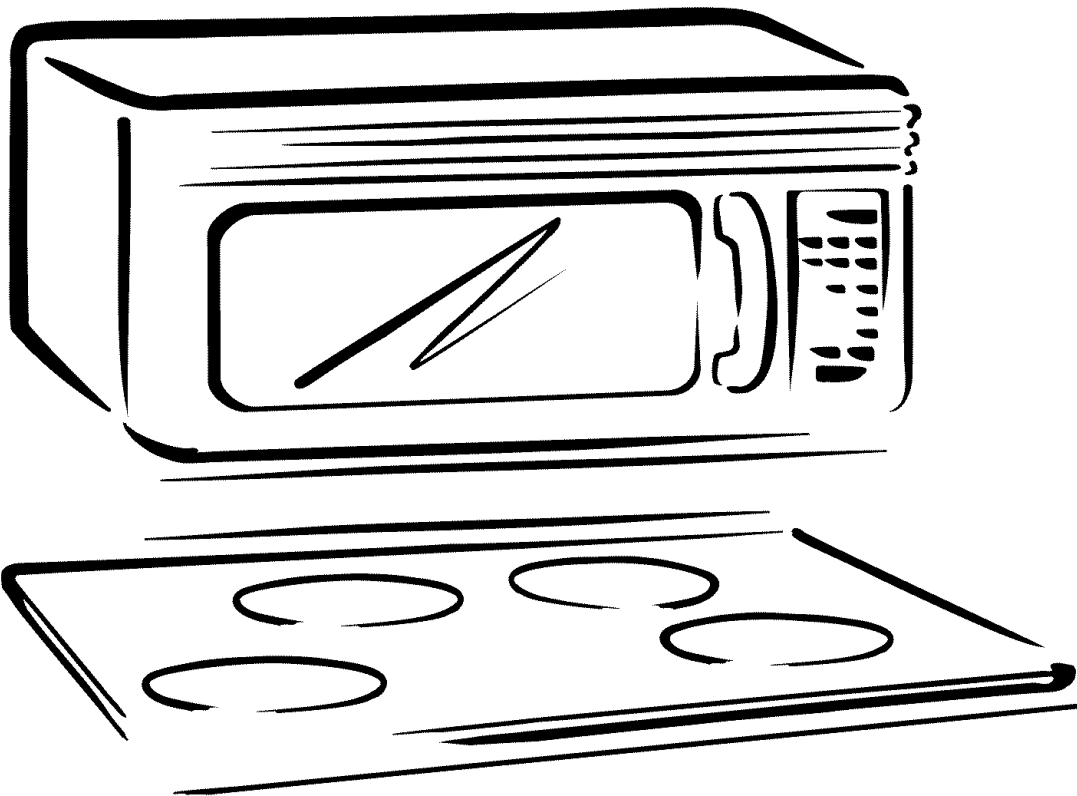



# Table of Contents

Warranty .....	2
Sears Service.....	3
Microwave Oven Safety .....	4
Getting to Know Your Microwave Oven .....	7
How your microwave oven works .....	7
Radio interference .....	7
For the best cooking results .....	7
Cookware guide .....	8
Operating safety precautions .....	8
Electrical connection .....	8
Specifications .....	9
Microwave oven features .....	9
Control panel features.....	10
Using Your Microwave Oven .....	12
Audible Signals .....	12
Interrupting Cooking.....	12
Clock .....	12
Child Lock .....	12
Turntable On/Off.....	13
Cooktop Light.....	13
Time Defrost .....	13
Exhaust Fan.....	13
Timed Cooking.....	14
Multi-stage Cooking .....	14
Microwave Power Levels .....	15
Auto Defrost .....	16
Operating Tips .....	16
Auto defrost table.....	17
Auto defrost table (Cont.).....	18
Defrosting tips .....	19
Using Quick Touch.....	20
Auto Cook .....	21
Cooking guide for Auto Cook .....	21
Auto Reheat .....	22
Cooking guide for Auto Reheat.....	22
Caring for Your Microwave Oven .....	23
Caring for the filters.....	24
Replacing the cooktop and oven lights .....	25
Microwave Cooking Tips.....	26~27
Questions and Answers .....	28
Troubleshooting.....	29~30
Service .....	Back cover

# Microwave Hood Combination Warranty

## One Year Limited Warranty

When installed, operated and maintained according to all instructions supplied with the product, if this appliance fails due to a defect in material or workmanship within one year from the date of purchase, call 1-800-4-MY-HOME® to arrange for free repair.

### This warranty covers only defects in material and workmanship. Sears will NOT pay for:

1. Expendable items that can wear out from normal use, including but not limited to filters, belts, light bulbs, and bags.
2. A service technician to instruct the user in correct product installation, operation or maintenance.
3. A service technician to clean or maintain this product.
4. Damage to or failure of this product if it is not installed, operated or maintained according to all instructions supplied with the product.
5. Damage to or failure of this product resulting from accident, abuse, misuse or use for other than its intended purpose.
6. Damage to or failure of this product caused by the use of detergents, cleaners, chemicals or utensils other than those recommended in all instructions supplied with the product.
7. Damage to or failure of parts or systems resulting from unauthorized modifications made to this product.

### Disclaimer of implied warranties; limitation of remedies

Customer's sole and exclusive remedy under this limited warranty shall be product repair as provided herein. Implied warranties, including warranties of merchantability or fitness for a particular purpose, are limited to one year or the shortest period allowed by law. Sears shall not be liable for incidental or consequential damages. Some states and provinces do not allow the exclusion or limitation of incidental or consequential damages, or limitations on the duration of implied warranties of merchantability or fitness, so these exclusions or limitations may not apply to you.

This warranty applies only while this appliance is used in the United States and Canada.

This warranty gives you specific legal rights, and you may also have other rights which vary from state to state.

Sears, Roebuck and Co., Dept. 817WA, Hoffman Estates, IL 60179  
Sears Canada Inc., Toronto, Ontario, Canada M5B 2B8

# Sears Service

## Master Protection Agreement

*Congratulations on making a smart purchase.*

Your new Kenmore® product is designed and manufactured for years of dependable operation. But like all products, it may require preventive maintenance or repair from time to time.

The Master Protection Agreement also helps extend the life of your new product. Here's what the Agreement\* includes:

- ✓ **Parts and labor** needed to help keep products operating properly **under normal use**, not just defects. Our coverage goes **well beyond the product warranty**. No deductibles, no functional failure excluded from coverage - **real protection**.
- ✓ **Expert service** by a force of more than **10,000 authorized Sears service technicians**, which means someone you can trust will be working on your product.
- ✓ **Unlimited service calls and nationwide service**, as often as you want us, whenever you want us.
- ✓ **"No-lemon" guarantee** - replacement of your covered product if four or more product failures occur within twelve months.
- ✓ **Product replacement** if your covered product can't be fixed.
- ✓ **Annual Preventive Maintenance Check** at your request - no extra charge.
- ✓ **Fast help by phone** - we call it **Rapid Resolution** - phone support from a Sears representative on all products. Think of us as a "talking owner's manual."
- ✓ **Power surge protection** against electrical damage due to power fluctuations.
- ✓ **\$250 Food Loss Protection** annually for any food spoilage that is the result of mechanical failure of any covered refrigerator or freezer.
- ✓ **Rental reimbursement** if repair of your covered product takes longer than promised.
- ✓ **10% discount** off the regular price of any non-covered repair service and related installed parts.

Once you purchase the Agreement, a simple phone call is all that it takes for you to schedule service. You can call anytime day or night, or schedule a service appointment online

The Master Protection Agreement is a risk free purchase. If you can-cel for any reason during the product warranty period, we will provide a full refund. Or, a prorated refund anytime after the product warranty period expires.

Purchase your Master Protection Agreement today!

**Some limitations and exclusions apply. For prices and additional information in the U.S.A. call 1-800-827-6655.**

**\* Coverage in Canada varies on some items. For full details call Sears Canada at 1-800-361-6665.**

### Sears Installation Service

**For Sears professional installation** of home appliances, garage door openers, water heaters, and other major home items, in the U.S.A. or Canada call **1-800-4-MY-HOME®**.

ENGLISH

# Microwave Oven Safety

## Your safety and the safety of others is very important.

We have provided many important safety messages in this manual and on your microwave oven. Always read and obey all safety messages.



This is the safety alert symbol.

This symbol alerts you to hazards that can kill or hurt you and others.

All safety messages will be preceded by the safety alert symbol and the word "DANGER" or "WARNING." These words mean:

**⚠ DANGER**

**You will be killed or seriously injured if you don't follow instructions immediately.**

**⚠ WARNING**

**You can be killed or seriously injured if you don't follow instructions.**

All safety messages will identify the hazard, tell you how to reduce the chance of injury, and tell you what can happen if the instructions are not followed.

## IMPORTANT SAFETY INSTRUCTIONS

When using electrical appliances, basic safety precautions should be followed, including the following:

**⚠WARNING:** To reduce the risk of burns, electric shock, fire, injury to persons, or exposure to excessive microwave energy:

- Read all instructions before using the microwave oven.
- Read and follow the specific "PRECAUTIONS TO AVOID POSSIBLE EXPOSURE TO EXCESSIVE MICROWAVE ENERGY" found on page 6.
- The microwave oven must be grounded. Connect only to properly grounded outlet. See "GROUNDING INSTRUCTIONS" found on page 4,5 and 6.
- Install or locate the microwave oven only in accordance with the provided installation instructions.
- Some products such as whole eggs in the shell and sealed containers – for example, closed glass jars – are able to explode and should not be heated in the microwave oven.
- Use the microwave oven only for its intended use as described in this manual. Do not use corrosive chemicals or vapors in the microwave oven. This type of oven is specifically designed to heat, cook, or dry food. It is not designed for industrial or laboratory use.
- As with any appliance, close supervision is necessary when used by children.
- Do not operate the microwave oven if it has a damaged cord or plug, if it is not working properly, or if it has been damaged or dropped.

**SAVE THESE INSTRUCTIONS**

## IMPORTANT SAFETY INSTRUCTIONS

- The microwave oven should be serviced only by qualified service technician. Call an authorized service company for examination, repair, or adjustment.
- See door surface cleaning instructions in the “Caring for Your Microwave Oven” section.
- To reduce the risk of fire in the oven cavity:
  - Do not overcook food. Carefully attend the microwave oven when paper, plastic, or other combustible materials are placed inside the oven to facilitate cooking.
  - Remove wire twist-ties from paper or plastic bags before placing bags in oven.
  - If materials inside the oven ignite, keep oven door closed, turn oven off, and disconnect the power cord, or shut off power at the fuse or circuit breaker panel.
  - Do not use the cavity for storage purposes. Do not leave paper products, cooking utensils, or food in the cavity when not in use.
- Suitable for use above both gas and electric cooking equipment.
- Intended to be used above ranges with maximum width of 36 inches (91 cm).
- Clean Ventilating Hoods Frequently -Grease should not be allowed to accumulate on hood or filter.
- When flaming foods under the hood, turn the fan on.
- Use care when cleaning the vent-hood filter. Corrosive cleaning agents, such as lye-based oven cleaners, may damage the filter.
- Oversized foods or oversized metal utensils should not be inserted in the microwave oven as they may create a fire or risk of electric shock.
- Do not clean with metal scouring pads. Pieces can burn off the pad and touch electrical parts involving a risk of electric shock.
- Do not store anything directly on top of the microwave oven when the microwave oven is in operation.
- Do not cover or block any openings on the microwave oven.
- Do not store this microwave oven outdoors. Do not use the microwave oven near water - for example, near a kitchen sink, in a wet basement, near a swimming pool, or similar location.
- Do not immerse cord or plug in water.
- Keep cord away from heated surfaces.
- Do not let cord hang over edge of table or counter.
- Do not mount over a sink.
- Do not cover racks or any other part of the oven with metal foil. This will cause overheating of the oven.
- Liquids such as water, coffee, or tea are able to be overheated beyond the boiling point without appearing to be boiling due to surface tension of the liquid. Visible bubbling or boiling when the container is removed from the microwave oven is not always present. This could result in very hot liquids suddenly boiling over when a spoon or other utensil is inserted into the liquid. To reduce the risk of injury to persons;
  - 1) Do not overheat the liquid.
  - 2) Stir the liquid both before and halfway through heating it.
  - 3) Do not use straight-sided containers with narrow necks.
  - 4) After heating, allow the container to stand in the microwave oven for a short time before removing the container.
  - 5) Use extreme care when inserting utensils into the container.

**SAVE THESE INSTRUCTIONS**

**ENGLISH**

## PRECAUTIONS TO AVOID POSSIBLE EXPOSURE TO EXCESSIVE MICROWAVE ENERGY

- (a) Do not attempt to operate this oven with the door open since open-door operation can result in harmful exposure to microwave energy. It is important not to defeat or tamper with the safety interlocks.
- (b) Do not place any object between the oven front face and the door, or allow soil or cleaner residue to accumulate on sealing surfaces.
- (c) Do not operate the oven if it is damaged. It is particularly important that the oven door close properly and that there is no damage to the:
  - (1) Door (bent).
  - (2) Hinges and latches (broken or loosened).
  - (3) Door seals and sealing surfaces.
- (d) The oven should not be adjusted or repaired by anyone except properly qualified service technician.

## Electrical requirements

Observe all governing codes and ordinances. A 120-Volt, 60-Hz, AC-only, 15- or 20-amp fused electrical supply is required. (A time-delay fuse is recommended.) It is recommended that a separate circuit serving only this appliance be provided.

**⚠ DANGER**



**Electrical Shock Hazard**  
 Plug into a grounded 3 prong outlet. Do not remove ground prong. Do not use an adapter. Do not use an extension cord. Failure to follow these instructions can result in death, fire, or electrical shock.

## GROUNDING INSTRUCTIONS

• **For all cord connected appliances:** The microwave oven must be grounded. In the event of an electrical short circuit, grounding reduces the risk of electric shock by providing an escape wire for the electric current. The microwave oven is equipped with a cord having a grounding wire with a grounding plug. The plug must be plugged into an outlet that is properly installed and grounded.

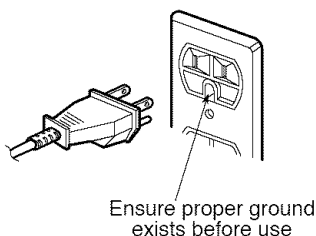

**⚠ WARNING:** Improper grounding can result in a risk of electric shock. Consult a qualified electrician or service technician if you do not understand the grounding instructions or if you wonder whether the appliance is properly grounded. Do not use an extension cord. If the power supply cord is too short, have a qualified electrician or service technician install an outlet near the microwave oven.

• **For a permanently connected appliance:** This appliance has a short power supply cord to reduce the risk of anyone tripping over or becoming entangled in the cord. The microwave oven must be connected to a grounded, metallic, permanent wiring system, or an equipment grounding conductor should be run with the circuit conductors and connected to the equipment grounding terminal or lead on the microwave oven.

**SAVE THESE INSTRUCTIONS**

# Getting to Know Your Microwave Oven

This section discusses the concepts behind microwave cooking. It also shows you the basics you need to know to operate your microwave oven. Please read this information before you use your oven.

## How your microwave oven works

**Microwave ovens are safe.** Microwave energy is not hot. It causes food to make its own heat, and it's this heat that cooks the food.

Microwaves are like TV waves, radio waves, or light waves. You cannot see them, but you can see what they do.

**A magnetron** in the microwave oven produces microwaves. The microwaves move into the oven where they contact food as it turns on the turntable.

**The glass turntable** of your microwave oven lets microwaves pass through. Then they bounce off a metal floor, back through the glass turntable, and are absorbed by the food.

**Microwaves** pass through most glass, paper, and plastics without heating them so food absorbs the energy. Microwaves bounce off metal containers so food does not absorb the energy.

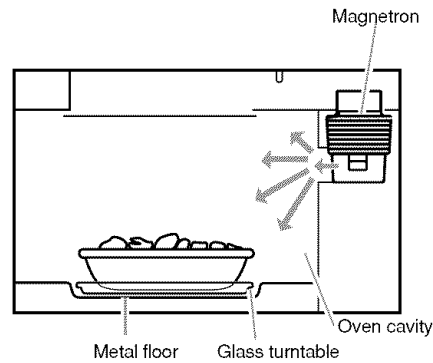

ENGLISH

## Radio interference

Using your microwave oven may cause interference to your radio, TV, or similar equipment. When there is interference, you can reduce it or remove it by:

- **Cleaning** the door and sealing surfaces of the oven.
- **Adjusting** the receiving antenna of the radio or television.
- **Moving** the receiver away from the microwave oven.
- **Plugging** the microwave oven into a different outlet so that the microwave oven and receiver are on different branch circuits.

## For the best cooking results

- **Always cook food** for the shortest cooking time recommended. Check to see how the food is cooking. If needed, touch Add Minute while the oven is operating or after the cooking cycle is over (see the "Using add minute" section).
- **Stir, turn over, or rearrange** the food being cooked about halfway through the cooking time for all recipes. This will help make sure the food is evenly cooked.
- **If you do not have a cover for a dish**, use wax paper, or microwave-approved paper towels or plastic wrap. Remember to turn back a corner of the plastic wrap to vent steam during cooking.

## Cookware guide

**Most heat resistant, nonmetallic cookware is safe for use in your microwave oven. However, to test cookware before using, follow these steps:**

1. Place the empty cookware in the microwave oven.
2. Measure 1 cup (250ml) water in a glass measuring cup and place it in the oven beside the cookware.
3. Microwave on 100% power for 1 minute. If the dish is warm, it should not be used for microwave cooking.

## Operating safety precautions

- **Never** lean on the door or allow a child to swing on it when the door is open.
- **Use hot pads.** Microwave energy does not heat containers, but the heat from the food can make the container hot.
- **Do not** use newspaper or other printed paper in the oven.
- **Do not** dry flowers, fruit, herbs, wood, paper, gourds, or clothes in the oven.
- **Do not** start a microwave oven when it is empty. Product life may be shortened. If you practice programming the oven, **put** a container of water in the oven. It is normal for the oven door to look wavy after the oven has been running for a while.
- **Do not** try to melt paraffin wax in the oven. Paraffin wax will not melt in a microwave oven because it allows microwaves to pass through it.
- **Do not** operate the microwave oven unless the glass turntable is securely in place and can rotate freely. The turntable can rotate in either direction. **Make sure** the turntable is correct-side up in the oven. **Handle your turntable with care** when removing it from the oven to avoid possibly breaking it. If your turntable cracks or breaks, contact your dealer for a replacement.
- **When you use a browning dish**, the browning dish bottom must be at least 3/16 inch above the turntable. Follow the directions supplied with the browning dish.
- **Never cook or reheat a whole egg inside the shell.** Steam buildup in whole eggs may cause them to burst, and possibly damage the oven. **Slice** hard-boiled eggs before heating. In rare cases, poached eggs have been known to explode. **Cover** poached eggs and **allow** a standing time of one minute before cutting into them.
- **For best results, stir any liquid several times during heating or reheating.** Liquids heated in certain containers (especially containers shaped like cylinders) may become overheated. The liquid may splash out with a loud noise during or after heating or when adding ingredients (coffee granules, tea bags, etc.). This can harm the oven.
- **Microwaves** may not reach the center of a roast. The heat spreads to the center from the outer, cooked areas just as in regular oven cooking. This is one of the reasons for letting some foods (for example, roasts or baked potatoes) stand for a while after cooking, or for stirring some foods during the cooking time.
- **Do not deep fry in the oven.** Microwavable utensils are not suitable and it is difficult to maintain appropriate deep-frying temperatures.
- **Do not overcook potatoes.** At the end of the recommended cooking time, potatoes should be slightly firm because they will continue cooking during standing time. **After microwaving, let** potatoes stand for 5 minutes. They will finish cooking while standing.

## Electrical connection

**If your electric power line or outlet voltage** is less than 110 volts, cooking times may be longer. Have a qualified electrician check your electrical system.

## Specifications

Power Supply	120V AC, 60 Hz
Rated Power Consumption	1500W
Microwave Output	*1000W
Rated Current	14.0A
Overall Dimensions(WxHxD)	29 15/16" x 16 7/16" x 15 3/8"
Oven Cavity Dimensions(WxHxD)	21 9/16" x 9 1/10" x 14 1/8"
Capacity of Oven Cavity	1.5 cu.ft

\*IEC 60705 RATING STANDARD

Specifications subject to change without prior notice.

## Microwave oven features

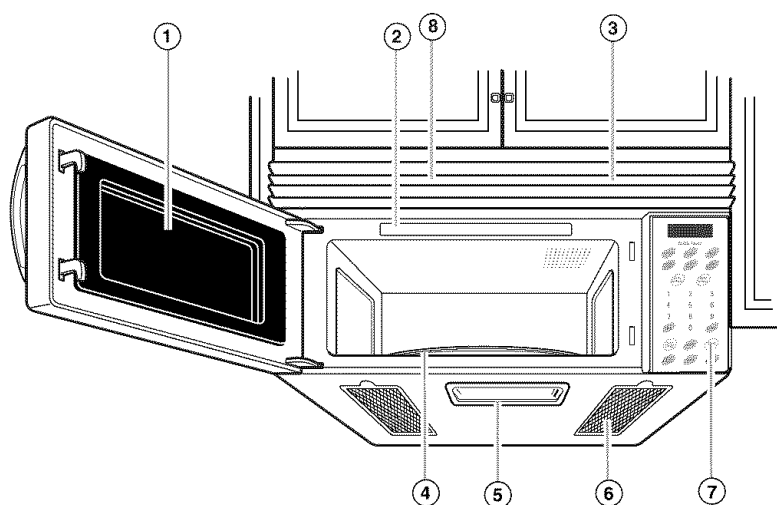

Your microwave oven is designed to make your cooking experience as enjoyable and productive as possible. To get you up and running quickly, the following is a list of the oven's basic features:

- 1. Metal Shielded Window** The shield prevents microwaves from escaping. It is designed as a screen to allow you to view food as it cooks.
- 2. Model and Serial Number Plate & Cooking Guide Label**

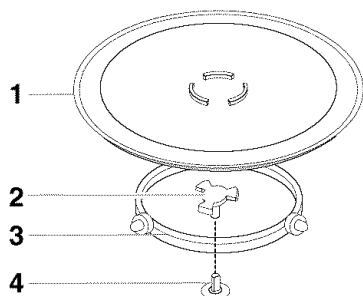

- 3. Vent Grille**
- 4. Turntable.** The turntable turns food as it cooks for more even cooking. It must be in the oven during operation for best cooking results.
- 5. Cooktop Light**
- 6. Grease Filters.** See "Caring for the filters" section.
- 7. Control Panel.** Touch the pads on this panel to perform all functions.
- 8. Charcoal Filter** (behind Vent Grille)

The turntable rotates in both directions to help cook food more evenly. Do not operate the microwave oven without the turntable in place.

### To Install:

1. Place the support on the oven cavity bottom.
2. Place the turntable on the support.  
Fit the raised, curved lines in the center of the turntable bottom between the three spokes of the hub.  
The rollers on the support should fit inside the turntable bottom ridge.



## Control panel features

Your microwave oven control panel lets you select the desired cooking function quickly and easily. All you have to do is touch the necessary Command Pad. The following is a list of all the Command and Number Pads located on the control panel. **For more information on these features, see “Using your microwave oven” section.**

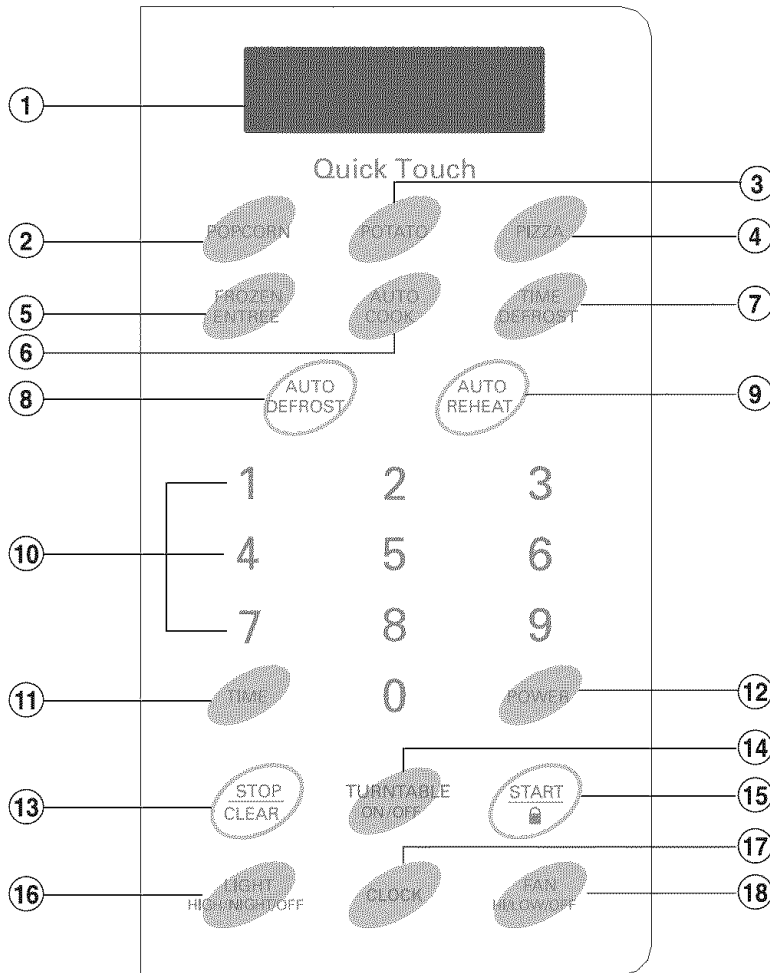

**1. Display.** The display includes a clock and indicators to tell you time of day, cooking time settings, cook powers, quantities, weights and cooking functions selected.

**2. POPCORN.** Touch this pad to pop one of 2 bag sizes of popcorn without entering a cook time or power.

3. **POTATO.** Touch this pad to cook up to 4 potatoes without entering a cook time or power.
  4. **PIZZA.** Touch this pad to reheat one or several slices of pizza without entering a cook time or power.
  5. **FROZEN ENTREE.** Touch this pad to cook a 10 - to 20 - ounce (284 to 567 g) frozen entree without entering a cook time or power.
  6. **AUTO COOK.** Touch this pad to cook microwavable foods without entering a cook time or power.
  7. **TIME DEFROST.** Touch this pad to set a defrost time.
  8. **AUTO DEFROST.** Touch this pad followed by number pads to thaw frozen meat by weight.
  9. **AUTO REHEAT.** Touch this pad to reheat microwavable foods without entering a cook time or power.
  10. **Number Pads.** Touch number pads to enter cooking times, cook powers, quantities, weights, or food categories.
  11. **TIME.** Touch this pad followed by number pads to set a cooking time.
  12. **POWER.** Touch this pad after the cook time has been set, followed by a Number Pad to set the amount of microwave energy released to cook the food. The higher the number, the higher the microwave power or "cooking speed."
  13. **STOP/CLEAR.** Touch this pad to erase an incorrect command, cancel a program during cooking, or to clear the Display.
  14. **TURNTABLE ON/OFF.** Touch this pad to turn off the turntable. "OFF" will appear in the display.
  15. **START.** Touch this pad to start a function. If you open the door after the oven begins to cook, retouch START.
  16. **LIGHT.** Touch this pad to turn the light on high, night(low), or off.
  17. **CLOCK.** Touch this pad to enter the correct time of day.
  18. **FAN.** Touch this pad to turn the fan on high, low, or off.
- NOTE: If you try to enter** incorrect instructions, you will not hear any tones. Touch STOP/Clear and re-enter the instructions.



## TURNTABLE ON/OFF

For best cooking results, leave the turntable on. It can be turned off for large dishes.

**Touch:** **Display Shows:**

1.  **Turntable On/Off**

OFF

2.  **Turntable On/Off**

ON

Press **Turntable On/Off** to turn the turntable on or off.

**NOTE:** Sometimes the turntable can become hot to touch. Be careful touching the turntable during and after cooking.

Do not run the oven empty without food in it.

## COOKTOP LIGHT

The pad on the bottom right of the control panel controls the cooktop light.

**Example: To set the Lamp for HIGH.**

**Touch:** **Display Shows:**

1.  **LIGHT HIGH/NIGHT/OFF**

:

once for HIGH light  
twice for NIGHT light

2.  **LIGHT HIGH/NIGHT/OFF**

:

To turn off, touch pad one or two times depending on light setting.

## EXHAUST FAN

The pad on the bottom center of the control panel controls the 2-speed exhaust fan.

**Example: To set the exhaust fan speed**

**Touch:** **Display Shows:**

1.  **FAN HI/LOW/OFF**

:

Once for HIGH  
Twice for Low

2.  **FAN HI/LOW/OFF**

:

Turn off fan when desired

**NOTE:** If the temperature from the range or cooktop below the oven gets too hot, the exhaust fan in the vent hood will automatically turn on at the HIGH setting to protect the oven.

It may stay on up to an hour to cool the oven.

When this occurs, the FAN pad will not turn the fan off. You cannot turn the exhaust fan off during microwave cooking.

## TIME DEFROST

Using TIME DEFROST can defrost for a selected length of time.

**Example: To set TIME DEFROST for 2 minutes.**

**Touch:** **Display Shows:**

1.  **TIME DEFROST**

: 0

2. 2 0 0

2:00

3.



Time counting down.



At the end of the Time defrost four tones will sound.

## TIMED COOKING

This feature lets you program a specific cook time and power. For best results, there are 10 power level settings in addition to HIGH (100%) power. Refer to the "Microwave Power Levels Table" on page 15 for more information.

**NOTE:** If you do not select a power level, the oven will automatically cook at HIGH (100%) power.

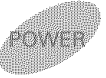



**Example:** To cook for 5 minutes, 30 seconds at 80% power.

Touch:	Display Shows:
1. 	: 0
2. 5 3 0	5 : 30
3. 	P-HI
4. 8	P-80
5. 	Time counting down and <b>COOK</b> .

## MULTI-STAGE COOKING

For best results, some recipes call for different cook powers during different stages of a cook cycle. You can program your oven to switch from one power level to another for up to 2 stages.

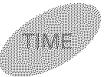
**Example:** To set a 2-stage cook cycle.

Touch:	Display Shows:
1. 	: 0
2. 3 0 0 to set a 3 minute cook time for first stage.	3 : 00
3. 	P-HI
4. 8 to set an 80% cook power for the first stage.	P-80
5. 	: 0
6. 7 0 0 to set a 7 minute cook time for second stage.	7 : 00
7. 	P-HI
8. 5 to set a 50% cook power for the second stage.	P-50
9. 	Time counting down and <b>COOK</b> .
10. When the first stage is over, you will hear two short tones as the oven begins the second cook stage.	

## MICROWAVE POWER LEVELS

For best results, some recipes call for different cook powers. The lower the cook power, the slower the cooking. Each number from 1 to 9 stands for a different percentage of full cook power.

The following chart gives the percentage of cook power each number pad stands for, and the cook power name usually used.

It also tells you when to use each cook power. Follow recipe or food package instructions if available.

**NOTE:** Refer to a reliable cookbook for cooking times based on the 1000 Watt cook power of your microwave oven.

COOK Power	NAME	WHEN TO USE IT
100% of full power	High	<ul style="list-style-type: none"> <li>• Quick heating many convenience foods and foods with high water content, such as soups and beverages.</li> <li>• Cooking tender cuts of meat, ground meat,</li> </ul>
9 = 90% of full power		<ul style="list-style-type: none"> <li>• Heating cream soups</li> </ul>
8 = 80% of full power		<ul style="list-style-type: none"> <li>• Heating rice, pasta, or casseroles</li> </ul>
7 = 70% of full power	Medium-High	<ul style="list-style-type: none"> <li>• Cooking and heating foods that need a Cook Power lower than high (for example, whole fish and meat loaf) or when food is cooking too fast</li> <li>• Reheating a single serving of food</li> </ul>
6 = 60% of full power		<ul style="list-style-type: none"> <li>• Cooking requiring special care, such as cheese and egg dishes, pudding, and custards</li> <li>• Finishing cooking casseroles</li> </ul>
5 = 50% of full power	Medium	<ul style="list-style-type: none"> <li>• Cooking ham, whole poultry, and pot roasts</li> <li>• Simmering stews</li> </ul>
4 = 40% of full power		<ul style="list-style-type: none"> <li>• Melting chocolate</li> <li>• Heating pastries</li> </ul>
3 = 30% of full power	Medium-Low, Defrost	<ul style="list-style-type: none"> <li>• Manually defrosting foods, such as bread, fish, meats, poultry, and precooked foods</li> </ul>
2 = 20% of full power		<ul style="list-style-type: none"> <li>• Softening butter, cheese, and ice cream</li> </ul>
1 = 10% of full power	Low	<ul style="list-style-type: none"> <li>• Keeping food warm</li> <li>• Taking chill out of fruit</li> </ul>

ENGLISH

**NOTE:** Once cook time has been entered, you can also use the Cook Power pad as a second Kitchen Timer by entering "0" for the Cook Power. The oven will count down the cooking time you set without cooking.

## AUTO DEFROST



Three defrost sequences are preset in the oven. The auto defrost feature provides you with the best defrosting method for frozen foods. The cooking guide will show you which defrost sequence is recommended for the food you are defrosting.

For added convenience, the Auto Defrost includes a built-in beep mechanism that reminds you to check, turn over, separate, or rearrange to get best defrost results. Three different defrosting levels are provided.

- 1 MEAT
- 2 POULTRY
- 3 FISH

\*Available weight is 0.1~6.0 lbs.

**Example: To defrost 1.2 lbs of ground beef.**

Touch:	Display Shows:
1. 	<i>dEF1</i>
2. 1	<i>0.1</i>
3. 1 and 2 to enter the weight	<i>1.2</i>
4. 	Time counting down.

**NOTE:**

When you touch the START pad, the display changes to defrost time count down. The oven will beep during the DEFROST cycle. At this time, open the door and turn, separate, or rearrange the food. Remove any portions that have thawed. Return frozen portions to the oven and touch START to resume the defrost cycle.

## OPERATING TIPS

- For best results, remove fish, shellfish, meat, and poultry from its original closed paper or plastic package (wrapper). Otherwise, the wrap will hold steam and juice close to the foods, which can cause the outer surface of the foods to cook.
- For best results, shape your ground meat into the form of a doughnut before freezing. When defrosting, scrape off thawed meat when the beep sounds and continue defrosting.
- Place foods in a shallow container or on a microwave roasting rack to catch drippings.

This table shows you food type selections and the weights you can set for each type. For best results, loosen or remove covering on food.

FOOD	TOUCH Auto Defrost	WEIGHTS YOU CAN SET (tenths of a pound)
Meat	1 Time(s)	.1 to 6.0 (45g to 2722g)
Poultry	2 Time(s)	.1 to 6.0 (45g to 2722g)
Fish	3 Time(s)	.1 to 6.0 (45g to 2722g)

## Weight conversion table

You are probably used to food weights as being in pounds and ounces that are fractions of a pound (for example, 4 ounces equals 1/4 pound). However, in order to enter food weight in Auto Defrost, you must specify pounds and tenths of a pound.

If the weight on the food package is in fractions of a pound, you can use the following table to convert the weight to decimals.

Equivalent Weight		
OUNCES	DECIMAL WEIGHT	
1.6	.10	
3.2	.20	
4.0	.25	One-Quarter Pound
4.8	.30	
6.4	.40	
8.0	.50	One-Half Pound
9.6	.60	
11.2	.70	
12.0	.75	Three-Quarters Pound
12.8	.80	
14.4	.90	
16.0	1.00	One Pound

**AUTO DEFROST TABLE**

**Meat setting**

FOOD	SETTING	AT BEEP	SPECIAL INSTRUCTIONS
<b>BEEF</b>			Meat of irregular shape and large, fatty cuts of meat should have the narrow or fatty areas shielded with foil at the beginning of a defrost sequence.
Ground Beef, Bulk	MEAT	Remove thawed portions with fork. Turn over. Return remainder to oven.	Do not defrost less than 1/4 lb. Freeze in doughnut shape.
Ground Beef, Patties	MEAT	Separate and rearrange.	Do not defrost less than 2 oz. patties. Depress center when freezing.
Round Steak	MEAT	Turn over. Cover warm areas with aluminum foil.	Place on a microwavable roasting rack.
Tenderloin Steak	MEAT	Turn over. Cover warm areas with aluminum foil.	Place on a microwavable roasting rack.
Stew Beef	MEAT	Remove thawed portions with fork. Separate remainder. Return remainder to oven.	Place in a microwavable baking dish.
Pot Roast, Chuck Roast	MEAT	Turn over. Cover warm areas with aluminum foil.	Place on a microwavable roasting rack.
Rib Roast	MEAT	Turn over. Cover warm areas with aluminum foil.	Place on a microwavable roasting rack.
Rolled Rump Roast	MEAT	Turn over. Cover warm areas with aluminum foil.	Place on a microwavable roasting rack.
<b>LAMB</b>			
Cubes for Stew	MEAT	Remove thawed portions with fork. Return remainder to oven.	Place in a microwavable baking dish.
Chops (1 inch thick)	MEAT	Separate and rearrange.	Place on a microwavable roasting rack.
<b>PORK</b>			
Chops (1/2 inch thick)	MEAT	Separate and rearrange.	Place on a microwavable roasting rack.
Hot Dogs	MEAT	Separate and rearrange.	Place on a microwavable roasting rack.
Spareribs Country-style Ribs	MEAT	Turn over. Cover warm areas with aluminum foil.	Place on a microwavable roasting rack.
Sausage, Links	MEAT	Separate and rearrange.	Place on a microwavable roasting rack.
Sausage, Bulk	MEAT	Remove thawed portions with fork. Turn over. Return remainder to oven.	Place in a microwavable baking dish.
Loin Roast, Boneless	MEAT	Turn over. Cover warm areas with aluminum foil.	Place on a microwavable roasting rack.

**ENGLISH**



## AUTO DEFROST TABLE (CONT.)

### Poultry setting

FOOD	SETTING	AT BEEP	SPECIAL INSTRUCTIONS
<b>CHICKEN</b> Whole (up to 6 lbs)	POULTRY	Turn over (finish defrosting breast-side down). Cover warm areas with aluminum foil.	Place chicken breast-side up on a microwavable roast rack. Finish defrosting by immersing in cold water. Remove giblets when chicken is partially defrosted.
Cut-up		Separate pieces and rearrange.  Turn over. Cover warm areas with aluminum foil.	Place on a microwavable roasting rack.  Finish defrosting by immersing in cold water.
<b>CORNISH HENS</b> Whole	POULTRY	Turn over. Cover warm areas with aluminum foil.	Place on a microwavable roasting rack. Finish defrosting by immersing in cold water.
<b>TURKEY</b> Breast (up to 6 lbs)	POULTRY	Turn over. Cover warm areas with aluminum foil.	Place on a microwavable roasting rack. Finish defrosting by immersing in cold water.

### Fish setting

FOOD	SETTING	AT BEEP	SPECIAL INSTRUCTIONS
<b>FISH</b> Fillets	FISH	Turn over. Separate fillets when partially thawed if possible.	Place in a microwavable baking dish. Carefully separate fillets under cold water.
Steaks	FISH	Separate and rearrange.	Place in a microwavable baking dish. Run cold water over to finish defrosting.
Whole	FISH	Turn over.	Place in a microwavable baking dish. Cover head and tail with foil; do not let foil touch sides of microwave. Finish defrosting by immersing in cold water.
<b>SHELLFISH</b> Crabmeat	FISH	Break apart. Turn over.	Place in a microwavable baking dish.
Lobster tails	FISH	Turn over and rearrange.	Place in a microwavable baking dish.
Shrimp	FISH	Separate and rearrange.	Place in a microwavable baking dish.
Scallops	FISH	Separate and rearrange.	Place in a microwavable baking dish.

## DEFROSTING TIPS

- **When using** Auto Defrost, the weight to be entered is the net weight in pounds and tenths of pounds (the weight of the food minus the container).
- **Before starting**, make sure you have removed any of the metal twist-ties which often come with frozen food bags, and replace them with strings or elastic bands.
- **Open containers** such as cartons before they are placed in the oven.
- **Always slit** or pierce plastic pouches or packaging.
- **If food is foil wrapped**, remove foil and place it in a suitable container.
- **Slit** the skins, if any, of frozen food such as sausage.
- **Bend** plastic pouches of food to ensure even defrosting.
- **Always underestimate** defrosting time. If defrosted food is still icy in the center, return it to the microwave oven for more defrosting.
- **The length** of defrosting time varies according to how solidly the food is frozen.
- **The shape of the package** affects how quickly food will defrost. Shallow packages will defrost more quickly than a deep block.
- **As food begins to defrost**, separate the pieces. Separated pieces defrost more easily.
- **Use small pieces of aluminum foil** to shield parts of food such as chicken wings, leg tips, fish tails, or areas that start to get warm. Make sure the foil does not touch the sides, top, or bottom of the oven. The foil can damage the oven lining.
- **For better results**, let food stand after defrosting. (For more information on standing time, see the "Microwave Cooking Tips" section.)
- **Turn over** food during defrosting or standing time. Break apart and remove food as required.

# Using Quick Touch

Your oven's menu has been preprogrammed to cook food automatically. Tell the oven what you want. Then let your microwave oven cook your selections.

## POPCORN

Popcorn lets you pop 3.0, and 3.5 ounce bags of commercially packaged microwave popcorn. Pop only one package at a time. If you are using a microwave popcorn popper, follow manufacturer's instructions. To set your microwave oven correctly, follow this chart:

**Example: To pop a 3.0 oz. bag.**

**Touch:** **Display Shows:**



3.0

once for 3.5 oz  
twice for 3.0 oz

Time counting down and  
**COOK.**

When the cook time is over,  
you will hear four beeps and **End** will display.

## PIZZA

Pizza lets you reheat up to 3 slices of pizza. A slice is based on a 5 ounce slice.

**NOTE:**

- Place on a low plate & paper towel.
- Do not cover.

**Example: To reheat 2 slices of Pizza.**

**Touch:** **Display Shows:**



2

once for 1 slice  
twice for 2 slices  
three times for 3 slices

Time counting down and  
**COOK.**

When the cook time is over,  
you will hear four beeps and **End** will display.

## FROZEN ENTREE

Frozen Entree lets you cook 10 and 20 ounce plates of commercially packaged microwave frozen entree without entering cooking times and power levels.

Remove tray from outer carton.

Do not remove film cover, but cut it to vent.

**Example: To reheat a 20 oz. frozen entree.**

**Touch:** **Display Shows:**



20

once for 10 oz  
twice for 20 oz

Time counting down and  
**COOK.**

When the cook time is over,  
you will hear four beeps and **End** will display.

## POTATO

The Potato lets you cook potatoes with preset times and cook powers. You can choose from 1 to 4 potatoes.

**NOTE:**

- Cooking times are based on an average 8 ounce potato.
- Before baking, pierce potato with fork several times.
- After baking, let stand for 5 minutes.

**Example: To cook 2 Potatoes.**

**Touch:** **Display Shows:**



2

once for 1 potato  
twice for 2 potatoes  
three times for 3 potatoes  
four times for 4 potatoes

Time counting down and  
**COOK.**

When the cook time is over,  
you will hear four beeps and **End** will display.

## AUTO COOK

Auto Cook provides four preset categories for cooking.

**Example: To cook 2 cups of Casserole.**

**Touch:** **Display Shows:**

1.  *AC-4*

Choose food category.

Category	Touch pad of Time(s)
Fresh vegetable	1
Frozen vegetable	2
Rice	3
Casserole	4

**Touch:**

2. **2**

**Display Shows:**

Time counting down and **COOK**.

Enter quantity/servings.

Category	Number of cups
Fresh vegetable	1 - 4 cups
Frozen vegetable	1 - 4 cups
Rice	1 - 2 cups
Casserole	1 - 4 cups

When the cook time is over, you will hear four beeps and **End** will display.

**ENGLISH**

## COOKING GUIDE FOR AUTO COOK

CODE	CATEGORY	QUANTITY	DIRECTIONS
1	FRESH VEGETABLE	1 cup	Place in a microwavable bowl or casserole. Add water according to the quantity. Cover with plastic wrap and vent. Let stand 3 minutes. * 1-2 cups: add 2 tbsp water. * 3-4 cups: add 2 tbsp water.
		2 cups	
		3 cups	
		4 cups	
2	FROZEN VEGETABLE	1 cup	Place in a microwavable bowl or casserole. Cover with plastic wrap and vent. Let stand 3 minutes. * 1-2 cups: add 2 tbsp water. * 3-4 cups: add 2 tbsp water.
		2 cups	
		3 cups	
		4 cups	
3	RICE	1 cup	Place in a microwavable bowl or casserole. Cover with plastic wrap and vent. Let stand 5 minutes.
		2 cups	
4	CASSEROLE	1 cup	Place in a microwavable bowl or casserole. Cover with plastic wrap and vent. Stir and let stand 3 minutes.
		2 cups	
		3 cups	
		4 cups	



# Caring for Your Microwave Oven

To make sure your microwave oven looks good and works well for a long time, you should maintain it properly. For proper care, please follow these instructions carefully.

**For interior surfaces:** Wash often with warm, sudsy water and a sponge or soft cloth.

**Use** only mild, nonabrasive soaps or a mild detergent. **Be sure to keep the areas clean where the door and oven frame touch when closed.** Wipe well with clean cloth.

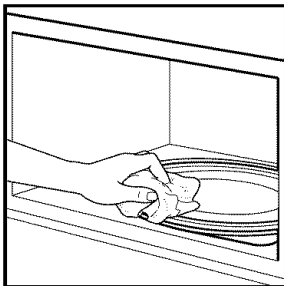

Over time, stains can occur on the surfaces as the result of food particles spattering during cooking. This is normal.

For stubborn soil, boil a cup of water in the oven for 2 to 3 minutes. Steam will soften the soil. To get rid of odors inside the oven, boil a cup of water with some lemon juice or vinegar in it.

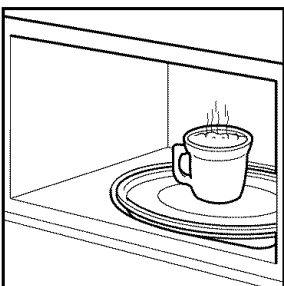

**For exterior surfaces and control panel:** Use a soft cloth with spray glass cleaner. Apply the spray glass cleaner to the soft cloth; do not spray directly on the oven.

**NOTE: Abrasive cleansers, steel wool pads, gritty wash cloths, some paper towels, etc., can damage the control panel and the interior and exterior oven surfaces.**

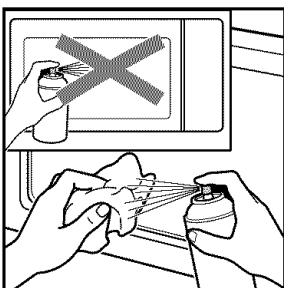

**To clean turntable and turntable support, wash in**

mild, sudsy water; for heavily soiled areas **use** a mild cleanser and scouring sponge. The turntable and turntable support are dishwasher safe.

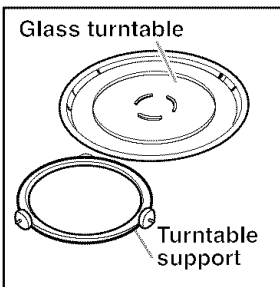

ENGLISH

## CARING FOR THE FILTERS

The grease filters should be removed and cleaned often, at least once a month.

### Grease filters (Part No. 5230W1A012A):

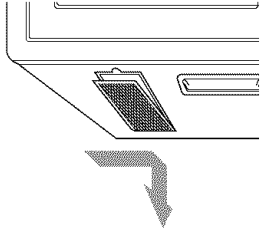

1. Unplug microwave oven or disconnect power.
2. To remove grease filters, slide each filter to the side. Pull filters downward and push to the other side. The filter will drop out.

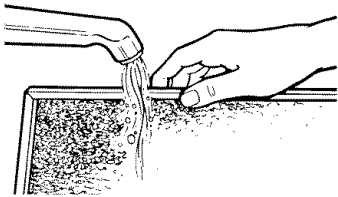

3. Soak grease filters in hot water and a mild detergent. Scrub and swish to remove embedded dirt and grease. Rinse well and shake to dry. Do not clean filters with ammonia, corrosive cleaning agents such as lye-based oven cleaners, or place them in a dishwasher. The filters will turn black or could be damaged.

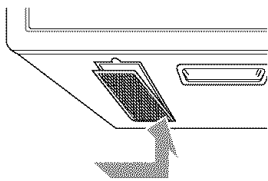

4. To replace grease filters, slide filter in the frame slot on one side of the opening. Push filter upward and push to the other side to lock into place.
5. Plug in microwave oven or reconnect power.

## REPLACING THE COOKTOP AND OVEN LIGHTS

### The cooktop light

1. Unplug microwave oven or disconnect power.

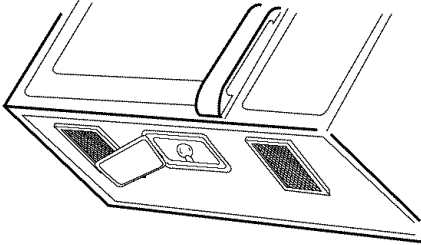

2. Remove the bulb cover mounting screws.
3. Replace bulb with candelabra-base 30-watt bulb (Part No. 6912W3Q001A) available from Sears by calling 1-800-4-MY-HOME®

4. Plug in microwave oven or reconnect power.

### The oven light

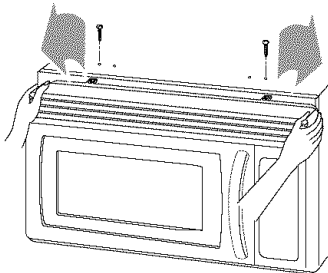

1. Unplug microwave oven or disconnect power.
2. Remove the vent grille mounting screws.
3. Tip the grille forward, then lift out to remove.

Bulb holder

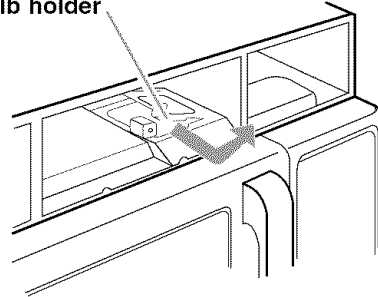

4. Lift up the bulb holder.

5. Replace the bulb with a candelabra-base 30-watt bulb (Part No. 6912W3Q001A) available from Sears by calling 1-800-4-MY-HOME®

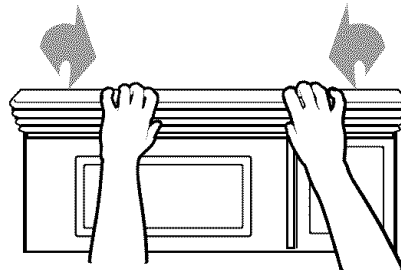

6. Slide the top of the vent grille into place. Push the bottom until it snaps into place. Replace the mounting screws.

7. Plug in microwave oven or reconnect power.

ENGLISH



## MICROWAVE COOKING TIPS

### Amount of food

- **If you increase or decrease** the amount of food you prepare, the time it takes to cook that food will also change. For example, if you double a recipe, add a little more than half the original cooking time. Check for doneness and, if necessary, add more time in small increments.

### Starting temperature of food

- **The lower the temperature** of the food being put into the microwave oven, the longer it takes to cook. Food at room temperature will be re-heated more quickly than food at refrigerator temperature.

### Composition of food

- **Food with a lot of fat and sugar** will be heated faster than food containing a lot of water. Fat and sugar will also reach a higher temperature than water in the cooking process.
- **The more dense the food**, the longer it takes to heat. "Very dense" food like meat takes longer to heat than lighter, more porous food like sponge cakes.

### Size and shape

- **Smaller pieces of food** will cook faster than larger pieces. Also, same shaped pieces cook more evenly than different-shaped pieces.
- **With foods that have different thicknesses**, the thinner parts will cook faster than the thicker parts. **Place** the thinner parts of chicken wings and legs in the center of the dish.

### Stirring, turning foods

- **Stirring and turning foods** spreads heat quickly to the center of the dish and avoids overcooking at the outer edges of the food.

### Covering food

Cover food to:

- **Reduce** splattering
- **Shorten** cooking times
- **Keep** food moist

You can use any covering that lets microwaves pass through. See "Getting to Know Your Microwave Oven" for materials that microwaves will pass through.

### Releasing pressure in foods

- **Several foods** (for example: baked potatoes, sausages, egg yolks, and some fruits) are tightly covered by a skin or membrane. Steam can build up under the membrane during cooking, causing the food to burst. To relieve the pressure and to prevent bursting, **pierce** these foods before cooking with a fork, cocktail pick, or toothpick.

### Using standing time

- **Always allow food to stand** after cooking. Standing time after defrosting and cooking allows the temperature to evenly spread throughout the food, improving the cooking results.
- **The length of the standing time** depends on how much food you are cooking and how dense it is. Sometimes it can be as short as the time it takes you to remove the food from the oven and take it to the serving table. However, with larger, denser food, the standing time may be as long as 10 minutes.

### Arranging food

For best results, place food evenly on the plate. You can do this in several ways:

- **If you are cooking several items of the same food**, such as baked potatoes, **place** them in a ring pattern for uniform cooking.
- **When cooking foods of uneven shapes or thickness, such as chicken breasts**, **place** the smaller or thinner area of the food towards the center of the dish where it will be heated last.
- **Layer thin slices of meat** on top of each other.
- **When you cook or reheat whole fish**, **score** the skin – this prevents cracking.
- **Do not** let food or a container touch the top or sides of the oven. This will prevent possible arcing.

### Using aluminum foil

Metal containers should not be used in a microwave oven. There are, however, some exceptions. If you have purchased food which is prepackaged in an aluminum foil container, refer to the instructions on the package. When using aluminum foil containers, cooking times may be longer because microwaves will only penetrate the top of the food. If you use aluminum containers without package instructions, follow these guidelines:

## MICROWAVE COOKING TIPS (CONT.)

### Using aluminum foil (cont.)

- **Place** the container in a glass bowl and add some water so that it covers the bottom of the container, not more than 1/4 in. (.64 cm) high. This ensures even heating of the container bottom.
- **Always remove** the lid to avoid damage to the oven.
- **Use only** undamaged containers.
- **Do not use** containers taller than 3/4 in. (1.9 cm).
- **Container must be** at least half filled.
- **To avoid arcing**, there must be a minimum 1/4 in. (.64 cm) between the aluminum container and the walls of the oven and also between two aluminum containers.
- **Always place** the container on the turntable.
- **Shield** with small pieces of aluminum foil, parts of food that may cook quickly, such as wing tips and leg ends of poultry.
- **Heating food** in aluminum foil containers usually takes up to double the time compared to reheating in plastic, glass, china, or paper containers.  
The time when food is ready will vary depending upon the type of container you use.
- **Let food stand** for 2 to 3 minutes after heating so that heat is spread evenly throughout container.

### Cooking you should not do in your microwave oven

- **Do not** do canning of foods in the oven. Closed glass jars may explode, resulting in damage to the oven.
- **Do not** use the microwave oven to sterilize objects (baby bottles, etc.). It is difficult to keep the oven at the high temperature needed for sterilization.

# Questions and Answers

QUESTIONS	ANSWERS
Can I operate my microwave oven without the turntable or turn the turntable over to hold a large dish?	No. If you remove or turn over the turntable, you will get poor cooking results. Dishes used in your oven must fit on the turntable.
Can I use either metal or aluminum pans in my microwave oven?	You can use aluminum foil for shielding (use small, flat pieces), small skewers, and shallow foil trays (if tray is not taller than 3/4 in. [1.9 cm] deep and is filled with food to absorb microwave energy). Never allow metal to touch walls or door.
Is it normal for the turntable to turn in either direction?	Yes. The turntable rotates clockwise or counter-clockwise, depending on the rotation of the motor when the cooking cycle begins.
Sometimes the door of my microwave oven appears wavy. Is this normal?	This appearance is normal and does not affect the operation of your oven.
What are the humming noises that I hear when my microwave oven is operating?	You may hear the sound of the transformer when the magnetron tube cycles on.
Why does the dish become hot when I microwave food in it? I thought that this should not happen.	As the food becomes hot it will conduct the heat to the dish. Be prepared to use hot pads to remove food after cooking.
What does "standing time" mean?	"Standing time" means that food should be removed from the oven and covered for additional time to allow it to finish cooking. This frees the oven for other cooking.
Why does steam come out of the air exhaust vent?	Steam is normally produced during cooking. The microwave oven has been designed to vent this steam out the vents.
Can I pop popcorn in my microwave oven? How do I get the best results?	Yes. Pop packaged microwave popcorn following manufacturer's guidelines. Do not use regular paper bags. Do not repop unpopped kernels. Do not pop popcorn in glass cookware.

# Troubleshooting

Most cooking problems often are caused by little things you can find and fix without tools of any kind. Check the lists below and on the next page before calling for assistance or service. If you still need help, call Sears Service at 1-800-4-MY-HOME®

## MICROWAVE OVEN DOES NOT WORK

PROBLEM	CAUSE
Nothing works.	<ul style="list-style-type: none"><li>• The power supply cord is not plugged into a grounded 3 prong outlet. (See the Electrical Requirements" section on page 6 and the "Electrical connection" section on Page 8.)</li><li>• A household fuse has blown or a circuit breaker has tripped.</li><li>• The electric company has had a power failure.</li></ul>
The microwave oven will not run.	<ul style="list-style-type: none"><li>• You are using the oven as a timer. Touch STOP/Clear to cancel the Kitchen Timer.</li><li>• The door is not firmly closed and latched.</li><li>• You did not touch START.</li><li>• You did not follow directions exactly.</li><li>• An operation that you set earlier is still running. Touch STOP/Clear to cancel that operation.</li></ul>

ENGLISH

## COOKING TIMES

PROBLEM	CAUSE
Food is not cooked enough.	<ul style="list-style-type: none"><li>• The electric supply to your home or wall outlets is low or lower than normal. Your electric company can tell you if the line voltage is low. Your electrician or service technician can tell you if the outlet voltage is low.</li><li>• The cook power is not at the recommended setting. Check the chart on Page 15.</li></ul>
The display shows a time counting down but the oven is not cooking.	<ul style="list-style-type: none"><li>• The oven door is not closed completely.</li><li>• You have set the controls as a kitchen timer. Touch STOP/Clear to cancel the Kitchen Timer.</li></ul>

## TURNTABLE

PROBLEM	CAUSE
The turntable will not turn.	<ul style="list-style-type: none"> <li>• The turntable is not correctly in place. It should be correct-side up and sitting firmly on the center hub.</li> <li>• The support is not operating correctly. Remove the turntable and restart the oven. If the support still does not move, call Sears Service at 1-800-4-MY-HOME®. Cooking without the turntable can give you poor results.</li> </ul>

## TONES

PROBLEM	CAUSE
You do not hear the programming or end-of-cycle tone.	<ul style="list-style-type: none"> <li>• You have not entered the correct command.</li> </ul>

## DISPLAY MESSAGES

PROBLEM	CAUSE
The display is flashing “:”.	<ul style="list-style-type: none"> <li>• There has been a power interruption. Reset the clock. (See the “Clock” section on Page 12.)</li> </ul>

If none of these items are causing your problem, call Sears Service at 1-800-4-MY-HOME®

# Galaxy<sup>®</sup>

Microwave Hood Combination

Use & Care Guide

Combinación Microondas Campana

Guía de uso y cuidado

Models/Modelos 721.80022

721.80029

ENGLISH

ESPAÑOL

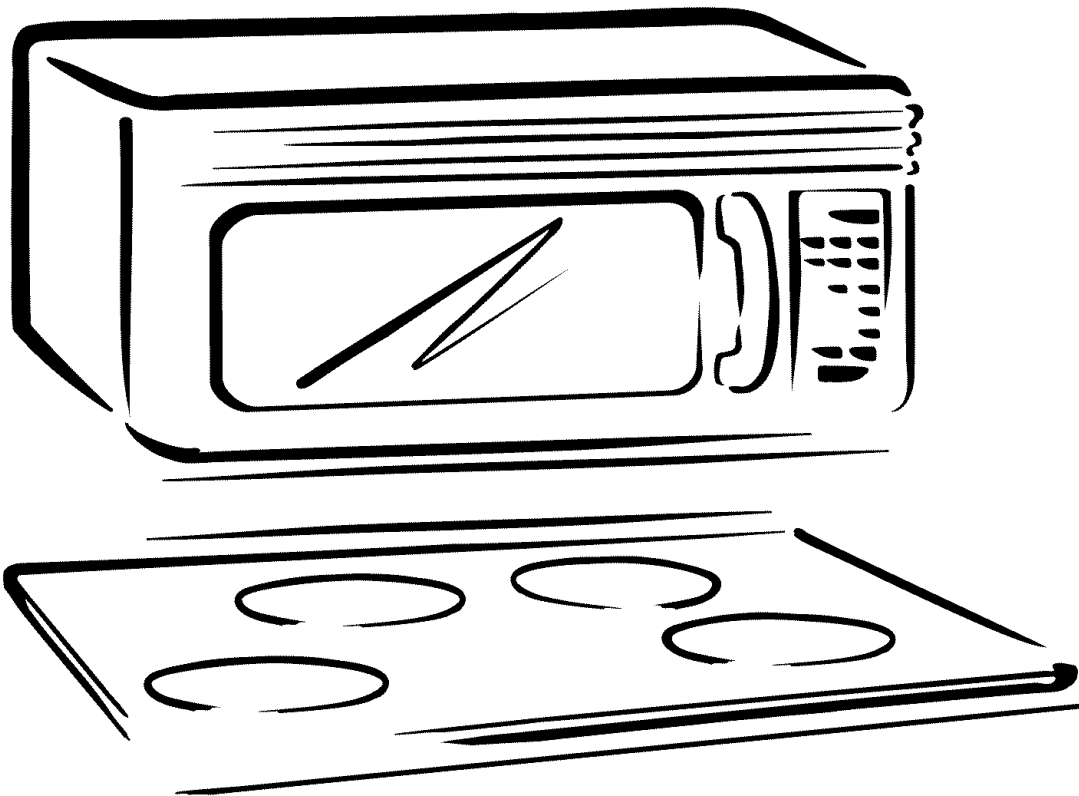

# Table of Contents

Warranty .....	2
Sears Service.....	3
Microwave Oven Safety .....	4
Getting to Know Your Microwave Oven .....	7
How your microwave oven works .....	7
Radio interference .....	7
For the best cooking results .....	7
Cookware guide .....	8
Operating safety precautions .....	8
Electrical connection .....	8
Specifications .....	9
Microwave oven features .....	9
Control panel features.....	10
<b>Using Your Microwave Oven .....</b>	<b>12</b>
Audible Signals .....	12
Interrupting Cooking.....	12
Clock .....	12
Child Lock .....	12
Turntable On/Off.....	13
Cooktop Light.....	13
Time Defrost .....	13
Exhaust Fan.....	13
Timed Cooking.....	14
Multi-stage Cooking .....	14
Microwave Power Levels .....	15
Auto Defrost .....	16
Operating Tips .....	16
Auto defrost table.....	17
Auto defrost table (Cont.).....	18
Defrosting tips .....	19
Using Quick Touch.....	20
Auto Cook .....	21
Cooking guide for Auto Cook .....	21
Auto Reheat .....	22
Cooking guide for Auto Reheat.....	22
<b>Caring for Your Microwave Oven .....</b>	<b>23</b>
Caring for the filters.....	24
Replacing the cooktop and oven lights .....	25
<b>Microwave Cooking Tips.....</b>	<b>26~27</b>
<b>Questions and Answers .....</b>	<b>28</b>
<b>Troubleshooting.....</b>	<b>29~30</b>
<b>Service .....</b>	<b>Back cover</b>

# Microwave Hood Combination Warranty

## One Year Limited Warranty

When installed, operated and maintained according to all instructions supplied with the product, if this appliance fails due to a defect in material or workmanship within one year from the date of purchase, call 1-800-4-MY-HOME® to arrange for free repair.

### This warranty covers only defects in material and workmanship. Sears will NOT pay for:

1. Expendable items that can wear out from normal use, including but not limited to filters, belts, light bulbs, and bags.
2. A service technician to instruct the user in correct product installation, operation or maintenance.
3. A service technician to clean or maintain this product.
4. Damage to or failure of this product if it is not installed, operated or maintained according to all instructions supplied with the product.
5. Damage to or failure of this product resulting from accident, abuse, misuse or use for other than its intended purpose.
6. Damage to or failure of this product caused by the use of detergents, cleaners, chemicals or utensils other than those recommended in all instructions supplied with the product.
7. Damage to or failure of parts or systems resulting from unauthorized modifications made to this product.

### Disclaimer of implied warranties; limitation of remedies

Customer's sole and exclusive remedy under this limited warranty shall be product repair as provided herein. Implied warranties, including warranties of merchantability or fitness for a particular purpose, are limited to one year or the shortest period allowed by law. Sears shall not be liable for incidental or consequential damages. Some states and provinces do not allow the exclusion or limitation of incidental or consequential damages, or limitations on the duration of implied warranties of merchantability or fitness, so these exclusions or limitations may not apply to you.

This warranty applies only while this appliance is used in the United States and Canada.

This warranty gives you specific legal rights, and you may also have other rights which vary from state to state.

Sears, Roebuck and Co., Dept. 817WA, Hoffman Estates, IL 60179  
Sears Canada Inc., Toronto, Ontario, Canada M5B 2B8

# Sears Service

## Master Protection Agreement

*Congratulations on making a smart purchase.*

Your new Kenmore® product is designed and manufactured for years of dependable operation. But like all products, it may require preventive maintenance or repair from time to time.

The Master Protection Agreement also helps extend the life of your new product. Here's what the Agreement\* includes:

- ✓ **Parts and labor** needed to help keep products operating properly **under normal use**, not just defects. Our coverage goes **well beyond the product warranty**. No deductibles, no functional failure excluded from coverage - **real protection**.
- ✓ **Expert service** by a force of more than **10,000 authorized Sears service technicians**, which means someone you can trust will be working on your product.
- ✓ **Unlimited service calls and nationwide service**, as often as you want us, whenever you want us.
- ✓ **"No-lemon" guarantee** - replacement of your covered product if four or more product failures occur within twelve months.
- ✓ **Product replacement** if your covered product can't be fixed.
- ✓ **Annual Preventive Maintenance Check** at your request - no extra charge.
- ✓ **Fast help by phone** - we call it **Rapid Resolution** - phone support from a Sears representative on all products. Think of us as a "talking owner's manual."
- ✓ **Power surge protection** against electrical damage due to power fluctuations.
- ✓ **\$250 Food Loss Protection** annually for any food spoilage that is the result of mechanical failure of any covered refrigerator or freezer.
- ✓ **Rental reimbursement** if repair of your covered product takes longer than promised.
- ✓ **10% discount** off the regular price of any non-covered repair service and related installed parts.

Once you purchase the Agreement, a simple phone call is all that it takes for you to schedule service. You can call anytime day or night, or schedule a service appointment online

The Master Protection Agreement is a risk free purchase. If you can-cel for any reason during the product warranty period, we will provide a full refund. Or, a prorated refund anytime after the product warranty period expires.

Purchase your Master Protection Agreement today!

**Some limitations and exclusions apply. For prices and additional information in the U.S.A. call 1-800-827-6655.**

**\* Coverage in Canada varies on some items. For full details call Sears Canada at 1-800-361-6665.**

### Sears Installation Service

**For Sears professional installation** of home appliances, garage door openers, water heaters, and other major home items, in the U.S.A. or Canada call **1-800-4-MY-HOME®**.

ENGLISH



# Microwave Oven Safety

## Your safety and the safety of others is very important.

We have provided many important safety messages in this manual and on your microwave oven. Always read and obey all safety messages.



This is the safety alert symbol.

This symbol alerts you to hazards that can kill or hurt you and others.

All safety messages will be preceded by the safety alert symbol and the word "DANGER" or "WARNING." These words mean:

 **DANGER**

You will be killed or seriously injured if you don't follow instructions immediately.

 **WARNING**

You can be killed or seriously injured if you don't follow instructions.

All safety messages will identify the hazard, tell you how to reduce the chance of injury, and tell you what can happen if the instructions are not followed.

## IMPORTANT SAFETY INSTRUCTIONS

When using electrical appliances, basic safety precautions should be followed, including the following:

**⚠️WARNING:** To reduce the risk of burns, electric shock, fire, injury to persons, or exposure to excessive microwave energy:

- Read all instructions before using the microwave oven.
- Read and follow the specific "PRECAUTIONS TO AVOID POSSIBLE EXPOSURE TO EXCESSIVE MICROWAVE ENERGY" found on page 6.
- The microwave oven must be grounded. Connect only to properly grounded outlet. See "GROUNDING INSTRUCTIONS" found on page 4,5 and 6.
- Install or locate the microwave oven only in accordance with the provided installation instructions.
- Some products such as whole eggs in the shell and sealed containers – for example, closed glass jars – are able to explode and should not be heated in the microwave oven.
- Use the microwave oven only for its intended use as described in this manual. Do not use corrosive chemicals or vapors in the microwave oven. This type of oven is specifically designed to heat, cook, or dry food. It is not designed for industrial or laboratory use.
- As with any appliance, close supervision is necessary when used by children.
- Do not operate the microwave oven if it has a damaged cord or plug, if it is not working properly, or if it has been damaged or dropped.

**SAVE THESE INSTRUCTIONS**

## IMPORTANT SAFETY INSTRUCTIONS

- The microwave oven should be serviced only by qualified service technician. Call an authorized service company for examination, repair, or adjustment.
- See door surface cleaning instructions in the “Caring for Your Microwave Oven” section.
- To reduce the risk of fire in the oven cavity:
  - Do not overcook food. Carefully attend the microwave oven when paper, plastic, or other combustible materials are placed inside the oven to facilitate cooking.
  - Remove wire twist-ties from paper or plastic bags before placing bags in oven.
  - If materials inside the oven ignite, keep oven door closed, turn oven off, and disconnect the power cord, or shut off power at the fuse or circuit breaker panel.
  - Do not use the cavity for storage purposes. Do not leave paper products, cooking utensils, or food in the cavity when not in use.
- Suitable for use above both gas and electric cooking equipment.
- Intended to be used above ranges with maximum width of 36 inches (91 cm).
- Clean Ventilating Hoods Frequently -Grease should not be allowed to accumulate on hood or filter.
- When flaming foods under the hood, turn the fan on.
- Use care when cleaning the vent-hood filter. Corrosive cleaning agents, such as lye-based oven cleaners, may damage the filter.
- Oversized foods or oversized metal utensils should not be inserted in the microwave oven as they may create a fire or risk of electric shock.
- Do not clean with metal scouring pads. Pieces can burn off the pad and touch electrical parts involving a risk of electric shock.
- Do not store anything directly on top of the microwave oven when the microwave oven is in operation.
- Do not cover or block any openings on the microwave oven.
- Do not store this microwave oven outdoors. Do not use the microwave oven near water - for example, near a kitchen sink, in a wet basement, near a swimming pool, or similar location.
- Do not immerse cord or plug in water.
- Keep cord away from heated surfaces.
- Do not let cord hang over edge of table or counter.
- Do not mount over a sink.
- Do not cover racks or any other part of the oven with metal foil. This will cause overheating of the oven.
- Liquids such as water, coffee, or tea are able to be overheated beyond the boiling point without appearing to be boiling due to surface tension of the liquid. Visible bubbling or boiling when the container is removed from the microwave oven is not always present. This could result in very hot liquids suddenly boiling over when a spoon or other utensil is inserted into the liquid. To reduce the risk of injury to persons;
  - 1) Do not overheat the liquid.
  - 2) Stir the liquid both before and halfway through heating it.
  - 3) Do not use straight-sided containers with narrow necks.
  - 4) After heating, allow the container to stand in the microwave oven for a short time before removing the container.
  - 5) Use extreme care when inserting utensils into the container.

**SAVE THESE INSTRUCTIONS**

**ENGLISH**

## PRECAUTIONS TO AVOID POSSIBLE EXPOSURE TO EXCESSIVE MICROWAVE ENERGY

- (a) Do not attempt to operate this oven with the door open since open-door operation can result in harmful exposure to microwave energy. It is important not to defeat or tamper with the safety interlocks.
- (b) Do not place any object between the oven front face and the door, or allow soil or cleaner residue to accumulate on sealing surfaces.
- (c) Do not operate the oven if it is damaged. It is particularly important that the oven door close properly and that there is no damage to the:
  - (1) Door (bent).
  - (2) Hinges and latches (broken or loosened).
  - (3) Door seals and sealing surfaces.
- (d) The oven should not be adjusted or repaired by anyone except properly qualified service technician.

## Electrical requirements

Observe all governing codes and ordinances. A 120-Volt, 60-Hz, AC-only, 15- or 20-amp fused electrical supply is required. (A time-delay fuse is recommended.) It is recommended that a separate circuit serving only this appliance be provided.

**⚠ DANGER**



**Electrical Shock Hazard**  
 Plug into a grounded 3 prong outlet. Do not remove ground prong. Do not use an adapter. Do not use an extension cord. Failure to follow these instructions can result in death, fire, or electrical shock.

## GROUNDING INSTRUCTIONS

• **For all cord connected appliances:** The microwave oven must be grounded. In the event of an electrical short circuit, grounding reduces the risk of electric shock by providing an escape wire for the electric current. The microwave oven is equipped with a cord having a grounding wire with a grounding plug. The plug must be plugged into an outlet that is properly installed and grounded.

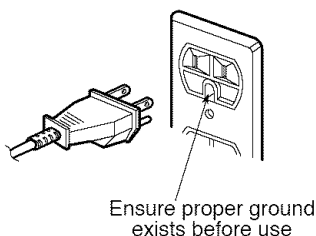

**⚠ WARNING:** Improper grounding can result in a risk of electric shock. Consult a qualified electrician or service technician if you do not understand the grounding instructions or if you wonder whether the appliance is properly grounded. Do not use an extension cord. If the power supply cord is too short, have a qualified electrician or service technician install an outlet near the microwave oven.

• **For a permanently connected appliance:** This appliance has a short power supply cord to reduce the risk of anyone tripping over or becoming entangled in the cord. The microwave oven must be connected to a grounded, metallic, permanent wiring system, or an equipment grounding conductor should be run with the circuit conductors and connected to the equipment grounding terminal or lead on the microwave oven.

**SAVE THESE INSTRUCTIONS**

# Getting to Know Your Microwave Oven

This section discusses the concepts behind microwave cooking. It also shows you the basics you need to know to operate your microwave oven. Please read this information before you use your oven.

## How your microwave oven works

**Microwave ovens are safe.** Microwave energy is not hot. It causes food to make its own heat, and it's this heat that cooks the food.

Microwaves are like TV waves, radio waves, or light waves. You cannot see them, but you can see what they do.

**A magnetron** in the microwave oven produces microwaves. The microwaves move into the oven where they contact food as it turns on the turntable.

**The glass turntable** of your microwave oven lets microwaves pass through. Then they bounce off a metal floor, back through the glass turntable, and are absorbed by the food.

**Microwaves** pass through most glass, paper, and plastics without heating them so food absorbs the energy. Microwaves bounce off metal containers so food does not absorb the energy.

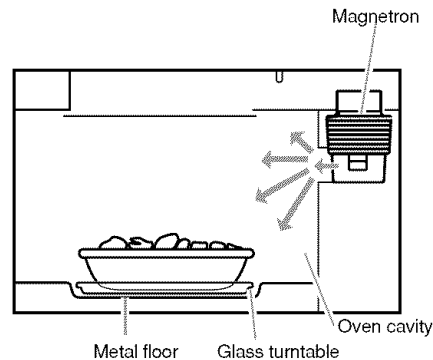

ENGLISH

## Radio interference

Using your microwave oven may cause interference to your radio, TV, or similar equipment. When there is interference, you can reduce it or remove it by:

- **Cleaning** the door and sealing surfaces of the oven.
- **Adjusting** the receiving antenna of the radio or television.
- **Moving** the receiver away from the microwave oven.
- **Plugging** the microwave oven into a different outlet so that the microwave oven and receiver are on different branch circuits.

## For the best cooking results

- **Always cook food** for the shortest cooking time recommended. Check to see how the food is cooking. If needed, touch Add Minute while the oven is operating or after the cooking cycle is over (see the "Using add minute" section).
- **Stir, turn over, or rearrange** the food being cooked about halfway through the cooking time for all recipes. This will help make sure the food is evenly cooked.
- **If you do not have a cover for a dish**, use wax paper, or microwave-approved paper towels or plastic wrap. Remember to turn back a corner of the plastic wrap to vent steam during cooking.

## Cookware guide

**Most heat resistant, nonmetallic cookware is safe for use in your microwave oven. However, to test cookware before using, follow these steps:**

1. Place the empty cookware in the microwave oven.
2. Measure 1 cup (250ml) water in a glass measuring cup and place it in the oven beside the cookware.
3. Microwave on 100% power for 1 minute. If the dish is warm, it should not be used for microwave cooking.

## Operating safety precautions

- **Never** lean on the door or allow a child to swing on it when the door is open.
- **Use hot pads.** Microwave energy does not heat containers, but the heat from the food can make the container hot.
- **Do not** use newspaper or other printed paper in the oven.
- **Do not** dry flowers, fruit, herbs, wood, paper, gourds, or clothes in the oven.
- **Do not** start a microwave oven when it is empty. Product life may be shortened. If you practice programming the oven, **put** a container of water in the oven. It is normal for the oven door to look wavy after the oven has been running for a while.
- **Do not** try to melt paraffin wax in the oven. Paraffin wax will not melt in a microwave oven because it allows microwaves to pass through it.
- **Do not** operate the microwave oven unless the glass turntable is securely in place and can rotate freely. The turntable can rotate in either direction. **Make sure** the turntable is correct-side up in the oven. **Handle your turntable with care** when removing it from the oven to avoid possibly breaking it. If your turntable cracks or breaks, contact your dealer for a replacement.
- **When you use a browning dish**, the browning dish bottom must be at least 3/16 inch above the turntable. Follow the directions supplied with the browning dish.
- **Never cook or reheat a whole egg inside the shell.** Steam buildup in whole eggs may cause them to burst, and possibly damage the oven. **Slice** hard-boiled eggs before heating. In rare cases, poached eggs have been known to explode. **Cover** poached eggs and **allow** a standing time of one minute before cutting into them.
- **For best results, stir any liquid several times during heating or reheating.** Liquids heated in certain containers (especially containers shaped like cylinders) may become overheated. The liquid may splash out with a loud noise during or after heating or when adding ingredients (coffee granules, tea bags, etc.). This can harm the oven.
- **Microwaves** may not reach the center of a roast. The heat spreads to the center from the outer, cooked areas just as in regular oven cooking. This is one of the reasons for letting some foods (for example, roasts or baked potatoes) stand for a while after cooking, or for stirring some foods during the cooking time.
- **Do not deep fry in the oven.** Microwavable utensils are not suitable and it is difficult to maintain appropriate deep-frying temperatures.
- **Do not overcook potatoes.** At the end of the recommended cooking time, potatoes should be slightly firm because they will continue cooking during standing time. **After microwaving, let** potatoes stand for 5 minutes. They will finish cooking while standing.

## Electrical connection

**If your electric power line or outlet voltage** is less than 110 volts, cooking times may be longer. Have a qualified electrician check your electrical system.

## Specifications

Power Supply	120V AC, 60 Hz
Rated Power Consumption	1500W
Microwave Output	*1000W
Rated Current	14.0A
Overall Dimensions(WxHxD)	29 15/16" x 16 7/16" x 15 3/8"
Oven Cavity Dimensions(WxHxD)	21 9/16" x 9 1/10" x 14 1/8"
Capacity of Oven Cavity	1.5 cu.ft

\*IEC 60705 RATING STANDARD

Specifications subject to change without prior notice.

## Microwave oven features

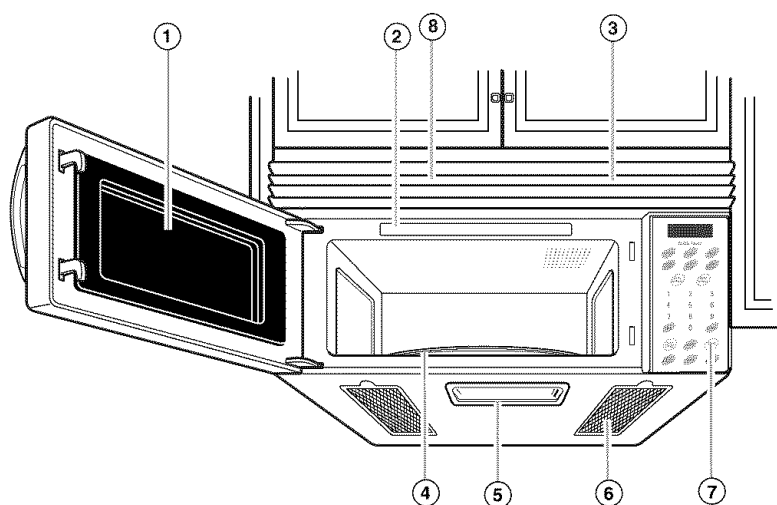

Your microwave oven is designed to make your cooking experience as enjoyable and productive as possible. To get you up and running quickly, the following is a list of the oven's basic features:

- 1. Metal Shielded Window** The shield prevents microwaves from escaping. It is designed as a screen to allow you to view food as it cooks.
- 2. Model and Serial Number Plate & Cooking Guide Label**

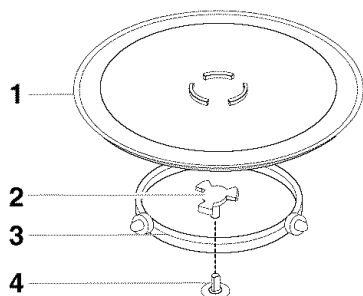

- 1. Turntable**
- 2. Hub**
- 3. Support**
- 4. Shaft**

### 3. Vent Grille

**4. Turntable.** The turntable turns food as it cooks for more even cooking. It must be in the oven during operation for best cooking results.

### 5. Cooktop Light

**6. Grease Filters.** See "Caring for the filters" section.

**7. Control Panel.** Touch the pads on this panel to perform all functions.

**8. Charcoal Filter** (behind Vent Grille)

The turntable rotates in both directions to help cook food more evenly. Do not operate the microwave oven without the turntable in place.

### To Install:

1. Place the support on the oven cavity bottom.
2. Place the turntable on the support.

Fit the raised, curved lines in the center of the turntable bottom between the three spokes of the hub.

The rollers on the support should fit inside the turntable bottom ridge.

## Control panel features

Your microwave oven control panel lets you select the desired cooking function quickly and easily. All you have to do is touch the necessary Command Pad. The following is a list of all the Command and Number Pads located on the control panel. **For more information on these features, see “Using your microwave oven” section.**

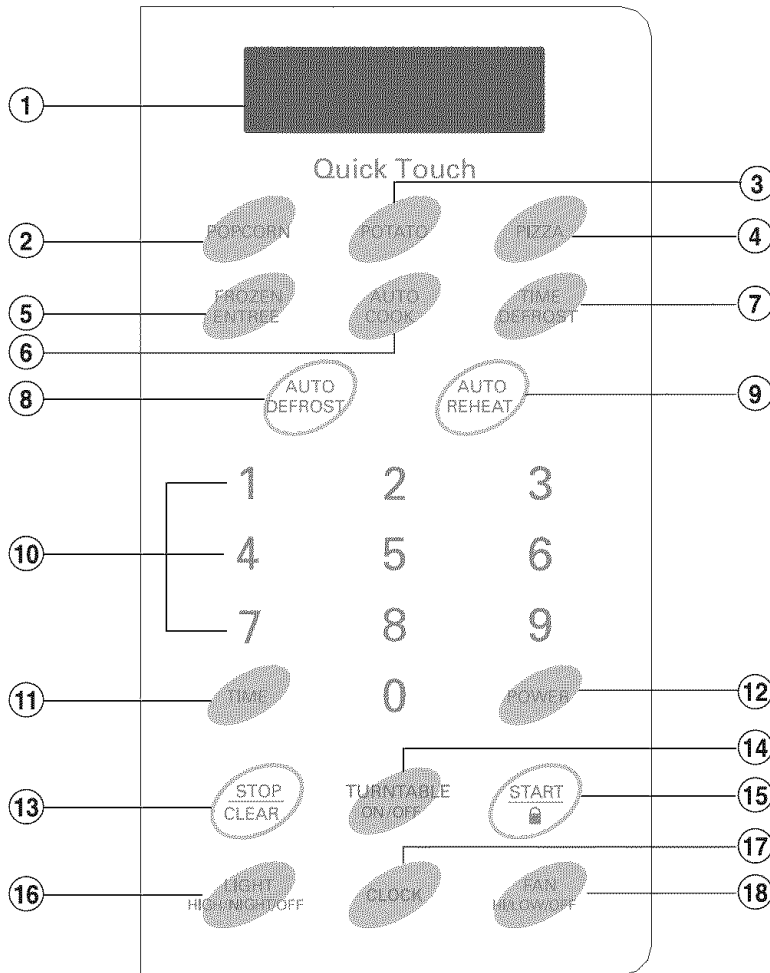

**1. Display.** The display includes a clock and indicators to tell you time of day, cooking time settings, cook powers, quantities, weights and cooking functions selected.

**2. POPCORN.** Touch this pad to pop one of 2 bag sizes of popcorn without entering a cook time or power.

3. **POTATO.** Touch this pad to cook up to 4 potatoes without entering a cook time or power.
  4. **PIZZA.** Touch this pad to reheat one or several slices of pizza without entering a cook time or power.
  5. **FROZEN ENTREE.** Touch this pad to cook a 10 - to 20 - ounce (284 to 567 g) frozen entree without entering a cook time or power.
  6. **AUTO COOK.** Touch this pad to cook microwavable foods without entering a cook time or power.
  7. **TIME DEFROST.** Touch this pad to set a defrost time.
  8. **AUTO DEFROST.** Touch this pad followed by number pads to thaw frozen meat by weight.
  9. **AUTO REHEAT.** Touch this pad to reheat microwavable foods without entering a cook time or power.
  10. **Number Pads.** Touch number pads to enter cooking times, cook powers, quantities, weights, or food categories.
  11. **TIME.** Touch this pad followed by number pads to set a cooking time.
  12. **POWER.** Touch this pad after the cook time has been set, followed by a Number Pad to set the amount of microwave energy released to cook the food. The higher the number, the higher the microwave power or "cooking speed."
  13. **STOP/CLEAR.** Touch this pad to erase an incorrect command, cancel a program during cooking, or to clear the Display.
  14. **TURNTABLE ON/OFF.** Touch this pad to turn off the turntable. "OFF" will appear in the display.
  15. **START.** Touch this pad to start a function. If you open the door after the oven begins to cook, retouch START.
  16. **LIGHT.** Touch this pad to turn the light on high, night(low), or off.
  17. **CLOCK.** Touch this pad to enter the correct time of day.
  18. **FAN.** Touch this pad to turn the fan on high, low, or off.
- NOTE: If you try to enter incorrect instructions, you will not hear any tones. Touch STOP/Clear and re-enter the instructions.**





## TURNTABLE ON/OFF

For best cooking results, leave the turntable on. It can be turned off for large dishes.

**Touch:** **Display Shows:**

1.  : **OFF**

2.  : **ON**

Press **Turntable On/Off** to turn the turntable on or off.

**NOTE:** Sometimes the turntable can become hot to touch. Be careful touching the turntable during and after cooking.

Do not run the oven empty without food in it.

## COOKTOP LIGHT

The pad on the bottom right of the control panel controls the cooktop light.

**Example:** To set the Lamp for HIGH.

**Touch:** **Display Shows:**

1.  :

once for HIGH light  
twice for NIGHT light

2.  :

To turn off, touch pad one or two times depending on light setting.

## EXHAUST FAN

The pad on the bottom center of the control panel controls the 2-speed exhaust fan.

**Example:** To set the exhaust fan speed

**Touch:** **Display Shows:**

1.  :

Once for HIGH  
Twice for Low

2.  :

Turn off fan when desired

**NOTE:** If the temperature from the range or cooktop below the oven gets too hot, the exhaust fan in the vent hood will automatically turn on at the HIGH setting to protect the oven.

It may stay on up to an hour to cool the oven.

When this occurs, the FAN pad will not turn the fan off. You cannot turn the exhaust fan off during microwave cooking.

## TIME DEFROST

Using TIME DEFROST can defrost for a selected length of time.

**Example:** To set TIME DEFROST for 2 minutes.

**Touch:** **Display Shows:**

1.  : 0

2. 2 0 0

2:00

3. 

Time counting down.



At the end of the Time defrost four tones will sound.

## TIMED COOKING

This feature lets you program a specific cook time and power. For best results, there are 10 power level settings in addition to HIGH (100%) power. Refer to the "Microwave Power Levels Table" on page 15 for more information.

**NOTE:** If you do not select a power level, the oven will automatically cook at HIGH (100%) power.

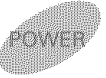



**Example: To cook for 5 minutes, 30 seconds at 80% power.**

Touch:	Display Shows:
1. 	: 0
2. 5 3 0	5 : 30
3. 	P-HI
4. 8	P-80
5. 	Time counting down and <b>COOK</b> .

## MULTI-STAGE COOKING

For best results, some recipes call for different cook powers during different stages of a cook cycle. You can program your oven to switch from one power level to another for up to 2 stages.

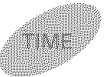
**Example: To set a 2-stage cook cycle.**

Touch:	Display Shows:
1. 	: 0
2. 3 0 0 to set a 3 minute cook time for first stage.	3 : 00
3. 	P-HI
4. 8 to set an 80% cook power for the first stage.	P-80
5. 	: 0
6. 7 0 0 to set a 7 minute cook time for second stage.	7 : 00
7. 	P-HI
8. 5 to set a 50% cook power for the second stage.	P-50
9. 	Time counting down and <b>COOK</b> .
10. When the first stage is over, you will hear two short tones as the oven begins the second cook stage.	

## MICROWAVE POWER LEVELS

For best results, some recipes call for different cook powers. The lower the cook power, the slower the cooking. Each number from 1 to 9 stands for a different percentage of full cook power.

The following chart gives the percentage of cook power each number pad stands for, and the cook power name usually used.

It also tells you when to use each cook power. Follow recipe or food package instructions if available.

**NOTE:** Refer to a reliable cookbook for cooking times based on the 1000 Watt cook power of your microwave oven.

COOK Power	NAME	WHEN TO USE IT
100% of full power	High	<ul style="list-style-type: none"> <li>• Quick heating many convenience foods and foods with high water content, such as soups and beverages.</li> <li>• Cooking tender cuts of meat, ground meat,</li> </ul>
9 = 90% of full power		<ul style="list-style-type: none"> <li>• Heating cream soups</li> </ul>
8 = 80% of full power		<ul style="list-style-type: none"> <li>• Heating rice, pasta, or casseroles</li> </ul>
7 = 70% of full power	Medium-High	<ul style="list-style-type: none"> <li>• Cooking and heating foods that need a Cook Power lower than high (for example, whole fish and meat loaf) or when food is cooking too fast</li> <li>• Reheating a single serving of food</li> </ul>
6 = 60% of full power		<ul style="list-style-type: none"> <li>• Cooking requiring special care, such as cheese and egg dishes, pudding, and custards</li> <li>• Finishing cooking casseroles</li> </ul>
5 = 50% of full power	Medium	<ul style="list-style-type: none"> <li>• Cooking ham, whole poultry, and pot roasts</li> <li>• Simmering stews</li> </ul>
4 = 40% of full power		<ul style="list-style-type: none"> <li>• Melting chocolate</li> <li>• Heating pastries</li> </ul>
3 = 30% of full power	Medium-Low, Defrost	<ul style="list-style-type: none"> <li>• Manually defrosting foods, such as bread, fish, meats, poultry, and precooked foods</li> </ul>
2 = 20% of full power		<ul style="list-style-type: none"> <li>• Softening butter, cheese, and ice cream</li> </ul>
1 = 10% of full power	Low	<ul style="list-style-type: none"> <li>• Keeping food warm</li> <li>• Taking chill out of fruit</li> </ul>

ENGLISH

**NOTE:** Once cook time has been entered, you can also use the Cook Power pad as a second Kitchen Timer by entering "0" for the Cook Power. The oven will count down the cooking time you set without cooking.

## AUTO DEFROST



Three defrost sequences are preset in the oven. The auto defrost feature provides you with the best defrosting method for frozen foods. The cooking guide will show you which defrost sequence is recommended for the food you are defrosting.

For added convenience, the Auto Defrost includes a built-in beep mechanism that reminds you to check, turn over, separate, or rearrange to get best defrost results. Three different defrosting levels are provided.

- 1 MEAT
- 2 POULTRY
- 3 FISH

\*Available weight is 0.1~6.0 lbs.

**Example: To defrost 1.2 lbs of ground beef.**

Touch:	Display Shows:
1. 	<i>dEF1</i>
2. 1	<i>0.1</i>
3. 1 and 2 to enter the weight	<i>1.2</i>
4. 	Time counting down.

**NOTE:**

When you touch the START pad, the display changes to defrost time count down. The oven will beep during the DEFROST cycle. At this time, open the door and turn, separate, or rearrange the food. Remove any portions that have thawed. Return frozen portions to the oven and touch START to resume the defrost cycle.

## OPERATING TIPS

- For best results, remove fish, shellfish, meat, and poultry from its original closed paper or plastic package (wrapper). Otherwise, the wrap will hold steam and juice close to the foods, which can cause the outer surface of the foods to cook.
- For best results, shape your ground meat into the form of a doughnut before freezing. When defrosting, scrape off thawed meat when the beep sounds and continue defrosting.
- Place foods in a shallow container or on a microwave roasting rack to catch drippings.

This table shows you food type selections and the weights you can set for each type. For best results, loosen or remove covering on food.

FOOD	TOUCH Auto Defrost	WEIGHTS YOU CAN SET (tenths of a pound)
Meat	1 Time(s)	.1 to 6.0 (45g to 2722g)
Poultry	2 Time(s)	.1 to 6.0 (45g to 2722g)
Fish	3 Time(s)	.1 to 6.0 (45g to 2722g)

## Weight conversion table

You are probably used to food weights as being in pounds and ounces that are fractions of a pound (for example, 4 ounces equals 1/4 pound). However, in order to enter food weight in Auto Defrost, you must specify pounds and tenths of a pound.

If the weight on the food package is in fractions of a pound, you can use the following table to convert the weight to decimals.

Equivalent Weight		
OUNCES	DECIMAL WEIGHT	
1.6	.10	
3.2	.20	
4.0	.25	One-Quarter Pound
4.8	.30	
6.4	.40	
8.0	.50	One-Half Pound
9.6	.60	
11.2	.70	
12.0	.75	Three-Quarters Pound
12.8	.80	
14.4	.90	
16.0	1.00	One Pound

**AUTO DEFROST TABLE**

**Meat setting**

FOOD	SETTING	AT BEEP	SPECIAL INSTRUCTIONS
<b>BEEF</b>			Meat of irregular shape and large, fatty cuts of meat should have the narrow or fatty areas shielded with foil at the beginning of a defrost sequence.
Ground Beef, Bulk	MEAT	Remove thawed portions with fork. Turn over. Return remainder to oven.	Do not defrost less than 1/4 lb. Freeze in doughnut shape.
Ground Beef, Patties	MEAT	Separate and rearrange.	Do not defrost less than 2 oz. patties. Depress center when freezing.
Round Steak	MEAT	Turn over. Cover warm areas with aluminum foil.	Place on a microwavable roasting rack.
Tenderloin Steak	MEAT	Turn over. Cover warm areas with aluminum foil.	Place on a microwavable roasting rack.
Stew Beef	MEAT	Remove thawed portions with fork. Separate remainder. Return remainder to oven.	Place in a microwavable baking dish.
Pot Roast, Chuck Roast	MEAT	Turn over. Cover warm areas with aluminum foil.	Place on a microwavable roasting rack.
Rib Roast	MEAT	Turn over. Cover warm areas with aluminum foil.	Place on a microwavable roasting rack.
Rolled Rump Roast	MEAT	Turn over. Cover warm areas with aluminum foil.	Place on a microwavable roasting rack.
<b>LAMB</b>			
Cubes for Stew	MEAT	Remove thawed portions with fork. Return remainder to oven.	Place in a microwavable baking dish.
Chops (1 inch thick)	MEAT	Separate and rearrange.	Place on a microwavable roasting rack.
<b>PORK</b>			
Chops (1/2 inch thick)	MEAT	Separate and rearrange.	Place on a microwavable roasting rack.
Hot Dogs	MEAT	Separate and rearrange.	Place on a microwavable roasting rack.
Spareribs Country-style Ribs	MEAT	Turn over. Cover warm areas with aluminum foil.	Place on a microwavable roasting rack.
Sausage, Links	MEAT	Separate and rearrange.	Place on a microwavable roasting rack.
Sausage, Bulk	MEAT	Remove thawed portions with fork. Turn over. Return remainder to oven.	Place in a microwavable baking dish.
Loin Roast, Boneless	MEAT	Turn over. Cover warm areas with aluminum foil.	Place on a microwavable roasting rack.

**ENGLISH**

**AUTO DEFROST TABLE (CONT.)**

**Poultry setting**

FOOD	SETTING	AT BEEP	SPECIAL INSTRUCTIONS
<b>CHICKEN</b> Whole (up to 6 lbs)	POULTRY	Turn over (finish defrosting breast-side down). Cover warm areas with aluminum foil.	Place chicken breast-side up on a microwavable roast rack. Finish defrosting by immersing in cold water. Remove giblets when chicken is partially defrosted.
Cut-up		Separate pieces and rearrange.  Turn over. Cover warm areas with aluminum foil.	Place on a microwavable roasting rack.  Finish defrosting by immersing in cold water.
<b>CORNISH HENS</b> Whole	POULTRY	Turn over. Cover warm areas with aluminum foil.	Place on a microwavable roasting rack. Finish defrosting by immersing in cold water.
<b>TURKEY</b> Breast (up to 6 lbs)	POULTRY	Turn over. Cover warm areas with aluminum foil.	Place on a microwavable roasting rack. Finish defrosting by immersing in cold water.

**Fish setting**

FOOD	SETTING	AT BEEP	SPECIAL INSTRUCTIONS
<b>FISH</b> Fillets	FISH	Turn over. Separate fillets when partially thawed if possible.	Place in a microwavable baking dish. Carefully separate fillets under cold water.
Steaks	FISH	Separate and rearrange.	Place in a microwavable baking dish. Run cold water over to finish defrosting.
Whole	FISH	Turn over.	Place in a microwavable baking dish. Cover head and tail with foil; do not let foil touch sides of microwave. Finish defrosting by immersing in cold water.
<b>SHELLFISH</b> Crabmeat	FISH	Break apart. Turn over.	Place in a microwavable baking dish.
Lobster tails	FISH	Turn over and rearrange.	Place in a microwavable baking dish.
Shrimp	FISH	Separate and rearrange.	Place in a microwavable baking dish.
Scallops	FISH	Separate and rearrange.	Place in a microwavable baking dish.

## DEFROSTING TIPS

- **When using** Auto Defrost, the weight to be entered is the net weight in pounds and tenths of pounds (the weight of the food minus the container).
- **Before starting**, make sure you have removed any of the metal twist-ties which often come with frozen food bags, and replace them with strings or elastic bands.
- **Open containers** such as cartons before they are placed in the oven.
- **Always slit** or pierce plastic pouches or packaging.
- **If food is foil wrapped**, remove foil and place it in a suitable container.
- **Slit** the skins, if any, of frozen food such as sausage.
- **Bend** plastic pouches of food to ensure even defrosting.
- **Always underestimate** defrosting time. If defrosted food is still icy in the center, return it to the microwave oven for more defrosting.
- **The length** of defrosting time varies according to how solidly the food is frozen.
- **The shape of the package** affects how quickly food will defrost. Shallow packages will defrost more quickly than a deep block.
- **As food begins to defrost**, separate the pieces. Separated pieces defrost more easily.
- **Use small pieces of aluminum foil** to shield parts of food such as chicken wings, leg tips, fish tails, or areas that start to get warm. Make sure the foil does not touch the sides, top, or bottom of the oven. The foil can damage the oven lining.
- **For better results**, let food stand after defrosting. (For more information on standing time, see the "Microwave Cooking Tips" section.)
- **Turn over** food during defrosting or standing time. Break apart and remove food as required.



# Using Quick Touch

Your oven's menu has been preprogrammed to cook food automatically. Tell the oven what you want. Then let your microwave oven cook your selections.

## POPCORN

Popcorn lets you pop 3.0, and 3.5 ounce bags of commercially packaged microwave popcorn. Pop only one package at a time. If you are using a microwave popcorn popper, follow manufacturer's instructions. To set your microwave oven correctly, follow this chart:

**Example: To pop a 3.0 oz. bag.**

**Touch:**                      **Display Shows:**



3.0

once for 3.5 oz  
twice for 3.0 oz

Time counting down and  
**COOK.**

When the cook time is over,  
you will hear four beeps and **End** will display.

## PIZZA

Pizza lets you reheat up to 3 slices of pizza. A slice is based on a 5 ounce slice.

**NOTE:**

- Place on a low plate & paper towel.
- Do not cover.

**Example: To reheat 2 slices of Pizza.**

**Touch:**                      **Display Shows:**



2

once for 1 slice  
twice for 2 slices  
three times for 3 slices

Time counting down and  
**COOK.**

When the cook time is over,  
you will hear four beeps and **End** will display.

## FROZEN ENTREE

Frozen Entree lets you cook 10 and 20 ounce plates of commercially packaged microwave frozen entree without entering cooking times and power levels.

Remove tray from outer carton.

Do not remove film cover, but cut it to vent.

**Example: To reheat a 20 oz. frozen entree.**

**Touch:**                      **Display Shows:**



20

once for 10 oz  
twice for 20 oz

Time counting down and  
**COOK.**

When the cook time is over,  
you will hear four beeps and **End** will display.

## POTATO

The Potato lets you cook potatoes with preset times and cook powers. You can choose from 1 to 4 potatoes.

**NOTE:**

- Cooking times are based on an average 8 ounce potato.
- Before baking, pierce potato with fork several times.
- After baking, let stand for 5 minutes.

**Example: To cook 2 Potatoes.**

**Touch:**                      **Display Shows:**



2

once for 1 potato  
twice for 2 potatoes  
three times for 3 potatoes  
four times for 4 potatoes

Time counting down and  
**COOK.**

When the cook time is over,  
you will hear four beeps and **End** will display.

## AUTO COOK

Auto Cook provides four preset categories for cooking.

**Example: To cook 2 cups of Casserole.**

**Touch:** **Display Shows:**

1.  *AC-4*

Choose food category.

Category	Touch pad of Time(s)
Fresh vegetable	1
Frozen vegetable	2
Rice	3
Casserole	4

**Touch:** **Display Shows:**

2. **2** Time counting down and **COOK**.

Enter quantity/servings.

Category	Number of cups
Fresh vegetable	1 - 4 cups
Frozen vegetable	1 - 4 cups
Rice	1 - 2 cups
Casserole	1 - 4 cups

When the cook time is over, you will hear four beeps and **End** will display.

**ENGLISH**

## COOKING GUIDE FOR AUTO COOK

CODE	CATEGORY	QUANTITY	DIRECTIONS
1	FRESH VEGETABLE	1 cup	Place in a microwavable bowl or casserole. Add water according to the quantity. Cover with plastic wrap and vent. Let stand 3 minutes. * 1-2 cups: add 2 tbsp water. * 3-4 cups: add 2 tbsp water.
		2 cups	
		3 cups	
		4 cups	
2	FROZEN VEGETABLE	1 cup	Place in a microwavable bowl or casserole. Cover with plastic wrap and vent. Let stand 3 minutes. * 1-2 cups: add 2 tbsp water. * 3-4 cups: add 2 tbsp water.
		2 cups	
		3 cups	
		4 cups	
3	RICE	1 cup	Place in a microwavable bowl or casserole. Cover with plastic wrap and vent. Let stand 5 minutes.
		2 cups	
4	CASSEROLE	1 cup	Place in a microwavable bowl or casserole. Cover with plastic wrap and vent. Stir and let stand 3 minutes.
		2 cups	
		3 cups	
		4 cups	

## AUTO REHEAT

Auto Reheat provides four preset categories for reheating.

**Example: To reheat 2 servings of Dinner plate.**

**Touch:** **Display Shows:**

1.  rH-1

Choose food category.

Category	Touch pad of Time(s)
Dinner plate	1
Soup/sauce	2
Casserole	3
Roll/Muffin	4

**Touch:** **Display Shows:**

2. 2

Time counting down and **COOK.**

Enter quantity/servings.

Category	Number of cups/Items
Dinner plate	1-2 servings
Soup/sauce	1-4 cups
Casserole	1-4 cups
Roll/Muffin	1-4 pieces

When the cook time is over, you will hear four beeps and **End** will display.

## COOKING GUIDE FOR AUTO REHEAT

CODE	CATEGORY	SERVING AMOUNT	DIRECTION
1	DINNER PLATE	1 serving (10 oz.)	Place on a low plate. Cover with vented plastic wrap. Let stand 3 minutes.
		2 servings (15 oz.)	
2	SOUP/SAUCE	1 cup	Place in shallow microwavable casserole. Cover with vented plastic wrap. Stir and let stand 3 minutes.
		2 cups	
		3 cups	
		4 cups	
3	CASSEROLE	1 cup	Place in a microwavable bowl or casserole. Cover with plastic wrap. Stir and let stand 3 minutes.
		2 cups	
		3 cups	
		4 cups	
4	ROLL/MUFFIN	1 piece (2 oz.)	Place on paper towel. Do not cover.
		2 pieces (4 oz.)	
		3 pieces (6 oz.)	
		4 pieces (8 oz.)	

# Caring for Your Microwave Oven

To make sure your microwave oven looks good and works well for a long time, you should maintain it properly. For proper care, please follow these instructions carefully.

**For interior surfaces:** Wash often with warm, sudsy water and a sponge or soft cloth.

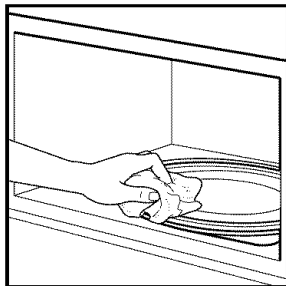

**Use** only mild, nonabrasive soaps or a mild detergent. **Be sure to keep the areas clean where the door and oven frame touch when closed.** Wipe well with clean cloth.

Over time, stains can occur on the surfaces as the result of food particles spattering during cooking. This is normal.

For stubborn soil, boil a cup of water in the oven for 2 to 3 minutes. Steam will soften the soil. To get rid of odors inside the oven, boil a cup of water with some lemon juice or vinegar in it.

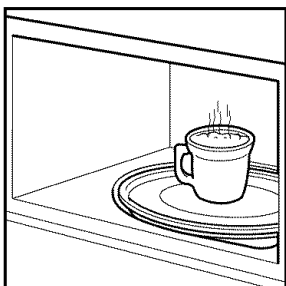

**To clean turntable and turntable support,** wash in

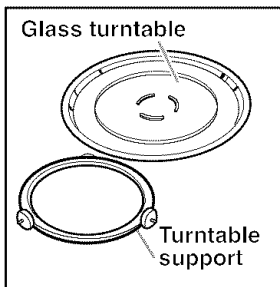

mild, sudsy water; for heavily soiled areas **use** a mild cleanser and scouring sponge. The turntable and turntable support are dishwasher safe.

**For exterior surfaces and control panel:** Use a soft

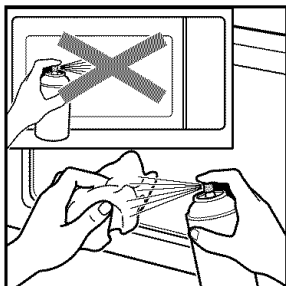

cloth with spray glass cleaner. Apply the spray glass cleaner to the soft cloth; do not spray directly on the oven.

**NOTE: Abrasive cleansers, steel wool pads, gritty wash cloths, some paper towels, etc., can dam-**

age the control panel and the interior and exterior oven surfaces.

ENGLISH

## CARING FOR THE FILTERS

The grease filters should be removed and cleaned often, at least once a month.

### Grease filters (Part No. 5230W1A012A):

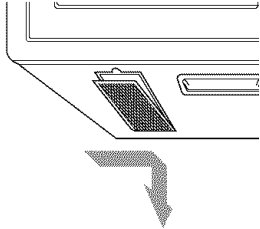

1. Unplug microwave oven or disconnect power.
2. To remove grease filters, slide each filter to the side. Pull filters downward and push to the other side. The filter will drop out.

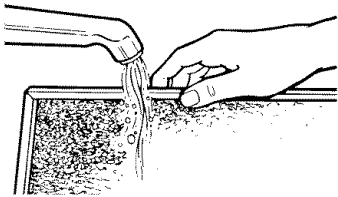

3. Soak grease filters in hot water and a mild detergent. Scrub and swish to remove embedded dirt and grease. Rinse well and shake to dry. Do not clean filters with ammonia, corrosive cleaning agents such as lye-based oven cleaners, or place them in a dishwasher. The filters will turn black or could be damaged.

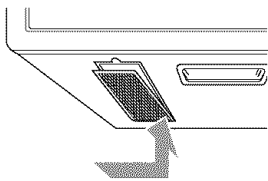

4. To replace grease filters, slide filter in the frame slot on one side of the opening. Push filter upward and push to the other side to lock into place.
5. Plug in microwave oven or reconnect power.

## REPLACING THE COOKTOP AND OVEN LIGHTS

### The cooktop light

1. Unplug microwave oven or disconnect power.

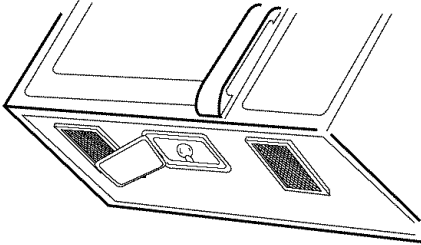

2. Remove the bulb cover mounting screws.

3. Replace bulb with candelabra-base 30-watt bulb (Part No. 6912W3Q001A) available from Sears by calling 1-800-4-MY-HOME®

4. Plug in microwave oven or reconnect power.

### The oven light

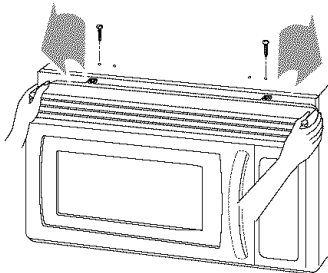

1. Unplug microwave oven or disconnect power.

2. Remove the vent grille mounting screws.

3. Tip the grille forward, then lift out to remove.

Bulb holder

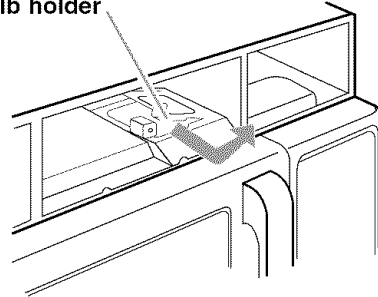

4. Lift up the bulb holder.

5. Replace the bulb with a candelabra-base 30-watt bulb (Part No. 6912W3Q001A) available from Sears by calling 1-800-4-MY-HOME®

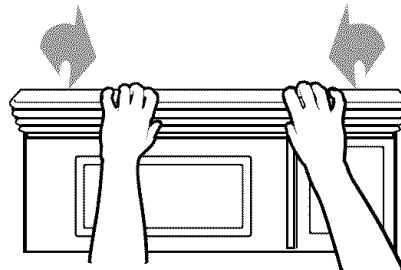

6. Slide the top of the vent grille into place. Push the bottom until it snaps into place. Replace the mounting screws.

7. Plug in microwave oven or reconnect power.

ENGLISH

## MICROWAVE COOKING TIPS

### Amount of food

- **If you increase or decrease** the amount of food you prepare, the time it takes to cook that food will also change. For example, if you double a recipe, add a little more than half the original cooking time. Check for doneness and, if necessary, add more time in small increments.

### Starting temperature of food

- **The lower the temperature** of the food being put into the microwave oven, the longer it takes to cook. Food at room temperature will be re-heated more quickly than food at refrigerator temperature.

### Composition of food

- **Food with a lot of fat and sugar** will be heated faster than food containing a lot of water. Fat and sugar will also reach a higher temperature than water in the cooking process.
- **The more dense the food**, the longer it takes to heat. "Very dense" food like meat takes longer to heat than lighter, more porous food like sponge cakes.

### Size and shape

- **Smaller pieces of food** will cook faster than larger pieces. Also, same shaped pieces cook more evenly than different-shaped pieces.
- **With foods that have different thicknesses**, the thinner parts will cook faster than the thicker parts. **Place** the thinner parts of chicken wings and legs in the center of the dish.

### Stirring, turning foods

- **Stirring and turning foods** spreads heat quickly to the center of the dish and avoids overcooking at the outer edges of the food.

### Covering food

Cover food to:

- **Reduce** splattering
- **Shorten** cooking times
- **Keep** food moist

You can use any covering that lets microwaves pass through. See "Getting to Know Your Microwave Oven" for materials that microwaves will pass through.

### Releasing pressure in foods

- **Several foods** (for example: baked potatoes, sausages, egg yolks, and some fruits) are tightly covered by a skin or membrane. Steam can build up under the membrane during cooking, causing the food to burst. To relieve the pressure and to prevent bursting, **pierce** these foods before cooking with a fork, cocktail pick, or toothpick.

### Using standing time

- **Always allow food to stand** after cooking. Standing time after defrosting and cooking allows the temperature to evenly spread throughout the food, improving the cooking results.
- **The length of the standing time** depends on how much food you are cooking and how dense it is. Sometimes it can be as short as the time it takes you to remove the food from the oven and take it to the serving table. However, with larger, denser food, the standing time may be as long as 10 minutes.

### Arranging food

For best results, place food evenly on the plate. You can do this in several ways:

- **If you are cooking several items of the same food**, such as baked potatoes, **place** them in a ring pattern for uniform cooking.
- **When cooking foods of uneven shapes or thickness, such as chicken breasts**, **place** the smaller or thinner area of the food towards the center of the dish where it will be heated last.
- **Layer thin slices of meat** on top of each other.
- **When you cook or reheat whole fish**, **score** the skin – this prevents cracking.
- **Do not** let food or a container touch the top or sides of the oven. This will prevent possible arcing.

### Using aluminum foil

Metal containers should not be used in a microwave oven. There are, however, some exceptions. If you have purchased food which is prepackaged in an aluminum foil container, refer to the instructions on the package. When using aluminum foil containers, cooking times may be longer because microwaves will only penetrate the top of the food. If you use aluminum containers without package instructions, follow these guidelines:

## MICROWAVE COOKING TIPS (CONT.)

### Using aluminum foil (cont.)

- **Place** the container in a glass bowl and add some water so that it covers the bottom of the container, not more than 1/4 in. (.64 cm) high. This ensures even heating of the container bottom.
- **Always remove** the lid to avoid damage to the oven.
- **Use only** undamaged containers.
- **Do not use** containers taller than 3/4 in. (1.9 cm).
- **Container must be** at least half filled.
- **To avoid arcing**, there must be a minimum 1/4 in. (.64 cm) between the aluminum container and the walls of the oven and also between two aluminum containers.
- **Always place** the container on the turntable.
- **Shield** with small pieces of aluminum foil, parts of food that may cook quickly, such as wing tips and leg ends of poultry.
- **Heating food** in aluminum foil containers usually takes up to double the time compared to reheating in plastic, glass, china, or paper containers.  
The time when food is ready will vary depending upon the type of container you use.
- **Let food stand** for 2 to 3 minutes after heating so that heat is spread evenly throughout container.

### Cooking you should not do in your microwave oven

- **Do not** do canning of foods in the oven. Closed glass jars may explode, resulting in damage to the oven.
- **Do not** use the microwave oven to sterilize objects (baby bottles, etc.). It is difficult to keep the oven at the high temperature needed for sterilization.



# Questions and Answers

QUESTIONS	ANSWERS
Can I operate my microwave oven without the turntable or turn the turntable over to hold a large dish?	No. If you remove or turn over the turntable, you will get poor cooking results. Dishes used in your oven must fit on the turntable.
Can I use either metal or aluminum pans in my microwave oven?	You can use aluminum foil for shielding (use small, flat pieces), small skewers, and shallow foil trays (if tray is not taller than 3/4 in. [1.9 cm] deep and is filled with food to absorb microwave energy). Never allow metal to touch walls or door.
Is it normal for the turntable to turn in either direction?	Yes. The turntable rotates clockwise or counter-clockwise, depending on the rotation of the motor when the cooking cycle begins.
Sometimes the door of my microwave oven appears wavy. Is this normal?	This appearance is normal and does not affect the operation of your oven.
What are the humming noises that I hear when my microwave oven is operating?	You may hear the sound of the transformer when the magnetron tube cycles on.
Why does the dish become hot when I microwave food in it? I thought that this should not happen.	As the food becomes hot it will conduct the heat to the dish. Be prepared to use hot pads to remove food after cooking.
What does "standing time" mean?	"Standing time" means that food should be removed from the oven and covered for additional time to allow it to finish cooking. This frees the oven for other cooking.
Why does steam come out of the air exhaust vent?	Steam is normally produced during cooking. The microwave oven has been designed to vent this steam out the vents.
Can I pop popcorn in my microwave oven? How do I get the best results?	Yes. Pop packaged microwave popcorn following manufacturer's guidelines. Do not use regular paper bags. Do not repop unpopped kernels. Do not pop popcorn in glass cookware.

# Troubleshooting

Most cooking problems often are caused by little things you can find and fix without tools of any kind. Check the lists below and on the next page before calling for assistance or service. If you still need help, call Sears Service at 1-800-4-MY-HOME®

## MICROWAVE OVEN DOES NOT WORK

PROBLEM	CAUSE
Nothing works.	<ul style="list-style-type: none"><li>• The power supply cord is not plugged into a grounded 3 prong outlet. (See the Electrical Requirements" section on page 6 and the "Electrical connection" section on Page 8.)</li><li>• A household fuse has blown or a circuit breaker has tripped.</li><li>• The electric company has had a power failure.</li></ul>
The microwave oven will not run.	<ul style="list-style-type: none"><li>• You are using the oven as a timer. Touch STOP/Clear to cancel the Kitchen Timer.</li><li>• The door is not firmly closed and latched.</li><li>• You did not touch START.</li><li>• You did not follow directions exactly.</li><li>• An operation that you set earlier is still running. Touch STOP/Clear to cancel that operation.</li></ul>

ENGLISH

## COOKING TIMES

PROBLEM	CAUSE
Food is not cooked enough.	<ul style="list-style-type: none"><li>• The electric supply to your home or wall outlets is low or lower than normal. Your electric company can tell you if the line voltage is low. Your electrician or service technician can tell you if the outlet voltage is low.</li><li>• The cook power is not at the recommended setting. Check the chart on Page 15.</li></ul>
The display shows a time counting down but the oven is not cooking.	<ul style="list-style-type: none"><li>• The oven door is not closed completely.</li><li>• You have set the controls as a kitchen timer. Touch STOP/Clear to cancel the Kitchen Timer.</li></ul>

## TURNTABLE

PROBLEM	CAUSE
The turntable will not turn.	<ul style="list-style-type: none"> <li>• The turntable is not correctly in place. It should be correct-side up and sitting firmly on the center hub.</li> <li>• The support is not operating correctly. Remove the turntable and restart the oven. If the support still does not move, call Sears Service at 1-800-4-MY-HOME®. Cooking without the turntable can give you poor results.</li> </ul>

## TONES

PROBLEM	CAUSE
You do not hear the programming or end-of-cycle tone.	<ul style="list-style-type: none"> <li>• You have not entered the correct command.</li> </ul>

## DISPLAY MESSAGES

PROBLEM	CAUSE
The display is flashing “:”.	<ul style="list-style-type: none"> <li>• There has been a power interruption. Reset the clock. (See the “Clock” section on Page 12.)</li> </ul>

If none of these items are causing your problem, call Sears Service at 1-800-4-MY-HOME®