

This Owner's Manual is provided and hosted by [Appliance Factory Parts](http://www.ApplianceFactoryParts.com).



# Coleman 9760-A25 Owner's Manual

[Shop genuine replacement parts for Coleman 9760-A25](#)



[Find Your Coleman Camping Parts - Select From 855 Models](#)

----- Manual continues below -----



**exponent**<sup>®</sup>

**Apollo™**

CSA B140.9.2  
Portable Pressurized Type Liquid  
Petroleum Fuelled Camp Stoves



**Liquid-Fuel Stove  
Instructions for use**

© 2006 The Coleman Company, Inc.  
[www.coleman.com](http://www.coleman.com)

**Model 9760 Series**



Reflector disc and  
windscreen not shown.

U.S. Pat. No. 5,370,527  
Canada Pat. No. 2,089,804  
and other patents pending.

**IMPORTANT**

Read this manual carefully before assembling, using or servicing these stoves. Keep this manual for future reference. If you have questions about assembly, operation, servicing or repair of these stoves, please call Coleman at 1-800-835-3278 or TDD: 316-832-8707. In Canada call 1-800-387-6161.

# FOR YOUR SAFETY

If you smell gas:

1. Do not attempt to light appliance.
2. Extinguish any open flame.
3. Disconnect from fuel supply.

# FOR YOUR SAFETY

Do not store or use gasoline or other liquids with flammable vapors in the vicinity of this or any other appliance.

## ! DANGER



## CARBON MONOXIDE HAZARD

- This appliance can produce carbon monoxide which has no odor.
- Using it in an enclosed space can kill you.
- Never use this appliance in an enclosed space such as a camper, tent, car or home.

This manual contains important information about the assembly, operation and maintenance of this outdoor liquid fuel appliance. General safety information is presented on this page and is also located throughout these instructions. Particular attention should be paid to information accompanied by the safety alert symbol "▲ DANGER", "▲ WARNING", "▲ CAUTION".

Keep this manual for future reference and to educate new users of this product. This manual should be read in conjunction with the labeling on the product.

Safety precautions are essential when any Coleman® fuel or liquid fueled equipment is involved. These precautions are necessary when using, storing, and servicing. Using this equipment with the respect and caution demanded will reduce the possibilities of personal injury or property damage.

The following symbols shown below are used extensively throughout these instructions. Always heed these precautions, as they are essential when using any Coleman® fuel or liquid fueled equipment.

## ! DANGER

DANGER indicates an imminently hazardous situation which, if not avoided, will result in death or serious injury.

## ! WARNING

WARNING indicates a potentially hazardous situation which, if not avoided, could result in death or serious injury.

## ! CAUTION

CAUTION indicates a potentially hazardous situation which, if not avoided, may result in minor or moderate personal injury, or property damage.

## ! DANGER

Failure to comply with the precautions and instructions provided with these stoves can result in death, serious bodily injury and property loss or damage from hazards of fire, explosion, burn, asphyxiation, and/or carbon monoxide poisoning.

Only persons who can understand and follow the instructions should use or service these stoves.

If you need assistance or information such as an instruction manual or labels, contact The Coleman Company, Inc.

### CALIFORNIA PROPOSITION 65:

**WARNING:** This fuel, and byproducts of combustion of this fuel, contain chemicals known to the state of California to cause cancer, birth defects, or other reproductive harm.

## **WARNING**

This liquid fuel appliance may be fueled by Coleman® Liquid Fuel, or unleaded gasoline.

- Never use leaded automotive fuel.
- Do not use Canadian unleaded gasoline.
- Store fuel in a clean, properly marked container away from flame (including pilot lights), other sources of ignition, or excessive heat.

## **DANGER**



### • EXPLOSION - FIRE HAZARD

- During lighting and operation, this product can be a source of ignition. Never use the stove in spaces that contain or may contain volatile or airborne combustibles, or products such as gasoline, solvents, paint thinner, dust particles or unknown chemicals. Minimum clearances from combustible materials: 24 inches from the sides and 48 inches from the top.
- Provide adequate clearances around air openings into the combustion chamber.
- Never attempt to operate stove if any plastic tubing on the pump is missing or damaged.

## **DANGER**



### • EXPLOSION - FIRE HAZARD

- Coleman® fuel and gasoline are extremely flammable; handle with care. Fuel vapors are invisible, explosive, and can be ignited by ignition sources may feet away.
- Always fill outdoors.
- Never open a pressurized Coleman® fuel bottle or fill fuel bottle near flame (including pilot lights), or other ignition sources. It is normal for a pressurized fuel bottle to vent a small amount of fuel mist when unscrewing the bottle from the black pump. Be sure stove has no flame before opening fuel canister.
- Coleman® stove Model 9760 is designed for use only with fuel bottles marked "Model 9760". Never attempt to attach any other fuel bottle to this stove. Never attempt to attach this fuel bottle to any other appliance. Fuel leakage and pump damage can result.

## **WARNING**

Not for home or recreational vehicle use.

We cannot foresee every use which may be made of our products.

**Check with your local fire safety authority if you have questions about use.**

Other standards govern the use of fuel gases and heat producing products for specific uses. Your local authorities can advise you about these.

- Use only Coleman® accessories or parts. During stove set-up, check all fittings for leaks using soapy water. Never use a flame.

## **WARNING**



### • BURN HAZARD

- Never leave stove unattended when hot or in use.
- Keep out of reach of children.

## **⚠ DANGER**



### **• CARBON MONOXIDE HAZARD**

- This stove is a combustion appliance. All combustion appliances produce carbon monoxide (CO) during the combustion process. This product is designed to produce extremely minute, non-hazardous amounts of CO if used and maintained in accordance with all warnings and instructions. Do not block air flow into or out of the stove.
- Carbon Monoxide (CO) poisoning produces flu-like symptoms, watery eyes, headaches, dizziness, fatigue and possibly death. You can't see it and you can't smell it. It's an invisible killer. If these symptoms are present during operation of this product **get fresh air immediately!**
- **For outdoor use only.**
- **Never use inside house, camper, tent, vehicle or other unventilated or enclosed areas. This stove consumes air (oxygen). Do not use in unventilated or enclosed areas to avoid endangering your life.**

## **⚠ CAUTION**

### **• SERVICE SAFETY**

- Keep all connections and fittings clean. Inspect Coleman® fuel canister, hoses, and stove connections for damage before attaching.
- During set up, check all connections and fittings for leaks in one or more ways: **Look** for a fuel mist or a wet appearance of fuel on surfaces. **Listen** for hiss of escaping gas. **Smell** for fuel odor. Never use a flame. **Do not use if leaking.** Check that the connection is not cross-threaded and that it is tight. Perform another leak check. If there is still a leak, remove the canister and contact Coleman for service or repairs.
- Use as a cooking appliance only. Never alter in any way or use with any device or part not expressly approved by Coleman.
- Clean stove frequently to avoid grease accumulation and possible grease fires.
- During Coleman® fuel set-up, check all connections for leaks. **Liquid Coleman® fuel present at connections indicates a leak.**

## **Technical Characteristics**

**Input:** 9,000 BTU/HR Coleman® fuel or unleaded gasoline.

**Category:** Direct pressure liquid fuel stove

**Fuel:** Coleman® fuel or unleaded gasoline.

## **⚠ WARNING**

1. Coleman® Fuel is extremely flammable, handle with extreme care. Fuel vapors are invisible, explosive, and can be ignited by ignition sources many feet away.
2. Always fill outdoors. Never open or fill fuel bottle near flame (including pilot lights), or other ignition sources. It is normal for a pressurized fuel bottle to vent a small amount of fuel mist when unscrewing the bottle from the black pump assembly.
3. Always light and use stove outdoors; never inside house, camper, tent, or other unventilated or enclosed areas.
4. **This stove consumes air (oxygen). Do not use in unventilated or enclosed areas to avoid endangering your life.**
5. When manufactured, this stove is ready to be used with Coleman® Fuel or unleaded gasoline. Be sure you know the type of fuel in the fuel bottle before lighting.
6. This stove is designed to use Coleman® Fuel or unleaded gasoline set up for liquid withdrawal.
7. Store fuel in a clean, properly marked container away from flame (including pilot lights), other sources of ignition, or excessive heat.
8. Use for cooking only. Never alter in any way or use with any device or part not expressly approved by Coleman. Never use as a space heater. Never leave stove unattended while burning.
9. Keep stove away from flammables. Never allow fabric, clothing, or any flammable material come within 48 inches of the top and 24 inches of all sides of the stove.
10. When stove is in use, all metal parts of the stove assembly and generator become extremely hot. **DO NOT TOUCH.**
11. Never place heavy or large capacity utensils on stove. (Maximum weight — 10 lbs.; maximum pot diameter — 6".)
12. When using Coleman® fuel, never attempt to operate stove if any plastic tubing on the black pump assembly is out of place, missing or damaged.
13. Keep out of reach of children.

# 1 Becoming Familiar with your Coleman® liquid fuel Stove

Thank you for purchasing your new Coleman® liquid fuel stove. The stove is a high performance liquid fuel cooking appliance. We recommend operating the stove in a safe location outside your home to familiarize yourself with its liquid fuel operation before your next outdoor experience.

## Helpful Hints

- Consider carrying your spare parts and tools for stove servicing.
- Using the windscreen and reflective disk will usually decrease your water boiling times.
- For best results, always use Coleman® Filter/Funnel Part No. 814-515T.
- If necessary, unleaded gasoline may be substituted for liquid Coleman® fuel.
- Do not use kerosene in this stove.

■ When lighting and using your Coleman® liquid fuel stove, this manual refers to this illustration to identify the different types of flames:

### HIGH FLAME - Yellow (Turn off stove)

(Excessive height indicates burner is flooding with fuel - see troubleshooting section)

### START-UP FLAME - Yellow

(Normal cold start - flame will settle to cooking flame in about one minute)

### COOKING FLAME - Blue

(Normal)

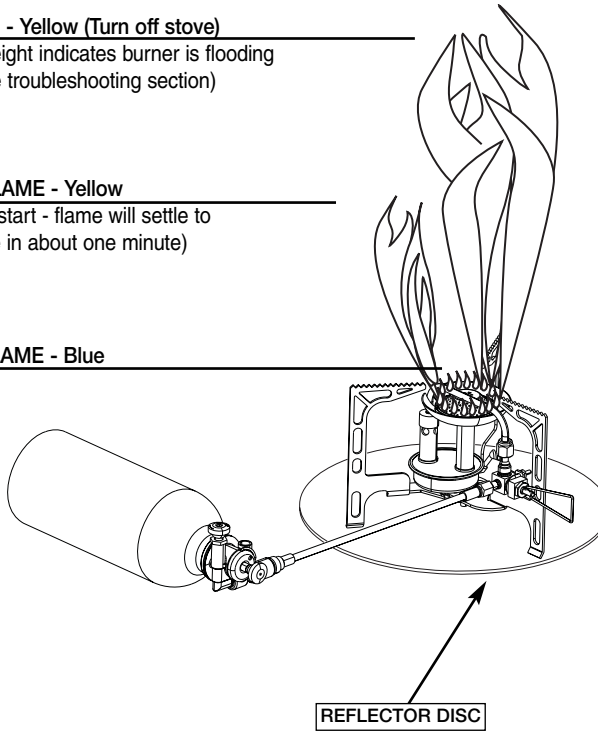

## CAUTION

Always place the stove on the reflector disc during setup and use. The disc must be used to help protect combustible surfaces from excess heat and cooking splatter.

## HELPFUL HINT:

A windscreen is provided with your stove to improve performance in windy conditions. See **Section 9** for additional information concerning setup and use of the reflector disc and windscreen.

## 2 Identification

### READ AND FOLLOW ADDITIONAL INSTRUCTIONS ON THE FUEL BOTTLE.

**NOTE:** The reflector disc and windscreen are not illustrated in the set up instructions. This is so the features of the stove may be clearly visible and identified. Read about the reflector disc and windscreen in **Sections 1 and 9**.

## **⚠ DANGER**



### • CARBON MONOXIDE HAZARD

- For outdoor use only.
- Never use inside house, camper, tent, vehicle or other unventilated or enclosed areas. This stove consumes air (oxygen). Do not use in unventilated or enclosed areas to avoid endangering your life.

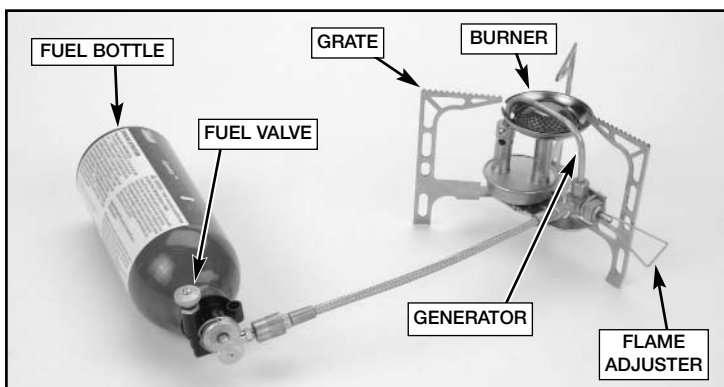
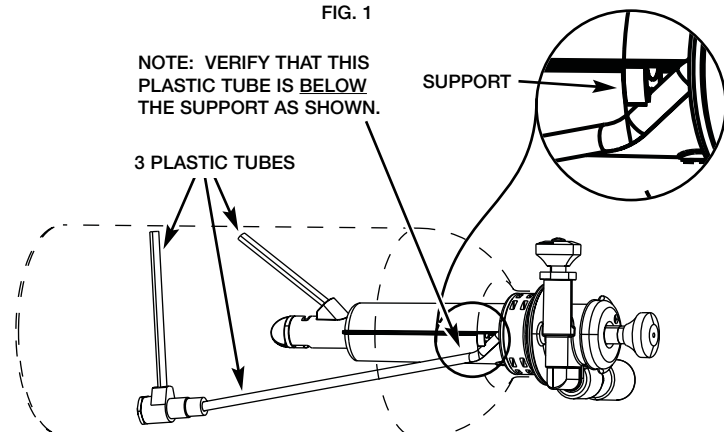

FIG. 1

**NOTE:** VERIFY THAT THIS PLASTIC TUBE IS BELOW THE SUPPORT AS SHOWN.



**FOR PROPER OPERATION MAKE SURE ALL 3 PLASTIC TUBES ARE PRESENT AND POSITIONED AS SHOWN.**

FIG. 2

English-5

### 3 Stove Set Up

**NOTE:** The reflector disc and windscreen are not illustrated in the set up instructions. This is so the features of the stove may be clearly visible and identified. Read about the reflector disc and windscreen in **Sections 1 and 9**.

- Unfold stove legs to stops and place on reflector disc. (Fig. 3, 4, and 5)



FIG. 3



FIG. 4



FIG. 5

### 4 To Fill Tank

**NEVER FILL OR LIGHT STOVE INSIDE HOUSE, CAMPER, OR TENT.**

- Unscrew bottle from black pump assembly (Fig. 6 and 7).



FIG. 6



FIG. 7

- Use a funnel or suitable filling device and fill with clean, fresh Coleman® fuel.

- Fill bottle no more than 2/3 full (16 Fl. Oz.). Overfilling can result in fuel leakage and flare up during lighting. Your index finger can be used to check the fuel level. Insert index finger into fuel bottle as shown in Figure 9. If finger touches fuel, the bottle is too full. Pour out small amount of fuel until bottle is at the proper level. (Fig. 8)

- Make sure FUEL VALVE is fully "OFF" (Fig. 10)

- Check "O" ring for damage and carefully insert black pump assembly into fuel bottle and hand tighten. (Fig. 11)

- Replace FUEL CAP on fuel container. Tighten firmly. Move fuel container away from stove. WIPE UP ANY SPILLED FUEL AND DISPOSE OF IN A SAFE PLACE.

FUEL  
FUNNEL



FIG. 8



FIG. 9

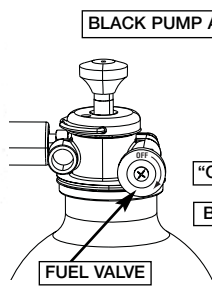

FIG. 10

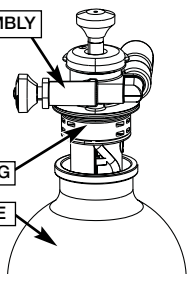

FIG. 11



## 5 To Attach Fuel Bottle

- Make sure FUEL VALVE is fully "OFF" (Fig 12).
- Connect hose to threaded fitting on fuel bottle, making sure the bottle is lying on its side with the fuel valve up. Hand tighten the connection (Fig. 13).



FIG. 12



FIG. 13

**Note: For proper lighting, perform Step 6 ONLY for the first time use "out of the box" or when pump is dry (for example, after extended storage). This step is not required during subsequent lighting.**

## 6 Initial Fueling of Dry Pump

- Make sure FUEL VALVE is fully "OFF" (Fig 14).
- Turn flame adjuster to "High/Light" (Fig. 15).
- Place thumb over hole in PUMP KNOB and pump five full strokes (Fig 16).
- Open fuel valve on bottle 1/2 turn for five seconds, then close fuel valve.

NOTE: Air in the dry pump is now replaced with liquid fuel. Proceed to Step 7.



FIG. 14

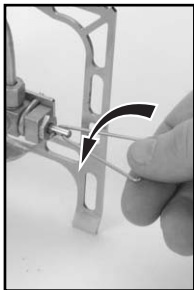

FIG. 15



FIG. 16

## 7 To Pump

- Make sure FUEL VALVE is fully "OFF" (Fig 17).
- Place thumb over hole in PUMP KNOB and pump 25 full strokes (Fig 18). Adequate air pressure is important, do not over pump.



FIG. 17



FIG. 18

## 8 Leak Check

### ⚠ WARNING

- Perform leak test outdoors.
- Extinguish all open flames.
- NEVER leak test when smoking.
- Do not use the outdoor stove until connection has been leak tested and does not leak.

### ⚠ WARNING



#### • BURN HAZARD

- Never leave stove unattended when hot or in use.
- Keep out of reach of children.

- Make sure FUEL VALVE is fully "OFF" (Fig. 19).
- CHECK FOR LEAKS in one or more ways: **Look** for a fuel mist or a wet appearance of fuel on surfaces. **Listen** for hiss of escaping gas. **Smell** for fuel odor. Never use a flame. **Do not use if leaking.**

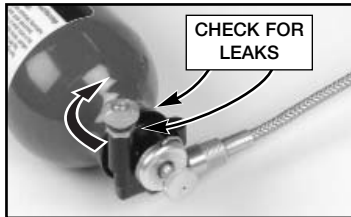

Liquid Fuel Canister

FIG. 19

# 9 To Light

## NEVER FILL OR LIGHT STOVE INSIDE HOUSE, CAMPER, OR TENT.

- Make sure fuel bottle is lying level on its side with the **FUEL VALVE** up (Fig. 20).
- Turn flame adjuster back and forth several times to clean generator tip (Fig. 21).
- Turn flame adjuster to "High/Light" (Fig. 22).
- Hold lighted match at burner and then open fuel valve (Fig. 20 and 23).
- **CAUTION:** If stove burns with a high yellow flame or if liquid fuel appears in the burner, immediately turn **FUEL VALVE** "OFF". Allow stove to cool. Carefully review the troubleshooting section before relighting stove.
- After stove warms up (approx. 1 minute), pump an additional 40 strokes. Flame may be adjusted to desired heat with **FLAME ADJUSTER**. Periodically turn flame adjuster back and forth several times to clean generator tip (Fig. 21).
- Pump as required to maintain flame height.

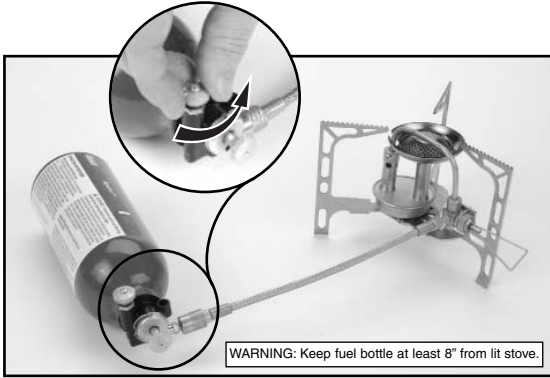

FIG. 20

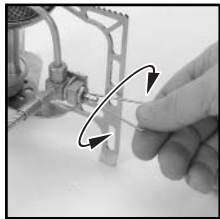

FIG. 21

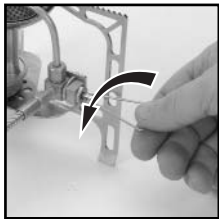

FIG. 22



FIG. 23

# 10 To Turn Off

- Turn **FUEL VALVE** fully "OFF" (Fig. 24).
- Be sure flame is extinguished. Flame will linger on burner for 1-2 minutes after fuel valve is "OFF".

## **⚠ WARNING**

- Always turn fuel valve off before removing hose. Never remove hose from bottle near ignition sources, while stove is lit, or hot to touch.



**FUEL VALVE**

FIG. 24

## **⚠ DANGER**



### • EXPLOSION - FIRE HAZARD

- Always attach or detach fuel canisters outdoors; never while stove is lighted, near flame, pilot lights, other ignition sources or while stove is hot to touch.
- This stove is very hot during use and can ignite flammables too close to the burners. Keep flammables at least 24 inches from the sides and 48 inches from the top of the stove. Keep gasoline and other flammable liquids and vapors well away from stove.
- The stove must not be exposed to flammable vapors or liquids during lighting.

## 11 Using the Reflector Disc and Windscreen

### **⚠ CAUTION**

Always place the stove on the reflector disc during setup and use. The disc must be used to help protect combustible surfaces from excess heat and cooking splatter.

- Always place the stove on the reflector disc during setup and use.
- To improve stove performance in windy conditions, unfold the windscreen and place it around the stove. Fold the ends together. Place the windscreen so that the notched end is down and allows access to the flame adjuster (Fig. 25).
- Roll or gently fold the windscreen for storage.



FIG. 25

# 12 To Store

- Make sure stove is cool.
- Move stove away from flame (including pilot lights) and other ignition sources.
- Disconnect the fuel hose at the threaded fitting attached to the fuel bottle.
- If some liquid fuel remains in the fuel hose, drain the excess fuel before placing the stove in your backpack or storage container.
- Replace the protective caps onto the threaded fittings.
- The stove may be folded for compact storage (Fig. 26).

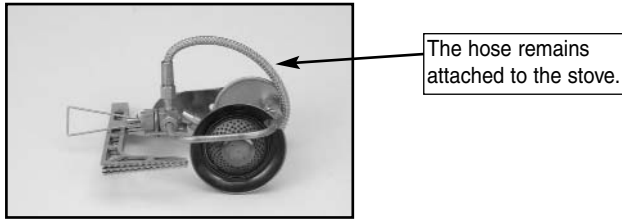

FIG. 26

## • MAINTENANCE

- Keep stove area clear and free from combustible materials, gasoline and other flammable vapors and liquids.
- Do not obstruct the flow of combustion and ventilation air.
- A good flame should be blue with minimal yellow tip. Some yellow tips on flames are acceptable as long as no carbon or soot deposits appear.
- Wipe clean with soft cloth and mild dish detergent. Do not use abrasives.

Symptom	Problem	Solution
Burner will not light or flame self-extinguished.	The fuel pump is shipped from the factory dry of fuel or the stove has been in extended storage.	Read and follow the section titled "Initial Fueling of Dry Pump" (see page 7).
Burner will not light or flame self-extinguished.	Fuel bottle empty.	Refill fuel bottle 2/3 full with clean and fresh Coleman® fuel or unleaded fuel.
Burner will not light or flame is low or flame self-extinguished.	Little or no pressure in fuel bottle.	Check connections for leaks and pump 40 strokes.
Yellow flame.	Excess fuel in burner.	A yellow flame is normal until the generator warms up. If yellow flame persists, turn off stove, allow flame to self-extinguish and the stove to cool. If necessary, invert stove to remove excess liquid fuel from the burner. Follow lighting instructions.
Low heat.	Generator tip plugged.	Turn flame adjuster back and forth several times to clean generator tip. Be sure to use only fresh and clean fuel.
Low heat.	Faulty generator.	Replace with a new generator. This is a normal periodic maintenance procedure. The generator life is dependent on the type of fuel used. Generator life is extended by using clean Coleman® fuel.
Persistent small yellow flame.	Faulty generator.	Replace with a new generator.
Persistent high yellow flame.	Failure in the fuel delivery system.	May need to replace pump assembly. Please contact Consumer Service (see page 15).
Intermittent short blue flame and rapid loss of pressure.	Failure in the fuel delivery system.	May need to replace pump assembly. Please contact Consumer Service (see page 15).
Yellow smokey flame.	Spider webs, insects, or other obstruction in the burner and air tube.	Remove burner to inspect and clean the burner and air tube.
Pump does not pressurize the liquid fuel canister.	Pump seals are dry or worn.	Squirt a few drops of oil in the <b>OIL HOLE</b> in the pump cap. This will keep the pump functioning properly (Fig. 26). If this does not correct the problem, replace the pump seals or purchase a new pump assembly.
Intermittent yellow flame.	Stove has been operated for an extended period of time at a low heat setting.	Adjust the flame to a higher setting with the FLAME ADJUSTER.

# Replacement Parts List

Item	Part No.	Description
1	9770-5051	Plunger Assembly
2	9770-5551	Pump and Valve Assembly
3	R9760-501	Stove Maintenance Kit (includes one item on the next page)
4	9770-5611	Service Parts Kit (includes one item on the next page)
5	9760-5081	Fuel Bottle Assembly (22 fl. oz. capacity)

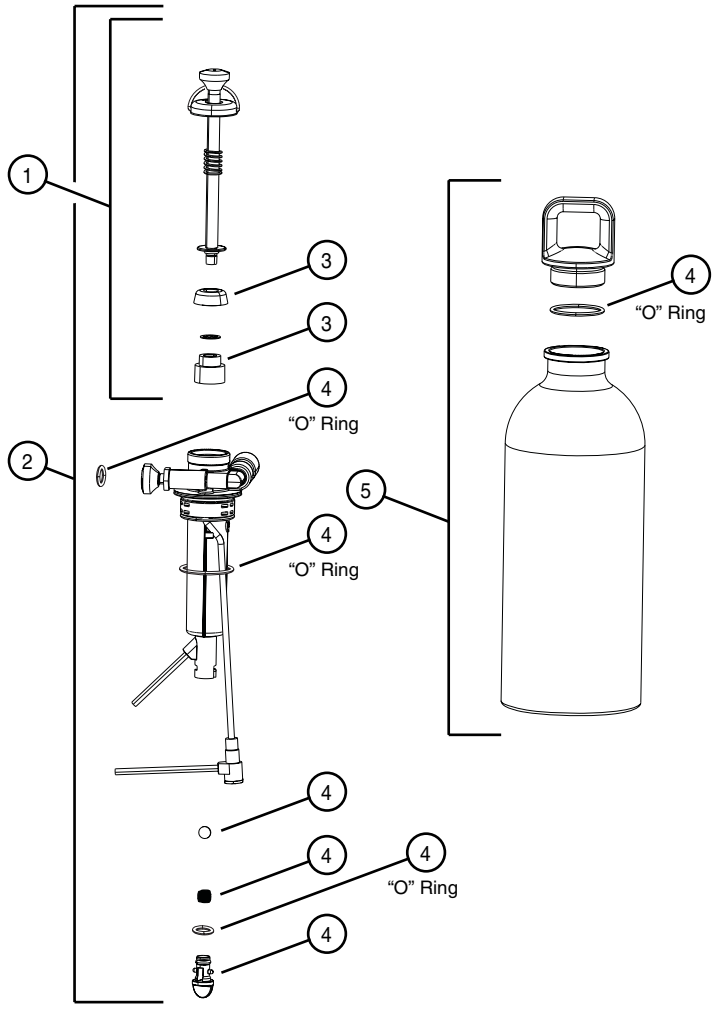

# Replacement Parts List

Item	Part No.	Description
6	9780-5271	Burner Assembly Complete w/ Hdwe
7	9760-5201	Stove Leg Kit (3 pk)
8	9760-5251	Valve Assembly
9	9770-5151	Hose Assembly with Cap
10	R9770-120	Windscreen and Reflector Disc

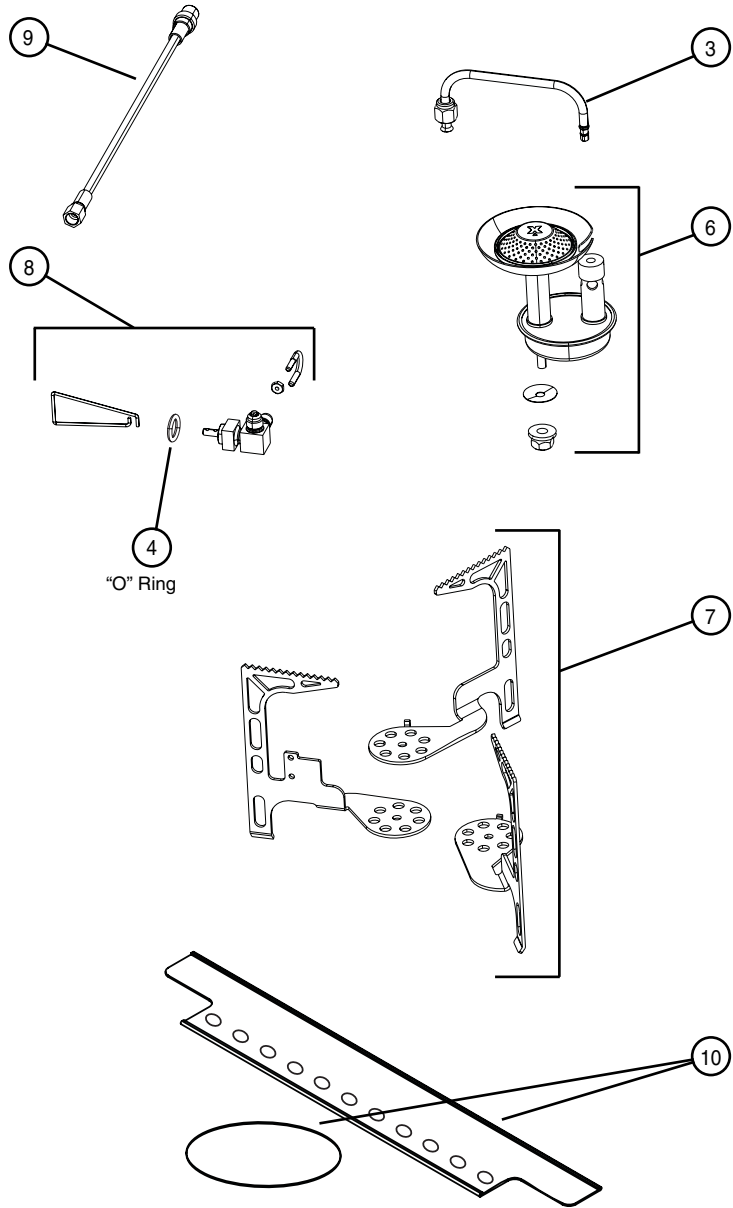



## Limited Five Year Warranty

The Coleman Company, Inc. ("Coleman") warrants that for a period of five years from the date of original retail purchase, this product will be free from defects in material and workmanship. Coleman, at its option, will repair or replace this product or any component of the product found to be defective during the warranty period. Replacement will be made with a new or remanufactured product or component. If the product is no longer available, replacement may be made with a similar product of equal or greater value. This is your exclusive warranty.

This warranty is valid for the original retail purchaser from the date of initial retail purchase and is not transferable. Keep the original sales receipt. Proof of purchase is required to obtain warranty performance. Coleman dealers, service centers, or retail stores selling Coleman® products do not have the right to alter, modify or in any way change the terms and conditions of this warranty.

### What This Warranty Does Not Cover

This warranty does not cover normal wear of parts, parts that are not genuine Coleman® parts, or damage resulting from any of the following: negligent use or misuse of the product; use on improper voltage or current; commercial use of the product; use contrary to the operating instructions; disassembly, repair or alteration by anyone other than Coleman or an authorized service center. Further, the warranty does not cover Acts of God, such as fire, flood, hurricanes and tornadoes. Warranty void if damage to product results from the use of a part other than a genuine Coleman® part.

**COLEMAN SHALL NOT BE LIABLE FOR DEFECTS THAT ARE CAUSED BY THE USE OF UNAUTHORIZED PARTS OR SERVICE. COLEMAN SHALL NOT BE LIABLE FOR ANY INCIDENTAL OR CONSEQUENTIAL DAMAGES CAUSED BY THE BREACH OF ANY EXPRESS OR IMPLIED WARRANTY OR CONDITIONS. EXCEPT TO THE EXTENT PROHIBITED BY APPLICABLE LAW, ANY IMPLIED WARRANTY OF MERCHANTABILITY OR FITNESS FOR A PARTICULAR PURPOSE IS LIMITED IN DURATION TO THE DURATION OF THE ABOVE WARRANTY OR CONDITIONS. SOME STATES, PROVINCES, OR JURISDICTIONS DO NOT ALLOW THE EXCLUSION OR LIMITATION OF INCIDENTAL OR CONSEQUENTIAL DAMAGES OR LIMITATIONS ON HOW LONG AN IMPLIED WARRANTY LASTS, SO THE ABOVE LIMITATIONS OR EXCLUSION MAY NOT APPLY TO YOU. THIS WARRANTY GIVES YOU SPECIFIC LEGAL RIGHTS, AND YOU MAY ALSO HAVE OTHER RIGHTS THAT VARY FROM STATE TO STATE OR PROVINCE TO PROVINCE.**

### How to Obtain Warranty Service

Take the product to an authorized Coleman service center. You can find the nearest authorized Coleman service center by visiting [www.coleman.com](http://www.coleman.com) or calling 1-800-835-3278 or TDD 316-832-8707 in the United States or 1 800 387-6161 in Canada. If a service center is not conveniently located, attach to the product a tag that includes your name, address, daytime telephone number and description of the problem. Include a copy of the original sales receipt. Carefully package the product and send either by **courier** or **insured mail** with shipping and **insurance** prepaid to:

**For products purchased in the United States:**  
The Coleman Company, Inc.  
3600 North Hydraulic  
Wichita, KS 67219

**For products purchased in Canada:**  
Sunbeam Corporation (Canada) Limited  
DBA Jarden Consumer Solutions  
5975 Falbourne Street  
Mississauga, Ontario  
Canada L5R 3V8

The costs of transporting the product to Coleman or an authorized service center for warranty service is the responsibility of the purchaser.

Do not mail products with fuel in tanks, or with disposable LPG canisters. Remove glass globes from lanterns and wrap separately.

**DO NOT RETURN THIS PRODUCT TO THE PLACE OF PURCHASE.**

If you have any questions regarding this warranty please call 1-800-835-3278 or TDD 316-832-8707 in the United States or 1 800 387-6161 in Canada.

1. It is not unusual for the stove to produce a slight pulsating or "chugging" noise during operation.
2. During operation for an extended period at a low heat setting, you may notice an intermittent yellow flame. This can be corrected by adjusting the flame to a slightly higher level with the **FLAME ADJUSTER**.
3. Seasonally or before storage, squirt a few drops of oil into the **OIL HOLE** in the pump cap. This will keep the pump functioning properly. (Fig. 27)
4. The flame adjuster moves a small needle in and out of the generator gas tip. If stove is hard to light or does not produce full heat output, turn flame adjuster back and forth several times to clean generator.
5. Unleaded fuels may vary in quality and can affect generator life and performance. If you are having a problem with your stove or generator using unleaded fuel, replace the generator and try a different brand of unleaded fuel. Canadian unleaded gasoline, unlike U.S. produced fuels, contain manganese compounds that are unacceptable to both generator performance and reliability.
6. The usual storage areas for camping and picnic equipment are the basement, attic, or garage. To avoid the accumulation of dust, cobwebs, etc., that is common in these areas, place your stove in a plastic bag and seal it with a rubber band.
7. For repair service call one of the numbers listed below for location of your nearest Coleman Service Center. If stove must be mailed to a Service Center, attach to the product a tag that includes your name, address, daytime telephone number and a description of problem. Carefully package the product and send either by **courier** or **insured mail** with shipping and **insurance** prepaid to:

**For products purchased in the United States:**  
The Coleman Company, Inc.  
3600 N. Hydraulic • Wichita, KS 67219 U.S.A.  
1-800-835-3278 • TDD: 316-832-8707

**For products purchased in Canada:**  
Sunbeam Corporation (Canada) Limited  
DBA Jarden Consumer Solutions  
5975 Falbourne Street  
Mississauga, ON, Canada L5R 3V8  
1-800-387-6161

8. If not completely satisfied with the performance of this product, please call one of the numbers listed above.





FIG. 27



The Coleman Company, Inc. • 3600 North Hydraulic • Wichita, KS 67219 U.S.A.  
1-800-835-3278 • TDD: 316-832-8707

Sunbeam Corporation (Canada) Limited • DBA Jarden Consumer Solutions  
5975 Falbourne Street  
Mississauga, Ontario, Canada L5R 3V8 • 1 800 387-6161

© 2006 The Coleman Company, Inc. All rights reserved. Coleman®, Exponent®, and  are registered trademarks and Apollo™ is a trademark of The Coleman Company, Inc.

© 2006 The Coleman Company, Inc. Tous droits réservés. Coleman®, Exponent®, et  sont des marques déposées alors que Apollo™ est une marque de commerce de The Coleman Company, Inc.

© 2006 The Coleman Company, Inc. Todos los derechos reservados. Coleman®, Exponent®, y  son marcas registradas y Apollo™ es una marca de la compañía The Coleman Company, Inc.

[www.coleman.com](http://www.coleman.com)

9760A054 (5/31/06)