

This Owner's Manual is provided and hosted by [Appliance Factory Parts](http://Appliance Factory Parts).

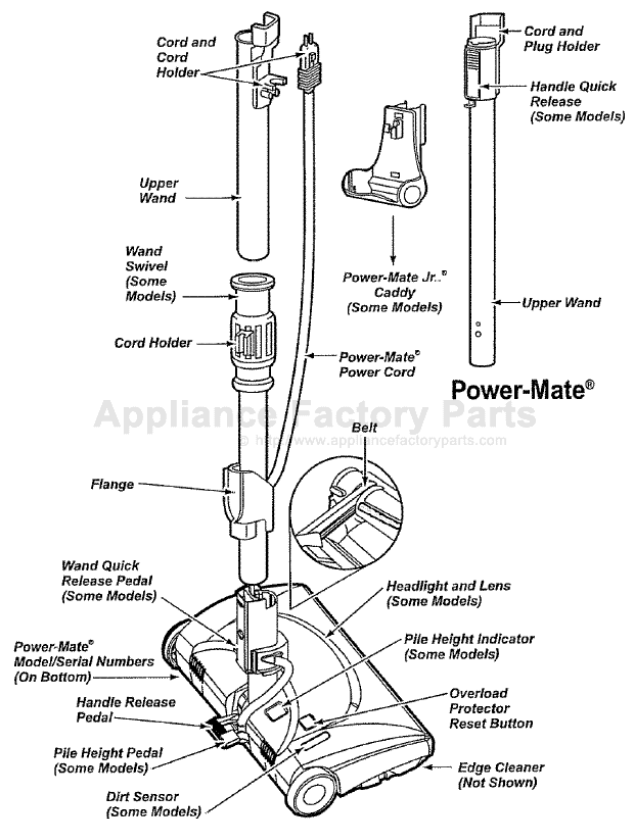

# Kenmore 116.2261200 Owner's Manual

[Shop genuine replacement parts for Kenmore  
116.2261200](#)



[Find Your Kenmore Vacuum Cleaner Parts - Select From 745 Models](#)

----- Manual continues below -----

# *Owner's Manual*

## *Manual Del Propietario*



*Vacuum Cleaner*

*Aspiradora*

Model, Modelo            116.22612  
                                     116.22613



**CAUTION:**

Read and follow all safety and operating instructions before first use of this product.

**CUIDADO:**

Lea y siga todas las instrucciones de operación y seguridad antes del uso de este producto.

Sears, Roebuck and Co., Hoffman Estates, IL 60179 U.S.A.  
[www.sears.com](http://www.sears.com)

Part No. C01ZBPW40U00-8192062

Printed in U.S.A.  
Impreso en EUA

ENGLISH

ESPAÑOL

## TABLE OF CONTENTS

<b>Before Using Your New Vacuum</b> . . . . .	2	<b>Canister Care</b> . . . . .	14
<b>Kenmore Vacuum Cleaner Warranty</b> . . . . .	2	Bag Changing . . . . .	14
<b>Important Safety Instructions</b> . . . . .	3	Cleaning Exterior and Attachments . . . . .	15
<b>Parts and Features</b> . . . . .	4-5	Motor Safety Filter Changing . . . . .	15
<b>Assembly Instructions</b> . . . . .	6-7	Exhaust Filter Changing . . . . .	16
<b>Use</b> . . . . .	8	<b>Power-Mate® Care</b> . . . . .	16
How to Start . . . . .	8	Belt Changing and Agitator Cleaning . . . . .	17-18
Vacuuming Tips . . . . .	9	Light Bulb Changing . . . . .	18
Suggested Pile Height Settings . . . . .	9	Agitator Servicing . . . . .	19
Dirt Sensor . . . . .	10	Agitator Assembly . . . . .	19
Attachments . . . . .	11	<b>Troubleshooting</b> . . . . .	20
Attachment Use Chart . . . . .	12	<b>Requesting Assistance</b>	
Performance Features . . . . .	12-13	<b>Or Service</b> . . . . .	Back Cover
<b>How Your Vacuum Works</b> . . . . .	14		

## BEFORE USING YOUR NEW VACUUM

Please read this guide. It will help you assemble and operate your new Kenmore vacuum in the safest and most effective way.

For more information about vacuum cleaner care and operation, call your nearest Sears store. You will need the complete model and serial numbers when requesting information. Your vacuum's model and serial numbers are located on the Model and Serial Number Plate.

Use the space below to record the model number and serial number of your new Kenmore vacuum.

Model No. \_\_\_\_\_

Serial No. \_\_\_\_\_

Date of Purchase \_\_\_\_\_

Keep this book and your sales check (receipt) in a safe place for future reference.

## KENMORE VACUUM CLEANER WARRANTY

### LIMITED ONE YEAR WARRANTY ON KENMORE VACUUM CLEANER

This warranty is for one year from the date of purchase, and includes only private household vacuum cleaner use. During the warranty year, when this vacuum cleaner is operated and maintained according to the owner's manual instructions, Sears will repair any defects in material or workmanship free of charge.

This warranty excludes vacuum bags, belts, light bulbs, and filters, which are expendable parts and become worn during normal use.

**For warranty service, return this vacuum cleaner to the nearest Sears Service Center in the United States.**

This warranty applies only while this product is in use in the United States. This warranty gives you specific legal rights, and you may also have other rights which vary from state to state.

**Sears, Roebuck and Co., D/817 WA, Hoffman Estates, IL. 60179**

# IMPORTANT SAFETY INSTRUCTIONS



## WARNING

Your safety is important to us. To reduce the risk of fire, electrical shock, injury to persons or damage when using your vacuum cleaner, follow basic safety precautions including the following:

**Read** this manual before assembling or using your vacuum cleaner.

**Use** your cleaner only as described in this manual. Use only with Sears recommended attachments.

To reduce the risk of electrical shock – **Do not** use outdoors or on wet surfaces.

**Disconnect** electrical supply before servicing or cleaning out agitator area. Failure to do so could result in electrical shock or brush suddenly starting.

**Always** turn cleaner off before connecting or disconnecting the hose or Power-Mate®.

**Always** turn cleaner off before unplugging.

**Do not** unplug by pulling on cord. To unplug, grasp the plug, not the cord.

**Hold** plug when rewinding onto cord reel. Do not allow plug to whip when rewinding.

**Do not** use with damaged cord or plug. If cleaner is not working as it should, has been dropped, damaged, left outdoors, or dropped into water, return it to a Sears Service Center.

**Do not** pull or carry by cord, use cord as a handle, close door on cord, or pull cord around sharp edges or corners. Do not run cleaner over cord. Keep cord away from heated surfaces.

**Do not** leave cleaner when plugged in. Unplug from outlet when not in use and before servicing.

**Do not** allow to be used as a toy. Close attention is necessary when used by or near children.

**Do not** handle plug or cleaner with wet hands.

**Do not** put any objects into openings.  
**Do not** operate the cleaner with a punc-

tured hose. The hose contains electrical wires. Replace if cut or worn. Avoid picking up sharp objects.

**Do not** use with any opening blocked; keep free of dust, lint, hair and anything that may reduce air flow.

**Keep** hair, loose clothing, fingers, and all parts of body away from openings and moving parts.

**Do not** use cleaner without dust bag and/or filters in place.

**Always** change the dust bag after vacuuming carpet cleaners or freshener, powders and fine dust. These products clog the bag, reduce airflow and can cause the bag to burst. Failure to change bag could cause permanent damage to the cleaner.

**Do not** use the cleaner to pick up sharp hard objects, small toys, pins, paper clips, etc. They may damage the cleaner or dust bag.

**Do not** pick up anything that is burning or smoking, such as cigarettes, matches, or hot ashes.

**Do not** use cleaner to pick up flammable or combustible liquids (gasoline, cleaning fluids, perfumes, etc.), or use in areas where they may be present. The fumes from these substances can create a fire hazard or explosion.

**Use extra care** when cleaning on stairs. Do not put on chairs, tables, etc. Keep on floor.

**You** are responsible for making sure that your vacuum cleaner is not used by anyone unable to operate it properly.

**Do not** operate without exhaust filter or exhaust filter cover installed.

ENGLISH

## SAVE THESE INSTRUCTIONS

Proper assembly and safe use of your vacuum cleaner are your responsibilities. Your cleaner is intended only for household use. Read this Owner's Manual carefully for important use and safety information. This guide contains safety statements under warning and caution symbols. Please pay special attention to these boxes and follow any instructions given. **WARNING** statements alert you to such hazards as fire, electrical shock, burns and personal injury. **CAUTION** statements alert you to such hazards as personal injury and/or property damage.

## PARTS AND FEATURES

It is important to know your vacuum cleaner's parts and features to ensure its proper and safe use. Review these before using your cleaner.

Item	Part No. In U.S.	Part No. In Canada
Headlight Bulb	20-5240	596181
Belt	20-5201	20-40979

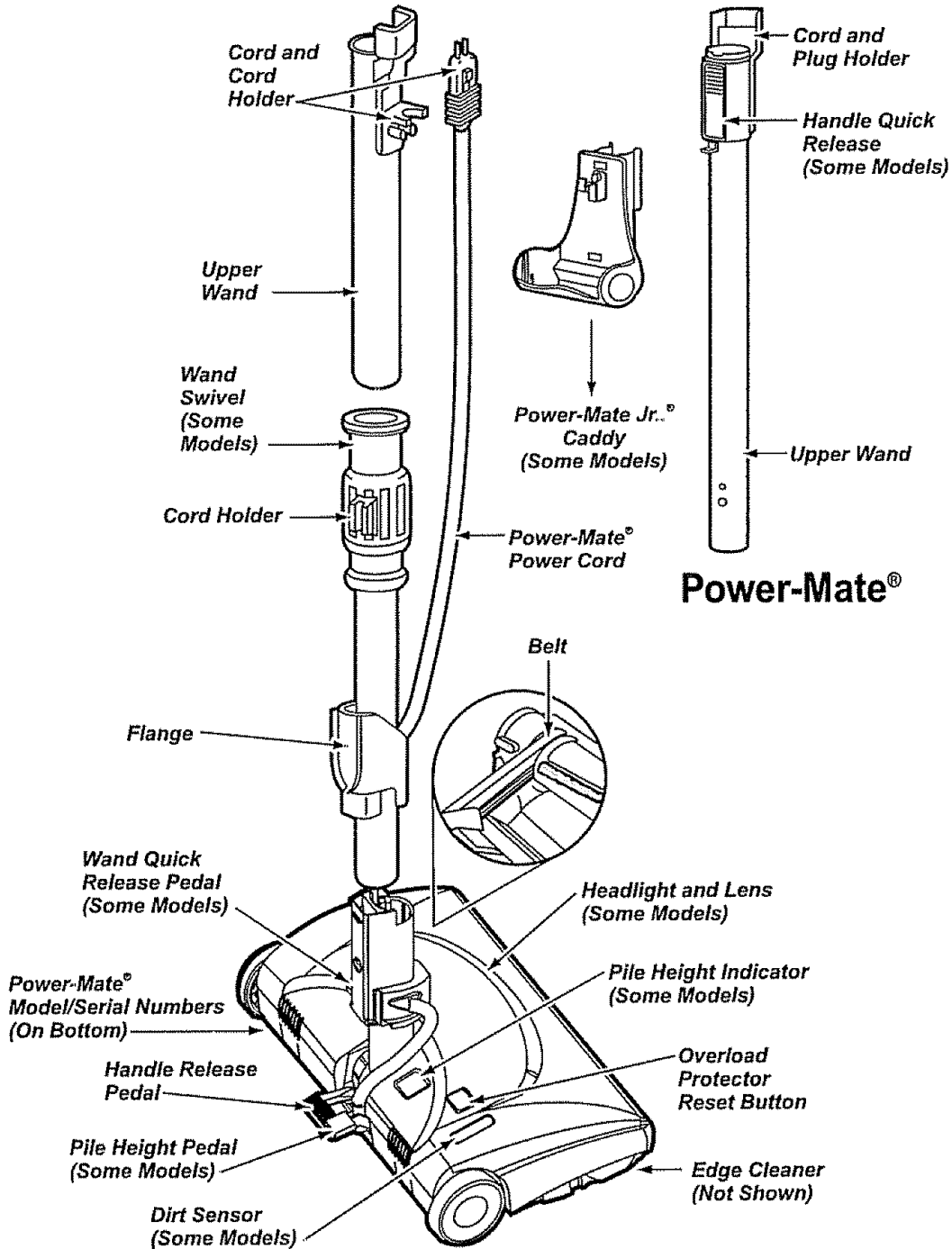

# HOSE

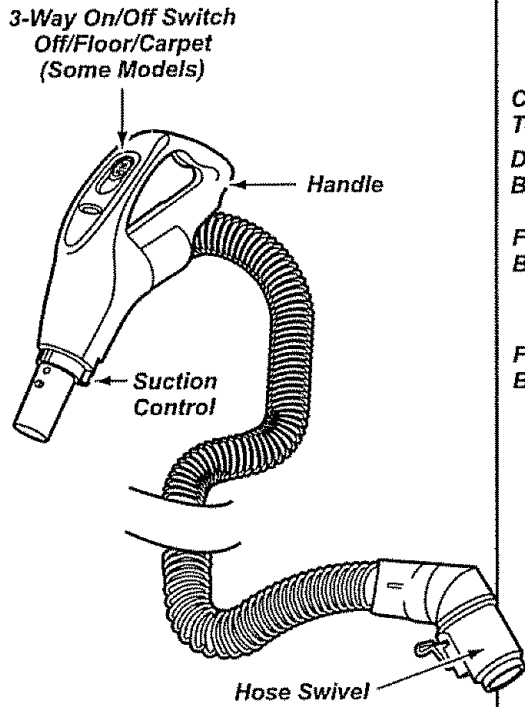

# ATTACHMENTS

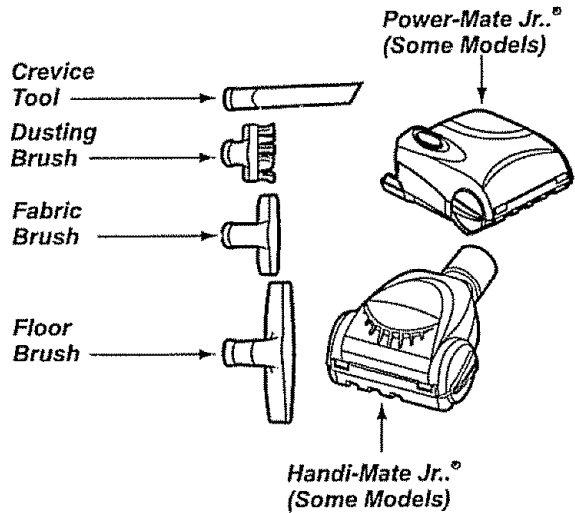

**NOTE:** All models have one set of attachments in the canister. Some models have an additional set, which can be kept in the accessory bag for garage use or other dirty areas.

ENGLISH

# CANISTER

Item	Part No. In U.S.	Part No. In Canada
Dust Bag	20-50557	20-50557C
Exhaust Filter	20-86880	20-86880C
Motor Safety Filter	20-86883	20-86883C

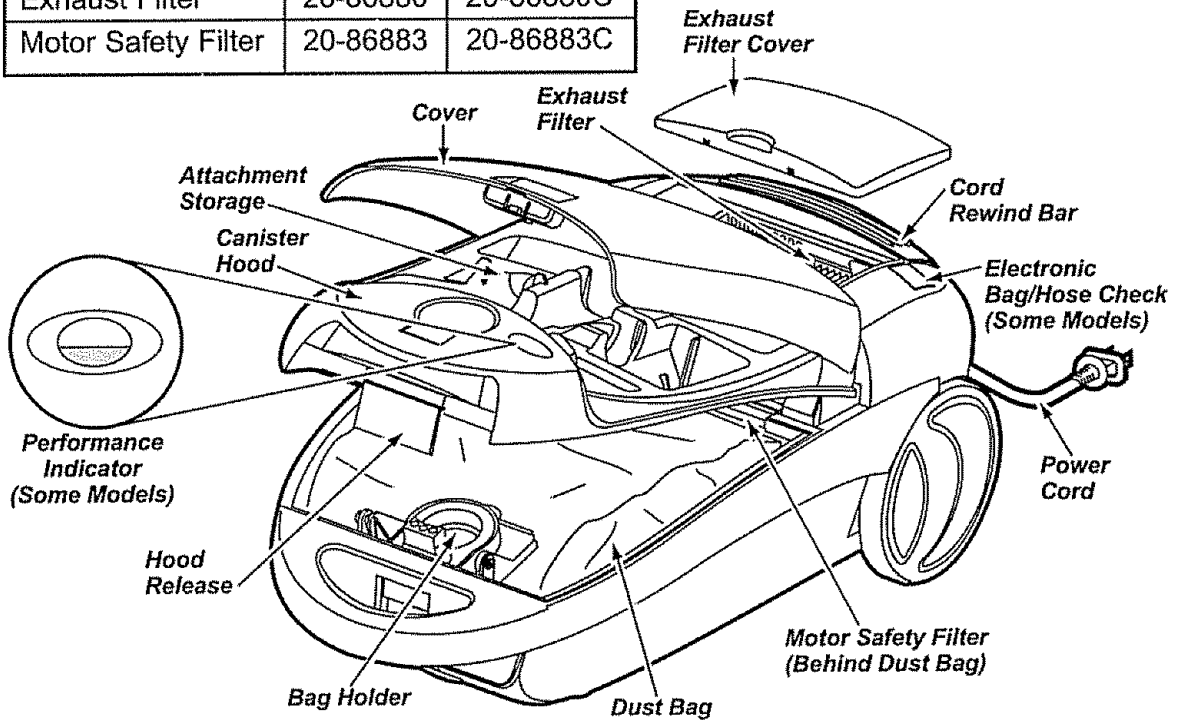

# ASSEMBLY INSTRUCTIONS



## WARNING

**Electrical Shock Hazard**  
**DO NOT** plug into electrical supply until assembly is complete. Failure to do so could result in electrical shock or injury.

Before assembling vacuum, check the PACKING LIST on the cover of the separate Repair Parts List. Use this list to verify that you have received all the components of your new Kenmore vacuum.

## WANDS

Slide wands together until wand button snaps into place. Turn wand button to the slotted area of the wand swivel.

The swivel allows you to turn the handle to the left side to reach farther under low furniture.

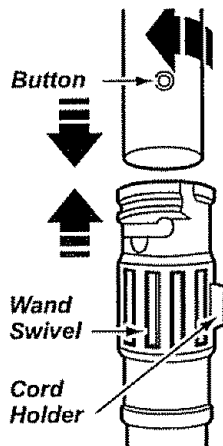

## Power-Mate®

1. Insert wands into Power-Mate® until the wand buttons snap into place.

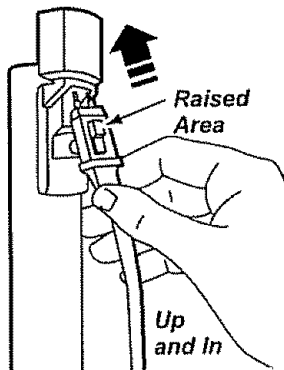

2. Connect Power-Mate® plug and cord as shown. **DO NOT force.** Raised area of plug must be toward hand.

3. Secure cord into cord holder on wand swivel.

**To remove:** Step on wand quick release pedal, then pull up on wands.

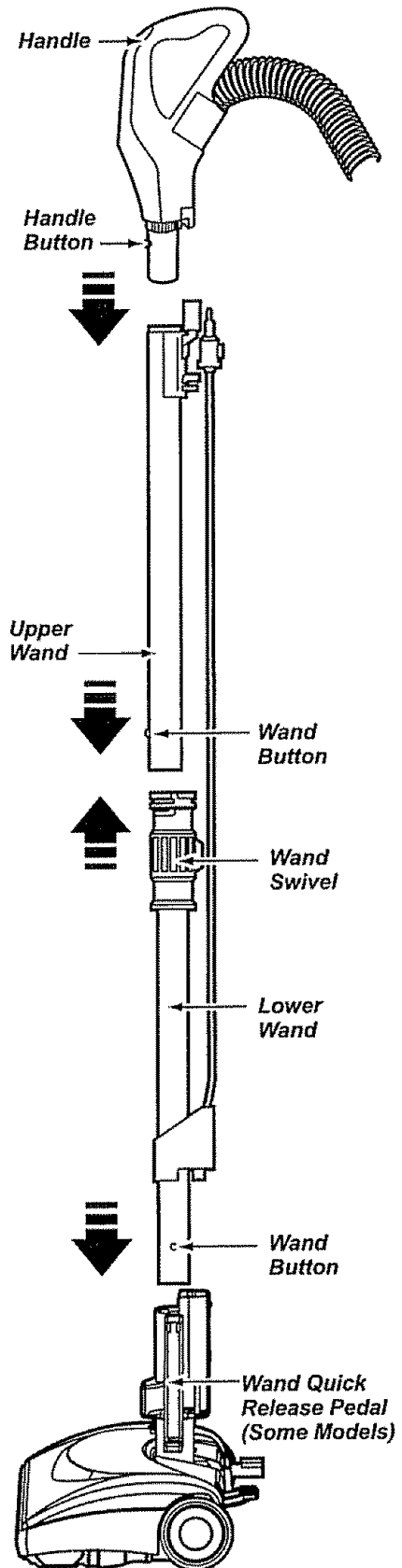

## CANISTER

1. Open the canister hood.
2. Check to see that the dust bag is properly installed. See BAG CHANGING for instructions.
3. Check to see that the motor safety filter is properly installed. See MOTOR SAFETY FILTER CLEANING for instructions.

## HOOD AND COVER

It is normal for the canister hood and cover to come off when opened further than needed. Line up the hinge slots, insert the hinges into the slots, and close the hood and cover to reinstall.



### CAUTION

Never open canister hood with the cover open. This will help to prevent damage from occurring to the canister hood and/or cover.

## HOSE

1. Line up the hose latch tab and notch in canister hood and insert hose into canister until it snaps in place.

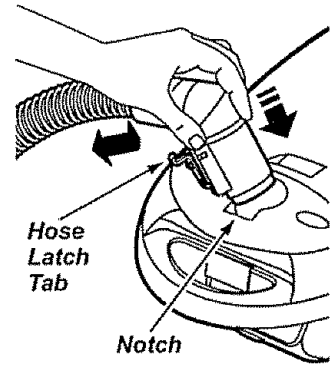

**To remove:** Lift hose latch tab upward and pull up on hose.

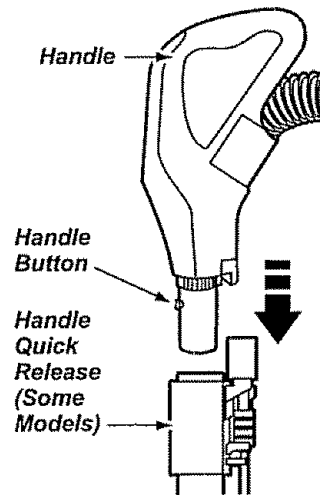

2. Insert handle into wand until lock button snaps in place. **Be sure hose is not twisted.**

**To remove:** Press handle quick release button and pull up on handle.

ENGLISH

**To store:** Disconnect hose from wands and canister to prevent stress on hose during storage. Store hose in a loosely coiled position so the hose covering is not stressed.

## POWER-MATE JR.® AND CADDY

### TO ATTACH CADDY

1. Align the tab on the wand with the slot in the Power-Mate Jr.® caddy.
2. Press the caddy onto the upper wand. The caddy will snap into place.

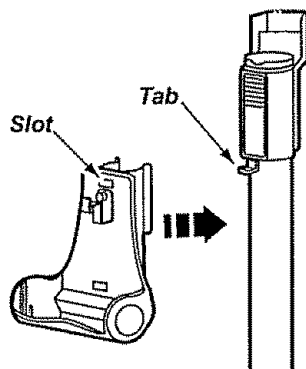

### TO INSERT POWER-MATE JR.®

1. Place the front of the Power-Mate Jr.® into the caddy.
2. Rotate the Power-Mate Jr.® back until it snaps into place.

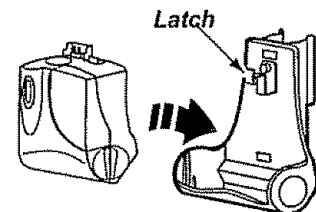

### TO REMOVE POWER-MATE JR.®

1. Press the latch and lift the Power-Mate Jr.® out of the caddy.



# USE

## HOW TO START



### WARNING

#### Personal Injury and Product Damage Hazard

- **DO NOT** plug in if switch is in **ON** position. Personal injury or damage could result.
- The cord moves rapidly when rewinding. Keep children away and provide a clear path when rewinding the cord to prevent personal injury.
- **DO NOT** use outlets above counters. Damage from cord to items in surrounding area could occur.

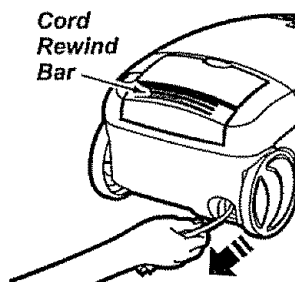

1. Pull cord out of canister to desired length. The cord will not rewind until the cord rewind bar is pushed.

**NOTE:** To reduce the risk of electric shock, this vacuum cleaner has a polarized plug; one blade is wider than the other. This plug will fit in a polarized outlet only one way. If the plug does not fit fully in the outlet, reverse the plug. If it still does not fit, contact a qualified electrician to install the proper outlet. Do not change the plug in any way.

2. Plug the polarized power cord into a 120 Volt outlet located near the floor.

**To rewind:** Unplug the cleaner. Hold the plug while rewinding to prevent damage or injury from the moving cord. Push cord rewind bar.

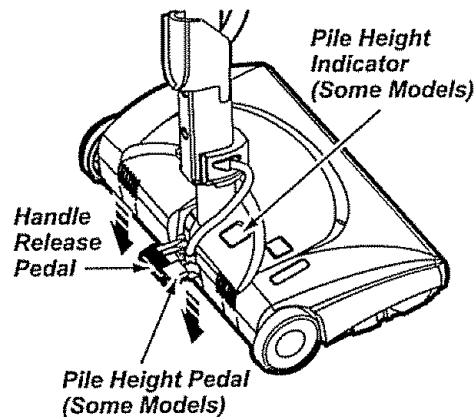
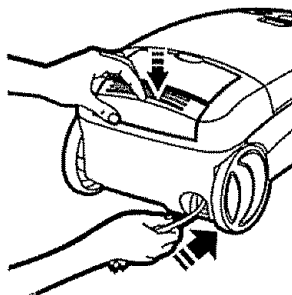

3. Lower wand from upright position by pressing on the handle release pedal.



### CAUTION

**DO NOT** leave the Power-Mate® running in one spot in the upright position for any length of time. Damage to carpet may occur.

4. Select a pile height setting by pressing the small pedal on the rear of the Power-Mate®. The pile height setting shows on the indicator. See SUGGESTED PILE HEIGHT SETTINGS.

**Attention:** Refer to your carpet manufacturers cleaning recommendations. Some more delicate carpets may require that they be vacuumed with the Power-Mate® agitator turned off, to prevent carpet damage.

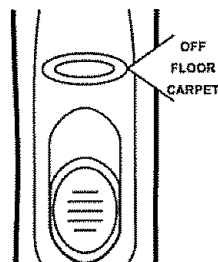

5. Select a switch position on the handle.

#### OFF

**FLOOR** - turns on the canister motor only.

**CARPET** - turns on both the canister and the Power-Mate® motors.

**NOTE** - When this switch is in the **FLOOR** position, the headlight and dirt sensor (some models) **DO NOT** function since no electricity flows to the Power-Mate®.

## VACUUMING TIPS

### Suggested sweeping pattern.

For best cleaning action, the Power-Mate® should be pushed straight away from you and pulled straight back. At the end of each pull stroke, the direction of the Power-Mate® should be changed to point into the next section to be cleaned. This pattern should be continued across the rug with slow, gliding motions.

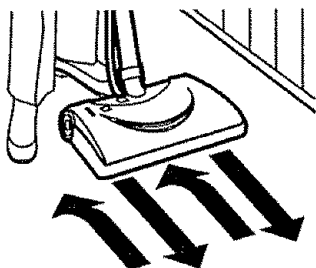

**NOTE:** Fast, jerky strokes do not provide complete cleaning.

The hose swivel allows the hose to turn without moving the canister. This is helpful for cleaning in small areas. Check hose for twisting before pulling canister.

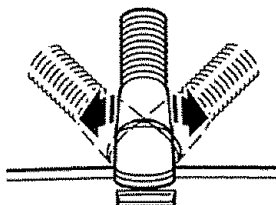

### CAUTION

#### Product Damage Hazard

Use care if the Power-Mate® and wand is left in the upright position as it may tip over easily. Property damage can occur if tipped.



### WARNING

#### Personal Injury and Product Damage Hazard

- **DO NOT** run over power cord with Power-Mate®. Personal injury or damage could result.
- **DO NOT** pull plug from wall by the power cord. If there is damage to the cord or plug, personal injury or property damage could result.

**Carpeted stairs** need to be vacuumed regularly. For best cleaning results, fully close the suction control.

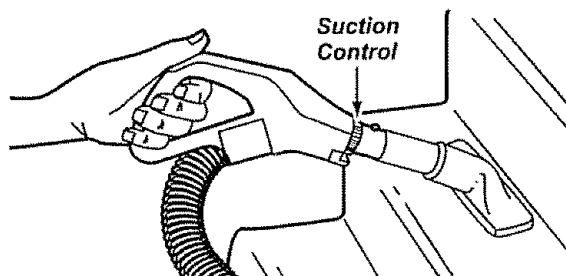

### WARNING

#### Personal Injury Hazard

Use care if canister is placed on stairs. If it falls, personal injury or property damage could result.

For best cleaning results, keep the airflow passage open. Check each assembly area in HOW YOUR VACUUM WORKS occasionally for clogs. **Unplug from outlet before checking.**

ENGLISH

## SUGGESTED PILE HEIGHT SETTINGS

For best deep down cleaning, use the **XLO** setting. However, you may need to raise the height to make some jobs easier, such as scatter rugs and some deep pile carpets, and to prevent the vacuum cleaner from shutting off. Suggested settings are:

**HI** – Shag, deep pile, or scatter rugs.

**MED** – Medium to deep pile.

**LO** – Low to medium pile.

**XLO** – Most carpets and bare floors.

## DIRT SENSOR

### SOME MODELS

The dirt sensor light system is mounted on the Power-Mate® nozzle near the reset button. It consists of a series of three red lights and one green light.

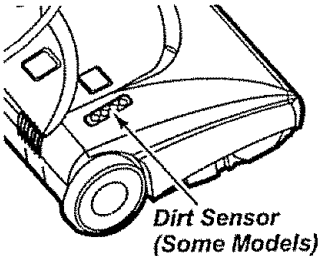

The lights give you an indication of the amount of dirt particles that are passing thru the sensor on its way to the dust bag.

### INITIAL START UP

When the Power-Mate® is first started, the following light sequences occurs in a two second time frame:

1. All three reds come on.
2. Two reds are on.
3. One red is on.
4. One green is on and will remain on until the Power-Mate® nozzle is placed in use.

**NOTE:** If the nozzle is on a surface that has dirt on it, dirt will be picked up by the vacuum and one or more red lights might stay on.

### IN OPERATION

When the Power-Mate® is being moved back and forth on the floor, the lights will change from one configuration to another as more dirt or less dirt is being vacuumed. As long as one or more red lights are on, dirt is passing through the wand to indicate that the surface still needs cleaning.

When the green light stays on as the Power-Mate® is moved back and forth over an area, the sensor is not seeing enough dirt to warrant further cleaning of that area.

**NOTE:** Dirt sensor lights **DO NOT** function in the **FLOOR** setting.

### CLEANING LENS

Although the dirt sensor feature in your Kenmore Power-Mate® is designed for years of trouble free use, the passage of dirt through the air passage system can coat the lens causing the green light to come on and stay on - never switching to red. When this happens the lens must be cleaned.

### TO CLEAN THE LENSES

1. Remove the wands by pressing the quick release pedal and lifting up on the wands.

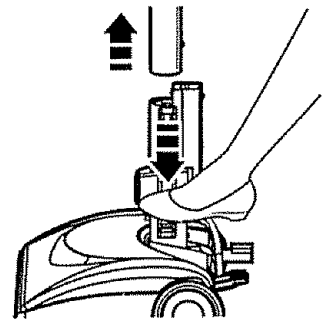

#### Cross Section View

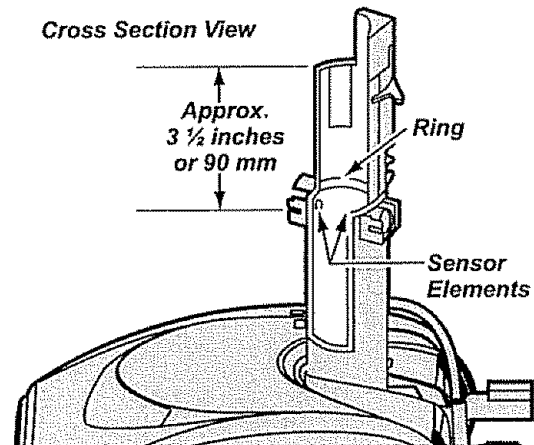

2. As indicated by the illustration, the two dirt sensor elements are located on the inside of the swivel, approximately 3 1/2 inches/90 mm down, (note the arrows). Each element should be cleaned periodically. To reach the sensor elements, use a small brush such as a bottle brush. Brush each sensor element several times to remove dust and dirt.

**NOTE:** Looking down inside the swivel you will see a ring. The sensor elements are located just slightly below this ring.

3. Reinstall the wands after cleaning the sensors.



### CAUTION

Never use water or any cleaning solution when cleaning the lenses. The residue of the water or cleaners will accelerate the recoating of the lenses and make cleaning necessary sooner.

# ATTACHMENTS



## CAUTION

DO NOT attach or remove handle or wands while cleaner is ON. This could cause sparking and damage the electrical contacts.

### ATTACHMENTS ON HANDLE

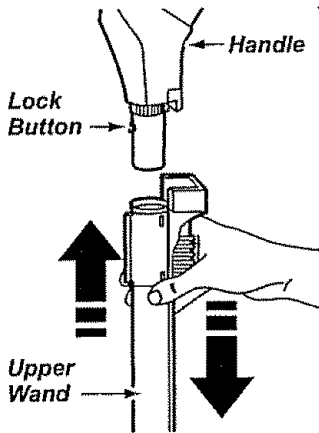

**NOTE:** If the Power-Mate® is attached, turn cleaner off before removing handle from wands.

1. Press lock button, then pull to remove handle from wand.

If your model has the optional feature of a handle release, press it in similarly.

2. Slide attachments firmly on handle as needed. See ATTACHMENT USE.

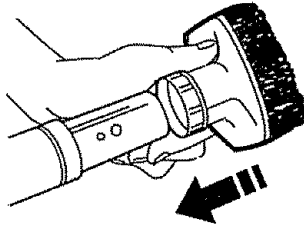

### ATTACHMENTS ON WANDS SOME MODELS

1. To remove wands from Power-Mate®, lock wands in straight-up position.

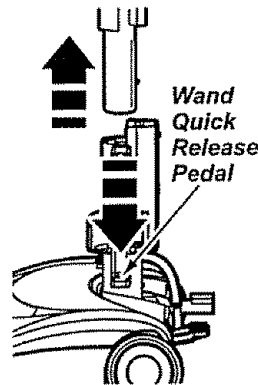
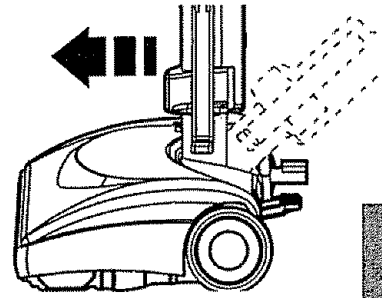

2. Press wand quick release pedal with foot and pull the wands straight up out of Power-Mate®.





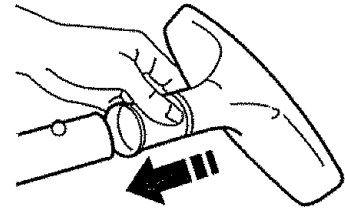

The Power-Mate® plug and cord do not have to be removed to use attachments on the wands.

3. Put attachments on wands as needed. See ATTACHMENT USE.

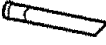

ENGLISH

## ATTACHMENT USE CHART

ATTACHMENT	CLEANING AREA						
	Furniture*	Between Cushions*	Drapes*	Stairs	Bare Floors	Carpeted Floors/Rugs	Walls
Dusting brush 	X		X				X
Crevice tool 	X	X					
Fabric brush 	X		X				
Floor brush (Some Models) 				X	X		X
Power-Mate® 					X**	X	
Handi-Mate Jr.® (Some Models)** 	X			X			
Power-Mate Jr.® (Some Models)** 	X			X			

\*Always clean attachments before using on fabrics. \*\* 3-way On/Off switch should be in FLOOR position.

\*\* Handi-Mate Jr.® and Power-Mate Jr.® attachment instructions are included with the products.

**NOTE:** When separating wands, depress lock button completely before pulling wands apart. If wand lock button is difficult to depress, push the two wands more tightly together to line up the lock button with the hole. Depress lock button and then pull wands apart.

## PERFORMANCE FEATURES

### EDGE CLEANER

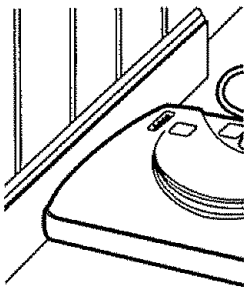

Active brush edge cleaners are on both sides of the Power-Mate®. Guide either side of the Power-Mate® along baseboards or next to furniture to help remove dirt trapped at carpet edges.

### OVERLOAD PROTECTOR

The Power-Mate® has built-in protection against motor and belt damage should the agitator jam. If the agitator slows down or stops, the overload protector shuts off the Power-Mate®. The canister motor will continue to run.

Overload Protector Reset Button

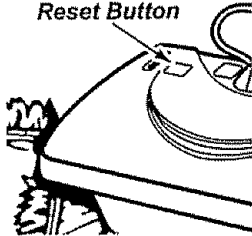

**To correct problem:** Turn off vacuum, remove obstruction, then press reset button.

**To reset:** Push in the overload protector button.

### SUCTION CONTROL

The suction control allows you to change the vacuum suction for different fabric and carpet weights. Opening the control decreases suction for draperies and lightweight rugs, while closing the control increases suction for upholsteries and carpets.

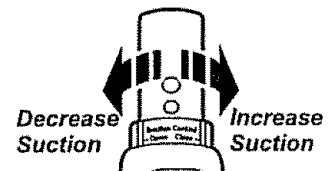

### WARNING

#### Personal Injury Hazard

Always unplug the vacuum cleaner before cleaning the agitator area as brush may suddenly restart. Failure to do so can result in personal injury.

## ELECTRONIC BAG/HOSE CHECK INDICATOR SOME MODELS

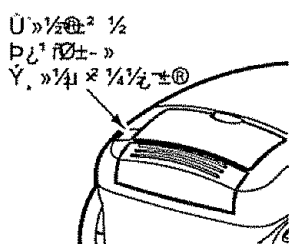

The light comes on whenever the airflow becomes blocked, dust bag needs changing or canister safety filter needs cleaning.

**NOTE:** The light may come on when using certain attachments, due to reduced airflow through attachment.

Refer to TROUBLESHOOTING.

## MECHANICAL BAG/HOSE CHECK INDICATOR SOME MODELS

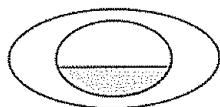

When the unit is running, the indicator window will be green if there are no clogs. When the indicator turns completely red there is a need to check the dust bag for being full or the other areas that may be clogged. See HOW YOUR VACUUM WORKS.

**NOTE:** Red may appear when using attachments or when cleaning new carpet, due to reduced airflow by the attachments themselves or new carpet fuzz filling the bag quickly.

## THERMAL PROTECTOR

This vacuum has a thermal protector which automatically trips to protect the vacuum from overheating. The thermal protector turns the motor off automatically to allow the motor to cool in order to prevent possible damage to the vacuum.

**To reset:** Turn off and unplug the vacuum from the outlet to allow the vacuum to cool. **Check for and remove any clogs. Also check and replace any clogged filters. Wait approximately 50 minutes and plug the vacuum in and turn back on to see if the thermal protector has reset. In some cases, the unit may suddenly restart. DO NOT leave unattended.**

## POWER-MATE® STORAGE SOME MODELS

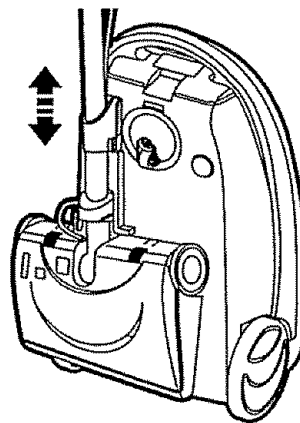

The lower wand has a "U" shaped flange in the area where the power cord attaches. The base has a "U" shaped slot near the front caster.

The flange allows the wands and Power-Mate® to be stored with the canister to conserve storage space. The canister must be stored on end for this feature to be used.

The wand will slip out of the slot as it is lifted up for use and will slide into the slot as it is lowered for storage.

The Power-Mate® must be in the flat position as shown in the illustration. Use the handle release pedal to place it in this position.

**NOTE:** You may save space by lowering the telescoping wand as shown in the ASSEMBLY section.



## CAUTION

To prevent tip over, never leave Power-Mate® on or in the upright position with the wand fully extended. Moving the wand to a lower position and turning the handle to one side will make the Power-Mate® more stable and less likely to tip over.

ENGLISH

## HOW YOUR VACUUM WORKS

The vacuum cleaner creates suction that picks up dirt. Rapidly moving air carries the dirt to the dust bag through the airflow passages. The dust bag lets the air pass through, while it traps the dirt.

For best cleaning results, keep the airflow passage open. Check the starred areas occasionally for clogs. Unplug from outlet before checking.

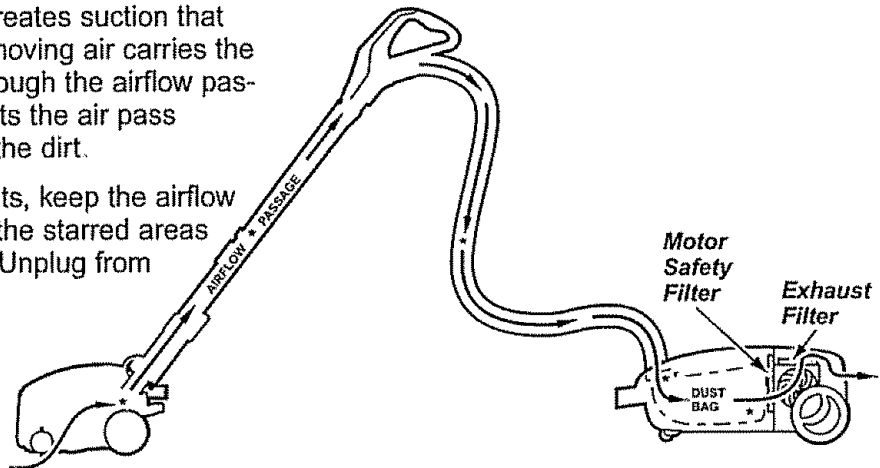

## CANISTER CARE

### BAG CHANGING

For best cleaning results, the dust bag should be changed often. The electronic/mechanical bag/hose check indicator will come on when the bag needs to be changed or the airflow is blocked.

**NOTE:** See PARTS AND FEATURES for Bag Number.

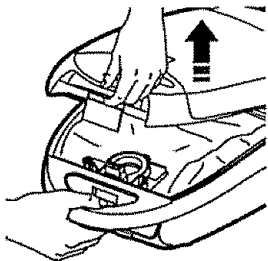

1. Unplug cord from wall outlet.
2. Remove hose from canister.
3. Pull hood release out and up, then lift canister hood.

4. Disengage cardboard tab from red bag mount by pulling away and lifting up.

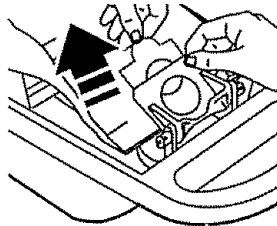

5. Pull bag out of the red bag mount.

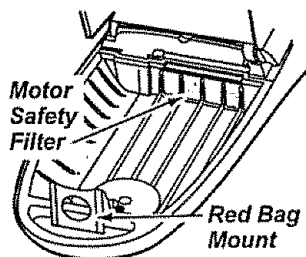

6. Check and replace, if necessary, the motor safety filter.

7. The red bag mount will flip forward after removing bag. This will prevent the lid from closing until a new bag is installed.

**Note:** DO NOT bend or crease the middle of the cardboard when installing the bag into the bag mount slots.

8. Rotate red bag mount down and install bag into slots per instructions pushing down until the cardboard tab locks into position and the holes align.

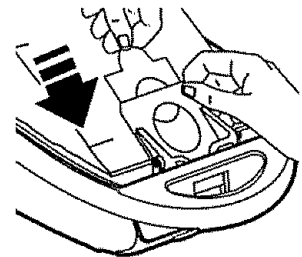

Tuck the bag securely into the bag cavity so that none of it is able to be pinched by the hood.

9. Close and latch canister hood.
10. Reinstall hose.
11. Plug cord into wall outlet.



### CAUTION

**NEVER REUSE A DUST BAG.** Very fine materials, such as carpet freshener, face powder, fine dust, plaster, soot, new carpet lint, etc. can clog the bag and cause it to burst before it is full and may cause damage to vacuum motor. Change bag more often when vacuuming these materials.

## CLEANING EXTERIOR AND ATTACHMENTS

1. Unplug cord from wall outlet. **DO NOT** drip water on cleaner.
2. Clean exterior using a clean, soft cloth that has been dipped in a solution of mild liquid detergent and water, then wrung dry. Wipe dry after cleaning.
3. To reduce static electricity and dust build-up, wipe outer surface of cleaner and attachments.



### CAUTION

Do not use attachments if they are wet. Attachments used in dirty areas, such as under a refrigerator, should not be used on other surfaces until they are washed. They could leave marks.

ENGLISH

## MOTOR SAFETY FILTER CHANGING

Check motor safety filter occasionally and change when dirty.



### WARNING

#### Electrical Shock Hazard

Unplug power cord from electrical outlet. Do not operate the cleaner without the motor safety filter. Be sure the filter is dry and properly installed to prevent motor failure and/or electrical shock.

Remove the bag as outlined in the BAG CHANGING section.

### MOTOR SAFETY FILTER ELECTROSTATIC

This white filter must be replaced when dirty. It should be replaced regularly depending on use conditions. **The filter CANNOT be washed as it will lose its dust trapping ability.**

**NOTE:** See PARTS AND FEATURES for motor safety filter number.

1. Lift the rubber retainer and pull out motor safety filter as shown.

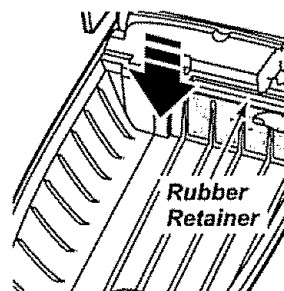
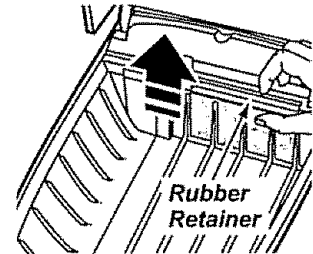

2. Replace the filter, **rough side out**, facing the dust bag, by sliding it back into place under the ribs in the bag cavity. Tuck filter in so that it fits completely under the rubber

retainer.

3. Replace the bag as outlined in the BAG CHANGING section.



### CAUTION

**NEVER REUSE A DUST BAG.** Very fine materials, such as carpet freshener, face powder, fine dust, plaster, soot, new carpet lint, etc. can clog the bag and cause it to burst before it is full. Change bag more often when vacuuming these materials.



## EXHAUST FILTER CHANGING



### WARNING

Fire and/or Electrical Shock Hazard  
Do not operate with a clogged exhaust filter or without the exhaust filter or exhaust filter cover installed.

### EXHAUST FILTER HEPA

The exhaust filter cartridge must be replaced when dirty. Replace the filter when the entire surface area is covered evenly. **The filter CANNOT be washed as it will lose its dust trapping ability.**

**NOTE:** See PARTS AND FEATURES for exhaust filter number.

1. Pull up on the exhaust filter cover to remove from the motor cover and lay aside.

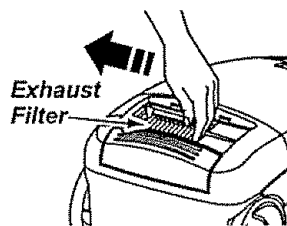
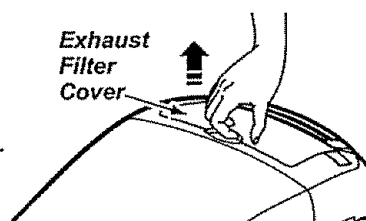

2. Slightly push the exhaust filter cartridge to the side, as shown in the illustration, and pull up to remove.

3. Replace the exhaust filter cartridge, carefully positioning it so that the side shown in the illustration goes down under the ribs. Then push the other side down until it snaps into place. Place the new filter into the motor cover with the **grey edge down**.

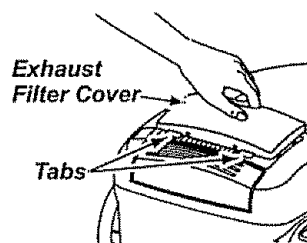
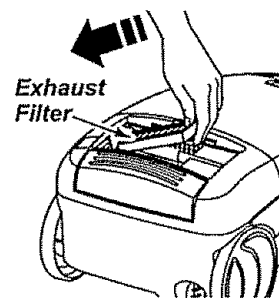

4. Replace the exhaust filter cover by engaging the two tabs on the rear and pushing down in front until it snaps closed.

## POWER-MATE® CARE

Always follow all safety precautions when cleaning and servicing the Power-Mate®.



### WARNING

Electrical Shock Or Personal Injury Hazard

Disconnect electrical supply before servicing or cleaning the unit. Failure to do so could result in electrical shock or personal injury from cleaner suddenly starting.

# BELT CHANGING AND AGITATOR CLEANING

## TO REMOVE BELT

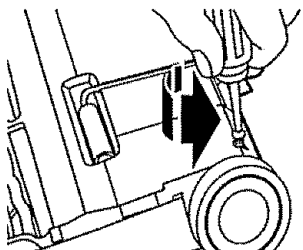

1. Turn Power-Mate® upside down.

2. Unscrew the two (2) Power-Mate® cover screws.

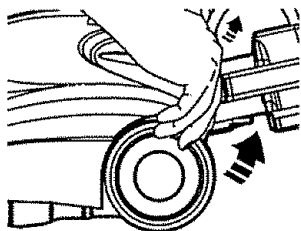

3. Turn Power-Mate® right side up. Press handle release pedal and lower the swivel. Lift rear latches up.

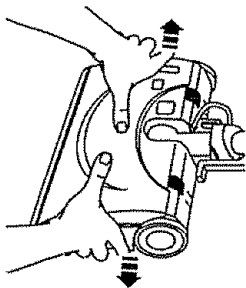

4. To remove cover, grasp the sides and pull out.

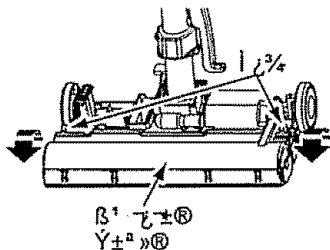

5. Depress tabs on rear of agitator cover and rotate forward to release from the Power-Mate® base.

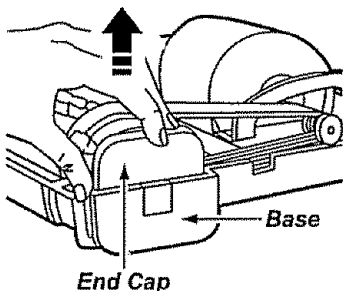

6. Lift agitator assembly out and remove worn belt.

7. Check and clean end cap areas. See AGITATOR ASSEMBLY for picture of complete agitator assembly.

## TO CLEAN AGITATOR:

**NOTE:** In order to keep cleaning efficiency high and to prevent damage to your vacuum, the agitator must be cleaned every time the belt is changed.

The agitator must also be cleaned according to the following schedule:

Vacuum Use	Clean Agitator
<b>HEAVY</b> - (used daily)	every week
<b>MODERATE</b> - (used 2-3 times/week)	every month
<b>LIGHT</b> - (used 1 time/week)	every 2 months

ENGLISH

## DISCONNECT CLEANER FROM ELECTRICAL OUTLET

Check and remove hair, string and lint build-up frequently in the Power-Mate® agitator and end cap areas.

Remove any dirt or debris in the belt path area or in the brush roller area.

Carefully remove any string or debris located on the agitator, or end caps.

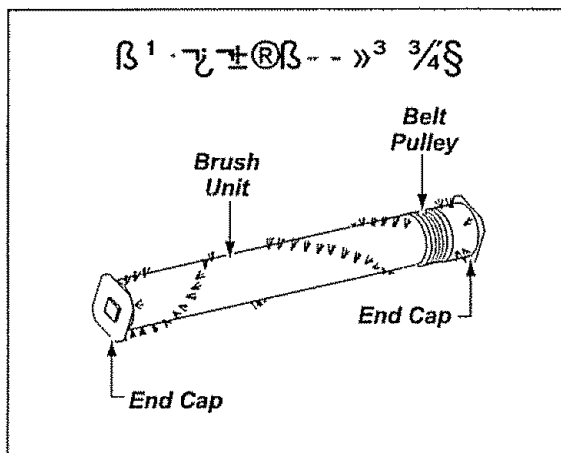

## TO REPLACE BELT

1. Install new belt over motor drive, then over brush sprocket.

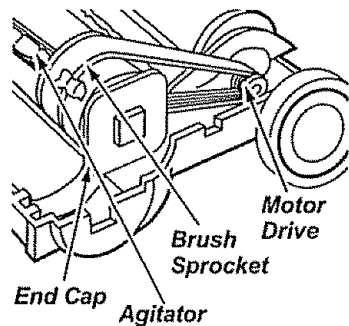

**NOTE:** See PARTS AND FEATURES for belt number.

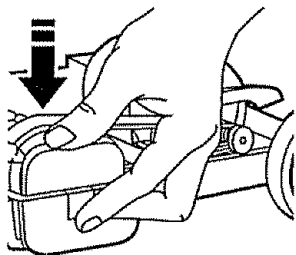

2. Place agitator assembly back into Power-Mate®.

3. Reinstall agitator cover by lining up the front tabs and slots and rotating downward until the latches snap into place.

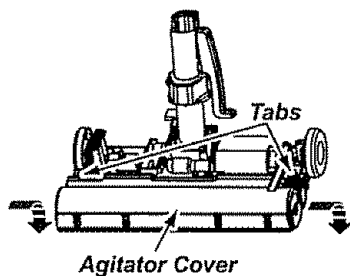

4. Line up front of cover and base. Rest cover on front edge of base as shown.

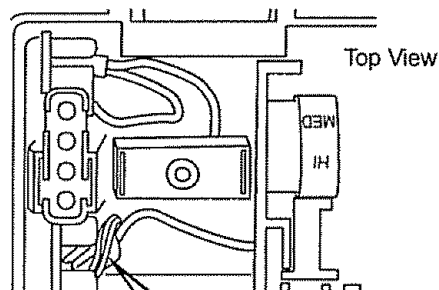
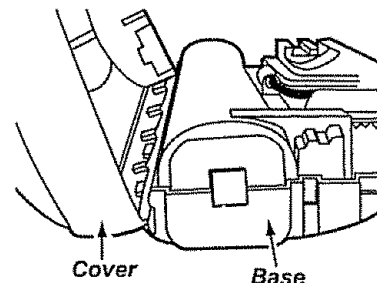

**5. NOTE:** On dirt sensor models be sure that the board is upright and the wires are tucked back as shown.

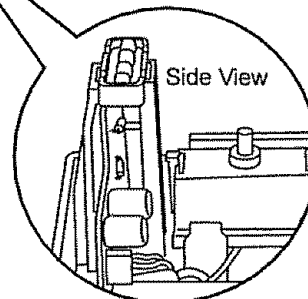

6. Rotate cover back. Press cover firmly until side and rear tabs snap into place. Turn Power-Mate® upside down and replace two (2) cover screws.

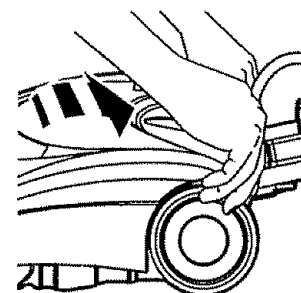

## LIGHT BULB CHANGING

1. Remove Power-Mate® cover as shown in BELT CHANGING AND AGITATOR CLEANING section.

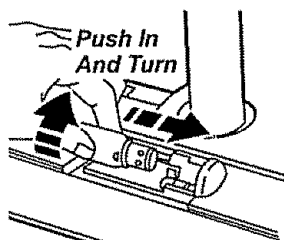

2. Push in and turn bulb counterclockwise, then pull out to remove.

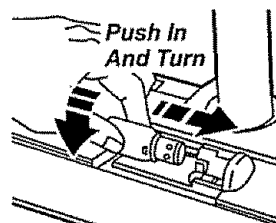

3. Push in and turn bulb clockwise, to replace. Bulb must not be higher than 15 Watts (130 Volts).

4. Reinstall Power-Mate® cover as shown in BELT CHANGING AND AGITATOR CLEANING section.

**NOTE:** See PARTS AND FEATURES for bulb number.

## AGITATOR SERVICING



### WARNING

Electrical Shock Or Personal Injury Hazard

Disconnect electrical supply before servicing or cleaning the unit. Failure to do so could result in electrical shock or personal injury from cleaner suddenly starting.

### TO CHECK AGITATOR ASSEMBLY

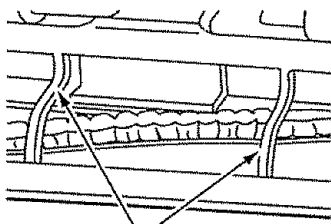

*Base Support Bars*

When brushes are worn to the level of the base support bars, replace the agitator assembly.

### TO REPLACE AGITATOR ASSEMBLY

1. Remove Power-Mate® cover, belt and agitator assembly. See "To Remove Belt" in BELT CHANGING AND AGITATOR CLEANING.
2. Replace Agitator
3. Replace belt, agitator assembly, Power-Mate® cover, light bulb and light cover. See "To replace belt" in BELT CHANGING AND AGITATOR CLEANING.

ENGLISH

Review this table to find do-it-yourself solutions for minor performance problems. Any service needed, other than those described in this owner's manual, should be performed by an authorized Sears Service Center.



Cleaner won't start.	<ol style="list-style-type: none"> <li>1. Unplugged at wall outlet.</li> <li>2. Tripped circuit breaker/blown fuse at household service panel</li> <li>3. Loose hose electrical connections.</li> </ol>	<ol style="list-style-type: none"> <li>1. Plug in firmly, push ON/OFF switch to ON</li> <li>2. Reset circuit breaker or replace fuse</li> <li>3. Reconnect hose ends, (page 7).</li> </ol>
Poor job of dirt pick-up.	<ol style="list-style-type: none"> <li>1. Full or clogged dust bag</li> <li>2. Clogged airflow passages.</li> <li>3. Dirty filters</li> <li>4. Wrong pile height setting</li> <li>5. Open suction control.</li> <li>6. Hole in hose</li> <li>7. Worn Power-Mate<sup>®</sup> agitator.</li> <li>8. Worn or broken belt</li> <li>9. Dirty agitator or end caps</li> <li>10. Canister hood open.</li> </ol>	<ol style="list-style-type: none"> <li>1. Change bag. (page 14)</li> <li>2. Clear airflow passages, (page 14)</li> <li>3. Change filters, (page 15-16).</li> <li>4. Adjust setting, (page 9).</li> <li>5. Adjust control, (page 12)</li> <li>6. Replace hose</li> <li>7. Change agitator, (page 19).</li> <li>8 &amp; 9. See BELT CHANGING AND AGITATOR CLEANING. (pages 17-18)</li> <li>10. Close and latch hood.</li> </ol>
Cleaner starts but cuts off.	<ol style="list-style-type: none"> <li>1. Hose or hood electrical connections.</li> <li>2. Tripped overload protector in Power-Mate<sup>®</sup></li> <li>3. Tripped overload protector in canister</li> </ol>	<ol style="list-style-type: none"> <li>1. Check connections, reconnect hose ends. (page 7)</li> <li>2. Remove any items that may be caught or jammed, then reset. If cleaner starts and stops again, clean agitator and end caps, then reset, (pages 12, 17-18).</li> <li>3. Turn off and unplug the vacuum from outlet and wait approximately 50 minutes and plug the vacuum in, turn back on to see if the protector has reset. (page 13) Change dust bag, clear airflow blockage, (page 14)</li> </ol>
POWER-MATE <sup>®</sup> will not run when attached.	<ol style="list-style-type: none"> <li>1. Power-Mate<sup>®</sup> connections unplugged</li> <li>2. Worn or broken belt.</li> <li>3. Dirty agitator or end caps</li> <li>4. Tripped overload protector in Power-Mate<sup>®</sup></li> <li>5. Switch not in CARPET position.</li> </ol>	<ol style="list-style-type: none"> <li>1. Plug in firmly, (page 6)</li> <li>2 &amp; 3. See BELT CHANGING AND AGITATOR CLEANING, (pages 17-18)</li> <li>4. Check agitator area for excessive lint build-up or jamming. Clean agitator and end caps, then reset, (pages 12, 17-18).</li> <li>5. Move switch to CARPET position, (page 8).</li> </ol>
Constant green light on in dirt sensor.	<ol style="list-style-type: none"> <li>1. Dirt passage is clogged.</li> <li>2. Lenses are dirty.</li> </ol>	<ol style="list-style-type: none"> <li>1. Check for clogs in air passages, (page 14)</li> <li>2. Clean lenses, (page 10)</li> </ol>
Any, some, or all red lights in dirt sensor burn and never turn green.	<ol style="list-style-type: none"> <li>1. Dirt passage is clogged.</li> </ol>	<ol style="list-style-type: none"> <li>1. Check for clogs in air passages, (page 14).</li> </ol>
No green or red dirt sensor lights.	<ol style="list-style-type: none"> <li>1. Switch not in CARPET position.</li> <li>2. No power to sensor board.</li> </ol>	<ol style="list-style-type: none"> <li>1. Move switch to CARPET position, (page 8).</li> <li>2. Take to your nearest Sears Service Center.</li> </ol>
Electronic/Mechanical Bag/Hose Check Indicator activates.	<ol style="list-style-type: none"> <li>1. Full or clogged dust bag</li> <li>2. Dirty filters</li> <li>3. Blocked airflow passage</li> <li>4. Certain attachment tools</li> </ol>	<ol style="list-style-type: none"> <li>1. Change bag. (page 14).</li> <li>2. Change filters. (page 15-16).</li> <li>3. Clear blockage from airflow passage, (page 14).</li> <li>4. This is normal. Light should go off when tool is removed.</li> </ol>
Cleaner picks up moveable rugs -or- POWER-MATE <sup>®</sup> pushes too hard.	<ol style="list-style-type: none"> <li>1. Wrong pile height setting</li> <li>2. Suction too strong.</li> </ol>	<ol style="list-style-type: none"> <li>1. Adjust setting, (page 9)</li> <li>2. Open suction control. (page 12).</li> </ol>
Light won't work.	<ol style="list-style-type: none"> <li>1. Burned out light bulb.</li> </ol>	<ol style="list-style-type: none"> <li>1. Change light bulb, (page 18).</li> </ol>
Cord won't rewind.	<ol style="list-style-type: none"> <li>1. Dirty power cord</li> <li>2. Cord jammed</li> </ol>	<ol style="list-style-type: none"> <li>1. Clean the power cord</li> <li>2. Pull out cord and rewind</li> </ol>
Cleaner leaves marks on carpet.	<ol style="list-style-type: none"> <li>1. Wrong vacuuming pattern</li> </ol>	<ol style="list-style-type: none"> <li>1. See VACUUMING TIPS, (page 9)</li> </ol>

# Get it fixed, at your home or ours!

## Your Home

For repair - **in your home** - of **all** major brand appliances, lawn and garden equipment, or heating and cooling systems, **no matter who made it, no matter who sold it!**

For the replacement parts, accessories and owner's manuals that you need to do-it-yourself.

For Sears professional installation of home appliances and items like garage door openers and water heaters.

**1-800-4-MY-HOME<sup>®</sup>** Anytime, day or night  
(1-800-469-4663) (U.S.A. and Canada)

[www.sears.com](http://www.sears.com) [www.sears.ca](http://www.sears.ca)

## Our Home

For repair of carry-in products like vacuums, lawn equipment, and electronics, call or go on-line for the nearest **Sears Parts and Repair Center.**

**1-800-488-1222** Anytime, day or night (U.S.A. only)

[www.sears.com](http://www.sears.com)

To purchase a protection agreement (U.S.A.) or maintenance agreement (Canada) on a product serviced by Sears:

**1-800-827-6655** (U.S.A. )

**1-800-361-6665** (Canada )

Para pedir servicio de reparación a domicilio, y para ordenar piezas:

**1-888-SU-HOGAR<sup>SM</sup>**  
(1-888-784-6427)

Au Canada pour service en français:

**1-800-LE-FOYER<sup>MC</sup>**  
(1-800-533-6937)  
[www.sears.ca](http://www.sears.ca)

# SEARS

© Sears, Roebuck and Co.

® Registered Trademark / <sup>TM</sup> Trademark / <sup>SM</sup> Service Mark of Sears, Roebuck and Co.

® Marca Registrada / <sup>TM</sup> Marca de Fábrica / <sup>SM</sup> Marca de Servicio de Sears, Roebuck and Co.

<sup>MC</sup> Marque de commerce / <sup>MD</sup> Marque déposée de Sears, Roebuck and Co.