

This Owner's Manual is provided and hosted by [Appliance Factory Parts](#).



DE'LONGHI ESAM3500-N EZ:D Owner's Manual

[Shop genuine replacement parts for DE'LONGHI
ESAM3500-N EZ:D](#)



[Find Your DE'LONGHI Coffee Maker Parts - Select From 289 Models](#)

----- Manual continues below -----



**IMPORTANT INSTRUCTIONS
SAVE THESE INSTRUCTIONS**

**MODE D'EMPLOI IMPORTANT
CONSERVEZ LES PRESENTES INSTRUCTIONS**

**INSTRUCCIONES IMPORTANTES
REPASE Y GUARDE ESTAS INSTRUCCIONES
LEA ESTE INSTRUCTIVO ANTES DE UTILIZAR EL APARATO**

**ISTRUZIONI IMPORTANTI
CONSERVARE LE ISTRUZIONI**

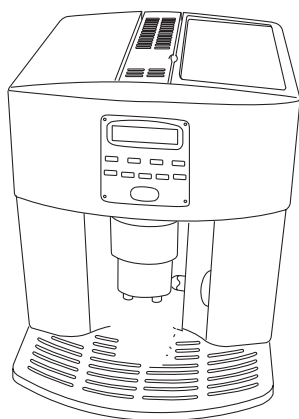

**COFFEE MAKER TYPE ESAM3500/CAFETERIE MODÈLE ESAM3500/
CAFETERA ELECTRICA MODELO ESAM3500/ MACCHINA DA CAFFÈ ESAM3500**

Register this product on-line and receive a free trial issue of Cook's Illustrated. Visit <http://registration.delonghi-csservice.com>. Visit www.delonghi.com for a list of service centers near you. (U.S. and Canada only)

Enregistrez ce produit en ligne et recevez un numéro gratuit de Cook's Illustrated. Visitez <http://registration.delonghi-csservice.com>. Visitez www.delonghi.com pour y voir une liste des centres de réparation proches de chez vous. (É.-U. et Canada).

Registre este producto en línea y reciba un ejemplar gratis de Cook's Illustrated. Visite <http://registration.delonghi-csservice.com>. Visite www.delonghi.com para ver la lista de centros de servicios cercanos a usted. (Estados Unidos y Canada)

Registra questo prodotto "on-line" per ricevere una copia omaggio della rivista. Visita <http://registration.delonghi-csservice.com>. Visita www.delonghi.com per una lista dei centri di servizio a te più vicini. (Stati Uniti e Canada)

**ELECTRONIC CHARACTERISTICS: CARACTÉRISTIQUES ÉLECTRIQUES: CARACTERISTICAS ELECTRICAS:
CARATTERISTICHE ELETTRICHE: 120V~60HZ 1350W**

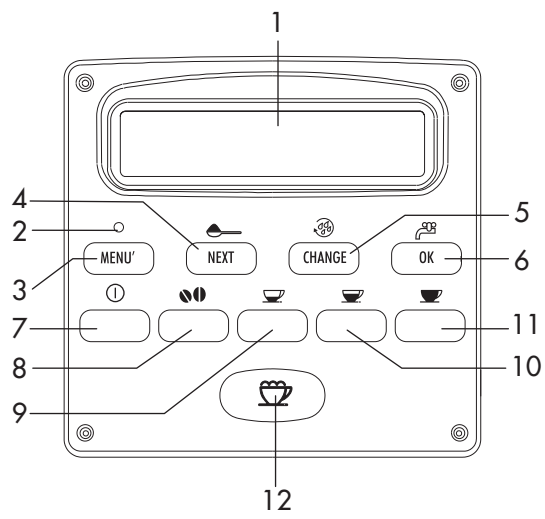
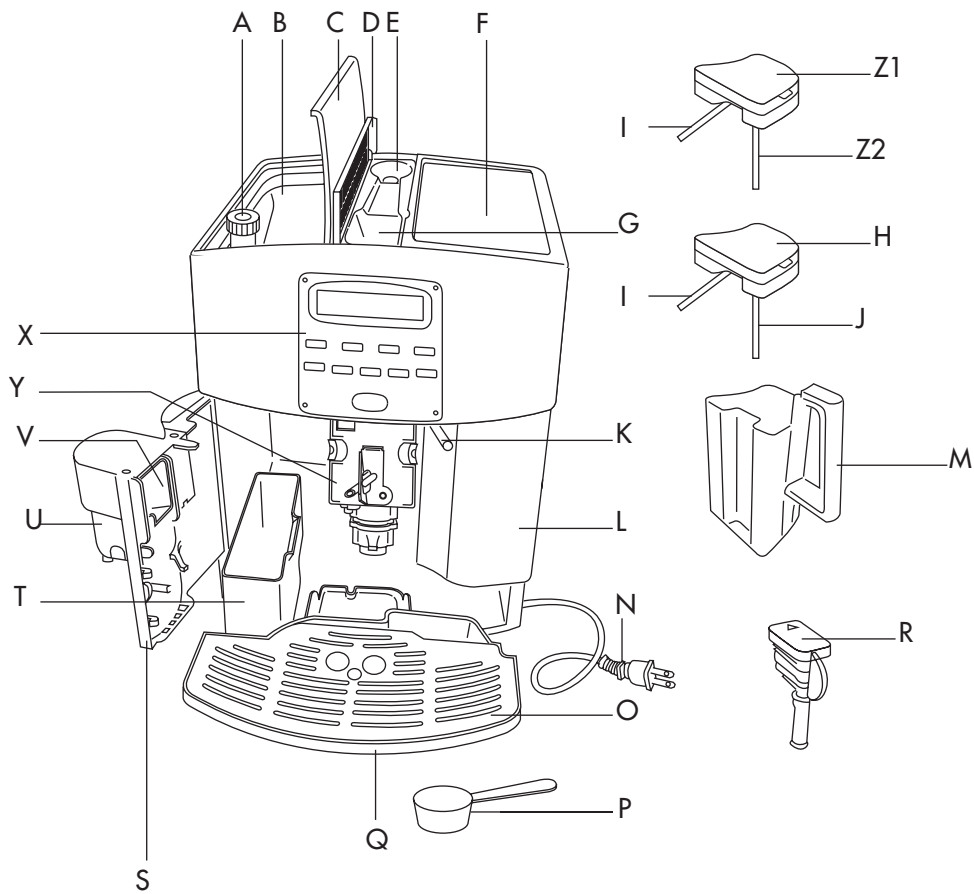

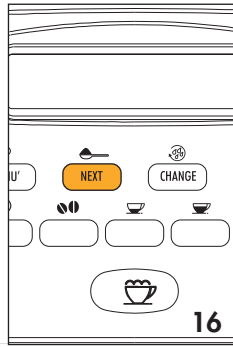
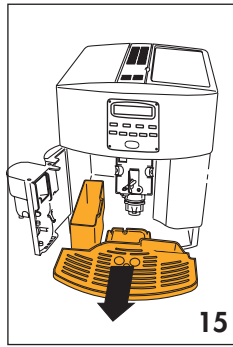
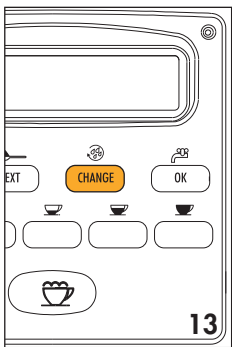
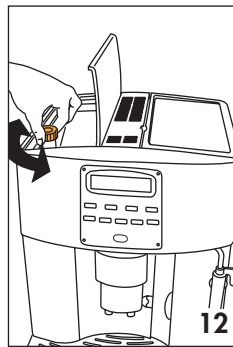
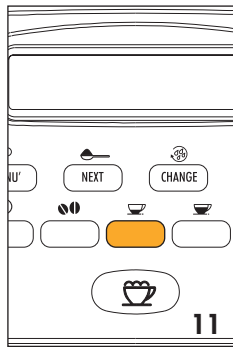
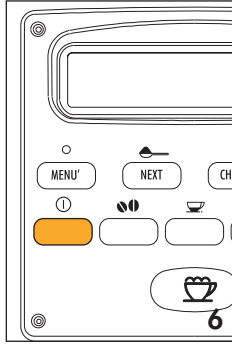
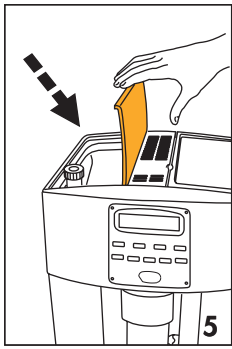
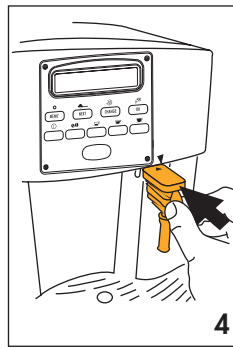
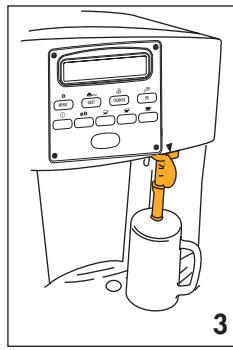
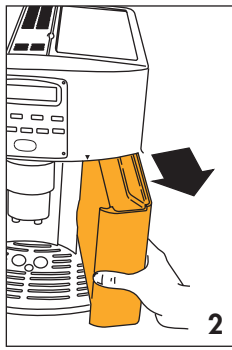
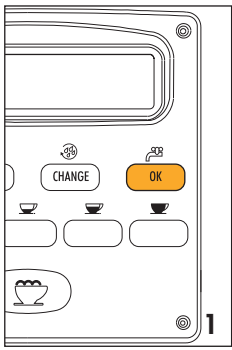

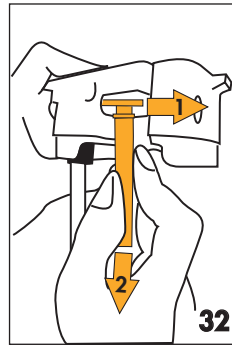
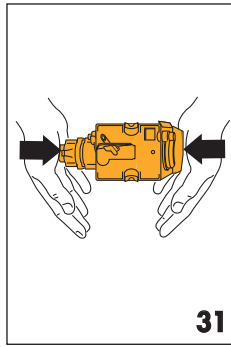
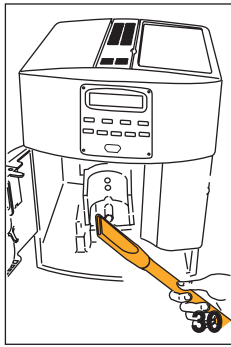
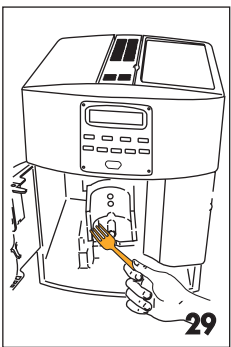
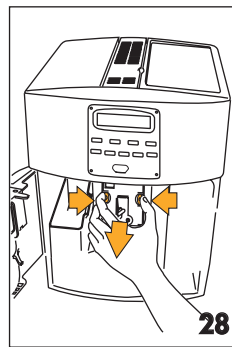
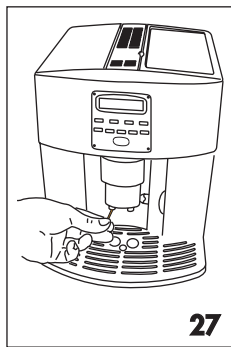
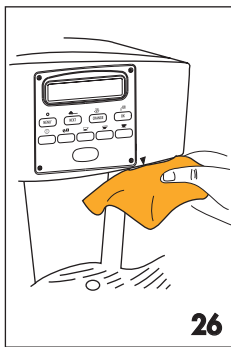
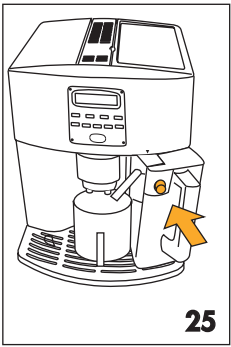
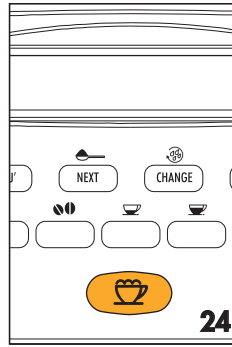
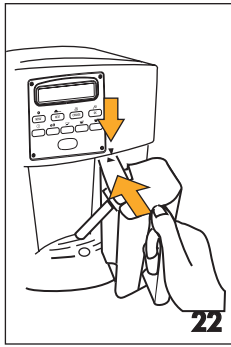
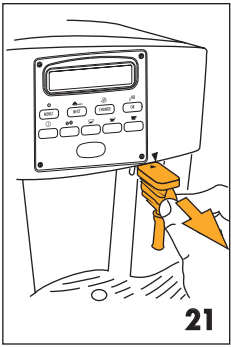
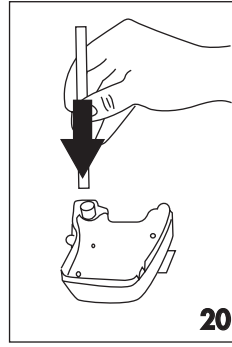
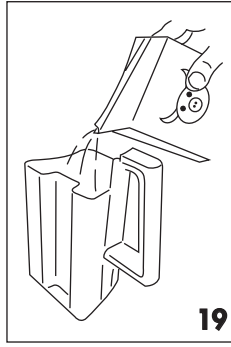
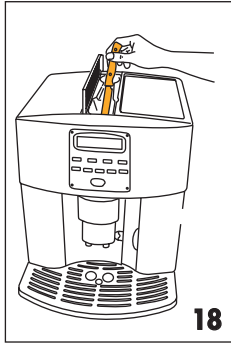
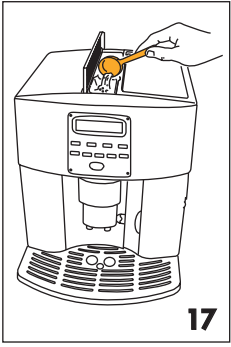



De'Longhi America, Inc.
Park 80 West, Plaza One
Saddle Brook, NJ 07663
#1-866-Latte-Best
1-866-528-8323

De'Longhi Canada, Inc.
6150 McLaughlin Road
Mississauga, Ontario
L5R 4E1 Canada
#1-866-Latte-Best
1-866-528-8323

FIDUCIA ITALIANA S.A DE C.V
Pestalozzi #814
Col. Narvarte
Del. Benito Juarez
C.P. 03100
tels: 5543 1447
lada sin costo: 01 800 711 8805

www.delonghi.com

Coffee has been used to factory test the appliance and it is, therefore, completely normal for there to be traces of coffee in the mill. This appliance is, however, guaranteed to be new.

INDEX

IMPORTANT SAFEGUARDS	7
1 DESCRIPTION OF THE APPLIANCE (see page 3)	8
2 SAFETY WARNINGS	8
3 INSTALLATION	9
4 USING FOR THE FIRST TIME	9
5 TURNING ON AND PREHEATING	10
6 PREPARING COFFEE (USING COFFEE BEANS)	10
7 CHANGING THE QUANTITY OF COFFEE IN THE CUP	12
8 REGULATING THE COFFEE MILL	12
9 PREPARING ESPRESSO/COFFEE WITH PRE-GROUND COFFEE (INSTEAD OF BEANS)	13
10 PRODUCING HOT WATER	13
11 CHANGING THE QUANTITY OF HOT WATER	14
12 PREPARING CAPPUCCINOS OR LATTE (MILK WITH COFFEE)	14
13 PREPARING FROTHED MILK (WITHOUT COFFEE)	15
14 CHANGING THE QUANTITY OF COFFEE AND MILK FOR CAPPUCCINOS	15
15 CLEANING AND MAINTENANCE	15
15.1 CLEANING THE COFFEE MAKER	15
15.2 CLEANING THE INFUSER	16
15.3 CLEANING THE MILK CONTAINER	17
16 CHANGING AND SETTING THE MENU PARAMETERS	17
16.1 SETTING THE CLOCK	17
16.2 SETTING AUTO-START TIME	17
16.3 DESCALING	18
16.4 CHANGING COFFEE TEMPERATURE	19
16.5 CHANGING THE LENGTH OF TIME THE APPLIANCE REMAINS ON	19
16.6 SETTING WATER HARDNESS	19
16.7 RESETTNG FACTORY DEFAULT SETTINGS	20
17 CHANGING THE LANGUAGE	20
18 TROUBLESHOOTING	20
19 PROBLEMS THAT CAN BE RESOLVED BEFORE CALLING THE SERVICE CENTER	21
LIMITED WARRANTY	23

IMPORTANT SAFEGUARDS

When using electrical appliances, basic safety precautions should always be followed, including the following:

- Read all instructions.
- Do not touch hot surfaces. Use handles and knobs.
- To protect against fire, electrical shock and personal injury, do not immerse cord, plug or appliance in water or other liquid.
- Never allow the appliance to be used by children.
- Unplug from the outlet when not in use and before cleaning. Allow to cool before fitting or taking off parts, and before cleaning the appliance.
- Do not operate with a damaged cord or plug, or after the appliance malfunctions, or has been damaged in any manner. Return the appliance to the nearest authorized service facility for examination, repair or adjustment.
- The use of accessory attachments or spare parts not recommended by the appliance manufacturer may result in fire, electrical shock or personal injury.
- Do not use outdoors.
- Do not let the cord hang over the edge of the table or counter, or touch hot surfaces.
- Do not place on or near a hot gas or electrical burner, or in a heated oven.
- Plug cord into the wall outlet. To disconnect, turn any control to "off", then remove plug from wall outlet.
- Do not use the appliance for other than the intended use. This appliance is to be utilized for domestic use only. Any other use is to be considered improper and therefore, dangerous.

WARNING: To reduce the risk of fire or electric shock, do not remove the cover.

No user serviceable parts inside. Repair should be done by authorized service personnel only!

SAVE THESE INSTRUCTIONS

THIS PRODUCT IS FOR HOUSEHOLD USE ONLY

SHORT CORD INSTRUCTIONS

- A short power cord is provided to reduce risks resulting from becoming entangled in or tripping over a longer cord.
- Longer, detachable power supply cords or extension cords are available and may be used if care is exercised in their use.
- If an extension cord is used, the marked electrical rating should be at least as great as the electrical rating of the appliance. If the appliance is provided with 3-wire, grounding type cord, the extension should be a GROUNDING TYPE 3 - WIRE CORD. The longer cord should be arranged so that it will not drape over the counter-top or table top where it can be pulled on by children or tripped over.
- Your product is equipped with a polarized alternating current line plug (a plug having one blade wider than the other). This plug will fit into the power outlet only one way. This is a safety feature. If you are unable to insert the plug fully into the outlet, try reversing the plug. If the plug should still fail to fit, contact your electrician to replace your obsolete outlet. Do not defeat the safety purpose of the polarized plug.

1 DESCRIPTION OF THE APPLIANCE (SEE PAGE 3)

- | | |
|---|---|
| A. Grinding coarseness regulator | Z. Milk intake tube for lid with the wording "STEAMED MILK – LATTE" |
| B. Coffee bean container | |
| C. Bean container lid | Control Panel |
| D. Central lid for ground coffee | 1. Display |
| E. Compartment for measuring scoop | 2. MENU light |
| F. Cup warmer tray | 3. Button to activate or deactivate menu parameter setting mode |
| G. Ground coffee funnel | 4. Button to select ground coffee or, if the MENU light is on, to display the next parameter on the menu |
| H. Milk container lid with the wording "FROTHED MILK - CAPPUCCINO" | 5. Button to rinse the appliance or, if the MENU light is on, to change the menu parameters |
| I. Milk spouts | 6. Button to select hot water or, if the MENU light is on, to confirm the menu parameters |
| J. Milk intake tube for lid with the wording "FROTHED MILK – CAPPUCCINO" | 7. Appliance ON/OFF button |
| K. Nozzle | 8. Coffee strength selection button |
| L. Water tank (removable) | 9. One or two cups short coffee button |
| M. Milk container | 10. One or two cups normal coffee button |
| N. Power cable | 11. One or two cups long coffee button |
| O. Cup tray | 12. Single Touch Cappuccino - Latte button |
| P. Measuring scoop for pre-ground coffee | |
| Q. Drip tray (removable) | |
| R. Hot water spout | |
| S. Service door | |
| T. Coffee grounds container (removable) | |
| U. Coffee spout (adjustable in height) | |
| V. Mobile drawer | |
| W. Infuser | |
| X. Control panel | |
| Y. Milk container lid with the wording "STEAMED MILK – LATTE" | |

2 SAFETY WARNINGS

READ THESE INSTRUCTIONS CAREFULLY AND KEEP FOR FUTURE CONSULTATION!

- This appliance is designed to "make espresso coffee" and "hot drinks". Use with care to avoid scalds from the water and steam jets or through incorrect use.
- This appliance is intended for domestic use only. Any other use is considered improper and thus dangerous.
- The manufacturer cannot be held responsible for any damage caused through incorrect, wrong or unreasonable use.
- When using the appliance, do not touch the hot surfaces.
- Never touch the appliance with wet or damp hands or feet.
- The appliance is not intended for use by young children or infirmed persons without supervision.
- Never allow children to play with the appliance.
- In the event of failure or malfunction, unplug the appliance from the outlet and do not tamper with it in any way. If it requires repair, contact an authorized service center only and ask for original spare parts to be used. Failure to respect the above could reduce the safety of the appliance.

3 INSTALLATION

- After unpacking, make sure the appliance is complete and undamaged. If in doubt, do not use it. Contact professionally qualified personnel.
- The packing elements (plastic bags, polystyrene foam, etc.) should be kept out of the reach of children as they are a safety hazard.
- Place the appliance on a work surface far away from water taps, basins and sources of heat.
- After positioning the appliance on the work top, leave a space of at least 2 in. between the surfaces of the appliance and the side and rear walls and at least 8 in. above the coffee maker.
- Never install the appliance in environments where the temperature may be freezing (the appliance could be damaged if the water freezes).
- Connect the appliance to a grounded socket with a minimum current rating of 10 amps. The manufacturer is not liable for possible accidents caused by failure to do so.
- If the power socket does not match the plug on the appliance, have the socket replaced with a suitable type by a qualified professional.
- The power cable on this appliance must not be replaced by the user as this operation requires the use of special tools.
If the cable is damaged or requires replacing, contact an authorized service center only to avoid all risks.
- You should personalize water hardness as soon as possible following the instructions in section 16.6.

To correctly learn how to use the appliance, when starting it for the first time, carefully follow the step-by-step instructions described in the following paragraphs.

4 USING FOR THE FIRST TIME

1. The first time you use the appliance, select the language.

To set English, plug the appliance into the outlet and wait for the following message to be displayed:

PRESS OK TO INSTALL ENGLISH

While the message is displayed, press the **OK** button (fig. 1) for at least three seconds until the display shows:

ENGLISH INSTALLED

The appliance then displays the setting message in English. If you select the wrong language by mistake, follow the instructions in section 17 to choose the right one.

2. After 5 seconds, the appliance displays:

FILL TANK

To fill, remove the tank (fig. 2), rinse and fill with fresh water. Never exceed the MAX line.

Put the tank back and push as far as it will go.

3. Place a cup under the hot water spout (fig. 3). (If the water spout is not in place, INSERT WATER SPOUT is displayed. Attach it as shown in figure 4, making sure the arrow on the spout is lined up with the arrow on the control panel of the appliance, fig. 4). The appliance now displays:

PRESS OK

4. Press the OK button (fig. 1) and after a few seconds, a little water will run from the spout (running water stops automatically).

5. The appliance displays:

TURNING OFF PLEASE WAIT

and it goes off.

6. Fill the coffee bean container with coffee beans (fig. 5).

IMPORTANT: to prevent malfunction, never fill with ground coffee, freeze dried coffee, caramelized beans or anything else which could damage the appliance.

5 TURNING ON AND PREHEATING

1. Press the  button (fig. 6). The appliance displays:

HEATING UP PLEASE WAIT...

to indicate preheating is underway.

2. Once preheating is completed, the appliance displays

RINSING PLEASE WAIT...

and performs an automatic rinse cycle (a little hot water runs from the spouts and is collected in the drip tray below).

Tip: if you want a short coffee (less than 2 oz), to make it hotter, fill the cup with this hot rinsing water first. Leave it for a few seconds then empty it to preheat the cup.



8. The appliance now displays the ready message:

READY REGULAR TASTE

6 PREPARING COFFEE (USING COFFEE BEANS)

1. The appliance is preset to make coffee with a regular taste. You can also choose coffee with an extra-mild, mild, strong or extra-strong taste. To choose the required taste, press the  button (fig. 7). The selected coffee taste will be displayed.

2. Place 1 cup under the spouts to make 1 coffee (fig. 8) or 2 cups for 2 coffees (fig. 9). For a creamier coffee, lower the spouts to bring them as close to the cups as possible (Fig. 10).

3. Press the  button to make a short coffee (fig. 11), the  button for a normal coffee or the  button for a long coffee.

To make 2 coffees, press the button twice (within 2 seconds).

To change the quantity of coffee delivered automatically into the cup, follow the instructions in section 7.

(The appliance now grinds the beans and starts brewing the coffee into the cup.

Once the desired quantity has been reached, the appliance automatically stops delivering the coffee and ejects the grounds into the coffee grounds container).

4. After a few seconds, the ready message is displayed again and you can make another coffee.

5. To turn the appliance off, press the  button.

Before going off, the appliance performs an automatic rinse cycle (a little hot water runs out from the spouts and is collected in the drip tray beneath. Take care to avoid scalds).

NOTE 1: If the coffee is delivered a drop at a time or not at all, turn the grinding coarseness regulator (fig. 12) one click clockwise (see section 8).

Turn one click at a time until the coffee is delivered adequately. The grinding coarseness regulator must only be turned when the coffee mill is running.



NOTE 2: If the coffee is delivered too fast and is not creamy enough, turn the grinding coarseness regulator (fig. 12) one click counterclockwise (see section 8).

Avoid turning the grinding coarseness regulator excessively otherwise when you select 2 cups, the coffee may run out in drips. The grinding coarseness regulator must only be turned when the coffee mill is running.

NOTE 3: *Tips to make hotter coffee:*

- When you turn the appliance on, if you want to make a short coffee (less than 2 oz), use the hot rinse-through water to preheat the cups.
If 2 to 3 minutes have passed since you last made coffee, before making coffee again you must preheat the infuser by pressing the  button (fig. 13).
Run off the water into the underlying drip tray or alternatively use this water to fill (and then empty) the cup to be used for the coffee, so as to preheat it.
- Unless preheated, do not use cups that are too thick, as they will absorb too much heat.
- Use cups that have been preheated by rinsing them with hot water or by leaving them for at least 20 minutes on the cup warmer tray on top of the appliance with the appliance on.

NOTE 4: while the appliance is making the coffee, delivery can be stopped at any time by pressing the ,  or  button as previously selected.

NOTE 5: as soon as delivery is complete, to increase the quantity of coffee, simply press and hold the ,  or  button as previously selected, until the desired quantity is reached (this operation must be performed within 3 seconds from when coffee delivery from the spouts ceases).

NOTE 6: *when the appliance displays:*

FILL TANK

the water tank must be refilled or the appliance will not make coffee.
(It is normal for there to be a little water left in the tank when the message is displayed).

NOTE 7: The appliance counts the number of coffees made. Every 14 single coffees (or 7 doubles) the appliance displays:

EMPTY GROUNDS CONTAINER

indicating that the grounds container is full and must be emptied and cleaned.
Until the grounds container has been cleaned, the appliance continues to display the message and cannot make coffee.

To clean, open the service door at the front by pulling the handle (fig. 14), remove the drip tray (fig. 15), empty and clean.

Empty the grounds container and clean thoroughly, making sure all residue deposited on the bottom are removed.

IMPORTANT: *when removing the drip tray, the grounds container MUST be emptied, even if it is not completely full. If this is not done, when making your next coffee the grounds in the container may exceed the maximum level and block the appliance.*

NOTE 8: while the appliance is delivering coffee, never remove the water tank. If it is removed, it will not be possible to make the coffee and the appliance will display:

GROUND TOO FINE ADJUST MILL AND

INSERT WATER SPOUT AND PRESS OK

To turn the appliance on again, you must insert the water spout (fig. 4), press the **OK** button and run off water from the spout for a few seconds.

When using the appliance for the first time, 4-5 cups of coffee need to be made before the appliance starts to give satisfying results.

If the appliance malfunctions, do not contact the service center right away.

The problem can almost always be resolved by following the instructions indicated in sections 18 and 19.

If this is not the case, or for further explanations, contact customer service by calling the number listed in the warranty or visit www.delonghi.com for a list of service centers near you. (U.S. and Canada)

7 CHANGING THE QUANTITY OF COFFEE IN THE CUP

The appliance is factory preset to automatically deliver the following quantities of coffee:

- short coffee (1.35 oz) (when the ☕ button is pressed);
- normal coffee (2.7 oz) (when the ☕ button is pressed);
- long coffee (4 oz) (when the ☕ button is pressed);

To change these quantities, proceed as follows:

- press the button corresponding to the quantity you want to change (☕, ☕ or ☕) for at least 8 seconds then release until the message "PROGRAM QUANTITY" is displayed and coffee is delivered;
- when the coffee in the cup reaches the required level, press the same button again to memorize the new amount.

The appliance is now re-programmed with the new settings and displays: READY.

8 REGULATING THE COFFEE MILL

The coffee grinder is preset in the factory to prepare coffee correctly and should not require regulating initially.

However, after making the first coffees, if you find that coffee delivery is either too fast or too slow (in drips), the grinding coarseness regulator can be adjusted (fig. 12).

Turning it 1 click (1 number) clockwise speeds up coffee delivery (without drips).

Turning 1 click counterclockwise slows down delivery giving a creamier appearance to the coffee.

These adjustments will only be evident after at least 2 cups of coffee have been delivered.

The grinding coarseness regulator must only be turned when the coffee mill is running.

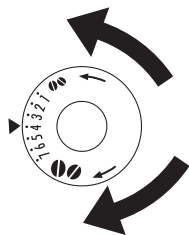

Turn one click counterclockwise to obtain slower delivery and a creamier appearance (finer ground coffee).

Turn one click clockwise for faster delivery (not a drop at a time) (coarser ground coffee).



Coffee has been used to factory test the appliance and it is, therefore, completely normal for there to be traces of coffee in the mill. This appliance is, however, guaranteed to be new.

9 PREPARING ESPRESSO/COFFEE WITH PRE-GROUND COFFEE (INSTEAD OF BEANS)

- Press the  button (fig. 16) to select the ground coffee function. This disables the coffee mill function. The appliance displays:

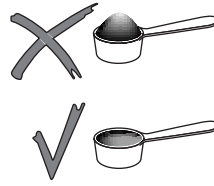
READY PRE-GROUND



- Lift the lid in the center, place one measuring scoop of ground coffee in the funnel (see fig. 17) and proceed as described in section 6.
Note: you can make just one coffee at a time by pressing the  
or  button once only.

- After using the appliance with pre-ground coffee, to go back to making coffee using beans, deactivate the ground coffee function by repressing the  button to prepare the grinder for operation again.

NOTE 1: Never add the ground coffee when the appliance is off to avoid it from being dispersed inside the appliance.

NOTE 2: Never add more than one level measuring scoop, otherwise either the appliance will not make the coffee, the ground coffee will be lost inside the appliance, dirtying it, or the coffee will run off in drips and the message "GROUND TOO FINE ADJUST MILL AND INSERT WATER SPOUT AND PRESS OK" will be displayed.

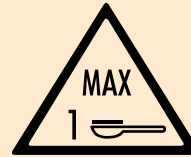

NOTE 3: When measuring the quantity of coffee to be added, use the measuring scoop supplied only.

NOTE 4: Do not use freeze-dried coffee or other materials that could damage the appliance.

NOTE 5: If the funnel blocks due to moisture inside the appliance or if more than one measuring scoop of pre-ground coffee has been used, use a plastic knife to push the coffee down (fig. 18), then remove and clean the infuser and appliance as described in paragraph 15.2 "Cleaning the infuser".

10 PRODUCING HOT WATER

- Always make sure the appliance is ready.
- Make sure the water spout is attached to the nozzle (fig. 4);
- Position a container under the spout (fig. 3).
- Press the  button (fig. 1).

The appliance displays:

HOT WATER

and hot water is delivered from the water spout into the container below (you should not run off hot water for more than two minutes at a time). To stop the flow, press the  button. Once the set quantity of hot water has been reached, delivery stops automatically.

11 CHANGING THE QUANTITY OF HOT WATER

The appliance is factory preset to automatically deliver 8.5 oz of hot water.

To change these quantities, proceed as follows:



- Attach the water spout (fig. 4).
- Position a container under the spout (fig. 3).
- Press the  button for at least 8 seconds then release. The appliance displays:

HOT WATER PROGRAM QUANTITY

and hot water is delivered from the water spout.

- When the hot water in the cup reaches the required level, press the  button to memorize the new amount. (You should not run off hot water for more than two minutes at a time).

12 PREPARING CAPPUCCINOS OR LATTE (MILK WITH COFFEE)

- Select the taste of the coffee you want to use to make the cappuccino by pressing the  button.
- Remove the frothed milk lid from the milk container.
- Fill the container with about 3.5 ounces of milk for each cappuccino to be prepared (fig. 19). **Never exceed the MAX level (corresponding to about 25 oz) marked on the container.** You are recommended to use skim or 2% milk at refrigerator temperature (about 41°F/5° C).
- If you want to make cappuccino (frothed milk + coffee), put the lid with the wording "FROTHED MILK - CAPPUCCINO" on the milk container. If, on the other hand, you want to prepare hot milk with coffee, put the lid with the wording "STEAMED MILK – LATTE" on the milk container.
- Make sure the milk intake tube is correctly inserted in the rubber washer (fig. 20) and that the frothed milk spout is moved outwards as shown in fig. 23.
- Remove the hot water spout (fig. 21) and attach the milk container to the nozzle, making sure the arrow on the container lid is lined up with the arrow on the control panel of the appliance (fig. 22).
- Position the milk tube as shown in fig. 23 and then place a sufficiently large cup under the coffee and milk spouts (fig. 23).
- Press the  button (fig. 24). The appliance displays:

CAPPUCCINO OR LATTE

and after a few seconds, the frothed milk is delivered from the milk spout into the cup below. (Delivery stops automatically).

- The appliance then grinds the beans, delivers the coffee and displays the "ready" message again.
- The cappuccino is ready. Sweeten to taste and, if desired, sprinkle the froth with a little cocoa powder.

NOTE 1: While preparing the cappuccino, milk or coffee delivery can be interrupted by pressing button .

NOTE 2: If you run out of milk while delivering the milk, remove the container and refill it. Then put it back in place and press the  button to request a cappuccino again.

NOTE 3: To ensure the milk frother is absolutely clean and hygienic, after making cappuccinos, clean the channels inside the milk container lid:

- Place a cup under the milk spout;
- Press the **CLEAN** button on the frothed milk container lid and hold down for at least 8 seconds (fig. 25). The appliance displays:

CLEANING

After cleaning is complete, remove the milk container and place in the refrigerator. You should not leave the milk outside the refrigerator for more than 15 minutes.

NOTE 4: To change the quantity of coffee or milk delivered automatically into the cup, follow the instructions in section 14.

13 PREPARING FROTHED MILK (WITHOUT COFFEE)

- Remove the lid of the milk container.
- Fill the container with the quantity of milk you want to prepare (fig. 19).
- If you want to prepare hot frothed milk, put the lid with the wording "FROTHED MILK – CAPPUCCINO" on the milk container. If, on the other hand, you want to prepare hot milk (without froth), put the lid with the wording "STEAMED MILK – LATTE" on the milk container.
- Attach the milk container to the appliance (fig. 22).
- Place a sufficiently large cup under the milk spout (fig. 23).
- Press the  button twice (within 2 seconds). The appliance displays:

MILK FROTHING

and after a few seconds, the frothed milk is delivered from the milk spout into the cup below.

- After delivery, clean the channels inside the milk container by pressing the **CLEAN** button as described in the previous section (note 3).

14 CHANGING THE QUANTITY OF COFFEE AND MILK FOR CAPPUCCINOS

The appliance is factory preset to automatically deliver a standard cappuccino. To change these quantities, proceed as follows:

- Fill the container with milk up to the maximum level indicated on the container.
- Press the  button for at least 8 seconds until the appliance displays:

MILK FOR CAPPUCCINO PROGRAM QUANTITY

Now release the button. The appliance starts to deliver milk.

- Once the required quantity of milk has been delivered, press the  button again. Milk delivery stops and the quantity is memorized. You should not run frothed milk for more than 3 minutes at a time.
- After a few seconds, the appliance delivers coffee into the cup and displays:

COFFEE FOR CAPPUCCINO PROGRAM QUANTITY

- Once the required quantity of coffee has been delivered, press the  button again. Coffee delivery stops and the quantity is memorized.

The appliance is now re-programmed with the new settings and displays: *READY*.

15 CLEANING AND MAINTENANCE

Before performing any cleaning operations, the appliance must have cooled down and must be disconnected from the outlet power supply.

Never immerse the appliance in the water: it is an electrical appliance.

Do not use solvents or abrasive cleaning products to clean the appliance. A soft damp cloth will suffice.

The infuser, grounds container, water tank and drip tray must NEVER be washed in the dishwasher.

15.1 Cleaning the coffee maker

Clean the grounds container (as described in section 6, note 7) whenever it requires emptying.

The water tank should also be cleaned regularly.

The drip tray is fitted with a level indicator (red) showing the level of water it contains.

When the indicator starts to become visible (a few millimeters under the drip tray), the drip tray must be emptied and cleaned.

Check that the holes in the coffee spout are not blocked.

To unblock them, scrape the dry coffee residues away with a needle (fig. 27).

Clean the nozzle regularly with a sponge as shown in fig. 26.

15.2 Cleaning the infuser

The infuser must be cleaned regularly to avoid the build-up of coffee encrustations which could cause mal-function. Proceed as follows:

- turn the appliance off by pressing the ① button (fig. 6) (do not unplug) and wait for the display to go off;
- open the service door (Fig. 14);
- remove the drip tray and the grounds container (Fig. 15) and clean them;
- press the two red release buttons on the infuser sideways and towards the center (Fig. 28) and pull it out;
- **IMPORTANT: THE INFUSER CAN ONLY BE REMOVED IF THE APPLIANCE IS OFF. ATTEMPTING TO REMOVE THE INFUSER WITH THE APPLIANCE ON MAY CAUSE SERIOUS DAMAGE.**
- wash the infuser under running water, without using detergents. Never wash the infuser in the dishwasher;
- carefully clean the inside of the appliance. To remove the coffee stuck to the parts inside the appliance, scrape it with a plastic or wooden fork (Fig. 29) and then pick up all the residues using a vacuum cleaner (Fig. 30);
- replace the infuser by sliding it onto the supports and pin at the bottom, then push the PUSH symbol fully in until it clicks into place.

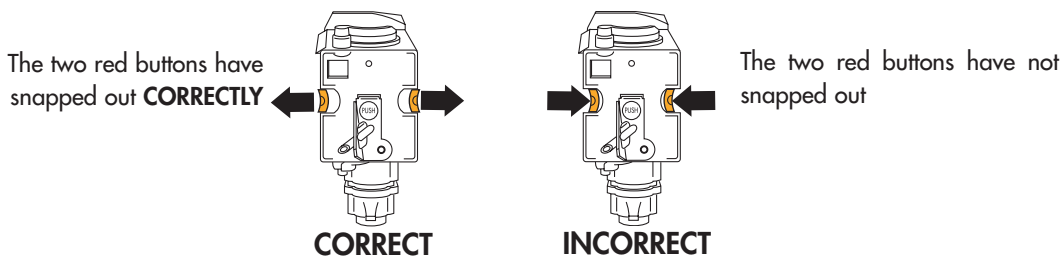
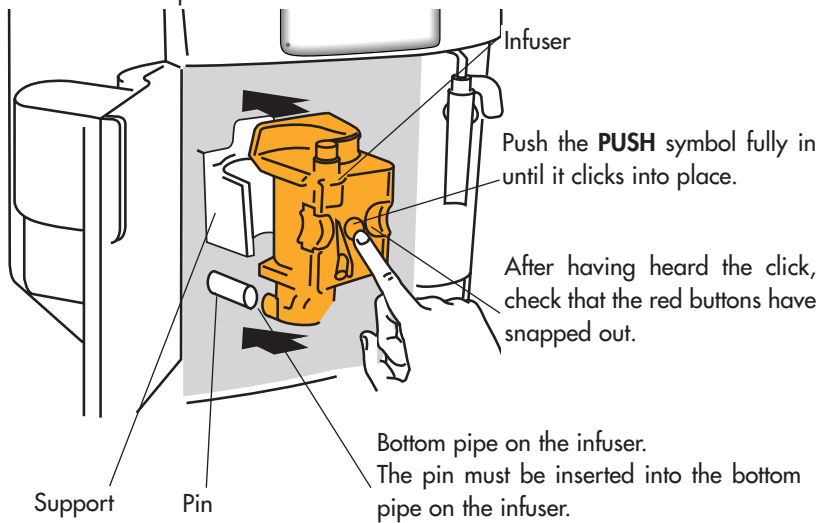

Check that the two red buttons have snapped out, otherwise the door cannot be closed.

- replace the drip tray, complete with the grounds container;
- close the service door.

NOTE 1: If the infuser is not inserted correctly, until it clicks into place, and the two red buttons have not snapped out, the service door cannot be closed.

NOTE 2: If it is hard to insert the infuser, before inserting it, squeeze to size by pressing it vigorously from above and below at the same time, as shown in Figure 31.

NOTE 3: If it is still hard to insert the infuser, leave it out of the appliance, close the service door, unplug from the outlet, then plug in again. Wait for all the lights to go off after the self-diagnosis, then open the door and replace the infuser.

15.3 Cleaning the milk container

Proceed as follows:

- Remove the milk spouts (fig. 32) and the milk intake tubes.

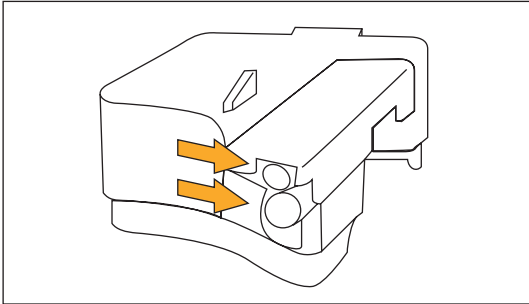

- Wash the container and lids in a dishwasher or in hot soapy water.
- Make sure there are no milk residues inside the two holes in the lids of the milk container indicated by the arrows in the figure or the milk intake tubes.
- To replace the components of the lid with the wording "STEAMED MILK - LATTE", insert the milk spout and milk intake tube (the softer one) in the hole in the lid as shown in fig. 20.
- To replace the components of the lid with the wording "FROTHED MILK - CAPPUCCINO", insert the milk spout and milk intake tube (the harder one) in the hole in the lid as shown in fig. 20.

Note: To avoid using the wrong intake tube, the "STEAMED MILK -LATTE" tube cannot be inserted in the "FROTHED MILK - CAPPUCCINO" lid and the "FROTHED MILK - CAPPUCCINO" tube cannot be inserted in the "STEAMED MILK - LATTE" lid.

16 CHANGING AND SETTING THE MENU PARAMETERS

After pressing the **ⓘ** button, when the appliance is ready, you can use the internal menu to modify the following parameters and functions:

- Clock
- Auto-start time
- Descaling process
- Coffee temperature
- Length of time the appliance remains on
- Water hardness
- Factory default values

16.1 Setting the clock

To set the clock, proceed as follows:

- Press the **MENU** button (the light over the button comes on) then press the **NEXT** button repeatedly until the appliance displays:

CLOCK 00:00

- Press the **CHANGE** button to set the clock. (If you hold the **CHANGE** button down, the time is changed rapidly).
- Press the **OK** button to confirm the value;
- Press the **MENU** button to exit programming mode or **NEXT** to change other parameters.

16.2 Setting auto-start time

This programs the time the appliance will come on automatically and be ready for use.

- Make sure the clock on the appliance is set as described above.
- Press the **MENU** button (the light over the button comes on) then press the **NEXT** button repeatedly until the appliance displays:

START TIME 00:00

- Press the **CHANGE** button to set the auto-start time. (If you hold the **CHANGE** button down, the time is changed rapidly).
- Press the **OK** button to confirm the value;
- Press **NEXT** once and the appliance displays the message:

AUTO-START NO

Press the **CHANGE** button to modify the function (the appliance displays: *AUTO-START YES*)

- Press the **OK** button to activate auto-start;

NOTE: when the appliance is turned off and auto-start time is set, the symbol  appears alongside the time on the unlit display.

- Press the **MENU** button to exit programming mode or **NEXT** to change other parameters.

16.3 Descaling

Over time, the continuous heating up of the water used to make the coffee leads to lime scale building up in the inner circuits of the appliance.

When the appliance displays the message:

DESCALE

you should perform the descale cycle.

Proceed as follows:

- make sure the appliance is ready.
- press the **MENU** button (the light over the button comes on) then press the **NEXT** button repeatedly until the appliance displays:

DESCALE NO

- Press **CHANGE** and the appliance displays the message:

DESCALE YES

- Press the **OK** button to start the descale program.
- Empty the water tank and pour in the contents of one bottle (125 ml) of DURGOL descaler plus 34 oz. of water. For subsequent descaling operations, descaling solution can be purchased from authorized technical service centers.

Note: Make sure splashes of descaler do not fall onto surfaces sensitive to acid such as marble, limestone and granite.

- Place a plastic or glass container with a minimum capacity of 34 ounces under the hot water spout (Fig. 3);
- press the **OK** button. Descaler runs off from the hot water spout into the container below. The appliance displays:

APPLIANCE IN DESCALING

- the descale program automatically performs a series of run offs and pauses to remove lime scale deposits from inside the coffee maker.
- After about 30 minutes, the appliance displays:

RINSING FILL TANK

The appliance must now be rinsed thoroughly to eliminate residues of descaling solution from inside the appliance. Proceed as follows:

- empty the water tank, rinse and fill with clean water.
- Reposition the tank.

- Empty the collection container and put it back under the hot water spout.
- Press the **OK** button. Hot water is delivered from the spout into the container below and the appliance displays:

RINSING

- When the water tank is empty, the appliance displays the message:

RINSING COMPLETE PRESS OK

- Press the **OK** button and refill the water tank with clean water.
- The descale program is now terminated and the appliance is ready to make coffee again.

NOTE: If the descaling cycle is interrupted before completion, the appliance continues to display the descale message and the program must be started again from the beginning.

IMPORTANT: FAILURE TO DESCALE THE APPLIANCE REGULARLY INVALIDATES THE WARRANTY.

16.4 Changing coffee temperature

To change the temperature of the coffee, proceed as follows:

- Press the **MENU** button (the light over the button comes on) then press the **NEXT** button repeatedly until the appliance displays:

TEMP. EXTRA HOT

- Press the **CHANGE** button until the appliance displays the required coffee temperature.
- Press the **OK** button to confirm the temperature selected;
- Press the **MENU** button to exit programming mode or **NEXT** to change other parameters.

16.5 Changing the length of time the appliance remains on

The appliance is factory preset to go off automatically one hour after the last coffee has been made.

The number of hours the appliance remains on (max. 3) can be increased as follows:

- Press the **MENU** button (the light over the button comes on) then press the **NEXT** button repeatedly until the appliance displays: OFF AFTER 1 HOUR.
- Press the **CHANGE** button to change the number of hours the appliance remains on.
- Press the **OK** button to confirm the value;
- Press the **MENU** button to exit programming mode or **NEXT** to change other parameters.

16.6 Setting water hardness

The descale message is displayed after the appliance has been operated for a factory set period of time calculated on the basis of the maximum quantity of lime scale which may be contained in the water used.

If necessary, this period of operation can be extended, making descaling less frequent, by programming the appliance based on the actual lime content in the water used.

Proceed as follows:

- remove the "Total Hardness Test" strip (enclosed on page 2) from its packaging then dip it fully in the water for a few seconds. Remove it and wait around 30 seconds (until it changes color and a number of squares are formed);
- Turn the appliance on by pressing the **ⓘ** button (fig. 6).
- Press the **MENU** button (the light over the button comes on) then press the **NEXT** button repeatedly until the appliance displays:

WATER HARDNESS 4

- Press the **CHANGE** button repeatedly until the number coincides with the number of squares on the test strip (for example, if there are 3 squares on the test strip, press the button until WATER HARDNESS 3 is displayed).
- Press the **OK** button to confirm the value. The coffee maker is now programmed to provide the descaling warning when necessary, based on the actual hardness of the water.

16.7 Resetting factory default settings (reset)

If you change the original values, the factory default values can be reset as follows:

- Press the **MENU** button (the light over the button comes on) then press **NEXT** repeatedly until the appliance displays:

RESET TO DEFAULT NO

- Press the **CHANGE** button and the appliance displays "RESET TO DEFAULT YES"
- Press the **OK** button to reset the factory default values;
- The appliance is now reset to the factory default settings and the **READY** message is displayed.

17 CHANGING THE LANGUAGE

To change the language, press the **CHANGE** button for at least 5 seconds until the appliance displays the installation message in various languages. To select the required language, follow the instructions in section 4.1.

18 TROUBLESHOOTING

MESSAGE	MEANING	WHAT TO DO
<i>FILL TANK</i>	<ul style="list-style-type: none"> • The water tank is empty or is positioned incorrectly. • The tank is dirty or encrusted with lime scale. 	<ul style="list-style-type: none"> • Fill the water tank as described in section 6, note 6 and insert it fully. • Rinse or descale the tank.
<i>GROUND TOO FINE ADJUST MILL AND INSERT WATER SPOUT AND PRESS OK</i>	<ul style="list-style-type: none"> • The appliance cannot make coffee. • The coffee runs off too slowly. 	<ul style="list-style-type: none"> • Insert the hot water spout, press the  button and deliver water from the spout for a few seconds. • Turn the grinding regulator (fig. 12) one click clockwise (see section 8).
<i>EMPTY GROUNDS CONTAINER</i>	<ul style="list-style-type: none"> • The grounds container is full or missing. 	<ul style="list-style-type: none"> • Empty the grounds container and clean as described in section 6, note 7, then replace.
<i>INSERT GROUNDS CONTAINER</i>	<ul style="list-style-type: none"> • After cleaning, the grounds container has not been replaced. 	<ul style="list-style-type: none"> • Open the service door and insert the grounds container.
<i>ADD PRE-GROUND COFFEE</i>	<ul style="list-style-type: none"> • With the function selected, the pre-ground coffee has not been poured into the funnel. 	<ul style="list-style-type: none"> • Add the ground coffee as described in section 9.
<i>FILL BEANS CONTAINER</i>	<ul style="list-style-type: none"> • The coffee beans have run out. • If the coffee grinder is very noisy, this means a small stone in the coffee beans has blocked the mill. 	<ul style="list-style-type: none"> • Fill bean container. • Contact an authorized De' Longhi service center.
<i>DESCALE</i>	<ul style="list-style-type: none"> • This indicates the presence of lime scale in the appliance. 	<ul style="list-style-type: none"> • The descaling procedure, described in section 16.3, needs to be performed as soon as possible.

MESSAGE	MEANING	WHAT TO DO
<i>PRESSNEXT CHANGE</i>	<ul style="list-style-type: none"> After cleaning, the infuser has probably been left out of the coffee maker. 	<ul style="list-style-type: none"> Leave the service door closed and the infuser out of the appliance, then follow the instructions displayed.
<i>CLOSE DOOR</i>	<ul style="list-style-type: none"> The service door is open. 	<ul style="list-style-type: none"> If the service door cannot be closed, check that the infuser is inserted correctly (section 15.2 - note 1).
<i>INSERT INFUSER ASSEMBLY</i>	<ul style="list-style-type: none"> After cleaning, the infuser has probably been left out of the coffee maker. 	<ul style="list-style-type: none"> Insert the infuser, see section 15.2.
<i>LESS COFFEE</i>	<ul style="list-style-type: none"> The ground coffee funnel is clogged. Too many coffee beans or too much ground coffee has been added. 	<ul style="list-style-type: none"> Empty the funnel with the help of a plastic knife, as described in section 9 note 5 (Fig.18). Select a milder taste or reduce the quantity of ground coffee, then deliver the coffee again.
<i>GENERIC ALARM</i>	<ul style="list-style-type: none"> The inside of the appliance is very dirty. 	<ul style="list-style-type: none"> Clean the inside of the appliance thoroughly, as described in section 15. If the message is still displayed after cleaning, contact a service center.

19 PROBLEMS THAT CAN BE RESOLVED BEFORE CALLING THE SERVICE CENTER

If the appliance is not working, the causes of the malfunction can be identified and resolved by referring to section 18.

If the malfunction still remain, run the following checks before calling the service center.

PROBLEM	CAUSE	SOLUTION
The coffee is not hot.	<ul style="list-style-type: none"> The cups have not been preheated. The infuser is too cold. 	<ul style="list-style-type: none"> Heat the cups by rinsing them in hot water or leaving them to rest for at least 20 minutes on the cup warmer tray on the cup warmer tray on the top of the appliance with the appliance on (see section 6, note 3). Heat the infuser by pressing the  button (fig. 13) before making the coffee (see section 6, note 3).
The coffee is not creamy enough.	<ul style="list-style-type: none"> The coffee is ground too coarsely. Wrong type of coffee. 	<ul style="list-style-type: none"> Turn the grinding adjustment knob one click counterclockwise (see section 8). Use a type of coffee for espresso coffee makers.
The coffee runs out too slowly.	<ul style="list-style-type: none"> The coffee is ground too finely. 	<ul style="list-style-type: none"> Turn the grinding adjustment knob one click clockwise (see section 8).
The coffee runs out too quickly.	<ul style="list-style-type: none"> The coffee is ground too coarsely. 	<ul style="list-style-type: none"> Turn the grinding adjustment knob one click counterclockwise (see section 8).
The coffee does not come out of one of the spouts.	<ul style="list-style-type: none"> The spout holes are blocked. 	<ul style="list-style-type: none"> Scrape the remains of dry coffee accumulated with a needle (Fig. 27).

PROBLEM	CAUSE	SOLUTION
When the ☞, ☞ and ☞ buttons are pressed, the appliance does not deliver coffee, but only water.	<ul style="list-style-type: none"> The ground coffee may be blocked in the funnel. 	<ul style="list-style-type: none"> Remove the ground coffee inside the funnel using a plastic knife (see note 5, section 9). Then clean the infuser and the inside of the appliance (see section 15).
When the ① button is pressed, the appliance does not come on.	<ul style="list-style-type: none"> The appliance is not plugged in. 	<ul style="list-style-type: none"> Check that the power cable is plugged into the outlet.
The infuser cannot be removed for cleaning.	<ul style="list-style-type: none"> The appliance is on. The infuser can only be removed if the appliance is off. 	<ul style="list-style-type: none"> Turn the appliance off and remove the infuser (see section 15.2). IMPORTANT: the infuser can only be removed if the appliance is off. Attempting to remove the infuser with the appliance on will risk causing damage.
Pre-ground coffee is being used (not beans) and the appliance does not deliver coffee.	<ul style="list-style-type: none"> Too much ground coffee has been added. The ☞ button has not been pressed and the appliance has used both the ground coffee added and the coffee ground by the grinder. Ground coffee has been added when the appliance is off. 	<ul style="list-style-type: none"> Remove the infuser and thoroughly clean the inside of the appliance, as described in section 15. Repeat the operation using a maximum of 1 measuring scoop of ground coffee. Thoroughly clean the inside of the appliance, as described in section 15. Repeat the operation, first pressing the ☞ button as described in section 9. Remove the infuser and thoroughly clean the inside of the appliance, as described in section 15. Repeat the operation, but switch the appliance on first.
The coffee does not come out of the spouts, but rather around the service door.	<ul style="list-style-type: none"> The holes in the spouts are clogged with dry coffee. The mobile drawer inside the service door is blocked and cannot swing. 	<ul style="list-style-type: none"> Scrape the holes with a needle (see section 15.1, Fig. 27). Thoroughly clean the mobile drawer, particularly near the hinges to ensure they are free to swing smoothly.
The milk does not run out of the milk spout.	<ul style="list-style-type: none"> The intake tube is not inserted or is inserted incorrectly. 	<ul style="list-style-type: none"> Insert the intake tube in the rubber washer in the milk container lid (fig. 20).
The milk is not well frothed.	<ul style="list-style-type: none"> The milk container lid is dirty. 	<ul style="list-style-type: none"> Clean the milk lid as described in section 15.3.
The milk contains bubbles or squirts out of the milk spout.	<ul style="list-style-type: none"> The milk is not cold enough or is not skim or 2% milk. 	<ul style="list-style-type: none"> Use skim or 2% milk at refrigerator temperature. If you are still not getting the required results, try changing the brand of milk.



This warranty applies to Super Automatic Espresso Machines with the De'Longhi brand name.

LIMITED WARRANTY

What does the warranty cover?

We warrant each appliance to be free from defects in material and workmanship. Our obligation under this warranty is limited to repair at our factory or authorized service center of any defective parts or part thereof, other than parts damaged in transit. The repaired or new model will be returned at the company expense.

This warranty shall apply only if the appliance is used in accordance with the factory directions, which accompany it, and on an alternating current (AC) circuit.

How long does the coverage last?

This warranty runs for two years (2) from the purchase date found on your receipt and applies only to the original purchaser for use.

What is not covered by the warranty?

The warranty does not cover defects or damage of the appliance, which result from repairs or alterations to the appliance outside our factory or authorized service centers, nor shall it apply to any appliance, which has been subject to abuse, misuse, negligence or accidents. Also, consequential and incidental damage resulting from the use of this product or arising out of any breach of contract or breach of this warranty are not recoverable under this warranty. Some states do not allow the exclusion or limitation of incidental or consequential damage, so the above limitation may not apply to you.

How do you get service?

If repairs become necessary, see contact information below:

U.S. Residents:

Please contact our toll free hotline at #1-866-Latte-Best or log onto our website at www.delonghi.com.
For all accessories, spare parts or replacement parts, please contact our parts division at 1-866-528-8323.

Residents of Canada:

Please contact our toll free hotline at #1-866-Latte-Best or 1-866-528-8323 (Hours of Operation: Monday - Friday 8:30am - 8pm, Saturday & Sunday 9:00am - 5:30pm) or log onto our website at www.delonghi.com.

Residents of Mexico:

Please refer to the Limited Warranty statement for Mexico (page 62).

Please refer to the back page of the manual for De'Longhi addresses.

The above warranty is in lieu of all other express warranties and representations. All implied warranties are limited to the applicable warranty period set forth above. This limitation does not apply if you enter into an extended warranty with De'Longhi. Some states do not allow limitations on how long an implied warranty lasts, so the above exclusions may not apply to you. De'Longhi does not authorize any other person or company to assume for it any liability in connection with the sale or use of its appliance.

How does state law apply?

This warranty gives you specific legal rights, and you may also have other rights, which vary from state to state.