

This Owner's Manual is provided and hosted by [Appliance Factory Parts](#).



LENNOX CBH19-31 Owner's Manual

[Shop genuine replacement parts for LENNOX
CBH19-31](#)



[Find Your LENNOX Air Cleaner Parts - Select From 418 Models](#)

----- Manual continues below -----

**CB19 AND CBH19 SERIES
UP-FLOW, DOWN-FLOW AND HORIZONTAL
BLOWER COIL UNITS**

**CB19/
CBH19**

***12,600 to 65,500 Btuh (3.7 to 19.2 kW) Cooling Capacity**
11,500 to 60,000 Btuh (3.4 to 17.6 kW) Heat Pump Heating Capacity
6,400 to 102,400 Btuh (1.9 to 30.0 kW) Optional Electric Heat

Bulletin #210056
January 1995
Supersedes
April 1994

*ARI Standard 210/240 Ratings With Matching Outdoor Unit

Applications — The CB19 and CBH19 blower coil units are designed for multi-position installation in a basement, utility room, alcove, closet, crawlspace or attic. Units are applicable to expansion valve systems in cooling applications and check and expansion valve systems in heat pump applications. Units have factory installed check and expansion valve. Several models are available in varying sizes with a wide range of cooling and heating capacities. See Condensing Unit bulletins in section Cooling Units — Condensing Units for cooling capacities. See Heat Pump Outdoor Unit Bulletins in section Heat Pumps — Matched Remote Systems for cooling and heating capacities. Optional field installed electric heaters are available in several sizes for additive heating capacity.

CB19 models are applicable to up-flow or down-flow discharge air applications. Units are shipped for up-flow applications and may easily be field converted to the down-flow position by turning the unit upside down and repositioning the coil, drip shields and cabinet access panel. Filters are not furnished and must be provided by the installer. An optional side return air adapter with filter(s) is available for up-flow applications only. An optional additive base is available for models with electric heat installed in the down-flow position on combustible floors.

CBH19 models are designed for horizontal discharge air applications. Units are furnished with left hand air discharge as standard and may be field changed to right hand discharge by turning the unit over (end for end) and repositioning the coil. CBH19-51 and CBH19-65 models are furnished in a two piece cabinet with blower and optional electric heaters in one section and the indoor coil in the other. Hardware is furnished for field connection of cabinets. Filters are not furnished and must be provided by the installer.

CB19 MODEL — UP-FLO

CB19 MODEL — DOWN-FLO

CBH19 MODEL — HORIZONTAL

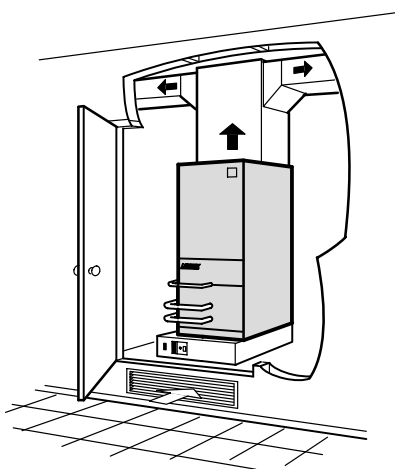

Up-Flow Installation
with optional electronic air cleaner

Typical Applications

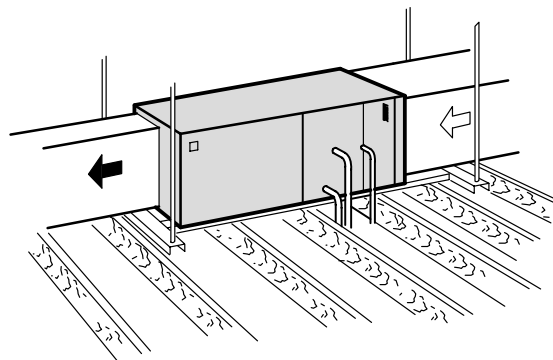

Horizontal Installation

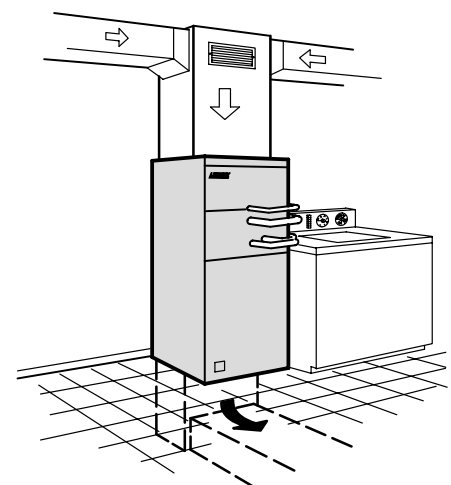

Down-Flow Installation

☼ The maple leaf symbol in this bulletin denotes Canadian only usage where applicable

NOTE — Due to Lennox' ongoing commitment to quality, Specifications, Ratings and Dimensions subject to change without notice and without incurring liability.

FEATURES

Completely Tested — Blower coil units are tested with matching condensing units in the Lennox Research Laboratory environmental test room in accordance with ARI Standard 210/240-89. Optional electric heaters are rated in accordance with U.S. Department of Energy (DOE) test procedures and Federal Trade Commission (FTC) labeling regulations. Blower performance data is according to actual unit tests conducted in Lennox air test chamber. Blower-coil units and components within are bonded for grounding to meet safety standards for servicing required by U.L., C.S.A., CEC and NEC.

Cabinet — Constructed of heavy gauge galvanized steel and completely insulated with thick fiberglass insulation. The pre-painted steel cabinets have a finish of mildly textured enamel with a primer coat on the unpainted side of all panels. Removable panels provide complete service access. Electrical inlets are provided in both sides of cabinet. Return air entry is possible in either side or bottom of cabinet on up-flow units.

Drain Pan — Deep, corrosion resistant drain pan has dual pipe drains extended outside of cabinet for ease of connection. See dimension drawings.

Direct Drive Blower — Equipped with a Lennox designed and built direct drive blower. Each blower is statically and dynamically balanced as an assembly before it is installed in the unit. Multi-speed motor is resiliently mounted. A choice of blower speeds is available. See blower performance tables. Change of blower speeds is easily accomplished by a simple change in wiring.

Refrigerant Line Connections — Suction (vapor) and liquid lines have sweat connections and extend outside of the cabinet for ease of connection. See dimension drawings for locations.

Check and Expansion Valve Furnished — Check and expansion valve furnished and factory installed on all models.

Copper Tube/Enhanced Fin Evaporator Coil — Lennox designed twin coils, assembled in a 'V' configuration, provides extra large surface and contact area, excellent heat transfer and low air resistance for maximum efficiency. Precise circuiting gives uniform refrigerant distribution. Lennox fabricated coil is constructed of precisely spaced ripple-edged aluminum fins fitted to durable seamless copper tubes. Fins are strengthened to resist bending and are equipped with collars that grip tubing for maximum contact area. Lanced fins provide maximum exposure of fin surface to air stream. Flared shoulder tubing joints and silver soldering provide tight, leak-proof joints. Long life copper tubing is easy to field service. Coil is thoroughly factory tested under high pressure to insure leakproof construction.

Transformer and Blower Cooling Relay — A 24 volt transformer and blower cooling relay are furnished as standard equipment and are factory installed in the unit control box. A terminal strip is also furnished as standard.

OPTIONAL ACCESSORIES (Must Be Ordered Extra)

Electric Heat (Optional) — Additive electric heaters field install internal to the unit cabinet and are available in several kw sizes, see Electric Heat table. The helix wound nichrome bare heating elements are exposed directly in the air stream resulting in instant heat transfer, low element temperatures and long service life. Each heating element is equipped with accurately located limit control with fixed temperature off setting and automatic reset. In addition, elements have supplemental thermal cutoff safety fuses providing positive protection in case of excessive temperatures. Cutoff fuses are mounted external to the element face plate for quick and easy replacement. Thermal sequencer relay brings the heating elements on and off line, in sequence and equal increments, with a time delay between each element. Sequencer also initiates and terminates blower operation. Heating control relay(s), is furnished as standard. Control box and access cover are constructed of heavy gauge galvanized steel. Heaters are factory assembled with controls installed and wired and only require plug-in field connection.

Circuit Breakers — ECB19-12.5,-15,-20,-25 and -30 kw (208/240v-1ph) and ECB19-15,-20 and -25 kw (208/240v-3ph) electric heaters are equipped with circuit breakers to provide overload and short circuit protection. Breakers are factory wired and mounted on electric heat unit. Circuit breakers are current sensitive and temperature actuated to shut off heater if current draw is excessive. Must be reset manually. Circuit breakers qualify as the disconnect means at unit in many areas and eliminate the need for a field provided disconnect. Consult local electrical code in your area.

Single-Point Power Source Control Box (Optional) — Control Box (21H39) may be used with optional electric heat when two or three circuits (if required by code) are specified. Field installs external to the unit cabinet on either side or top. Provides single power service connection to the unit. Constructed of heavy gauge steel with baked enamel finish, prepunched mounting holes, electrical inlet knockouts, and terminal strip. Removeable cover provides easy access. Box is 7" x 7" x 4" deep (178mm x 178mm x 102mm), shipping weight is 5 lbs. (2 kg.)

CCB1 EfficiencyPlus™ Humidity Control (Optional) — The CCB1 Humidity Control (35H00) is an electronic control which installs next to the room thermostat and allows the selection of the desired indoor humidity level in the cooling mode. During the heating season the control is inoperable. The CCB1 controls the indoor humidity by altering the indoor blower speed and the compressor speed. Humidity level desired may be accomplished by adjusting a vertical slide to a set point on a scale of 40% thru 60% with 50% recommended as the initial set point. Five indicator lights (MIN — MAX) in a bar graph configuration indicate the difference in the actual relative humidity and the set point. This indicates the demand imposed on the system equipment, the more lights on, the longer the equipment will operate to obtain the desired humidity level. If no lights are on, the humidity is at or below the set point. Control is not furnished and must be ordered extra. Requires EBR1 Blower Relay Kit

EBR1 Blower Relay Kit (Optional) — EBR1 Blower Relay Kit (75H90) allows CCB1 to be used with CB19/CBH19 blower coil units.

Down-Flow Additive Base (Optional) — An optional additive base is required for models with electric heat installed in the down-flow position on combustible floors. Base is not furnished and must be ordered extra for field installation. See Specifications table and dimension drawing.

Air Filters (Not Furnished) — Filters must be ordered extra. See Specifications tables for sizes. Filter rails are provided in return air opening of unit. See dimension drawings.

CB19 Up-Flow Side Return Air Filter Adaptor (Optional) — Field installs on either side return air opening of up-flow cabinet. Constructed of heavy gauge galvanized steel with a baked-on paint finish. Equipped with flanges for ease of duct connection. Access panel allows easy removal and replacement of filter(s). One inch thick (25mm) frame type filter is furnished as standard. Media is washable or vacuum cleanable oil coated polyurethane. CB19-21 thru 41 adaptor requires one filter. CB19-51 and CB19-65 model has two. See Specification table for sizes. CB19-51 and CB19-65 fiberglass insulated adaptor is shipped knocked down and must be field assembled.

SPECIFICATIONS – CB19 UP-FLOW/DOWN-FLOW

Model Number		CB19-21	CB19-26	CB19-31	CB19-41	CB19-51	CB19-65	
Evaporator Coil	Net face area – ft. ² (m ²)	4.22 (0.39)	4.22 (0.39)	5.27 (0.49)	5.27 (0.49)	7.0 (0.65)	7.0 (0.65)	
	Tube outside diameter – in. (mm)	3/8 (9.5)	3/8 (9.5)	3/8 (9.5)	3/8 (9.5)	3/8 (9.5)	3/8 (9.5)	
	Number of rows	3	3	3	3	3	3	
	Fins per inch (fins per m)	12 (472)	12 (472)	13 (512)	13 (512)	14 (551)	14 (551)	
	Suct. (vapor) line conn. – in. (mm) sweat	5/8 (16)	5/8 (16)	3/4 (19)	3/4 (19)	7/8 (22.2)	1-1/8 (28)	
	Liquid line conn. – in. (mm) sweat	3/8 (9.5)	3/8 (9.5)	3/8 (9.5)	3/8 (9.5)	3/8 (9.5)	3/8 (9.5)	
Condensate drain connection (pvc) – in. (mm)		(2) 3/4 (19)	(2) 3/4 (19)	(2) 3/4 (19)	(2) 3/4 (19)	(2) 3/4 (19)	(2) 3/4 (19)	
Nominal cooling capacity – tons (kW)		1-1/2 (5.3)	2 (7.0)	2-1/2 (8.8)	3 (10.6)	4 (14.1)	5 (17.6)	
Refrigerant		HCFC-22						
Blower wheel nominal diameter x width – in. (mm)		9 x 7 (229 x 178)	9 x 8 (229 x 203)	10 x 7 (254 x 178)	10 x 9 (254 x 229)	11 x 8 (279 x 203)	12 x 9 (317 x 229)	
Blower motor output – hp (W)		1/10 (75)	1/5 (149)	1/3 (149)	1/3 (249)	1/3 (249)	1/2 (373)	
††Number and size of filters	in.	(1) 16 x 20 x 1		(1) 20 x 20 x 1		(1) 20 x 25 x 1		
	mm	(1) 406 x 508 x 25		(1) 508 x 508 x 25		(1) 508 x 635 x 25		
Electrical characteristics		208/230 volts – 60 hz – 1 ph				208/230/460 volt 60 hz – 1 ph		
Shipping weight – lbs. (kg) 1 package		143 (65)	146 (66)	167 (76)	167 (76)	209 (95)	213 (97)	
◆ Optional Accessories (Must Be Ordered Extra) ◆								
Side Return Air Filter Adaptor (Up-Flow Only)	Catalog number		95G73		95G74		95G75	
	Number and size of filters	in.	(1) 16 x 20 x 1		(1) 20 x 20 x 1		(2) 16 x 25 x 1	
		mm	(1) 406 x 508 x 25		(1) 508 x 508 x 25		(2) 406 x 635 x 25	
	Shipping weight – lbs. (kg)		4 (2)		5 (2)		24 (11)	
Down-Flow Combustible Base	Catalog number		85G52		85G53		85G54	
	Ship. wt. – lbs. (kg)		8 (4)		8 (4)		8 (4)	
Electric Heat Capacity	ECB19-2.5	*Output – Btuh (kW)	9,000 (2.6)	9,500 (2.8)	----	----	----	----
		†A.F.U.E.	100%	100%	----	----	----	----
	ECB19-5	*Output – Btuh (kW)	18,000 (5.3)	18,000 (5.3)	18,000 (5.3)	18,000 (5.3)	19,000 (5.6)	----
		†A.F.U.E.	100%	100%	100%	100%	100%	----
	ECB19-6	*Output – Btuh (kW)	21,000 (6.2)	22,000 (6.4)	22,000 (6.4)	22,000 (6.4)	23,000 (6.7)	----
		†A.F.U.E.	100%	100%	100%	100%	100%	----
	ECB19-7.5	*Output – Btuh (kW)	25,000 (7.3)	25,000 (7.3)	25,000 (7.3)	25,000 (7.3)	26,000 (7.6)	----
		†A.F.U.E.	100%	100%	100%	100%	100%	----
	ECB19-8	*Output – Btuh (kW)	28,000 (8.2)	28,000 (8.2)	29,000 (8.5)	29,000 (8.5)	29,000 (8.5)	30,000 (8.8)
		†A.F.U.E.	100%	100%	100%	100%	100%	100%
	ECB19-10	*Output – Btuh (kW)	35,000 (10.3)	35,000 (10.3)	35,000 (10.3)	35,000 (10.3)	36,000 (10.5)	37,000 (10.8)
		†A.F.U.E.	100%	100%	100%	100%	100%	100%
	ECB19-12.5	*Output – Btuh (kW)	----	44,000 (12.9)	44,000 (12.9)	44,000 (12.9)	45,000 (13.2)	46,000 (13.5)
		†A.F.U.E.	----	100%	100%	100%	100%	100%
	ECB19-15	*Output – Btuh (kW)	----	52,000 (15.2)	52,000 (15.2)	53,000 (15.5)	53,000 (15.5)	54,000 (15.8)
		†A.F.U.E.	----	100%	100%	100%	100%	100%
	ECB19-20	*Output – Btuh (kW)	----	----	----	70,000 (20.5)	70,000 (20.5)	71,000 (20.8)
		†A.F.U.E.	----	----	----	100%	100%	100%
	ECB19-25	*Output – Btuh (kW)	----	----	----	----	87,000 (25.5)	88,000 (25.8)
		†A.F.U.E.	----	----	----	----	100%	100%
ECB19-30	*Output – Btuh (kW)	----	----	----	----	----	105,000 (30.8)	
	†A.F.U.E.	----	----	----	----	----	100%	

†Annual Fuel Utilization Efficiency based on U.S. DOE test procedures and according to FTC labeling regulations

††Filters are not furnished and must be ordered extra.

*Includes additional blower motor heat capacity.

SPECIFICATIONS — CBH19 HORIZONTAL

Model Number		CBH19-21	CBH19-26	CBH19-31	CBH19-41	CBH19-51	CBH19-65	
Blower section		----	----	----	----	B19-51	B19-65	
Indoor coil section		----	----	----	----	CH19-51	CH19-65	
Evaporator Coil	Net face area — ft. ² (m ²)	4.22 (0.39)	4.22 (0.39)	5.27 (0.49)	5.27 (0.49)	7.22 (0.67)	7.22 (0.67)	
	Tube outside diameter — in. (mm)	3/8 (9.5)	3/8 (9.5)	3/8 (9.5)	3/8 (9.5)	3/8 (9.5)	3/8 (9.5)	
	Number of rows	3	3	3	3	3	3	
	Fins per inch (fins per m)	12 (472)	12 (472)	13 (512)	13 (512)	14 (551)	14 (551)	
	Suct. (vapor) line conn. — in. (mm) sweat	5/8 (16)	5/8 (16)	3/4 (19)	3/4 (19)	7/8 (22.2)	1-1/8 (28)	
Liquid line connection — in. (mm) flare	3/8 (9.5)	3/8 (9.5)	3/8 (9.5)	3/8 (9.5)	3/8 (9.5)	3/8 (9.5)		
Condensate drain connection (mpt) — in. (mm)		(2) 3/4 (19)	(2) 3/4 (19)	(2) 3/4 (19)	(2) 3/4 (19)	(2) 3/4 (19)	(2) 3/4 (19)	
Nominal cooling capacity — tons (kW)		1-1/2 (5.3)	2 (7.0)	2-1/2 (8.8)	3 (10.6)	4 (14.1)	5 (17.6)	
Refrigerant		HCFC-22						
Blower wheel nominal diameter x width — in. (mm)		9 x 7 (229 x 178)	9 x 8 (229 x 203)	10 x 7 (254 x 178)	10 x 9 (254 x 229)	11 x 8 (279 x 203)	12 x 9 (317 x 229)	
Blower motor output — hp (W)		1/10 (75)	1/5 (149)	1/3 (149)	1/3 (249)	1/3 (249)	1/2 (373)	
††Number and size of filters	in.	(1) 16 x 20 x 1		(1) 20 x 20 x 1		(1) 20 x 25 x 1		
	mm	(1) 406 x 508 x 25		(1) 508 x 508 x 25		(1) 508 x 635 x 25		
Electrical characteristics		208/230v — 60 hz — 1 ph				208/230/460v 60 hz — 1 ph		
Shipping weight lbs. (kg)	Complete unit	149 (68)	149 (68)	176 (80)	178 (81)	240 (109)	242 (109)	
	Blower section	----	----	----	----	118 (54)	120 (54)	
	Coil section	----	----	----	----	122 (55)	122 (55)	
Number of packages in shipment		1	1	1	1	2	2	
◆ Optional Accessories (Must Be Ordered Extra) ◆								
Electric Heat Capacity	ECB19-2.5	*Output — Btuh (kW)	9,000 (2.6)	9,500 (2.8)	----	----	----	----
		†A.F.U.E.	99.8%	99.8%	----	----	----	----
	ECB19-5	*Output — Btuh (kW)	18,000 (5.3)	18,000 (5.3)	18,000 (5.3)	18,000 (5.3)	19,000 (5.6)	----
		†A.F.U.E.	99.7%	99.7%	99.9%	100%	100%	----
	ECB19-6	*Output — Btuh (kW)	21,000 (6.2)	22,000 (6.4)	22,000 (6.4)	22,000 (6.4)	23,000 (6.7)	----
		†A.F.U.E.	99.7%	99.7%	99.9%	100%	100%	----
	ECB19-7	*Output — Btuh (kW)	25,000 (7.3)	25,000 (7.3)	25,000 (7.3)	25,000 (7.3)	26,000 (7.6)	----
		†A.F.U.E.	99.7%	99.7%	99.9%	100%	100%	----
	ECB19-8	*Output — Btuh (kW)	28,000 (8.2)	28,000 (8.2)	29,000 (8.5)	29,000 (8.5)	29,000 (8.5)	30,000 (8.8)
		†A.F.U.E.	99.7%	99.7%	99.8%	100%	100%	100%
	ECB19-10	*Output — Btuh (kW)	35,000 (10.3)	35,000 (10.3)	35,000 (10.3)	35,000 (10.3)	36,000 (10.5)	37,000 (10.8)
		†A.F.U.E.	99.7%	99.7%	99.8%	99.9%	100%	100%
	ECB19-12.5	*Output — Btuh (kW)	----	44,000 (12.9)	44,000 (12.9)	44,000 (12.9)	45,000 (13.2)	46,000 (13.5)
		†A.F.U.E.	----	99.5%	99.7%	99.9%	100%	100%
	ECB19-15	*Output — Btuh (kW)	----	52,000 (15.2)	52,000 (15.2)	53,000 (15.5)	53,000 (15.5)	54,000 (15.8)
		†A.F.U.E.	----	99.5%	99.7%	99.9%	100%	100%
	ECB19-20	*Output — Btuh (kW)	----	----	----	70,000 (20.5)	70,000 (20.5)	71,000 (20.8)
		†A.F.U.E.	----	----	----	99.8%	99.8%	100%
ECB19-25	*Output — Btuh (kW)	----	----	----	----	87,000 (25.5)	88,000 (25.8)	
	†A.F.U.E.	----	----	----	----	99.8%	99.9%	
ECB19-30	*Output — Btuh (kW)	----	----	----	----	----	105,000 (30.8)	
	†A.F.U.E.	----	----	----	----	----	99.9%	

†Annual Fuel Utilization Efficiency based on U.S. DOE test procedures and according to FTC labeling regulations

††Filters are not furnished and must be ordered extra.

*Includes additional blower motor heat capacity.

BLOWER DATA

UP-FLOW SIDE RETURN AIR FILTER ADAPTOR RESISTANCE

Air Volume		Filter Resistance	
cfm	L/s	in. wg.	Pa
400	190	.01	2
600	285	.02	5
800	380	.03	7
1000	470	.05	12
1200	565	.08	20
1400	660	.08	20
1600	755	.08	20
1800	850	.09	22
2000	945	.09	22
2200	1040	.10	25
2400	1135	.10	25

BLOWER DATA

CB19-21 AND CBH19-21 BLOWER PERFORMANCE

External Static Pressure		Air Volume at Various Blower Speeds					
		High		Medium		Low	
in. wg.	Pa	cfm	L/s	cfm	L/s	cfm	L/s
0	0	855	405	630	295	530	250
.05	12	830	390	625	295	525	250
.10	25	800	380	620	295	520	245
.15	37	765	360	610	290	515	245
.20	50	730	345	595	280	505	240
.25	62	685	325	570	270	490	230
.30	75	640	300	535	250	465	220
.40	100	525	250	425	200	365	170

NOTE — All air data is measured external to unit.
Electric heaters have no appreciable air resistance.
For optional up-flow air filter resistance see separate table.

CB19-31 AND CBH19-31 BLOWER PERFORMANCE

External Static Pressure		Air Volume at Various Blower Speeds					
		High		Medium		Low	
in. wg.	Pa	cfm	L/s	cfm	L/s	cfm	L/s
0	0	1400	660	1270	600	1050	495
.05	12	1370	645	1250	590	1050	495
.10	25	1335	630	1220	575	1050	495
.15	37	1290	610	1190	560	1040	490
.20	50	1240	585	1150	545	1025	485
.25	62	1190	560	1110	525	1000	470
.30	75	1130	535	1060	500	970	460
.40	100	1000	470	945	445	885	420
.50	125	855	405	815	385	765	360

NOTE — All air data is measured external to unit.
Electric heaters have no appreciable air resistance.
For optional up-flow air filter resistance see separate table.

CB19-51 AND CBH19-51 BLOWER PERFORMANCE WITH 208/230 VOLT MOTOR

External Static Pressure		Air Volume at Various Blower Speeds					
		High		Medium		Low	
in. wg.	Pa	cfm	L/s	cfm	L/s	cfm	L/s
0	0	1950	920	1640	775	1380	650
.05	12	1910	900	1620	765	1370	645
.10	25	1870	880	1600	755	1350	635
.15	37	1830	865	1580	745	1330	630
.20	50	1780	840	1550	730	1310	620
.25	62	1730	815	1520	715	1290	610
.30	75	1680	795	1490	705	1260	595
.40	100	1570	740	1400	660	1200	565
.50	125	1410	665	1280	605	1100	520

NOTE — All air data is measured external to unit.
Electric heaters have no appreciable air resistance.
For optional up-flow air filter resistance see separate table.

CB19-65 AND CBH19-65 BLOWER PERFORMANCE WITH 208/230 VOLT MOTOR

External Static Pressure		Air Volume at Various Blower Speeds					
		High		Medium		Low	
in. wg.	Pa	cfm	L/s	cfm	L/s	cfm	L/s
0	0	2415	1140	2205	1040	1830	865
.05	12	2360	1115	2165	1020	1815	855
.10	25	2305	1090	2125	1005	1800	850
.15	37	2245	1060	2085	985	1780	840
.20	50	2185	1030	2040	965	1760	830
.25	62	2130	1005	2000	945	1735	820
.30	75	2070	975	1950	920	1705	805
.40	100	1940	915	1845	870	1630	770
.50	125	1810	855	1725	815	1540	725
.60	150	1665	785	1585	750	1405	665

NOTE — All air data is measured external to unit.
Electric heaters have no appreciable air resistance.
For optional up-flow air filter resistance see separate table.

CB19-26 AND CBH19-26 BLOWER PERFORMANCE

External Static Pressure		Air Volume at Various Blower Speeds					
		High		Medium		Low	
in. wg.	Pa	cfm	L/s	cfm	L/s	cfm	L/s
0	0	1150	545	1020	480	870	410
.05	12	1105	520	985	465	860	405
.10	25	1065	505	955	450	850	400
.15	37	1020	480	920	435	825	390
.20	50	960	455	875	415	795	375
.25	62	905	425	830	390	755	355
.30	75	845	400	780	370	710	335
.40	100	680	320	625	295	550	260

NOTE — All air data is measured external to unit.
Electric heaters have no appreciable air resistance.
For optional up-flow air filter resistance see separate table.

CB19-41 AND CBH19-41 BLOWER PERFORMANCE

External Static Pressure		Air Volume at Various Blower Speeds					
		High		Medium		Low	
in. wg.	Pa	cfm	L/s	cfm	L/s	cfm	L/s
0	0	1630	770	1380	650	1130	535
.05	12	1590	750	1370	645	1150	545
.10	25	1550	730	1350	635	1160	545
.15	37	1500	710	1330	630	1160	545
.20	50	1460	685	1310	620	1160	545
.25	62	1400	660	1270	600	1150	545
.30	75	1340	630	1230	580	1130	535
.40	100	1200	565	1130	535	1050	495
.50	125	1010	475	960	455	890	420

NOTE — All air data is measured external to unit.
Electric heaters have no appreciable air resistance.
For optional up-flow air filter resistance see separate table.

CB19-51 AND CBH19-51 BLOWER PERFORMANCE WITH 460 VOLT (1 phase) MOTOR

External Static Pressure		Air Volume at Various Blower Speeds			
		High		Low	
in. wg.	Pa	cfm	L/s	cfm	L/s
0	0	2020	955	1630	770
.05	12	1950	920	1610	760
.10	25	1920	905	1600	755
.15	37	1870	880	1570	740
.20	50	1820	860	1540	725
.25	62	1770	835	1500	710
.30	75	1710	805	1460	690
.40	100	1590	750	1350	635
.50	125	1430	675	1250	590

NOTE — All air data is measured external to unit.
Electric heaters have no appreciable air resistance.
For optional up-flow air filter resistance see separate table.

CB19-65 AND CBH19-65 BLOWER PERFORMANCE WITH 460 VOLT (1 phase) MOTOR

External Static Pressure		Air Volume at Various Blower Speeds			
		High		Low	
in. wg.	Pa	cfm	L/s	cfm	L/s
0	0	2380	1125	2250	1060
.05	12	2340	1105	2180	1030
.10	25	2290	1080	2140	1010
.15	37	2250	1060	2110	995
.20	50	2190	1035	2065	975
.25	62	2130	1005	2015	950
.30	75	2075	980	1970	930
.40	100	1945	920	1860	880
.50	125	1820	860	1760	830

NOTE — All air data is measured external to unit.
Electric heaters have no appreciable air resistance.
For optional up-flow air filter resistance see separate table.

ELECTRIC HEAT DATA — CB19/CBH19-21,-26

Blower Coil Unit Model Number	Electric Heat Model Number & Shipping Weight	Number of Steps & Phase	Volts Input	kW Input	**Btuh Input	●Blower Amps	*Minimum Circuit Ampacity	
							Circuit 1	Circuit 2
CB19-21 CBH19-21	ECB19-2.5 (68G86) 4 lbs. (2 kg)	1 step 1 phase	208	1.9	6,400	1.0	12.3	----
			220	2.1	7,200	1.0	12.8	----
			230	2.3	7,800	1.0	13.4	----
			240	2.5	8,500	1.0	13.9	----
	ECB19-5 (69G87) 4 lbs. (2 kg)	1 step 1 phase	208	3.8	12,800	1.0	23.5	----
			220	4.2	14,300	1.0	24.8	----
			230	4.6	15,700	1.0	25.9	----
			240	5.0	17,100	1.0	26.9	----
	ECB19-6 (69G88) 5 lbs. (2 kg)	2 steps 1 phase	208	4.5	15,400	1.0	28.0	----
			220	5.0	17,100	1.0	29.3	----
			230	5.5	18,800	1.0	30.9	----
			240	6.0	20,500	1.0	32.2	----
	ECB19-7 (69G89) 5 lbs. (2 kg)	2 steps 1 phase	208	5.3	17,900	1.0	32.5	----
			220	5.9	20,100	1.0	34.4	----
			230	6.4	21,900	1.0	35.8	----
			240	7.0	23,900	1.0	37.4	----
	ECB19-8 (69G90) 5 lbs. (2 kg)	2 steps 1 phase	208	6.0	20,500	1.0	37.0	----
			220	6.7	22,900	1.0	39.0	----
			230	7.3	25,100	1.0	40.8	----
			240	8.0	27,300	1.0	42.6	----
	ECB19-10 (69G91) 5 lbs. (2 kg)	2 steps 1 phase	208	7.5	25,600	1.0	45.9	----
			220	8.4	28,700	1.0	48.6	----
			230	9.2	31,400	1.0	50.8	----
			240	10.0	34,100	1.0	53.0	----
CB19-26 CBH19-26	ECB19-2.5 (69G86) 4 lbs. (2 kg)	1 step 1 phase	208	1.9	6,400	2.0	13.2	----
			220	2.1	7,200	2.0	13.7	----
			230	2.3	7,800	2.0	14.3	----
			240	2.5	8,500	2.0	14.8	----
	ECB19-5 (69G87) 4 lbs. (2 kg)	1 step 1 phase	208	3.8	12,800	2.0	24.4	----
			220	4.2	14,300	2.0	25.7	----
			230	4.6	15,700	2.0	26.8	----
			240	5.0	17,100	2.0	27.8	----
	ECB19-6 (69G88) 5 lbs. (2 kg)	2 steps 1 phase	208	4.5	15,400	2.0	28.9	----
			220	5.0	17,200	2.0	30.2	----
			230	5.5	18,800	2.0	31.8	----
			240	6.0	20,500	2.0	33.7	----
	ECB19-7 (69G89) 5 lbs. (2 kg)	2 steps 1 phase	208	5.3	17,900	2.0	33.4	----
			220	5.9	20,100	2.0	35.3	----
			230	6.4	21,900	2.0	36.7	----
			240	7.0	23,900	2.0	38.3	----
	ECB19-8 (69G90) 5 lbs. (2 kg)	2 steps 1 phase	208	6.0	20,500	2.0	37.9	----
			220	6.7	22,900	2.0	39.9	----
			230	7.3	25,100	2.0	41.7	----
			240	8.0	27,300	2.0	43.4	----
	ECB19-10 (69G91) 5 lbs. (2 kg)	2 steps 1 phase	208	7.5	25,600	2.0	46.8	----
			220	8.4	28,700	2.0	49.5	----
			230	9.2	31,400	2.0	51.7	----
			240	10.0	34,100	2.0	53.9	----
	ECB19-12.5 (69G92) 10 lbs. (5 kg)	3 steps 1 phase	208	9.4	32,000	2.0	39.4	18.9
			220	10.5	35,800	2.0	41.2	19.9
			230	11.5	39,200	2.0	43.4	20.8
			240	12.5	42,600	2.0	45.2	21.8
ECB19-15 (69G93) 10 lbs. (5 kg)	3 steps 1 phase	208	11.3	38,400	2.0	46.9	22.7	
		220	12.6	43,000	2.0	49.1	23.9	
		230	13.5	47,000	2.0	51.7	25.0	
		240	15.0	51,200	2.0	53.9	26.0	

*Refer to National or Canadian Electrical Code manual to determine wire, fuse and disconnect size requirements. Use wires suitable for at least 167°F (75°C).

**Electric heater capacity only — does not include additional blower motor heat capacity.

●Minimum circuit ampacity for blower motor only.

ELECTRIC HEAT DATA – CB19/CBH19-31,-41

Blower Coil Unit Model Number	Electric Heat Model Number & Shipping Weight	Number of Steps & Phase	Volts Input	kW Input	**Btuh Input	●Blower Amps	*Minimum Circuit Ampacity		
							Circuit 1	Circuit 2	
CB19-31 CBH19-31 and CB19-41 CBH19-41	ECB19-5 (69G87) 4 lbs. (2 kg)	1 step 1 phase	208	3.8	12,800	3.0	25.0	----	
			220	4.2	14,300	3.0	26.3	----	
			230	4.6	15,700	3.0	27.4	----	
			240	5.0	17,100	3.0	28.4	----	
	ECB19-6 (69G88) 5 lbs. (2 kg)	2 steps 1 phase	208	4.5	15,400	3.0	29.5	----	
			220	5.0	17,100	3.0	30.8	----	
			230	5.5	18,800	3.0	32.4	----	
	ECB19-7 (69G89) 5 lbs. (2 kg)	2 steps 1 phase	240	6.0	20,500	3.0	33.7	----	
			208	5.3	17,900	3.0	34.0	----	
			220	5.9	20,100	3.0	35.9	----	
	ECB19-8 (69G90) 5 lbs. (2 kg)	2 steps 1 phase	230	6.4	21,900	3.0	37.3	----	
			240	7.0	23,900	3.0	38.9	----	
			208	6.0	20,500	3.0	38.5	----	
	ECB19-10 (69G91) 5 lbs. (2 kg)	2 steps 1 phase	220	6.7	22,900	3.0	40.5	----	
			230	7.3	25,100	3.0	43.3	----	
			240	8.0	27,300	3.0	44.0	----	
			208	7.5	25,600	3.0	47.4	----	
	ECB19-12.5 (68G92) 10 lbs. (5 kg)	3 steps 1 phase	220	8.4	28,700	3.0	50.1	----	
			230	9.2	31,400	3.0	52.3	----	
			240	10.0	34,100	3.0	54.5	----	
			208	9.4	32,000	3.0	40.0	18.9	
	ECB19-15 (69G93) 10 lbs. (5 kg)	3 steps 1 phase	220	10.5	35,800	3.0	42.2	19.9	
			230	11.5	39,200	3.0	44.0	20.8	
			240	12.5	42,600	3.0	45.8	21.8	
			208	11.3	38,400	3.0	47.5	22.7	
	CB19-41 CBH19-41	ECB19-5 (69G97) 6 lbs. (3 kg)	3 steps 3 phase	220	12.6	43,000	3.0	50.1	23.9
				230	13.5	47,000	3.0	52.3	25.0
				240	15.0	51,200	3.0	54.5	26.0
208				11.3	38,400	3.0	47.5	22.7	
ECB19-7.5 (69G98) 6 lbs. (3 kg)		3 steps 3 phase	220	3.8	12,800	3.0	15.4	----	
			230	4.6	15,700	3.0	16.8	----	
			240	5.0	17,100	3.0	17.4	----	
			208	5.6	19,200	3.0	21.9	----	
ECB19-10 (69G99) 6 lbs. (3 kg)		3 steps 3 phase	220	6.3	21,500	3.0	23.0	----	
			230	6.9	23,500	3.0	24.0	----	
			240	7.5	25,600	3.0	24.9	----	
			208	7.5	25,600	3.0	28.4	----	
ECB19-15 (70G00) 9 lbs. (4 kg)		3 steps 3 phase	220	8.4	28,700	3.0	29.9	----	
			230	9.2	31,400	3.0	31.3	----	
			240	10.0	34,100	3.0	32.5	----	
			208	11.3	38,400	3.0	41.5	----	
ECB19-20 (69G94) 14 lbs. (6 kg)		3 steps 1 phase	220	12.6	43,000	3.0	43.7	----	
			230	13.5	47,000	3.0	45.7	----	
			240	15.0	51,200	3.0	47.5	----	
			208	15.0	51,200	3.0	47.4	45.0	
ECB19-20 (69G94) 14 lbs. (6 kg)	3 steps 1 phase	220	16.8	57,300	3.0	50.1	47.8		
		230	18.4	62,700	3.0	52.3	49.9		
		240	20.0	68,200	3.0	54.5	52.2		
		208	15.0	51,200	3.0	47.4	45.0		

*Refer to National or Canadian Electrical Code manual to determine wire, fuse and disconnect size requirements. Use wires suitable for at least 167°F (75°C).

**Electric heater capacity only — does not include additional blower motor heat capacity.

●Minimum circuit ampacity for blower motor only.

ELECTRIC HEAT DATA — CB19/CBH19-51

Blower Coil Unit Model Number	Electric Heat Model Number & Shipping Weight	Number of Steps & Phase	Volts Input	kW Input	**Btuh Input	●Blower Amps	*Minimum Circuit Ampacity		
							Circuit 1	Circuit 2	Circuit 3
CB19-51 CBH19-51	ECB19-5 (69G87) 4 lbs. (2 kg)	1 step 1 phase	208	3.8	12,800	3.0	25.7	----	----
			220	4.2	14,300	3.0	26.9	----	----
			230	4.6	15,700	3.0	28.0	----	----
			240	5.0	17,100	3.0	29.0	----	----
	ECB19-6 (69G88) 5 lbs. (2 kg)	2 steps 1 phase	208	4.5	15,400	3.0	30.2	----	----
			220	5.0	17,100	3.0	31.4	----	----
			230	5.5	18,800	3.0	33.0	----	----
			240	6.0	20,500	3.0	34.3	----	----
	ECB19-7 (69G89) 5 lbs. (2 kg)	2 steps 1 phase	208	5.3	17,900	3.0	34.7	----	----
			220	5.9	20,100	3.0	36.6	----	----
			230	6.4	21,900	3.0	37.9	----	----
			240	7.0	23,900	3.0	39.5	----	----
	ECB19-7 (70G03) 12 lbs. (5 kg)	3 steps 3 phase	440	5.9	20,100	3.0	11.3	----	----
			460	6.4	21,900	3.0	11.7	----	----
			480	7.0	25,900	3.0	12.2	----	----
	ECB19-7.5 (69G98) 6 lbs. (3 kg)	3 steps 3 phase	208	5.6	19,200	3.0	22.5	----	----
			220	6.3	21,500	3.0	23.7	----	----
			230	6.9	23,500	3.0	24.7	----	----
			240	7.5	25,600	3.0	25.5	----	----
	ECB19-8 (69G90) 5 lbs. (2 kg)	2 steps 1 phase	208	6.0	20,500	3.0	39.2	----	----
			220	6.7	22,900	3.0	41.1	----	----
			230	7.3	25,100	3.0	42.9	----	----
			240	8.0	27,300	3.0	44.7	----	----
	ECB19-10 (69G91) 5 lbs. (2 kg)	2 steps 1 phase	208	7.5	25,600	3.0	48.0	----	----
			220	8.4	28,700	3.0	50.8	----	----
			230	9.2	31,400	3.0	52.9	----	----
			240	10.0	34,100	3.0	55.2	----	----
	ECB19-10 (69G99) 6 lbs. (3 kg)	3 steps 3 phase	208	7.5	25,600	3.0	29.0	----	----
			220	8.4	28,700	3.0	30.6	----	----
			230	9.2	31,400	3.0	31.9	----	----
			240	10.0	34,100	3.0	33.2	----	----
	ECB19-10 (70G04) 12 lbs. (5 kg)	3 steps 3 phase	440	8.4	28,700	2.0	15.4	----	----
			460	9.2	31,400	2.0	16.1	----	----
			480	10.0	34,100	2.0	16.7	----	----
			208	9.4	32,000	3.0	40.7	18.9	----
	ECB19-12.5 (68G92) 10 lbs. (5 kg)	3 steps 1 phase	220	10.5	35,800	3.0	42.8	19.9	----
			230	11.5	39,200	3.0	44.7	20.8	----
			240	12.5	42,600	3.0	46.4	21.8	----
			208	11.3	38,400	3.0	48.2	22.7	----
	ECB19-15 (69G93) 10 lbs. (5 kg)	3 steps 1 phase	220	12.6	43,000	3.0	50.8	23.9	----
230			13.5	47,000	3.0	52.9	25.0	----	
240			15.0	51,200	3.0	55.2	26.0	----	
208			11.3	38,400	2.0	42.2	----	----	
ECB19-15 (70G00) 9 lbs. (4 kg)	3 steps 3 phase	220	12.6	43,000	2.0	44.3	----	----	
		230	13.5	47,000	2.0	46.3	----	----	
		240	15.0	51,200	2.0	48.2	----	----	
		440	12.6	43,000	2.0	22.3	----	----	
ECB19-15 (70G05) 12 lbs. (5 kg)	3 steps 3 phase	460	13.8	47,000	2.0	23.3	----	----	
		480	15.0	51,200	2.0	24.2	----	----	
		208	15.0	51,200	3.0	48.0	45.0	----	
ECB19-20 (69G94) 14 lbs. (6 kg)	4 steps 1 phase	220	16.8	57,300	3.0	50.8	47.8	----	
		230	18.4	62,700	3.0	52.9	49.9	----	
		240	20.0	68,200	3.0	55.2	52.2	----	
		208	15.0	51,200	2.0	29.0	26.0	----	
ECB19-20 (70G01) 19 lbs. (9 kg)	6 steps 3 phase	220	16.8	57,300	2.0	30.6	27.6	----	
		230	18.4	62,700	2.0	31.9	28.9	----	
		240	20.0	68,200	2.0	33.2	30.2	----	
		440	16.8	57,300	2.0	29.2	----	----	
ECB19-20 (70G06) 18 lbs. (8 kg)	6 steps 3 phase	460	18.4	62,700	2.0	30.5	----	----	
		480	20.0	68,200	2.0	31.7	----	----	
		208	18.8	64,100	2.0	48.0	45.0	22.7	
ECB19-25 (69G95) 18 lbs. (8 kg)	5 steps 1 phase	220	21.0	71,700	2.0	50.8	47.8	23.9	
		230	23.0	78,300	2.0	52.9	49.9	25.0	
		240	25.0	85,300	2.0	55.2	52.2	26.0	

*Refer to National or Canadian Electrical Code manual to determine wire, fuse and disconnect size requirements. Use wires suitable for at least 167°F (75°C).
 **Electric heater capacity only — does not include additional blower motor heat capacity.
 ●Minimum circuit ampacity for blower motor only.

ELECTRIC HEAT DATA – CB19/CBH19-65

Blower Coil Unit Model Number	Electric Heat Model Number & Shipping Weight	Number of Steps & Phase	Volts Input	kW Input	**Btuh Input	●Blower Amps	*Minimum Circuit Ampacity		
							Circuit 1	Circuit 2	Circuit 3
CB19-65 CBH19-65	ECB19-8 (69G90) 5 lbs. (2 kg)	2 steps 1 phase	208	6.0	20,500	6.0	41.7	----	----
			220	6.7	22,900	6.0	43.6	----	----
			230	7.3	25,100	6.0	45.4	----	----
			240	8.0	27,300	6.0	47.2	----	----
	ECB19-10 (69G91) 5 lbs. (2 kg)	2 steps 1 phase	208	7.5	25,600	6.0	50.5	----	----
			220	8.4	28,700	6.0	53.3	----	----
			230	9.2	31,400	6.0	55.4	----	----
			240	10.0	34,100	6.0	57.7	----	----
	ECB19-10 (69G99) 12 lbs. (5 kg)	3 steps 3 phase	208	7.5	25,600	6.0	31.5	----	----
			220	8.4	28,700	6.0	33.1	----	----
			230	9.2	31,400	6.0	34.4	----	----
			240	10.0	34,100	6.0	35.7	----	----
	ECB19-10 (70G04) 6 lbs. (3 kg)	3 steps 3 phase	440	8.4	28,700	3.0	16.2	----	----
			460	9.2	31,400	3.0	16.8	----	----
			480	10.0	34,100	3.0	17.4	----	----
	ECB19-12.5 (69G92) 10 lbs. (5 kg)	3 steps 1 phase	208	9.4	32,000	6.0	43.2	18.9	----
			220	10.5	35,800	6.0	45.3	19.9	----
			230	11.5	39,200	6.0	47.2	20.8	----
			240	12.5	42,600	6.0	48.9	21.8	----
	ECB19-15 (69G93) 10 lbs. (5 kg)	3 steps 1 phase	208	11.3	38,400	6.0	50.7	22.7	----
			220	12.6	43,000	6.0	53.3	23.9	----
			230	13.5	47,000	6.0	55.4	25.0	----
			240	15.0	51,200	6.0	57.7	26.0	----
	ECB19-15 (70G00) 9 lbs. (4 kg)	3 steps 3 phase	208	11.3	38,400	6.0	44.7	----	----
			220	12.6	43,000	6.0	46.8	----	----
			230	13.5	47,000	6.0	48.8	----	----
			240	15.0	51,200	6.0	50.7	----	----
	ECB19-15 (70G05) 12 lbs. (5 kg)	3 steps 3 phase	440	12.6	43,000	3.0	23.0	----	----
			460	13.8	47,000	3.0	24.0	----	----
			480	15.0	51,200	3.0	24.9	----	----
	ECB19-20 (69G94) 14 lbs. (6 kg)	4 steps 1 phase	208	15.0	51,200	6.0	50.5	45.0	----
			220	16.8	57,300	6.0	53.3	47.8	----
			230	18.4	62,700	6.0	55.4	49.9	----
			240	20.0	68,200	6.0	57.7	52.2	----
	ECB19-20 (70G01) 19 lbs. (9 kg)	6 steps 3 phase	208	15.0	51,200	6.0	31.5	26.0	----
			220	16.8	57,300	6.0	33.1	27.6	----
			230	18.4	62,700	6.0	34.4	28.9	----
			240	20.0	68,200	6.0	35.7	30.2	----
	ECB19-20 (70G06) 18 lbs. (8 kg)	6 steps 3 phase	440	16.8	57,300	3.0	29.9	----	----
			460	18.4	62,700	3.0	31.2	----	----
480			20.0	68,200	3.0	32.4	----	----	
ECB19-25 (69G95) 18 lbs. (8 kg)	5 steps 1 phase	208	18.8	64,100	6.0	50.5	45.0	22.7	
		220	21.0	71,700	6.0	53.3	47.8	23.9	
		230	23.0	78,300	6.0	55.4	49.9	25.0	
		240	25.0	85,300	6.0	57.7	52.2	26.0	
ECB19-25 (70G02) 19 lbs. (9 kg)	6 steps 3 phase	208	18.8	64,100	6.0	38.2	32.7	----	
		220	21.0	71,700	6.0	39.9	34.4	----	
		230	23.0	78,300	6.0	41.5	36.0	----	
		240	25.0	85,300	6.0	43.2	37.7	----	
ECB19-25 (70G07) 18 lbs. (8 kg)	6 steps 3 phase	440	21.0	71,700	3.0	36.8	----	----	
		460	23.0	78,300	3.0	38.4	----	----	
		480	25.0	85,300	3.0	39.9	----	----	
ECB19-30 (69G96) 19 lbs. (9 kg)	6 steps 1 phase	208	22.5	76,900	6.0	50.5	45.0	45.0	
		220	25.2	86,000	6.0	53.3	47.8	47.8	
		230	27.5	94,000	6.0	55.4	49.9	49.9	
		240	30.0	102,400	6.0	57.7	52.2	52.2	

*Refer to National or Canadian Electrical Code manual to determine wire, fuse and disconnect size requirements. Use wires suitable for at least 167°F (75°C).

**Electric heater capacity only — does not include additional blower motor heat capacity.

●Minimum circuit ampacity for blower motor only.

DIMENSIONS – inches (mm)

CB19 UP-FLOW POSITION

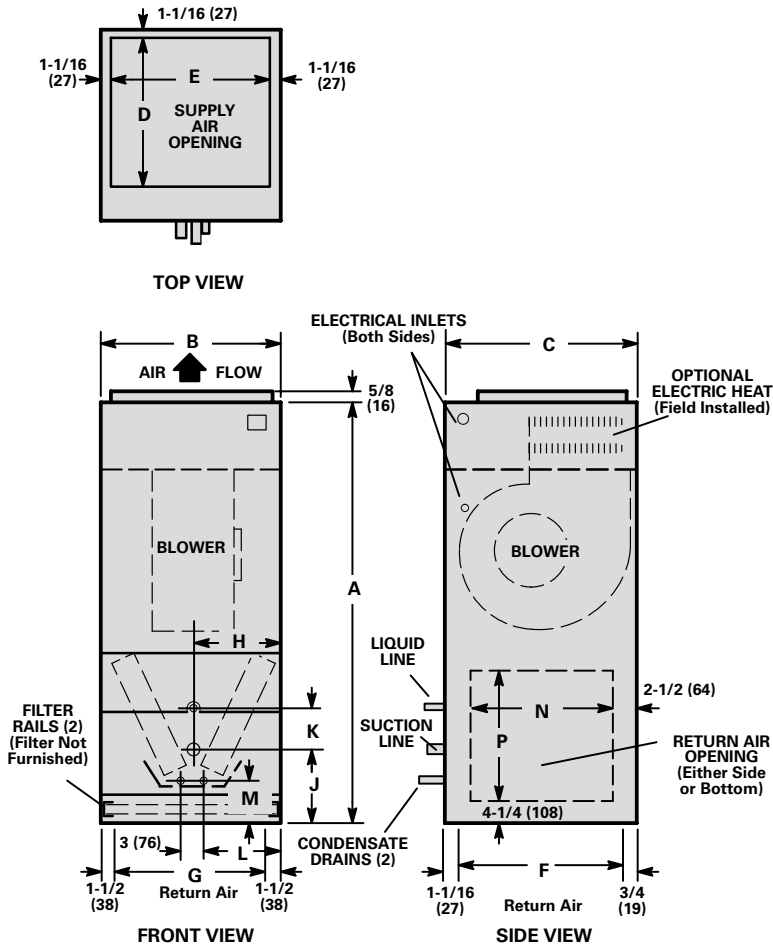

Model No.	CB19-21 & -26		CB19-31 & -41		CB19-51 & -65	
	inch	mm	inch	mm	inch	mm
A	48	1219	51	1295	60	1524
B	18-1/4	464	21-1/2	546	23-1/4	591
C	23-1/4	591	23-1/4	591	25-1/4	641
D	18	457	18	457	20	508
E	15-7/8	403	19-1/8	486	20-7/8	530
F	21-7/16	545	21-7/16	545	23-7/16	595
G	15	381	18-1/4	464	20	508
H	9-1/8	232	10-3/4	273	11-5/8	295
J	7-7/16	189	10-5/16	262	11-11/16	297
K	5-1/4	133	5-1/4	133	10	254
L	7-9/16	192	9-3/16	233	10-1/16	256
M	5-5/8	143	5-3/16	132	7-11/16	195
N	18-1/4	464	18-1/4	464	20-1/4	514
P	14-1/4	362	18-1/4	464	25-1/4	641

CB19 DOWN-FLOW POSITION

NOTE – When unit with optional electric heat is installed on a combustible floor, an additive base is required. Base is optional and must be ordered extra. When using additive base make opening in floor 2-3/8 inches (60mm) larger (side to side) and 2-1/2 inches (64mm) larger (front to rear) than unit supply air opening.

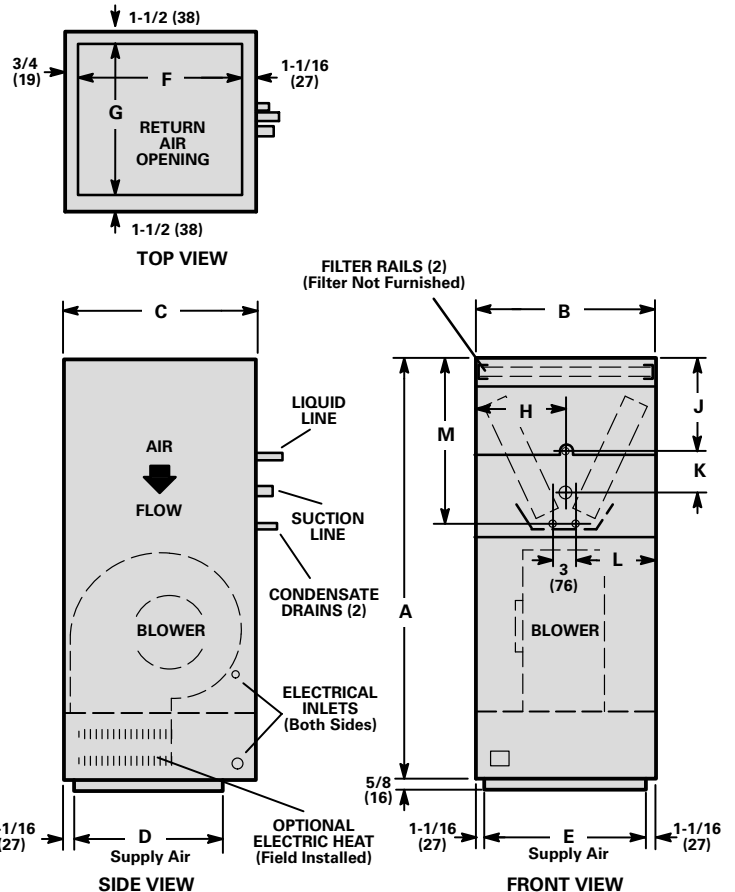

Model No.	CB19-21 & -26		CB19-31 & -41		CB19-51 & -65	
	inch	mm	inch	mm	inch	mm
A	48	1219	51	1295	60	1524
B	18-1/4	464	21-1/2	546	23-1/4	591
C	23-1/4	591	23-1/4	591	25-1/4	641
D	18	457	18	457	20	508
E	15-7/8	403	19-1/8	486	20-7/8	530
F	21-7/16	545	21-7/16	545	23-7/16	595
G	15	381	18-1/4	464	20	508
H	9-1/8	232	10-3/4	273	11-5/8	295
J	8-15/16	227	12-3/4	324	11-7/18	302
K	5-1/4	133	5-1/4	133	10	254
L	7-9/16	192	9-3/16	233	10-1/16	256
M	9-3/16	233	22	559	25-7/8	657

DIMENSIONS – inches (mm)

UP-FLOW SIDE RETURN AIR FILTER ADAPTOR (CB19-21,-26,-31 and -41)

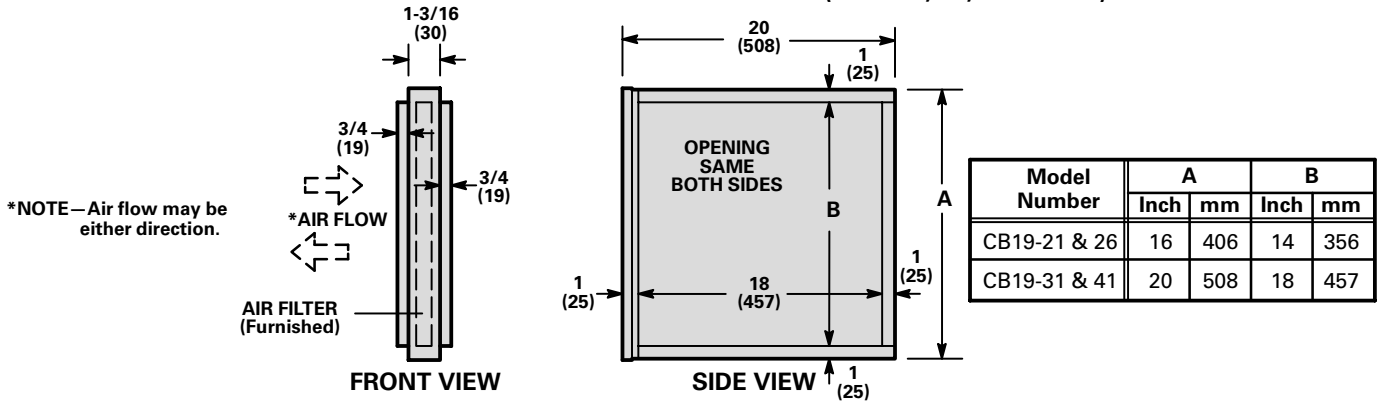

UP-FLOW SIDE RETURN AIR FILTER ADAPTOR (CB19-51 and -65)

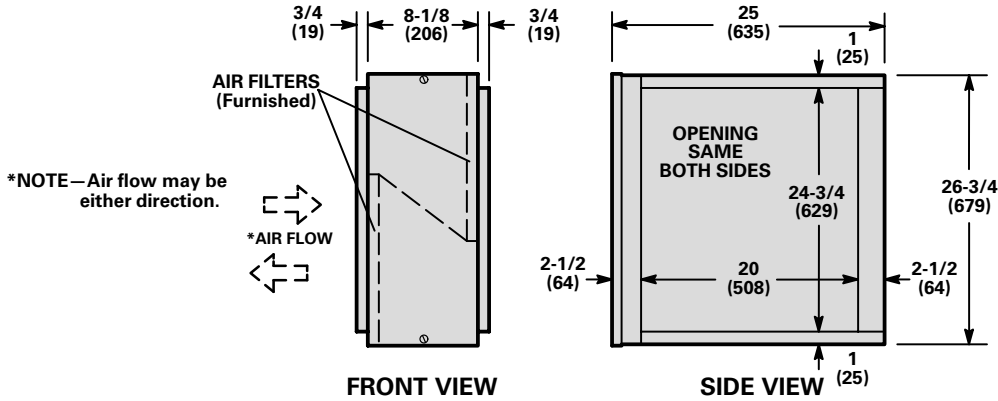

CBH19-21,-26,-31 and -41 HORIZONTAL MODELS

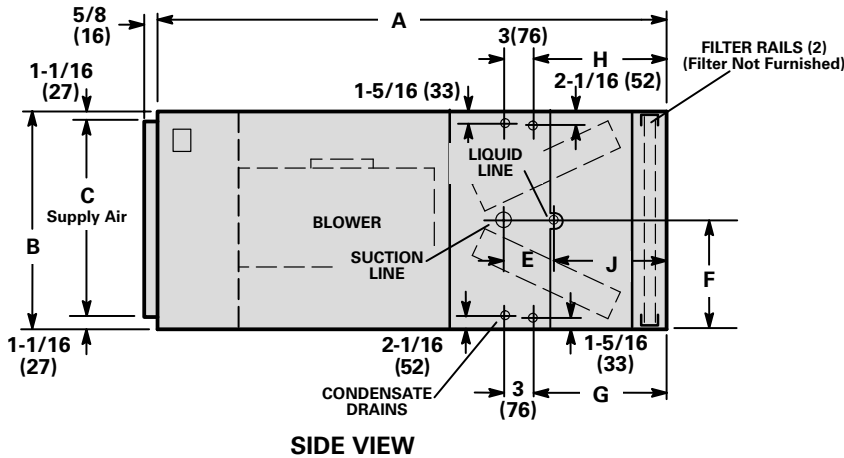
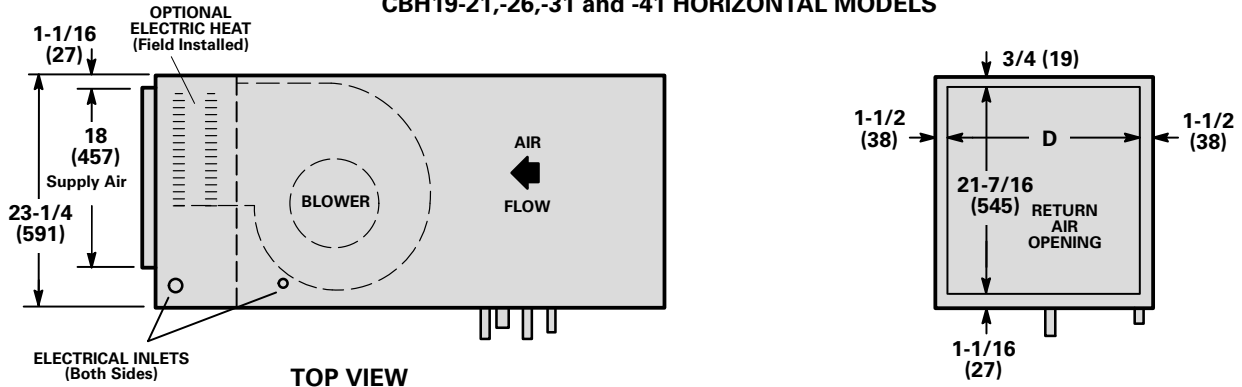

NOTE – Units are shipped with left hand air discharge. For right hand air discharge, turn unit over (end for end) and reposition coil.

Model Number	A		B		C		D		E		F		G		H		J	
	in.	mm	in.	mm	in.	mm	in.	mm	in.	mm	in.	mm	in.	mm	in.	mm	in.	mm
CBH19-21,-26	48	1219	18-1/4	464	15-7/8	403	15	381	4-1/2	144	9-1/8	232	13-1/8	333	10-1/16	256	8-15/16	227
CBH19-31,-41	51	1295	21-1/2	546	19-1/8	486	18-1/2	470	4-1/4	108	10-3/4	273	15	381	12	305	13-3/4	337

B19-51 and B19-65 BLOWER SECTION

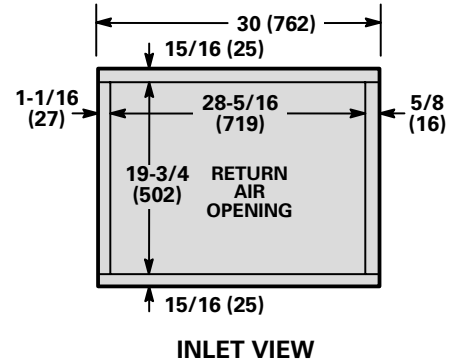
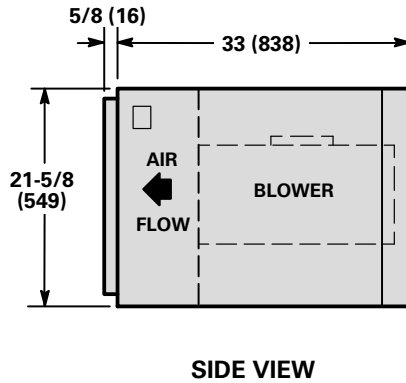
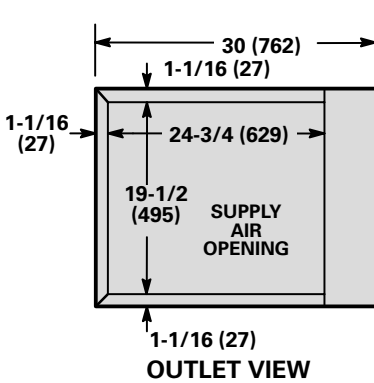
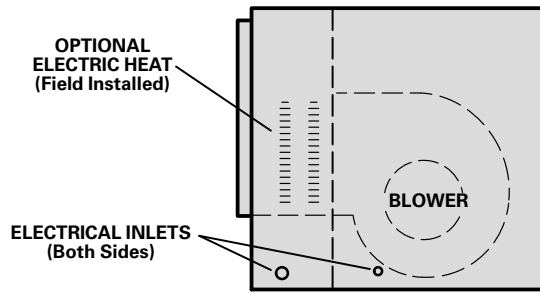

CH19-51 and CH19-65 COIL SECTION

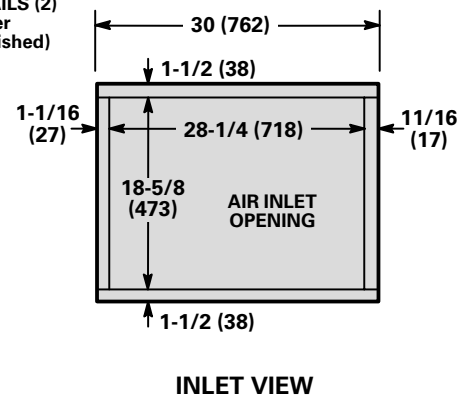
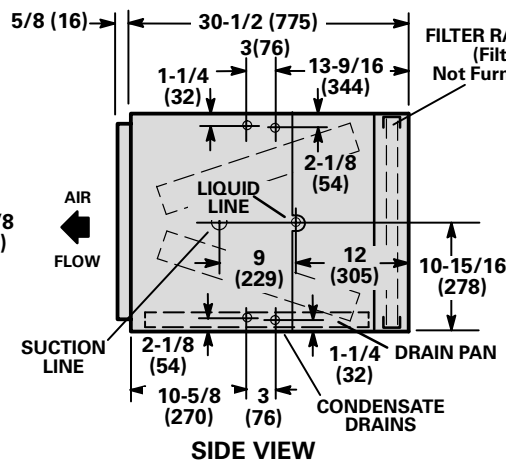
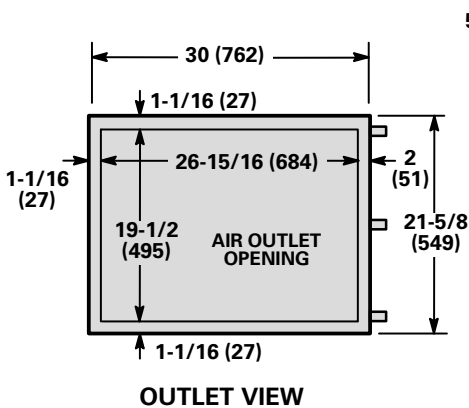

CBH19-51 and -65 HORIZONTAL MODELS

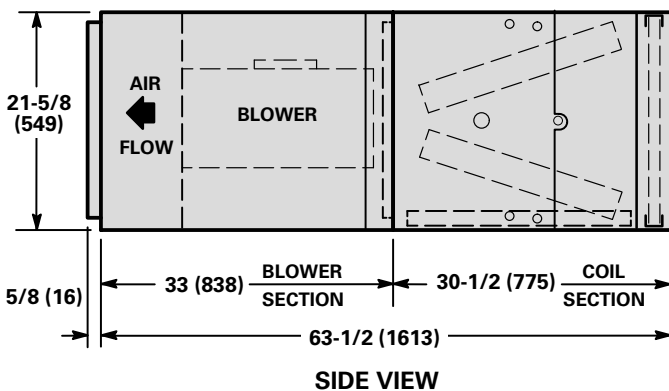

INSTALLATION CLEARANCES — ALL MODELS

Cabinet	0 inch (0 mm)
Plenum and Outlet duct on blower/coil units	1 inch (25 mm)
Plenum and Warm air duct within 3 feet (914mm) of cabinet	1 inch (25 mm)
Floor	*Combustible

*When unit is installed in the down-flow position with electric heat on a combustible floor an optional down-flow base is required.

NOTE — Units are shipped with left hand air discharge. For right hand air discharge, turn unit over (end for end) and reposition coil.