

This Owner's Manual is provided and hosted by [Appliance Factory Parts](#).



PRESTO 0134108 Owner's Manual

[Shop genuine replacement parts for PRESTO 0134108](#)



[Find Your PRESTO Pressure Cooker Parts - Select From 250 Models](#)

----- Manual continues below -----

PRESTO®

Pressure Cookers

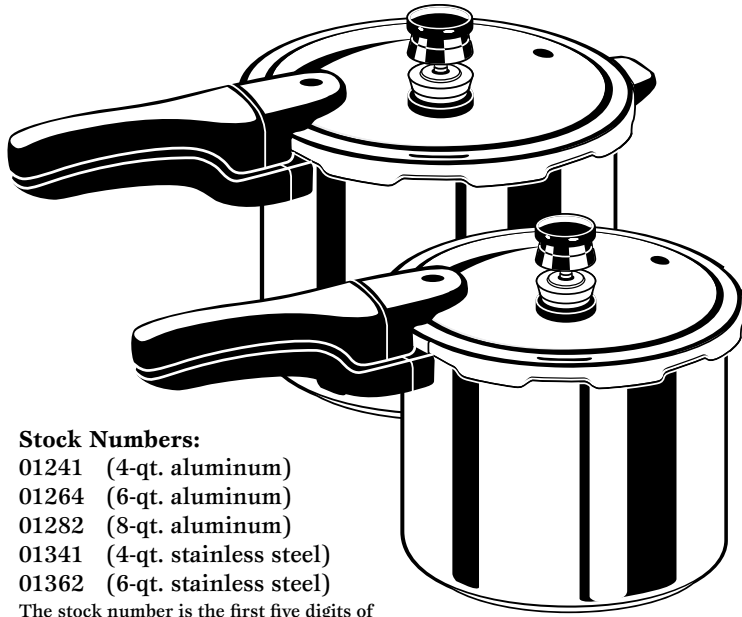

Stock Numbers:

01241 (4-qt. aluminum)

01264 (6-qt. aluminum)

01282 (8-qt. aluminum)

01341 (4-qt. stainless steel)

01362 (6-qt. stainless steel)

The stock number is the first five digits of the model number.



Visit us on the web at
www.GoPresto.com

©2009 by National Presto Industries, Inc.

Instructions and Recipes

This is a  Listed appliance. The following Important Safeguards are recommended by most portable appliance manufacturers.

IMPORTANT SAFEGUARDS

To reduce the risk of personal injury or property damage, basic safety precautions should always be followed, including the following:

1. **Read all instructions.**
2. Be sure that handles are assembled and fastened properly before using this appliance (see pages 4 and 5). Cracked, broken or charred handles should be replaced.
3. Always check the vent pipe before use. Hold cover up to light and look through vent pipe to be certain it is clear.
4. Always check the air vent/cover lock to be sure it moves freely before use.
5. Do not fill pressure cooker over $\frac{2}{3}$ full. For soup, grains, and dry beans and peas which expand during cooking, do not fill cooker over $\frac{1}{2}$ full. Overfilling may cause a risk of clogging the vent pipe and developing excess pressure. See food preparation instructions.
6. Do not pressure cook applesauce, cranberries, rhubarb, cereals, pastas, dried soup mixes, or any dry beans and peas which are not listed on the chart on page 54. These foods tend to foam, froth, and sputter and may block the vent pipe, overpressure plug, and air vent/cover lock.
7. This appliance cooks under pressure. Improper use may result in scalding injury. Make certain pressure cooker is properly closed before operating; cover handle must be directly above the body handle. See "How To Use Instructions."
8. Do not place the pressure cooker or attempt to pressure cook in a heated oven.
9. Extreme caution must be used when moving a pressure cooker containing hot liquids. Do not touch hot surfaces. Use handles or knobs.
10. Do not open pressure cooker until the unit has cooled and all internal pressure has been released, air vent/cover lock has dropped, and no steam escapes when the pressure regulator is removed. If the handles are difficult to push apart, this indicates that the cooker is still pressurized – do not force it open. Any pressure in the cooker can be hazardous. See "How To Use Instructions."
11. **Caution:** To ensure safe operation and satisfactory performance, replace the overpressure plug every time you replace the sealing ring or sooner if it becomes hard, deformed, cracked, worn, or pitted. It is recommended that the sealing ring and overpressure plug be replaced at least every two years.

12. Close supervision is necessary when the pressure cooker is used near children. It is not recommended that children use the pressure cooker.
13. When normal operating pressure is reached, the pressure regulator will begin to rock. Gradually lower the heat to maintain a slow, steady rocking motion. If the pressure regulator is allowed to rock vigorously excess steam will escape, liquid will be evaporated, and food may scorch.
14. Caution: Do not use pressure cooker on an outdoor LP gas burner or gas range over 12,000 BTU's.
15. Do not use this pressure cooker for other than intended use.
16. Do not use this pressure cooker for pressure frying with oil.

SAVE THESE INSTRUCTIONS

THIS PRODUCT IS FOR HOUSEHOLD USE ONLY.

PRESTO®

Pressure Cooker

Instructions and Recipes

TABLE OF CONTENTS

Important Safeguards	Inside front cover
Introduction	3
Handle Installation	4
Getting Acquainted.	6
How to Use	8
Important Safety Information.	12
Cleaning	15
Care and Maintenance	17
Helpful Hints	19
Questions and Answers.	21
Soups and Stocks	24
Seafood.	29
Poultry	33
Meats	39
Vegetables	46
Dry Beans and Peas	53
Grains	56
Desserts	60
Recipe Index.	64
Service and Parts Information	65
Warranty	Back cover

INTRODUCTION

Welcome to the world of pressure cooking. With your new Presto® Pressure Cooker, you'll discover how fast and easy it is to prepare a wide variety of delicious foods—especially foods that emphasize good health and nutrition along with good taste.

The pressure cooker is perfect for the way we live and eat today. It's ideal for preparing many of the lighter foods that help keep us healthy and fit. It preserves flavors and nutrients, tenderizes meat and, best of all, it cooks foods three to ten times faster than ordinary cooking methods. And, it's even possible to cook several foods in the pressure cooker at the same time without the flavors intermingling.

We have included recipes for some traditional family favorites that are especially well suited to the many advantages of pressure cooking. For your convenience, we have also provided nutritional information for all of the recipes in this book.

To help get started with your new pressure cooker, be sure to read the "GETTING ACQUAINTED" section beginning on page 6.

HANDLE INSTALLATION

Tools Required: Phillips type screwdriver

NOTE: The pressure cooker handles can be found inside the pressure cooker body in individual plastic bags.

To Attach Helper Handle to Cooker Body

(Does not apply to 4-quart pressure cooker, stock number 01241.)

1. Place pressure cooker body upside down on table or counter (Fig. A).
2. Locate bag containing short helper handle. Take out handle and remove tape on handle which is holding screw in place. Remove screw from handle and set aside.
3. Position helper handle, with indented side facing up, onto threaded post under fill lines (Fig. A). Insert screw into helper handle hole and using a Phillips type screwdriver fasten handle securely to post. When properly installed, handle should appear level with table or counter as shown in Fig. A.

Caution: Overtightening can result in stripping of screws or cracking of handles.

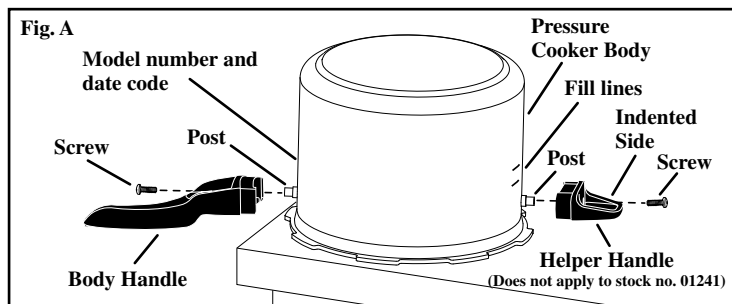

To Attach Body Handle to Cooker Body

1. Locate bag containing long body handle. This is the handle that has one screw hole. Take out handle and remove tape on handle which is holding screw in place. Remove screw from handle and set aside.

2. For easier handle installation, position cooker body so the threaded post extends over edge of counter slightly.
3. Position long body handle, with ▲ facing down, onto threaded post which is under model number and date code (Fig. A).
4. Insert screw into handle hole and using a Phillips type screwdriver fasten handle securely to post. **Caution:** Overtightening can result in stripping of screws or cracking of handles.

To Attach Cover Handle to Cooker Cover

1. Locate bag containing cover handle. This handle has three holes, two of which contain screws. Take out handle and remove tape on handle which is holding the two screws in place. Remove screws from handle and set aside.
2. Place pressure cooker cover upside down on table or counter as shown in Fig. B, so vent pipe bottom faces you.
3. Fit cover handle, with the indented side facing up, onto cover handle mount so the air vent cover lock stem fits through the center hole of the cover handle (Fig. B).
4. Insert the screws into the two holes on both sides of the center hole. Using a Phillips type screwdriver fasten cover handle securely to cover handle mount. **Caution:** Overtightening can result in stripping of screws or cracking of handles.

Note: As noted in step 4 on page 9, the cooker is completely closed when the cover handle is directly above the body handle. After placing cover on cooker body, check positioning of handles.

When properly installed the body handle and cover handle will line up with each other without interference.

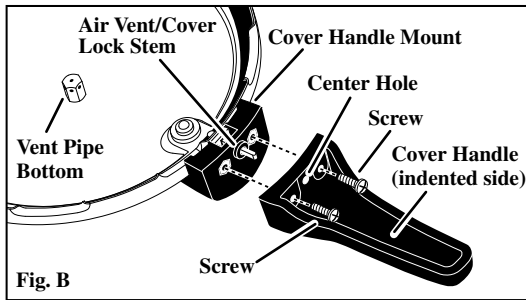

GETTING ACQUAINTED

Your pressure cooker is like a saucepan with a very special cover that locks in place. Air is automatically exhausted and steam is sealed inside creating pressure within the unit. Under pressure, internal temperatures in the cooker are raised above the normal boiling point of water, causing foods to cook faster. At 15 pounds of pressure, a temperature of 250° F. (or 121° C.) is reached inside the pressure cooker. These higher temperatures speed cooking, and the moist steam atmosphere tenderizes meats naturally.

It is important to become familiar with the various parts of the pressure cooker (Fig. C) and to read the "HOW TO USE" section beginning on page 8 before using the unit for the first time.

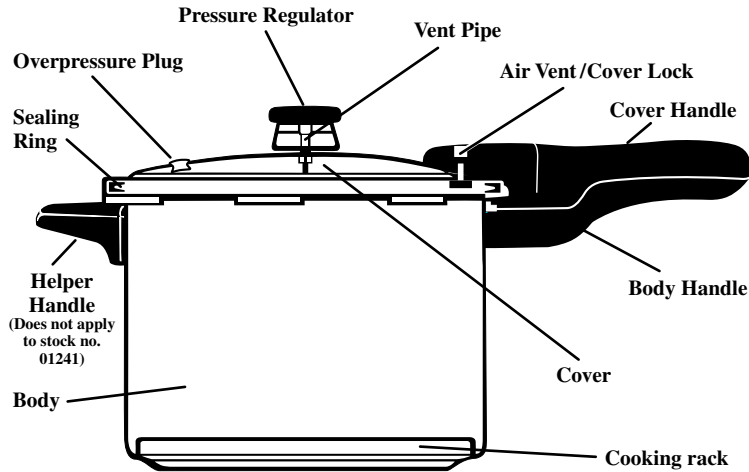
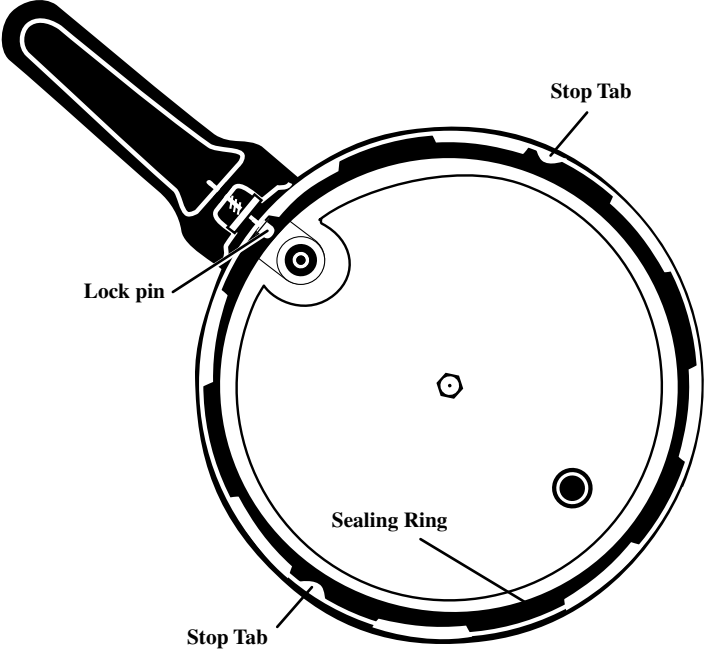

Fig. C

Before the first use, remove the sealing ring (Fig. D) by simply pulling it out of the inside rim of the cover.

Wash sealing ring, cover, body, and cooking rack (Fig. C) in hot, sudsy water to remove any packaging material and white manufacturing lubricant. Rinse all parts with warm water and dry. Then, replace the sealing ring, being careful to fit it under the stop tabs and the lock pin (Fig. D) which are located on the inside rim of the cover.

Fig. D



HOW TO USE

To assure the very best results every time, carefully follow these step-by-step instructions for pressure cooking. You may find it helpful to refer back to Fig. C on page 6.

1. Prepare ingredients according to the directions in the pressure cooking recipe you have selected. Recipes in this book were developed for use in a 4-quart pressure cooker. If you have a 6-quart pressure cooker, you may increase the ingredients by $\frac{1}{2}$. If you have an 8-quart pressure cooker, you may double the ingredients. Be sure not to overfill the pressure cooker (see page 12 for guidance on filling).

Pour liquid into the cooker body, as specified in the recipe or timetable. This liquid is usually water. However, some recipes will call for other liquids, such as wine.

2. Place the cooking rack into the cooker, if called for in the recipe (see Helpful Hints on page 19 for guidance on when to use).

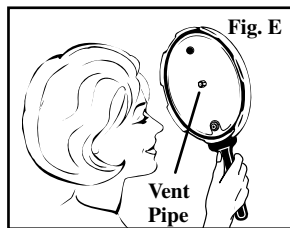

3. **IMPORTANT:** Look through the vent pipe to make certain that it is clear (Fig. E) before placing cover on cooker body. See safety information on page 13.

Holding the body handle with your left hand and the cover handle with your right hand, align the **V** (or **▼**) mark on the cover with the

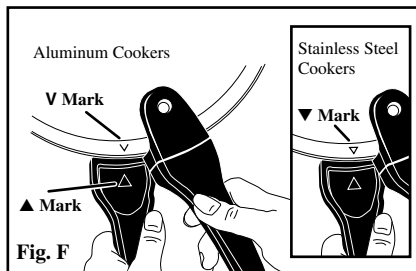

▲ mark on the body handle and place the cover on the cooker body (Fig. F). Aluminum cookers have a ▼ mark on the cover and stainless steel cookers have a ▼ mark on the cover.

4. After placing the cover on the cooker body, place one hand on the cover opposite the body handle and apply a slight downward pressure. Place the thumb of your other hand on the side of the body handle and wrap your fingers around the cover handle (Fig. G). Then rotate the cover clockwise until the cover handle lines up with the body handle.

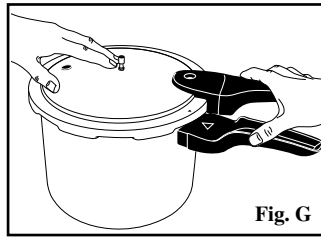

The pressure cooker is completely closed when the cover handle is directly above the body handle (Fig. H).

5. Place the pressure regulator on the vent pipe (Fig. I). The pressure regulator will fit loosely on the vent pipe. It will not touch the top of the pressure cooker cover.

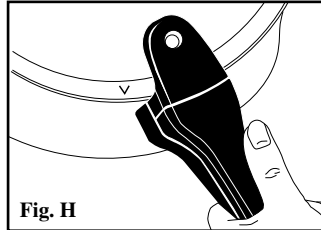

6. Using a high heat setting on your stove, heat the pressure cooker until the pressure regulator attains a gentle rocking motion.

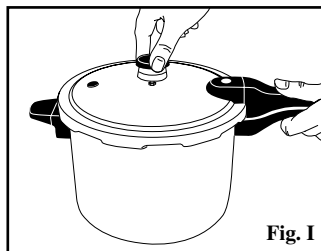

NOTE: The air vent/cover lock may move up and down a few times when cooking first begins as it automatically exhausts air from the pressure cooker. Steam will be noticeable. This is normal. When pressure begins to build, it slides up, lock-

ing the cover on. Once the cooker has sealed, the air vent/cover lock will remain in the up position until pressure is released (Fig. J).

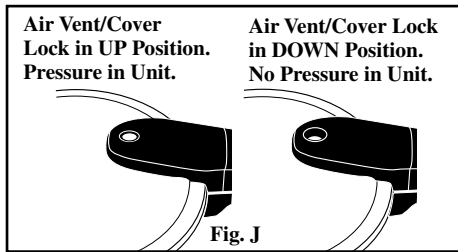

7. Cooking time begins when the pressure regulator begins to rock gently. Gradually lower the heat as necessary to maintain a slow, steady rocking motion and cook for the length of time indicated in the recipe or timetable. If the pressure regulator is allowed to rock vigorously, excess steam will escape. Therefore, too much liquid will evaporate and food may scorch. Never leave your pressure cooker unattended at high heat settings. It could boil dry, overheat, and cause damage to the pressure cooker.
8. When cooking time is complete, turn off burner. If using an electric stove, remove pressure cooker from burner. **Caution: Lift pressure cooker to remove it from burner. Sliding cookware can leave scratches on stovetops.**
9. Reduce pressure according to the recipe or timetable instructions. If the instructions say "Let the pressure drop of its own

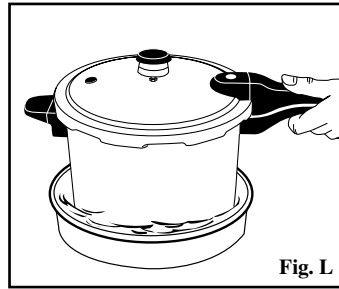
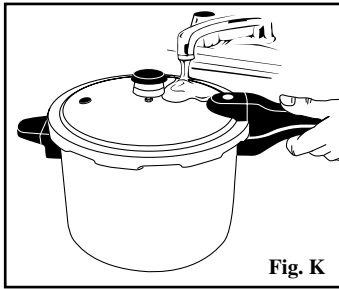

accord,” set the pressure cooker aside to cool until pressure is completely reduced. If the instructions state, “Cool cooker at once,” cool the pressure cooker under a running water faucet (Fig. K) or pour cold water over it, or place it in a pan of cold water (Fig. L) until pressure is completely reduced. **Note: Do not set hot cooker in a molded sink as it could damage the sink.** Pressure is completely reduced when the air vent/cover lock has dropped.

If the air vent/cover lock remains in its raised position, there is still pressure inside the pressure cooker. Continue to cool until the air vent/cover lock drops.

10. After pressure has been completely reduced, remove the pressure regulator. **Always remove the pressure regulator before opening the cover.**
11. To open the cover, turn it counterclockwise until the **V** (or **▼**) mark on the cover aligns with the **▲** mark on the body handle. Then, lift the cover toward you to keep any steam away from you. If the cover turns hard, there still may be some pressure in the unit. **Do not force the cover off.** Continue to cool the pressure cooker until steam no longer is escaping from the vent pipe, the air vent/cover lock has dropped, and the cover turns easily.
12. Food is ready to serve.

IMPORTANT SAFETY INFORMATION

Cooking under pressure enables you to prepare food both quickly and deliciously. If used properly, your pressure cooker is one of the safest appliances in your kitchen. To ensure safe operation, make sure you always observe the following simple rules whenever you use the pressure cooker:

1. **Never overfill the pressure cooker.** — The pressure regulator is designed to maintain cooking pressure at a safe level. It relieves excess pressure through the vent pipe as it rocks back and forth. Many foods tend to expand when cooked. If the cooker is overfilled, expansion of food may cause the vent pipe to become blocked or clogged. If the vent pipe becomes blocked, it cannot relieve excess pressure.

Do not fill the cooker above the $\frac{2}{3}$ fill line when cooking most foods. When cooking foods that foam, froth, or expand, such as rice, grains, dry beans and peas, or foods that are mostly liquid, such as soups, never fill the cooker above the $\frac{1}{2}$ fill line.

For your convenience, both the $\frac{2}{3}$ and $\frac{1}{2}$ full levels are marked by indentations on the side of the pressure cooker body (Fig. M). The upper marking indicates the $\frac{2}{3}$ full level and the lower the $\frac{1}{2}$ full level. In addition, in each section of the recipes you will find instructions on the maximum fill level for each type of food.

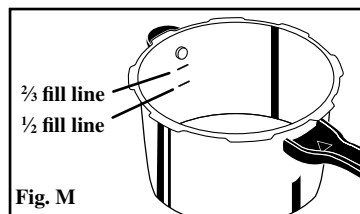

Fig. M

Reminder: When cooking any food, do not let any portion extend above the maximum fill mark. When cooking rice, grains, dry beans and peas, soups, and stews, the cooker should never be more than ½ full.

2. **Always add cooking liquid.** — If an empty pressure cooker is left on a hot burner or if a cooker boils dry and is left on a heated burner, the cooker will overheat excessively causing possible discoloration and/or damage to the cooker.
3. **Always look through the vent pipe before using the cooker to make sure it is clear.** — If the vent pipe is blocked, it cannot function as it should and thus cannot relieve excess pressure. Pressure may then build to unsafe levels. To clean the vent pipe, see page 15.
4. **Always fully close the pressure cooker.** — The cooker is fully closed when the cover handle is directly above the body handle. Your pressure cooker has specially designed lugs on the cover and body which lock the cover in place when the cooker is fully closed. However, if the cooker is not fully closed, the lugs cannot lock the cover onto the body. It's possible that pressure could build inside the cooker and cause the cover to come off and result in bodily injury or property damage. Always be sure the cover handle is directly above the body handle (see page 9, Fig. H). Do not turn past handle alignment.
5. **Never open the cooker when it contains pressure.** — The air vent/cover lock provides a visual indication of pressure inside the cooker. When it is up, there is pressure. When it is down, there is no pressure in the cooker and it can be opened. If the pressure cooker is opened before all of the pressure is released, the contents of the cooker will erupt and could cause bodily injury or property damage.

6. **Replace the overpressure plug if it is hard, deformed, cracked, worn or pitted, or when replacing the sealing ring. Replace the sealing ring if it becomes hard, deformed, cracked, worn, pitted, or soft and sticky.** — The overpressure plug is a secondary pressure relief valve which is designed to relieve excess pressure by releasing from the cooker cover in the event that the vent pipe becomes blocked. The overpressure plug is made of rubber, and when new, is soft and pliable. Over time, depending on the frequency and type of use, rubber becomes hard and inflexible. When hard and inflexible, the overpressure plug loses its ability to act as a secondary pressure relief valve. It should be replaced immediately.

Should the overpressure plug ever be forced out of the cover due to excess pressure while cooking, it is important to call the Test Kitchen at 1-800-368-2194. **Do not attempt to use the released overpressure plug.**

7. **Always follow special procedures found in the instruction book when pressure cooking rice, grains, and dry beans and peas.** — During cooking, dry beans and peas tend to froth and foam which could cause the vent pipe to become blocked. Therefore, dry beans and peas need to be soaked and cooked according to instructions beginning on page 53. Using this method will keep foam at safe levels during cooking. Like dry beans and peas, rice and grains tend to froth and foam during cooking; therefore, to contain foaming and frothing during the cooking period, rice and grains must be prepared in a bowl in the pressure cooker according to directions on page 56.
8. **Never pressure cook applesauce, cranberries, rhubarb, cereals, pastas, dried soup mixes, or dry beans and peas which are not listed in the chart on page 54.** — These foods expand so much as a result of foaming and frothing that they should never be cooked under pressure.

CLEANING

1. All parts of your pressure cooker, including the sealing ring and pressure regulator, are fully immersible for easy cleaning. When washing the unit, however, the sealing ring should always be removed to allow easy cleaning of the inside rim of the cover. The sealing ring should be washed with hot, sudsy water after each use.

2. To be sure the vent pipe is clear, hold the cover up to the light and look through the vent pipe. Clean it with a small brush or pipe cleaner if it is blocked or partially blocked (Fig. N). Also clean the vent pipe nut as shown.

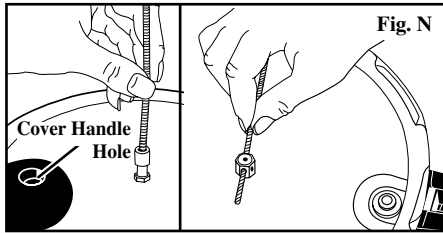

3. Occasionally remove the air vent/cover lock in the pressure cooker cover handle for cleaning. To remove the air vent/cover lock, place your finger over the hole in the cover handle (Fig. N) and remove the white rubber gasket from the air vent/cover lock on the underside of the cover (Fig. O). Push the air vent/cover lock through the top of the cover and wash it and the gasket in hot, sudsy water. The metal shaft of the air vent/cover lock may be cleaned with a nylon mesh pad. Clean the hole in the cover handle with a small brush. After cleaning, reinsert the metal shaft of the air vent/cover lock from the top side of the cover down

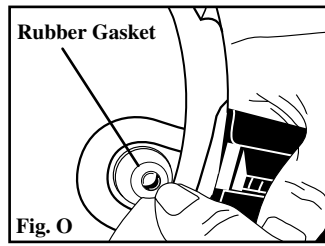

through the cover handle hole (Fig. P). Place a finger over the handle hole (to keep the cover lock from falling out) and turn the cover over. Wet the rubber gasket and push onto the end of the metal shaft until it snaps into the groove on the shaft.

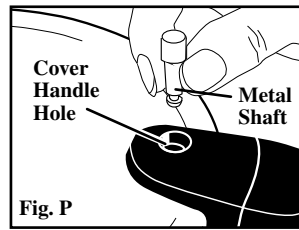

4. The overpressure plug can also be removed for cleaning by pushing it out of its opening from the top of the cover. After cleaning, reinsert it by pushing the domed side of the plug into the opening from the underside of the cover, until the bottom edge is fully and evenly seated against the underside of the cover (Fig. Q). When the overpressure plug is properly installed, the word (TOP) will be visible on the overpressure plug when viewing the outside of the cover.

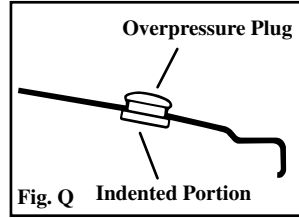

Special Cleaning Instructions for Aluminum Cookers:

1. Iron and other minerals in water and foods may darken the inside of your aluminum cooker. This discoloration will not affect the food cooked in the unit. These stains can be removed by using a solution of water and cream of tartar. Use a tablespoon of cream of tartar for each quart of water and pour enough solution into the cooker to cover the discoloration (do not fill over $\frac{2}{3}$ full). Close the cover securely, place the pressure regulator on the vent pipe, and heat until the pressure regulator rocks gently. Remove the cooker from the heat and allow it to stand for two to three hours. Remove the pressure regulator and discard the contents. Scour thoroughly with a soap impregnated steel wool pad; wash, rinse, and dry.

2. The outside surface of aluminum pressure cookers may be cleaned with a good silver polish if necessary. Staining may result if the cooker is washed in the dishwasher. If food residue adheres to the pressure cooker body, clean with a nylon mesh pad, a fine steel wool pad, or a fine kitchen cleanser.

Special Cleaning Instructions for Stainless Steel Cookers:

1. If food residue adheres to the pressure cooker body, clean with a stainless steel scouring pad, a nylon mesh pad, or a non-abrasive powder cleanser, such as Bon ami* polishing cleanser or Cameo* copper, brass & porcelain cleaner. Do not use steel wool or cleaners with chlorine bleach.

Your stainless steel pressure cooker may also be washed in an automatic dishwasher. When washing in a dishwasher, you must first remove the sealing ring and overpressure plug from the cover as these parts must be hand washed.

2. To bring out its luster, the outside surface of your stainless steel pressure cooker can be cleaned occasionally with a silver polish or any other fine, non-abrasive polish.

Take care not to overheat your stainless steel pressure cooker. Very high heat can sometimes cause vari-colored stains, called heat tints, in stainless steel. Heat tints can usually be removed by using a non-abrasive powder cleanser.

CARE AND MAINTENANCE

1. When not in use, store your pressure cooker in a dry place with the cover inverted on the body. If the cover is locked on, unpleasant odors may form inside the unit and the sealing ring could be damaged.
2. As is the case of all cookware, avoid chopping or cutting food inside the cooker with a knife or other sharp utensil.

*Bon ami polishing cleanser is a registered trademark of Faultless Starch/Bon Ami Co.
Cameo copper, brass & porcelain cleaner is a registered trademark of Church & Dwight Co., Inc.

3. If the body or cover handles become loose, tighten them with a screwdriver. CAUTION: Overtightening can result in stripping of screws or cracking of handles and legs.
4. Do not strike the rim of the pressure cooker with any cooking utensil because this could cause nicks in the rim which may allow steam to escape and prevent the pressure cooker from sealing.
5. The sealing ring, overpressure plug, and rubber gasket of the air vent/cover lock may shrink, become hard, deformed, cracked, worn, or pitted with normal use. Exposure to high heat, such as a warm burner or oven top, will cause these parts to deteriorate rapidly. When this happens, replace the sealing ring, overpressure plug, and small rubber gasket of the air vent/cover lock. Replace the sealing ring and overpressure plug at least every two years.

Leakage between the cover and body is usually caused by shrinkage of the sealing ring after prolonged use. Replace the sealing ring. Whenever you replace the sealing ring, replace the overpressure plug also.

6. Each time you clean or use your pressure cooker, check to be sure the bottom has not been damaged. Nicks and scratches may leave sharp edges that can damage ceramic stovetops or other smooth surfaces. Lift pressure cooker to remove it from burner. Sliding cookware could leave scratches on stovetops.
7. The formation of a small amount of moisture under the pressure regulator is normal when cooking first begins. It is the result of the temperature of the regulator being lower than the rest of the unit.

A small amount of steam or moisture may also be visible around the overpressure plug and air vent/cover lock as cooking begins. It should stop when pressure begins to build and the overpressure plug and air vent/cover lock seal. If leakage continues, clean or replace the overpressure plug and/or air

vent/cover lock assembly. The pressure cooker will not seal if the gasket for the air vent/cover lock is cracked.

Do not operate your pressure cooker with continual leakage. If the preceding steps do not correct the problem, return the entire unit to the Presto Factory Service Department (see page 65).

8. If for any reason the pressure cooker cannot be opened, contact the Consumer Service Department in Eau Claire, WI at 1-800-877-0441.

Any maintenance required for this product, other than normal household care and cleaning, should be performed by the Presto Factory Service Department (see page 65).

HELPFUL HINTS

- ◆ Your favorite recipes may be adjusted for cooking in the pressure cooker by following the general directions in this book for the particular type of food being cooked. Decrease the cooking time for your recipe by $\frac{2}{3}$ since pressure cooking is much faster than ordinary cooking methods. For example, if your ordinary cooking method requires 45 minutes, in the pressure cooker the cooking time will be 15 minutes. Because there is very little evaporation, the amount of liquid used should be decreased. Use about $\frac{1}{2}$ cup more liquid than you'll desire in your finished dish. But, remember, there must always be water or some other liquid in the pressure cooker to produce the necessary steam.
- ◆ Use the cooking rack when it is desirable to cook foods out of the cooking liquid. When foods are pressure cooked out of the liquid, flavors will not intermingle. Therefore, it is possible to cook several foods at once, as long as they have similar cooking times. If it is desirable to blend flavors, do not use the cooking rack.

- ◆ Many different cooking liquids can be used in a pressure cooker. Wine, beer, bouillon, fruit juices, and of course water all make excellent cooking liquids in the pressure cooker.
- ◆ Beautiful desserts and side dishes can be prepared in the pressure cooker, using individual or small metal molds or glass custard cups, which are ovenproof. Fill molds $\frac{2}{3}$ full to allow for expansion of food, and fit them loosely into the pressure cooker on the cooking rack. Do not fill the pressure cooker over $\frac{2}{3}$ full.
- ◆ If a recipe says to cook 0 minutes, cook food only until the pressure regulator begins to rock. Then cool pressure cooker according to recipe.
- ◆ The pressure cooker is usually cooled at once for delicate foods such as custards and fresh vegetables. For other foods, like meats, soups, and grains, let the pressure drop of its own accord.
- ◆ When pressure cooking at high altitudes, the cooking time needs to be increased 5% for every 1000 feet above the first 2000 feet. Following this rule, the times should be increased as follows:

3000 ft. ... 5%	5000 ft. ... 15%	7000 ft. ... 25%
4000 ft. ... 10%	6000 ft. ... 20%	8000 ft. ... 30%

Because pressure cooking times are increased at altitudes of 3,000 feet or above, an additional $\frac{1}{2}$ cup cooking liquid will be needed.

- ◆ If you have any questions on recipes, time charts, or the operation of your pressure cooker, call or write: Test Kitchen, National Presto Industries, Inc., 3925 North Hastings Way, Eau Claire, Wisconsin 54703-3703, phone 1-800-368-2194. You may also contact us at our website www.GoPresto.com. When writing, please include a phone number and a time

when you can be reached during weekdays, if possible.
Written inquiries will be answered promptly by letter or telephone.

QUESTIONS & ANSWERS

Occasionally the cover is hard to open or close. What causes this? What should I do?

In order for pressure to build inside your pressure cooker, the unit has a special cover which provides an airtight fit. Because of this, you may find that on occasion the cover may be difficult to open or close. The following suggestions will help if this happens:

If the cover seems hard to close, press the palm of your hand on the cover area directly opposite the cover handle while moving the cover handle to the closed position with your other hand.

If after browning meat or poultry the cover is difficult to close, it may be due to expansion of the pressure cooker body from heating. Remove the cover and allow the pressure cooker body to cool slightly and try again. Do not place the pressure cooker back on the burner until it is fully closed.

If necessary, to help make the cover easier to open and close, a very light coating of cooking oil may be applied to the sealing ring and to the underside of the lugs on the pressure cooker body (Fig. R). Use a pastry

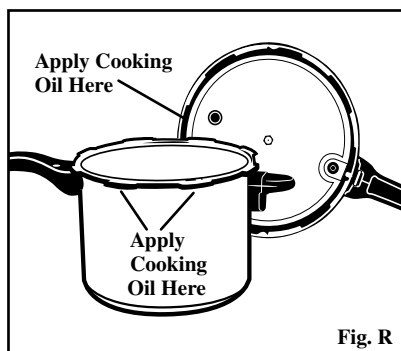

Fig. R

brush, a piece of cloth, or your fingertips and be sure to wipe off any excess oil.

What can be done if the food prepared in the pressure cooker has more liquid than desired?

With the cover removed, simmer to evaporate the excess liquid. Next time you prepare the same recipe, you may want to use less liquid.

How does one prevent overcooking?

Remember to begin timing as soon as the pressure regulator begins to rock gently. It is very important to accurately time the cooking period. A Presto® kitchen timer is very helpful for this purpose. Also be sure to follow the recipe instructions for cooling the pressure cooker.

What if the food is not completely done after the recommended cooking time?

Simply bring the cooker back up to pressure and cook the food a minute or two longer.

Can I use my pressure cooker on all types of ranges?

Your pressure cooker will work on gas, electric coil and ceramic glass (smoothtop) ranges. In addition, stainless steel pressure cookers will work on induction ranges. However, because aluminum pressure cookers are not magnetic, they will not work on induction ranges.

When cooking first begins, is it normal for steam to escape and moisture to form on the cover and between the handles?

It is normal for steam to escape and a slight amount of moisture leakage to form on the cover and between the handles when cook-

ing first begins. If leakage continues, the cover handle may not be properly aligned with the body handle and, therefore, the cover lock cannot engage.

Is it normal for the air vent/cover lock to rise up partially and drop back down when cooking first begins?

It is possible that the air vent/cover lock will move up and down slightly when cooking first begins. Do not be concerned. The air vent/cover lock will remain in the up position once the cooker has sealed. However, if the air vent/cover lock continues to move up and down or rises partially, tap it lightly with the tip of a knife.

If it does not rise once you have tapped it, the following may be occurring:

1. The burner is not hot enough.
2. The cooker is not fully closed (see page 9).
3. There is insufficient liquid to form steam.
4. The gasket for the air vent/cover lock needs to be replaced (see page 18).

SOUPS AND STOCKS

The pressure cooker is perfect for preparing delicious, nourishing soups and stocks in minutes instead of the hours taken by ordinary methods.

Stocks form the base for most great soups and sauces, and you can even substitute a stock for water in many recipes to add extra flavor. Traditionally, stocks are made by simmering bones and scraps for hours to extract all their flavor. With the pressure cooker, you can do the same thing in just minutes by following the simple directions on the following pages.

We've also included a few favorite soup recipes and, if you have a favorite recipe of your own, try it in the pressure cooker using one of the recipes in this book as your guide. If adding dry beans and peas, they must first be soaked according to directions on page 53. **Do not pressure cook soups containing barley, rice, pasta, grains, dry beans and peas which are not listed in the chart on page 54, and dried soup mixes** because they have a tendency to foam, froth, and sputter and could block the vent pipe.

Cooked barley, rice, grains, pasta, dry beans and peas which are not listed in the chart on page 54, and dried soup mixes should be added to the soup after pressure cooking.

**FOR SOUPS AND STOCKS,
DO NOT FILL PRESSURE COOKER OVER 1/2 FULL!**

**OPERATING THE COOKER WITHOUT COOKING LIQUID OR
ALLOWING THE COOKER TO BOIL DRY WILL DAMAGE THE COOKER.**

CHICKEN SOUP

1½ pounds chicken, cut into serving pieces	½ cup chopped onion
4 cups water	¼ cup chopped celery
½ cup sliced carrots	1 teaspoon salt
	¼ teaspoon black pepper

Place all ingredients in cooker. Close cover securely. Place pressure regulator on vent pipe and **cook 12 minutes with pressure regulator rocking slowly. Let pressure drop of its own accord.** Remove pieces of chicken from cooker and let cool. Remove meat from bones and return meat to cooker. Heat through.

Nutrition Information Per Serving *4 servings*
160 Calories, 8 g Fat, 54 mg Cholesterol

Delicious Soups From Chicken Soup...

CHICKEN SOUP STOCK — Strain Chicken Soup to make stock.

CHICKEN NOODLE SOUP — Bring soup to a boil. Add fine noodles and simmer, uncovered, 10 to 15 minutes. Salt and pepper to taste.

6 servings

CHICKEN DUMPLING SOUP — Mix together 1 beaten egg, ½ cup milk, and ½ teaspoon salt. Stir in 1⅛ cups flour. Drop mixture from teaspoon into bubbling Chicken Soup in cooker. Simmer uncovered 6 minutes.

6 servings

CHICKEN RICE SOUP — Add 1 cup cooked rice to Chicken Soup. Heat through. Salt and pepper to taste.

6 servings

BROWN BEEF SOUP

1½ pounds lean beef, cut into 1-inch cubes	¼ cup chopped celery
4 cups water	1 bay leaf
½ cup chopped onion	1 teaspoon parsley flakes
½ cup sliced carrots	1 teaspoon salt
	¼ teaspoon black pepper

Place all ingredients in cooker. Close cover securely. Place pressure regulator on vent pipe and **cook 12 minutes with pressure regulator rocking slowly. Let pressure drop of its own accord.**

Nutrition Information Per Serving *4 servings*
295 Calories, 15 g Fat, 110 mg Cholesterol

Delicious Soups From Brown Beef Soup...

BROWN BEEF SOUP STOCK — Strain Brown Beef Soup to make stock.

ONION SOUP — Pour 2 tablespoons vegetable oil into cooker and sauté 1½ cups thinly sliced onions. Stir onions into 6 cups Brown Beef Soup Stock in cooker. Season with ¼ teaspoon pepper. Close cover securely. Place pressure regulator on vent pipe and **cook 2 minutes with pressure regulator rocking slowly. Let pressure drop of its own accord.** Ladle into soup bowls. Top with Parmesan cheese. If desired, garnish with croutons or toasted French bread.

6 servings

BEEF TOMATO SOUP — Add 2 cups tomato juice and 1 cup cooked rice to Brown Beef Soup. Heat through.

8 servings

BLACK BEAN SOUP

- | | |
|-------------------------------------|-----------------------------------|
| 2 cups dry black beans | 2 cups sliced carrots, |
| 1 tablespoon olive or | ¾-inch thick |
| vegetable oil | 1 tablespoon packed brown |
| 1 cup chopped onion | sugar |
| 3 cloves garlic, minced | 2 teaspoons white wine |
| 1-2 jalapeño chiles, seeded, | vinegar |
| deveined, minced | •••••••• |
| 1 tablespoon chili powder | 1 cup loosely packed fresh |
| 1½ teaspoons oregano | cilantro, chopped |
| ½ teaspoon allspice | Salt to taste |
| 4 cups chicken stock or | |
| broth | |

Soak beans according to instructions on page 53. Pour oil in pressure cooker. Sauté onion, garlic, chiles, chili powder, oregano, and allspice for 2 minutes. Stir in beans, chicken stock, carrots, brown sugar, and vinegar. Close cover securely. Place pressure regulator on vent pipe and **cook 12 minutes with pressure regulator rocking slowly. Let pressure drop of its own accord.** Remove 1 cup of bean mixture, place in blender and purée until smooth. Return to pressure cooker and stir in fresh cilantro.

Nutrition Information Per Serving
231 Calories, 3 g Fat, 0 mg Cholesterol

8 servings

SAFFRON FISH STEW

- | | |
|---|---|
| 1 can (14½ ounces) chicken broth | ••••••• |
| ¼ cup dry white wine | 1 pound firm fish (halibut, haddock, cod, pollack) fresh or thawed, cut into 8 pieces |
| 4 new red potatoes, quartered | 1 small red pepper, cut into chunks |
| 3 carrots, cut into ½-inch chunks | 1 cup frozen peas, thawed |
| 1 medium onion, finely chopped | |
| 2 cloves garlic, minced | |
| ¼ cup chopped parsley | |
| 1 bay leaf | |
| Pinch of saffron threads or ¼ teaspoon turmeric | |

Place broth, wine, potatoes, carrots, onion, garlic, parsley, bay leaf, and saffron in pressure cooker. Close cover securely. Place pressure regulator on vent pipe and **cook 2 minutes with pressure regulator rocking slowly. Cool cooker at once.** Add fish, pepper, and peas. Close cover securely. Place pressure regulator on vent pipe and **cook 1 minute with pressure regulator rocking slowly. Cool cooker at once.** Discard bay leaf.

Nutrition Information Per Serving
174 Calories, 1 g Fat, 40 mg Cholesterol

8 servings

MINISTRONE

- | | |
|--|--|
| 1 pound lean beef, cut into 1-inch cubes | 1½ teaspoons basil |
| 5 cups water | 1 teaspoon salt |
| 1 can (14-15 ounces) diced tomatoes | 1 bay leaf |
| ½ cup chopped onion | ¼ teaspoon black pepper |
| 1 cup sliced carrots | ••••••• |
| ¼ cup chopped celery | 1 can (16 ounces) Great Northern beans |
| 1 clove garlic, minced | 1 can (15 ounces) cut green beans, drained |
| 2 tablespoons parsley flakes | 2 ounces fine noodles |

Place beef, water, tomatoes, onions, carrots, celery, garlic, parsley, basil, salt, bay leaf, and pepper in cooker. Close cover securely. Place pressure regulator on vent pipe and **cook 10 minutes with pressure regulator rocking slowly. Let pressure drop of its own accord.** Add Great Northern beans, green beans, and noodles. Simmer uncovered 10 minutes. Garnish with Parmesan cheese, if desired.

Nutrition Information Per Serving
234 Calories, 6 g Fat, 44 mg Cholesterol

10 servings

POTATO SOUP

- | | | | |
|---|-----------------------------|--------|----------------------------|
| 1 | tablespoon vegetable oil | ¼ | teaspoon basil |
| 1 | cup finely chopped onions | •••••• | |
| ½ | cup finely sliced celery | 1 | can (12 ounces) evaporated |
| 3 | cups chicken broth | | skim milk |
| 4 | cups peeled, diced potatoes | | Salt to taste |
| ¼ | teaspoon white pepper | | |

Heat oil in pressure cooker over medium heat. Sauté onion and celery until soft. Add broth, potatoes, pepper, and basil to pressure cooker. Close cover securely. Place pressure regulator on vent pipe and **cook 5 minutes with pressure regulator rocking slowly. Let pressure drop of its own accord.** Remove 2 cups of potato mixture; place in blender or food processor and process until smooth. Return to pressure cooker and stir in evaporated milk.

Nutrition Information Per Serving
160 Calories, 2 g Fat, 2 mg Cholesterol

6 servings

ZESTY HOMEMADE CHILI

- | | | | |
|----|-----------------------------|--------|---------------------------|
| 1½ | pounds ground beef | 1 | teaspoon ground cumin |
| 1 | can (8 ounces) tomato sauce | ½ | teaspoon black pepper |
| ½ | cup water | ½ | teaspoon oregano |
| 1 | cup chopped onion | ¼ | teaspoon cayenne pepper |
| ¾ | cup chopped green pepper | •••••• | |
| 2 | cloves garlic, minced | 1 | can (15 ounces) kidney |
| 1 | tablespoon chili powder | | beans, drained and rinsed |
| 1 | teaspoon salt | | |

Turn heat selector to medium and brown meat. Add remaining ingredients except kidney beans. Close cover securely. Place pressure regulator on vent pipe and **cook 5 minutes with pressure regulator rocking slowly. Let pressure drop of its own accord.** Stir in kidney beans and heat through.

Nutrition Information Per Serving
432 Calories, 17 g Fat, 111 mg Cholesterol

4 servings

SEAFOOD

Seafood is the basis of some of the healthiest and most nutritious meals you can make. It is an excellent source of protein, a good source of minerals, and one of the few sources of beneficial omega-3 fatty acids.

Steaming in the pressure cooker brings out the finest, fullest flavors of seafood. The cooking time required is directly related to the thickness of the seafood. To be safe, if the fish you are cooking seems thin for its weight or if it weighs less than the recipe specifies, reduce the cooking time. Overcooking tends to toughen seafood.

FOR FISH AND SEAFOOD,

DO NOT FILL PRESSURE COOKER OVER $\frac{2}{3}$ FULL!

OPERATING THE COOKER WITHOUT COOKING LIQUID OR ALLOWING THE COOKER TO BOIL DRY WILL DAMAGE THE COOKER.

SALMON STEAKS MOUTARDE

- | | |
|--|---------------------------------------|
| 4 small salmon steaks, 1-inch thick | 1 clove garlic, minced |
| 4 tablespoons Dijon-style mustard | 1 cup dry white wine or chicken broth |
| 3-4 sprigs fresh thyme or $\frac{1}{2}$ teaspoon dried thyme | 1 bay leaf |
| 1 tablespoon olive or vegetable oil | ••••• |
| 1 small onion, chopped | 2 tablespoons Dijon-style mustard |
| | 1 tablespoon cornstarch |

Spread each steak with 1 tablespoon mustard. Press 1 thyme sprig into mustard on each steak or sprinkle with dried thyme. Pour oil into cooker. Turn heat selector to medium and sauté onion and garlic until tender. Stir in wine and bay leaf. Place steaks on rack in cooker. Close cover securely. Place pressure regulator on vent pipe and **cook 2 minutes with pressure regulator rocking slowly. Cool cooker at once.** Carefully remove steaks and rack. Keep steaks warm. Discard bay leaf. Mix 2 tablespoons mustard with cornstarch. Stir into liquid in pressure cooker. Heat until sauce boils and thickens, stirring constantly. Serve sauce with salmon steaks.

Nutrition Information Per Serving
218 Calories, 9 g Fat, 20 mg Cholesterol

4 servings

VARIATION: Substitute halibut for salmon steaks.

“SCAMPI-STYLE” SHRIMP

- | | |
|--|-------------------------------------|
| 1 pound medium, raw shrimp,
peeled and deveined | ¼ teaspoon salt |
| 3 tablespoons margarine | 1 cup water |
| 2 tablespoons minced green onion | •••••••• |
| 6 cloves garlic, minced | 2 tablespoons minced parsley |
| 2 teaspoons lemon juice | ¼ teaspoon grated lemon peel |

Pat shrimp dry with paper towels. Place margarine in cooker. Turn heat selector to medium and melt margarine. Sauté onion and garlic. Stir in lemon juice and salt. Cook until bubbly. Pour into metal bowl which will fit loosely in cooker. Stir in shrimp. Cover bowl firmly with aluminum foil. Pour water into cooker. Place bowl on rack in cooker. Close cover securely. Place pressure regulator on vent pipe and **cook 3 minutes with pressure regulator rocking slowly. Cool cooker at once.** Stir in parsley and lemon peel.

Nutrition Information Per Serving 4 servings
 205 Calories, 11 g Fat, 173 mg Cholesterol

SHRIMP JAMBALAYA

- | | |
|---|--|
| 1 cup long grain white rice | 2 cloves garlic, minced |
| 1½ cups water | 1 bay leaf |
| 1 cup water | 1 teaspoon basil |
| •••••••• | ½ teaspoon thyme |
| 1 can (14-15 ounces) stewed
tomatoes | ½ teaspoon chili powder |
| ½ cup chicken broth | ¼ teaspoon black pepper |
| ½ pound precooked ham, diced | ¼ teaspoon salt |
| ½ cup chopped onion | ¼ teaspoon hot sauce |
| ½ cup chopped celery | •••••••• |
| ½ cup chopped green pepper | 1 pound precooked shrimp,
peeled and deveined |

Combine rice and 1½ cups water in a metal bowl which will fit loosely in cooker. Cover bowl firmly with aluminum foil. Pour 1 cup water into cooker. Place bowl on rack in cooker. Close cover securely. Place pressure regulator on vent pipe and **cook 5 minutes with pressure regulator rocking slowly. Let pressure drop of its own accord.** Open cooker and set rice aside to steam. Remove rack and water.

Add remaining ingredients, except shrimp, to cooker; stir well. Close cover securely. Place pressure regulator on vent pipe and **cook 3 minutes with pressure regulator rocking slowly. Cool cooker at once.** Stir in shrimp; cook uncovered over medium heat until shrimp is heated through, 2 to 3 minutes. Serve over rice.

Nutrition Information Per Serving 6 servings
 252 Calories, 3 g Fat, 157 mg Cholesterol

LEMON 'N DILL COD AND BROCCOLI

- | | |
|---|---|
| 1 pound frozen cod fillets,
1-inch thick | Salt |
| Dill weed | 1 cup water |
| Lemon pepper | 2 cups broccoli, cut into bite
size pieces |

Cut fish into 4 pieces. Sprinkle with dill weed, lemon pepper, and salt. Pour water into cooker. Arrange fish and broccoli on rack in cooker. Close cover securely. Place pressure regulator on vent pipe and **cook 2 minutes with pressure regulator rocking slowly. Cool cooker at once.**

Nutrition Information Per Serving
103 Calories, 1 g Fat, 49 mg Cholesterol

4 servings

SEAFOOD GUMBO

- | | |
|--|---|
| 1 cup long grain white rice | 2 cloves garlic, minced |
| 1½ cups water | 2 bay leaves |
| 1 cup water | 2 tablespoons parsley |
| ••••• | 1 teaspoon basil |
| 2½ cups chicken broth | ½ teaspoon thyme |
| 1 pound medium, fresh shrimp,
peeled and deveined | ¼ teaspoon ground red
pepper |
| 1 pound sole fillets, cut into
2-inch pieces | ¼ teaspoon salt |
| 1 can (14-15 ounces) diced
tomatoes | ••••• |
| 1 cup chopped onion | ¼ cup cold water |
| ¾ cup chopped green pepper | 2 tablespoons cornstarch |
| | 1 package (10 ounces) frozen
sliced okra, thawed |

Combine rice and 1½ cups water in a metal bowl which will fit loosely in cooker. Cover bowl firmly with aluminum foil. Pour 1 cup water into cooker. Place bowl on rack in cooker. Close cover securely. Place pressure regulator on vent pipe and **cook 5 minutes with pressure regulator rocking slowly. Let pressure drop of its own accord.** Open cooker and set rice aside to steam. Remove rack and water.

Add broth, shrimp, sole, tomatoes, onion, green pepper, garlic, bay leaves, parsley, basil, thyme, red pepper, and salt to cooker. Close cover securely. Place pressure regulator on vent pipe and **cook 1 minute with pressure regulator rocking slowly. Cool cooker at once.** Combine water and cornstarch. Stir into hot mixture. Heat until sauce thickens, stirring constantly. Stir in okra. Heat for 3 to 4 minutes. Discard bay leaf. Serve over rice.

Nutrition Information Per Serving
224 Calories, 2 g Fat, 101 mg Cholesterol

9 servings

MARINATED TUNA

1 pound tuna steak, 1-inch thick	2 cloves garlic, minced
¼ cup lemon juice	1 teaspoon ginger
2 tablespoons olive oil	½ teaspoon black pepper
1 tablespoon soy sauce	½ cup water

Place tuna steaks in a shallow glass dish. Combine remaining ingredients except water; pour over tuna. Marinate for 30 minutes, turning fish once. Remove tuna from marinade and place tuna on rack in cooker. Pour marinade and water into cooker. Place pressure regulator on vent pipe and **cook 2 minutes with pressure regulator rocking slowly. Cool cooker at once.**

Nutrition Information Per Serving
170 Calories, 6 g Fat, 52 mg Cholesterol

4 servings

SEAFOOD TIMETABLE

Pour 1 cup water into cooker. Position rack in cooker. Place seafood on rack in cooker. Do not fill cooker over ¾ full. Close cover securely. Place pressure regulator on vent pipe and **cook according to chart. Cool cooker at once.**

SEAFOOD (FRESH OR THAWED)	COOKING TIME
Crab Legs	0 to 1 minute
Fish Fillets (1-inch thick)	2 minutes
Salmon Fillets (1-inch thick)	2 minutes
Scallops Large	1 minute
Shrimp Medium to Large (36 to 40 count) Large (21 to 25 count)	0 to 1 minute 1 minute
Tuna Fillets (1-inch thick)	2 minutes

POULTRY

A host of great, light meals can evolve from chicken and other poultry when prepared in the pressure cooker. Be it a tender fillet with a delightful, light sauce or a savory casserole with a host of nutritious vegetables, you'll find the pressure cooker is perfect for preparing your favorites in a hurry.

Try the following recipes and enjoy tasty poultry in a variety of ways or prepare your own favorite poultry dishes. It's not necessary to brown poultry before pressure cooking, but you may do so if you like. Searing tends to seal in the natural juices, while cooking without browning lets the flavor of the various ingredients intermingle for some spectacular taste combinations. For crispier chicken, you may want to put the chicken under the broiler for a few minutes after pressure cooking.

**FOR POULTRY, DO NOT FILL PRESSURE COOKER OVER $\frac{2}{3}$ FULL!
NO PORTION OF THE POULTRY SHOULD EXTEND ABOVE
THE $\frac{2}{3}$ FULL MARK (SEE PAGE 12).**

**OPERATING THE COOKER WITHOUT COOKING LIQUID OR
ALLOWING THE COOKER TO BOIL DRY WILL DAMAGE THE COOKER.**

CHICKEN BREASTS TARRAGON

1 tablespoon vegetable oil	$\frac{1}{4}$ cup sliced carrot
4 boneless, skinless chicken breast halves	1 teaspoon tarragon
$\frac{1}{2}$ cup white wine	1 teaspoon salt
Worcestershire sauce	$\frac{1}{4}$ teaspoon black pepper
$\frac{1}{2}$ cup white wine	••••••••
$\frac{1}{4}$ cup chopped onion	$\frac{1}{4}$ cup cold water
$\frac{1}{4}$ cup sliced celery	1 tablespoon cornstarch

Pour oil into cooker. Turn heat selector to medium and brown chicken. Add remaining ingredients except water and cornstarch. Close cover securely. Place pressure regulator on vent pipe and **cook 4 minutes with pressure regulator rocking slowly. Cool cooker at once.** Remove chicken and keep warm. Combine water and cornstarch. Stir into sauce. Heat until sauce thickens, stirring constantly.

Nutrition Information Per Serving
219 Calories, 5 g Fat, 69 mg Cholesterol

4 servings

CALIFORNIA CHICKEN

2	tablespoons vegetable oil	½	cup white wine
6	boneless, skinless chicken breast halves	½	cup chicken broth
		¼	cup chopped parsley
1	teaspoon rosemary	••••••	
3	cloves garlic, peeled and sliced	½	lemon, thinly sliced
			Salt and pepper to taste

Pour oil into cooker. Turn heat selector to medium and brown chicken. Season chicken with rosemary. Cover chicken with garlic. Combine wine, broth, and parsley; pour over chicken. Close cover securely. Place pressure regulator on vent pipe and **cook 4 minutes with pressure regulator rocking slowly. Cool cooker at once.** Garnish chicken with lemon slices.

Nutrition Information Per Serving *6 servings*
191 Calories, 6 g Fat, 69 mg Cholesterol

CHUTNEY CHICKEN

6	boneless, skinless chicken breast halves	⅓	cup mango chutney
		1	tablespoon vinegar
1	can (14-15 ounces) diced tomatoes	1	tablespoon brown sugar
		¼	teaspoon allspice
1	can (4 ounces) chopped green chilies	••••••	
½	cup raisins	¼	cup water
		1	tablespoon cornstarch

Place all ingredients except cornstarch and water in cooker. Close cover securely. Place pressure regulator on vent pipe and **cook 4 minutes with pressure regulator rocking slowly. Let pressure drop of its own accord.** Remove chicken and keep warm. Combine water and cornstarch. Stir into sauce. Heat until sauce thickens, stirring constantly.

Nutrition Information Per Serving *6 servings*
258 Calories, 3 g Fat, 73 mg Cholesterol

SOY CHICKEN

4	boneless, skinless chicken breast halves	½	cup sliced mushrooms
		½	onion, sliced
½	cup water	½	cup sliced celery
¼	cup lite soy sauce	3	tablespoons brown sugar

Place all ingredients in cooker. Close cover securely. Place pressure regulator on vent pipe and **cook 4 minutes with pressure regulator rocking slowly. Let pressure drop of its own accord.**

Nutrition Information Per Serving *4 servings*
169 Calories, 2 g Fat, 69 mg Cholesterol

SWEET 'N SOUR CHICKEN

- | | | | |
|---|--|--------|-------------------------------|
| 1 | tablespoon vegetable oil | ½ | cup vinegar |
| 3 | pound chicken, cut into serving pieces and skinned | 2 | tablespoons soy sauce |
| 1 | can (8 ounces) pineapple chunks, undrained | 1 | tablespoon catsup |
| ½ | cup sliced celery | ½ | teaspoon Worcestershire sauce |
| 1 | green or red pepper, cut into chunks | ¼ | teaspoon ground ginger |
| ¼ | cup brown sugar | •••••• | |
| | | 2 | tablespoons cold water |
| | | 2 | tablespoons cornstarch |

Pour oil into cooker. Turn heat selector to medium and brown chicken. Combine remaining ingredients except water and cornstarch; pour over chicken. Close cover securely. Place pressure regulator on vent pipe and **cook 8 minutes with pressure regulator rocking slowly. Cool cooker at once.** Remove chicken, pineapple, and vegetables to a warm platter. Mix water and cornstarch. Stir into hot liquid. Heat until sauce thickens, stirring constantly. Pour sauce over chicken, pineapple, and vegetables. Serve with steamed rice, if desired, see page 57.

Nutrition Information Per Serving *6 servings*
 333 Calories, 11 g Fat, 104 mg Cholesterol

CHICKEN CACCIATORE

- | | | | |
|----|--|--------|-----------------------------|
| 3 | pound chicken, cut into serving pieces | 2 | cloves garlic, minced |
| 1 | cup diced tomatoes | 2 | tablespoons minced parsley |
| ⅓ | cup white wine | 1 | teaspoon oregano |
| 1½ | cups sliced onions | 1 | teaspoon salt |
| ½ | cup chopped carrots | ¼ | teaspoon black pepper |
| ½ | cup chopped celery | •••••• | |
| | | 1 | can (6 ounces) tomato paste |

Place all ingredients except tomato paste in pressure cooker. Close cover securely. Place pressure regulator on vent pipe and **cook 8 minutes with pressure regulator rocking slowly. Cool cooker at once.** Place chicken on warm platter. Stir tomato paste into sauce in cooker. Simmer until thickened. Pour over chicken.

Nutrition Information Per Serving *6 servings*
 291 Calories, 14 g Fat, 90 mg Cholesterol

HERBED CHICKEN

- | | | | |
|---|-----------------------------------|--------|---------------------------------------|
| 1 | tablespoon vegetable oil | 1 | teaspoon oregano |
| 1 | cup chopped onion | 1 | teaspoon basil |
| 1 | tablespoon chopped garlic | •••••• | |
| 3 | pounds chicken thighs,
skinned | 1 | can (4 ounces) sliced black
olives |
| 1 | cup chicken broth | 2 | tablespoons cold water |
| 1 | tablespoon chopped parsley | 2 | tablespoons flour |
| ½ | cup chopped celery leaves | | Salt and pepper to taste |

Pour oil into cooker. Turn heat selector to medium and sauté onion and garlic; remove. Brown chicken. Add onion, garlic, broth, parsley, celery leaves, oregano, and basil. Close cover securely. Place pressure regulator on vent pipe and **cook 8 minutes with pressure regulator rocking slowly. Cool cooker at once.** Remove chicken to a warm dish. Add olives to liquid and heat. Mix water with flour. Stir into hot broth. Heat until sauce thickens, stirring constantly. Pour sauce over chicken.

Nutrition Information Per Serving *6 servings*
250 Calories, 8 g Fat, 115 mg Cholesterol

BAYOU BOUNTY CHICKEN

- | | | | |
|----|--|--------|---|
| 1½ | pounds chicken pieces | 2 | cloves garlic, minced |
| 1 | can (15 ounces) whole
tomatoes, undrained, cut up | ½ | tablespoon extra-spicy
seasoning blend |
| ¾ | cup chopped onion | •••••• | |
| ½ | cup chopped green pepper | | Hot cooked rice |
| ½ | cup chopped celery | | (see page 57) |

Add all ingredients except rice to pressure cooker. Close cover securely. Place pressure regulator on vent pipe and **cook 8 minutes with pressure regulator rocking slowly. Let pressure drop of its own accord.** Serve chicken and sauce over rice.

Nutrition Information Per Serving *3 servings*
394 Calories, 14 g Fat, 90 mg Cholesterol

TURKEY BREAST*

***NOTE: USE THIS RECIPE ONLY IN A 6-QUART OR 8-QUART PRESSURE COOKER**

1 tablespoon vegetable oil	½ cup chopped celery
3-4 pound turkey breast	½ teaspoon poultry seasoning
1½ cups water	Salt and pepper to taste
1 onion, chopped	

Pour oil into cooker. Turn heat selector to medium and brown turkey on all sides. Add remaining ingredients. Close cover securely. Place pressure regulator on vent pipe and **cook 35 minutes with pressure regulator rocking slowly. Let pressure drop of its own accord.** Thicken gravy, if desired.

Nutrition Information Per Serving
197 Calories, 8 g Fat, 76 mg Cholesterol

6 to 8 servings

CHICKEN AND DRESSING

2½ cups cooked chicken, cut into bite size pieces	¼ cup chopped celery
1 can (10 ½ ounces) cream of chicken soup	¼ cup chopped onion
1½ cups seasoned bread crumbs	2 chicken bouillon cubes
	2 cups hot water
	1½ cups water

Place chicken in greased metal bowl which will fit loosely in the cooker. Cover chicken with chicken soup. Combine stuffing, celery, onion; moisten with bouillon cubes dissolved in water. Spread over chicken soup. Cover bowl firmly with aluminum foil. Pour 1½ cups water into cooker. Place bowl on rack in cooker. Close cover securely. Place pressure regulator on vent pipe and **cook 5 minutes with pressure regulator rocking slowly. Let pressure drop of its own accord.**

Nutrition Information Per Serving
317 Calories, 13 g Fat, 109 mg Cholesterol

6 servings

POULTRY TIMETABLE

It is not necessary to brown poultry before pressure cooking, but you may do so if you like. After browning, remove poultry from cooker and pour liquid into cooker. Place poultry on rack in cooker

DO NOT FILL PRESSURE COOKER OVER $\frac{2}{3}$ FULL!

NO PORTION OF THE POULTRY SHOULD EXTEND ABOVE THE $\frac{2}{3}$ FULL MARK (SEE PAGE 12).

POULTRY	CUPS OF LIQUID	COOKING TIME (MINUTES)
Whole Chicken (2½ to 3 pounds)	1	13 to 15
Chicken (cut into serving pieces)	1	8
Chicken Breast (boneless)	1	3 to 4*
Turkey Breast** (3 to 4 pounds)	1½	35

*Cool cooker at once (see page 10).

****NOTE: COOK ONLY IN A 6-QUART OR 8-QUART PRESSURE COOKER.**

MEATS

When it comes to creating juicy, tender, flavorful meat dishes, the pressure cooker has no equal. Even budget cuts of meat that usually require slow, moist-heat cooking will turn out succulent and savory—in very little time in the pressure cooker.

An important step when preparing meat in the pressure cooker is to sear meat to a crispy brown on all sides to seal in natural juices. This can be done right in the pressure cooker. The following recipes were written for fresh or completely thawed meats. To cook frozen meats, thaw one half hour or more so that the surface of the meat will sear crispy brown. Then increase the cooking times given in the recipes. Frozen beef, veal, and lamb should be cooked 25 minutes per pound. Frozen pork should be cooked 30 minutes per pound.

Cooking time will vary depending on the size and thickness of the cut, the distribution of fat and bone, the grade and cut of the meat, and the degree of doneness desired.

After cooking if gravy is desired, stir 1 to 2 tablespoons of flour or cornstarch into $\frac{1}{4}$ cup cold water. Heat cooking liquid in pressure cooker and slowly pour in flour mixture, stirring to blend. Heat to boiling, stirring constantly for 1 minute or until thickened. Season with salt and pepper.

**FOR MEAT, DO NOT FILL PRESSURE COOKER
OVER $\frac{2}{3}$ FULL! NO PORTION OF THE MEAT SHOULD
EXTEND ABOVE THE $\frac{2}{3}$ FULL MARK (SEE PAGE 12).**

**OPERATING THE COOKER WITHOUT COOKING LIQUID OR
ALLOWING THE COOKER TO BOIL DRY WILL DAMAGE THE COOKER.**

BEEF POT ROAST

- | | |
|-----------------------------------|-------------------------------|
| 3 pounds beef pot roast | Salt and pepper |
| 1 tablespoon vegetable oil | 1 small onion, chopped |
| 2 cups water | 1 bay leaf |

Pour oil into cooker. Turn heat selector to medium and brown roast well on all sides; remove roast. Pour water into cooker. Place roast on rack in cooker. Season roast with salt, pepper, onions, and bay leaf. Close cover securely. Place pressure regulator on vent pipe and **cook 45 minutes with pressure regulator rocking slowly. Let pressure drop of its own accord.** Thicken gravy, if desired.

Nutrition Information Per Serving
297 Calories, 20 g Fat, 72 mg Cholesterol

6 servings

PORCUPINE MEATBALLS

- | | |
|---|-----------------------------------|
| 1 pound lean ground beef | ¼ cup sliced celery |
| ⅓ cup uncooked long-grain white rice | ¼ cup chopped green pepper |
| 2 tablespoons tomato paste | 1 cup tomato sauce |
| 1 teaspoon salt | ½ cup water |
| ¼ teaspoon pepper | 1 tablespoon sugar |
| ½ cup chopped onion | ½ teaspoon dry mustard |

Combine ground beef, rice, tomato paste, salt, and pepper; mix well. Form into 8 balls. Place meatballs in cooker. Add onion, celery, and green pepper. Combine tomato sauce, water, sugar, and mustard. Pour over meatballs. Close cover securely. Place pressure regulator on vent pipe and **cook 12 minutes with pressure regulator rocking slowly. Cool cooker at once.**

Nutrition Information Per Serving
350 Calories, 17 g Fat, 77 mg Cholesterol

4 servings

SWISS STEAK

- | | |
|---|-----------------------------------|
| 2 pounds round steak, 1-inch thick | 1 cup chopped onion |
| 1 can (8 ounces) tomato sauce | ½ cup chopped green pepper |
| ½ cup water | ½ cup sliced celery |
| | ½ teaspoon salt |
| | ¼ teaspoon pepper |

Place all ingredients in cooker. Close cover securely. Place pressure regulator on vent pipe and **cook 18 minutes with pressure regulator rocking slowly. Cool cooker at once.** Thicken sauce, if desired.

Nutrition Information Per Serving
251 Calories, 9 g Fat, 98 mg Cholesterol

6 servings

BEEF STEW

- | | |
|--|----------------------------------|
| 1 pound lean beef, cut into 1-inch cubes | 1 cup sliced carrots |
| 1 cup water | 1 cup diced tomatoes |
| 1 large onion, sliced
..... | 1 teaspoon salt |
| 4 small potatoes, quartered | ¼ teaspoon black pepper
..... |
| 1 cup frozen green beans | ¼ cup cold water |
| | 1 tablespoon flour |

Place beef, water, and onion in cooker. Close cover securely. Place pressure regulator on vent pipe and **cook 8 minutes with pressure regulator rocking slowly. Cool cooker at once.**

Add potatoes, green beans, carrots, tomatoes, salt, and pepper to cooker. Close cover securely. Place pressure regulator on vent pipe and **cook 3 minutes with pressure regulator rocking slowly. Cool cooker at once.**

Mix water and flour; stir into stew. Heat until stew thickens, stirring constantly.

Nutrition Information Per Serving
347 Calories, 7 g Fat, 73 mg Cholesterol

4 servings

SPAGHETTI MEAT SAUCE

- | | |
|--|-----------------------------------|
| 1 pound lean ground beef | 1 teaspoon parsley flakes |
| 1 can (14 to 15 ounces) diced tomatoes | ½ teaspoon oregano |
| ½ cup water | ½ teaspoon basil |
| 1 cup chopped onion | ¼ teaspoon thyme |
| ½ cup chopped celery | ⅛ teaspoon red pepper |
| ½ cup diced green pepper | 3 drops hot pepper sauce
..... |
| 1 clove garlic, minced | 1 can (6 ounces) tomato paste |
| 2 teaspoons sugar | |
| 1 teaspoon salt | |

Turn heat selector to medium and brown beef. Stir in remaining ingredients except tomato paste. Close cover securely. Place pressure regulator on vent pipe and **cook 8 minutes with pressure regulator rocking slowly. Cool cooker at once.** Stir in tomato paste and simmer, uncovered, to desired thickness. Serve sauce over spaghetti. Sprinkle with Parmesan cheese, if desired.

Nutrition Information Per Serving
229 Calories, 12 g Fat, 51 mg Cholesterol

6 servings

APRICOT BARBECUE PORK ROAST

- | | |
|---|--------------------------------------|
| 3 pound boneless rolled pork roast | 1 teaspoon crushed red pepper |
| ½ cup catsup | 1 teaspoon dry mustard |
| ½ cup teriyaki sauce | ¼ teaspoon black pepper |
| ⅓ cup apricot preserves | 1 large onion, sliced |
| ¼ cup cider vinegar | 2 cups water |
| ¼ cup packed dark brown sugar | |

Place pork roast in a large plastic bag or glass dish. Combine catsup, teriyaki sauce, preserves, vinegar, brown sugar, red pepper, mustard, and pepper. Mix thoroughly and pour over pork. Refrigerate overnight. Remove pork; reserve marinade. Brown pork on all sides in pressure cooker over medium heat; remove.

Place cooking rack, half of sliced onion, and water in cooker. Place pork roast on rack in cooker and arrange remaining onion evenly on top of roast. Close cover securely. Place pressure regulator on vent pipe and **cook 60 minutes with pressure regulator rocking slowly. Let pressure drop of its own accord.** Place reserved marinade in saucepan and simmer until thickened, stirring occasionally. Remove roast and onions from pressure cooker. Add onions to thickened marinade and serve with sliced pork. Onions may be puréed before adding to sauce and served with rice, if desired.

Nutrition Information Per Serving *8 servings*
332 Calories, 13 g Fat, 77 mg Cholesterol

BARBECUE SPARERIBS

- | | |
|--|--------------------------------|
| 3 pounds spareribs, cut into serving pieces | ½ cup vinegar |
| 1 cup water | ¼ cup chopped onion |
| ••••• | ¼ cup sugar |
| 1 cup catsup | 1 teaspoon salt |
| ½ cup water | 1 teaspoon chili powder |
| | 1 teaspoon celery seed |

Place ribs and water in cooker. Close cover securely. Place pressure regulator on vent pipe and **cook 5 minutes with pressure regulator rocking slowly. Cool cooker at once.** Drain off liquid. Mix remaining ingredients; pour over ribs in cooker. Stir to coat ribs. Close cover securely. Place pressure regulator on vent pipe and **cook 10 minutes with pressure regulator rocking slowly. Let pressure drop of its own accord.** Remove ribs. Simmer sauce, uncovered, to desired thickness.

Nutrition Information Per Serving *6 servings*
427 Calories, 27 g Fat, 107 mg Cholesterol

CORNED BEEF

- | | |
|-----------------------------|-----------------------------------|
| 3 pounds corned beef | 1 tablespoon garlic powder |
| 2 cups water | 1 bay leaf |

Pour water into cooker. Rub garlic powder into all surfaces of corned beef. Place corned beef on rack in cooker. Add bay leaf. Close cover securely. Place pressure regulator on vent pipe and **cook 60 minutes with pressure regulator rocking slowly. Let pressure drop of its own accord.**

Note: If seasoning packet is provided with corn beef, use packet and omit bay leaf.

Nutrition Information Per Serving *6 servings*
295 Calories, 18 g Fat, 103 mg Cholesterol

STUFFED PORK CHOPS

- | | |
|---|-----------------------------------|
| 2 tablespoons vegetable oil | ½ cup corn |
| 4 1-inch thick boneless pork chops, with deep pocket cut in each | 1 cup bran flakes, crushed |
| 1 cup chopped onion | 2 tablespoons water |
| ¾ cup chopped celery | ½ teaspoon dried sage |
| | 1½ cups water |
| | Salt and pepper to taste |

Pour oil into cooker. Turn heat selector to medium and brown pork chops. Remove from cooker. Sauté onions and celery in cooker. Stir in corn, bran flakes, 2 tablespoons water, and sage; remove from cooker. Stuff pork chops with mixture. Pour 1½ cups water into cooker. Place pork chops on rack in cooker. Close cover securely. Place pressure regulator on vent pipe and **cook 16 minutes with pressure regulator rocking slowly. Cool cooker at once.**

Nutrition Information Per Serving *4 servings*
430 Calories, 20 g Fat, 133 mg Cholesterol

PORK ROAST

- | | |
|-----------------------------------|------------------------|
| 3 pound pork roast | Salt and pepper |
| 1 tablespoon vegetable oil | 1 onion, sliced |
| 2 cups water | |

Pour vegetable oil into cooker. Turn heat selector to medium and brown roast well on all sides. Remove roast from cooker. Pour water into cooker. Place roast on rack in cooker. Season with salt, pepper, and sliced onion. Close cover securely. Place pressure regulator on vent pipe and **cook 55 minutes with pressure regulator rocking slowly. Let pressure drop of its own accord.**

Nutrition Information Per Serving *6 servings*
483 Calories, 27 g Fat, 171 mg Cholesterol

STUFFED FLANK STEAK

- | | | | |
|---|------------------------------------|---|---|
| 1 | tablespoon margarine | ½ | teaspoon salt |
| ½ | cup chopped onion | ¼ | teaspoon marjoram |
| ½ | cup chopped celery | ¼ | teaspoon thyme |
| 1 | clove garlic, minced | ⅛ | teaspoon black pepper |
| 6 | tablespoons beef broth,
divided | 1 | pound flank steak, cut
into 2 equal pieces |
| 1 | cup bread crumbs | 1 | cup diced tomatoes |

Add margarine to cooker. Turn heat selector to medium and sauté onion, celery, and garlic. Mix in 2 tablespoons of the broth, bread crumbs, salt, marjoram, thyme, and pepper. Spread stuffing mixture on one steak; top with remaining steak. Secure with toothpicks or metal skewers. Place steak in cooker; stir in remaining 4 tablespoons broth and tomatoes. Close cover securely. Place pressure regulator on vent pipe and **cook 18 minutes with pressure regulator rocking slowly. Let pressure drop of its own accord.**

Nutrition Information Per Serving
237 Calories, 12 g Fat, 47 mg Cholesterol

4 servings

LAMB STEW

- | | | | |
|---|--|---|--------------------------------|
| 1 | pound lamb stew meat, cut
into 1-inch cubes | 4 | small potatoes, quartered |
| 1 | cup water | 1 | cup baby-cut carrots |
| 1 | large onion, sliced | 1 | teaspoon salt |
| 1 | tablespoon Worcestershire
sauce | ¼ | teaspoon black pepper
..... |
| 1 | large clove garlic, minced
..... | ¼ | cup cold water |
| | | 1 | tablespoon flour |

Place lamb, water, onion, Worcestershire sauce, and garlic in cooker. Close cover securely. Place pressure regulator on vent pipe and **cook 6 minutes with pressure regulator rocking slowly. Cool cooker at once.**

Add potatoes, carrots, salt, and pepper. Close cover securely. Place pressure regulator on vent pipe and **cook 3 minutes with pressure regulator rocking slowly. Cool cooker at once.**

Mix water and flour thoroughly; stir into stew. Heat until stew thickens, stirring constantly.

Nutrition Information Per Serving
315 Calories, 6 g Fat, 74 mg Cholesterol

4 servings

MEAT TIMETABLE

Brown meat well and remove from cooker. Pour liquid into cooker. Place meat on rack in cooker.

DO NOT FILL PRESSURE COOKER OVER $\frac{2}{3}$ FULL!

NO PORTION OF THE MEAT SHOULD EXTEND ABOVE THE $\frac{2}{3}$ FULL MARK (SEE PAGE 12).

MEAT		CUPS OF LIQUID	COOKING TIME (MINUTES)
BEEF			
Chuck Roast	3 pounds	2	45 – 50
Corned Beef	3 pounds	2	60
Rolled Rib Roast	3 pounds	1½	30 – 35
Round Steak	1" thick	1	18*
Round Steak	½" thick	1	10*
Short Ribs		1½	25
HAM			
Slice	3 pounds	1½	30 – 35
Picnic	3 pounds	1½	30 – 35
LAMB			
Chops	1" thick	1	12*
Chops	½" thick	1	5*
Leg of Lamb	3 pounds	2	35-45
PORK			
Chops	1" thick	1	15*
Chops	½" thick	1	8*
Butt Roast	3 pounds	2	55
Fresh Picnic Roast	3 pounds	2	55
Steak	1" thick	1	12*
Steak	½" thick	1	5*
VEAL			
Chops	1" thick	1	12*
Chops	½" thick	1	5*
Roast	3 pounds	2	45 – 50
Steak	1" thick	1	10*

*Cool cooker at once (see page 10).

VEGETABLES

Vegetables have assumed new importance and prominence on the menu. Health-conscious cooks feature an abundance of vegetables on the family meal plan, while restaurants increasingly cater to a more “vegetable-conscious” clientele.

Pressure cooking is the preferred method for preparing vegetables. Because of the fast cooking time and super-heated steam, vegetables retain most of their natural color, texture, flavor, and nutrients. And pressure cooking offers an additional health advantage, because so much more natural taste is retained, vegetables require much less salt and seasonings.

A garden variety of fresh or frozen vegetables can be cooked at the same time in the pressure cooker. By using the cooking rack to keep them out of the cooking liquid, each vegetable retains its own distinctive flavor and appearance. Just be sure that all vegetables cooked together require the same cooking time. It is important to accurately time the cooking period, because vegetables cook very quickly in the pressure cooker. If you wish to blend the vegetable flavors, place them in the cooking liquid and omit the rack.

**FOR FRESH AND FROZEN VEGETABLES,
DO NOT FILL PRESSURE COOKER OVER $\frac{2}{3}$ FULL!**

**OPERATING THE COOKER WITHOUT COOKING LIQUID OR
ALLOWING THE COOKER TO BOIL DRY WILL DAMAGE THE COOKER.**

CABBAGE WITH APPLES

- | | |
|---|-----------------------------------|
| 8 cups shredded cabbage | ½ cup chicken broth |
| 1 small onion, thinly sliced | 2 tablespoons frozen apple |
| 1 small tart apple, peeled, cored, and chopped | juice concentrate, thawed |
| | Salt and pepper to taste |

Add all ingredients to cooker. Close cover securely. Place pressure regulator on vent pipe and **cook 4 minutes with pressure regulator rocking slowly**. **Cool cooker at once**.

Nutrition Information Per Serving
50 Calories, 0 g Fat, 0 mg Cholesterol

6 servings

GLAZED ROOT VEGETABLES

- | | |
|---|--|
| 2 tablespoons margarine | 2 tablespoons sugar |
| 2 medium turnips, peeled, cut into eighths | 2 teaspoons ground ginger |
| 8 ounces baby carrots | •••••••• |
| 2 medium parsnips, peeled, sliced ½-inch thick | ¼ cup cold water, optional |
| 1 cup chicken broth | 1 tablespoon cornstarch, optional |
| | Salt and pepper to taste |

Heat margarine in pressure cooker over medium heat; add turnip wedges and carrots and sauté for 3 minutes. Add parsnips, chicken broth, ginger, and sugar. Close cover securely. Place pressure regulator on vent pipe and **cook 1 minute with pressure regulator rocking slowly**. **Cool cooker at once**. Combine water and cornstarch. Stir into sauce. Heat until sauce thickens, stirring constantly.

Nutrition Information Per Serving
77 Calories, 3 g Fat, 0 mg Cholesterol

8 servings

GARLIC MASHED POTATOES

- | | |
|---|---------------------------------|
| 2 pounds russet potatoes, peeled and diced | ••••••• |
| 4 large cloves garlic | 1 tablespoon margarine |
| 1½ cups chicken broth | Salt and pepper to taste |

Place all ingredients except margarine and salt and pepper in cooker. Close cover securely. Place pressure regulator on vent pipe and **cook 5 minutes with pressure regulator rocking slowly**. **Cool cooker at once**. Allow potatoes, garlic, and broth to remain in cooker. Mash potatoes using a potato masher or hand mixer until desired consistency is reached. Add margarine.

Nutrition Information Per Serving
127 Calories, 4 g Fat, 0 mg Cholesterol

6 servings

ARTICHOKES 'N SAUCE

- | | |
|-----------------------------------|---------------------|
| 1 cup water | 3 artichokes |
| 1 tablespoon vegetable oil | |

Pour water and oil into cooker. Place artichokes on rack in cooker. Close cover securely. Place pressure regulator on vent pipe and **cook 10 minutes with pressure regulator rocking slowly**. **Cool cooker at once**. Serve with your choice of the following sauces.

Nutrition Information Per Serving
60 Calories, 0 g Fat, 0 mg Cholesterol

3 servings

GARLIC SAUCE — Combine ¼ cup margarine, melted and 2 cloves minced garlic. Serve warm.

HERB YOGURT — Combine 1 cup plain yogurt, ¼ cup finely chopped carrots, ½ teaspoon dill weed, and ¼ teaspoon salt. Serve chilled.

ITALIAN SAUCE — Combine ½ cup mayonnaise and ¼ cup Italian style salad dressing. Serve chilled.

MAPLE GLAZED SWEET POTATOES

3 sweet potatoes, peeled, cut into 1 to 1½ -inch chunks	1 tablespoon melted margarine
¾ cup maple flavored syrup	½ teaspoon salt
½ cup water	

Place sweet potatoes in pressure cooker. Combine remaining ingredients and pour over potatoes. Close cover securely. Place pressure regulator on vent pipe and **cook 5 minutes with pressure regulator rocking slowly. Cool cooker at once.**

Nutrition Information Per Serving

125 Calories, 2 g Fat, 0 mg Cholesterol

6 servings

FRESH AND FROZEN VEGETABLE TIMETABLE

When using the vegetable timetables on pages 50-52, cook the vegetables the minimum amount of time indicated if you prefer your vegetables crisp. If you prefer your vegetables soft, cook them the maximum amount of time indicated.

TO PREVENT OVER-COOKING, COOL COOKER AT ONCE AFTER COOKING VEGETABLES, EXCEPT WHEN NOTED.

If the timetable says to cook 0 minutes, this means to cook food until the pressure regulator begins to rock, then cool cooker at once.

Quantity of vegetables does not change pressure cooking times. More mature vegetables may require longer pressure cooking times than given in chart.

For fresh and frozen vegetables, pour liquid into cooker. Place vegetables on rack in cooker.

**FOR FRESH AND FROZEN VEGETABLES,
DO NOT FILL PRESSURE COOKER OVER $\frac{2}{3}$ FULL!**

FRESH VEGETABLE TIMETABLE

VEGETABLE	SIZE	CUPS OF LIQUID	COOKING TIME (MINUTES)
Artichoke	Whole, 6 to 8 ounces	1	10
Asparagus	Stems cut into 1-inch pieces	1	0 – 1
Beans (green, wax)	Whole or sliced	1	1 – 3
Beets	Whole, 2½-inch diameter	1½	15 – 16
Broccoli	Flowerets	1	0 – 2
Brussels Sprouts	Small, 1-inch diameter	1	1 – 3
Cabbage (red, green)	Wedges, 2-inch thick	1	3 – 5
	Thinly sliced	1	2 – 3
Carrots	Baby cut	1	3 – 5
	½-inch slices	1	3 – 5
Cauliflower	Flowerets	1	0 – 2
Collards*	Leaves coarsely chopped, stems thinly sliced	1	3 – 4
Corn on-the-cob	Whole, 2½-inch diameter	1	3
Eggplant	Cubed, 1 to 1½-inches thick	1	2 – 3
	Sliced, ½-inch thick	1	2
Kale	Leaves coarsely chopped, stems thinly sliced	1	1 – 2
Parsnips	Sliced, ½-inch thick	1	0 – 2

* Do not use rack; place in cooking liquid.

FRESH VEGETABLE TIMETABLE

VEGETABLE	SIZE	CUPS OF LIQUID	COOKING TIME (MINUTES)
Peas	Shelled	1	0 – 2
Peppers	Whole	1	0 – 3
Potatoes (sweet)	Sliced, 1 to 1½-inches thick	1	6 – 8
	Sliced, ½-inch thick	1	4 – 5
Potatoes (white)	Whole, 2½-inch diameter	1½	15
	Whole, 1½-inch diameter	1	10
	Sliced, ¾-inch thick	1	5
	Sliced, ½-inch thick	1	3
Rutabaga	Cubed or sliced, 1-inch thick	1	3
Spinach	Whole leaves	1	0
Squash (winter) acorn+	Quartered	1	12
Squash (winter) spaghetti+	Halved	1	12
Squash (yellow, zucchini)	Sliced, 1-inch thick	1	1
	Sliced, ¼ to ½-inch thick	1	0 – 1
Swiss Chard	Whole leaves	1	0 – 1
Turnips	Sliced or cubed, ¾-inch thick	1	3 – 5

+ Let pressure drop of its own accord.

FROZEN VEGETABLE TIMETABLE

VEGETABLE	CUPS OF LIQUID	COOKING TIME (MINUTES)
Asparagus (cut, spears)	1	2
Beans (green, wax, french style)	1	1 – 2
Broccoli	1	1 – 2
Brussels Sprouts	1	2 – 3
Cauliflower	1	1 – 2
Corn Cut	1	1 – 2
Corn on Cob	1	2 – 3
Lima Beans	1	1 – 2
Mixed Vegetables	1	1 – 2
Peas	1	1 – 2
Peas and Carrots	1	1 – 2
Spinach	1	2 – 4

DRY BEANS AND PEAS

The pressure cooker is ideal for preparing dry beans and peas quickly. However, dry beans and peas have a tendency to froth and foam during cooking, which could cause the vent pipe to become blocked. **Therefore, it is necessary to use the following cautions when pressure cooking dry beans and peas:**

- (1) **Never fill the cooker over the ½ full line (this includes beans, ingredients, and water).**
- (2) **Add 1 tablespoon vegetable oil for cooking.**
- (3) **Allow pressure to drop of its own accord.**

SOAKING BEANS AND PEAS — Soaking is strongly recommended for all beans and peas, except lentils and black-eyed peas, for even cooking and to remove water-soluble, gas-producing starches. Soaking can be done using the traditional or the quick-soak method.

Traditional method: Clean and rinse beans; cover with three times as much water as beans. Soak 4 to 8 hours. Drain.

Quick method: Clean and rinse beans; cover with three times as much water as beans. Bring beans to a boil and boil for 2 minutes. Remove from heat, cover, and let stand for 1 to 2 hours. Drain.

COOKING BEANS AND PEAS — After soaking, rinse beans and remove any loose skins. Place beans in pressure cooker. Add fresh water to just cover the beans and add 1 tablespoon vegetable oil. Close cover securely. Place pressure regulator on vent pipe and cook according to the times in the timetable on page 54. For more firm beans for salads and side dishes and when cooking less than 2 cups of beans or peas, use the shorter time. For soups and stews, use the longer time. **After cooking is complete, allow pressure to drop of its own accord.**

FOR DRY BEANS AND PEAS,

DO NOT FILL PRESSURE COOKER OVER ½ FULL!

OPERATING THE COOKER WITHOUT COOKING LIQUID OR
ALLOWING THE COOKER TO BOIL DRY WILL DAMAGE THE COOKER.

DRY BEANS AND PEAS TIMETABLE

Soak beans and peas, except lentils and black-eyed peas, according to information on page 53. **Add 1 tablespoon vegetable oil to cooking liquid. DO NOT COOK SPLIT PEAS.**

FOR DRY BEANS AND PEAS, DO NOT FILL PRESSURE COOKER OVER ½ FULL!

BEANS AND PEAS	COOKING TIME (MINUTES)
Adzuki	1 – 3
Anasazi	1 – 3
Black beans	2 – 4
Black-eyed peas	2 – 4*
+ Chickpeas (garbanzo)	7 – 10
Great Northern beans	2 – 5
Kidney beans	1 – 3
Lentils (brown, green)	3 – 5*
+ Lima beans (large)	0 – 1
+ Lima beans (baby)	1 – 3
Navy beans (pea)	1 – 3
Peas (whole yellow, green)	6 – 9
Pinto beans	3 – 6
Red beans	3 – 6
Soy beans (beige)	8 – 11

* **cooking time is for unsoaked beans**

+ add ½ to 1 teaspoon salt to soaking and cooking water to keep bean skins intact.

LENTIL CURRY

1 tablespoon vegetable oil	½ tablespoon curry powder
¾ cup chopped onion	½ teaspoon ground ginger
3 cups water	••••••••
1 cup lentils	½ teaspoon salt
½ tablespoon coriander	

Pour oil into cooker. Turn heat selector to medium and sauté onions. Add water, lentils, coriander, curry powder, and ginger. Close cover securely. Place pressure regulator on vent pipe and **cook 3 minutes with pressure regulator rocking slowly. Let pressure drop of its own accord.** Stir in salt.

Nutrition Information Per Serving
190 Calories, 2 g Fat, 0 mg Cholesterol

4 servings

BAKED BEANS

- | | |
|--|----------------------------------|
| 2 cups navy beans | 1 medium onion, minced |
| 3 cups water | 1/3 cup brown sugar |
| 1/4 cup catsup | 1/2 teaspoon dry mustard |
| 1/4 cup molasses | 1/4 teaspoon black pepper |
| 1 8-ounce slice uncooked ham, diced | |
| | Salt to taste |

Soak beans according to instructions on page 53. Add drained navy beans and remaining ingredients except salt to cooker. Close cover securely. Place pressure regulator on vent pipe and **cook 35 minutes with pressure regulator rocking slowly. Let pressure drop of its own accord.**

Nutrition Information Per Serving *6 servings*
264 Calories, 4 g Fat, 5 mg Cholesterol

SAVORY WHITE BEANS

- | | |
|-----------------------------------|----------------------------------|
| 2 cups navy beans | 1 small bay leaf |
| 3 cups chicken broth | 1/2 teaspoon thyme |
| 1 cup chopped onion | 1/4 teaspoon rosemary |
| 1 cup sliced carrots | 1/4 teaspoon black pepper |
| 1 tablespoon minced garlic | |
| 1 tablespoon vegetable oil | Salt to taste |

Soak beans according to instructions on page 53. Add all ingredients except salt to cooker. Close cover securely. Place pressure regulator on vent pipe and **cook 2 minutes with pressure regulator rocking slowly. Let pressure drop of its own accord.**

Nutrition Information Per Serving *7 servings*
254 Calories, 3 g Fat, 0 mg Cholesterol

GRAINS

Grains are an important, but often little recognized, part of a healthy diet. They contribute complex carbohydrates, soluble and insoluble fiber, and other nutrients. Yet with all these benefits, grains are low in fat. Grains can be prepared quickly and conveniently with the pressure cooker. With a pressure cooker it is not necessary to soak or simmer grains for several hours.

During cooking many grains tend to froth, foam, and sputter and could cause the vent pipe to become blocked. Therefore, to contain frothing and foaming during the cooking period, grains must be prepared in a bowl covered with aluminum foil in the pressure cooker. Preparing grains in a bowl also minimizes cleanup which can be difficult if the grains stick to the bottom of the cooker.

The bowl can be metal, such as stainless steel, or oven-safe glass. If using glass, increase cooking time by 1 to 5 minutes depending on the length of the recommended cooking time.

FOR GRAINS, DO NOT FILL PRESSURE COOKER OVER 1/2 FULL!

OPERATING THE COOKER WITHOUT COOKING LIQUID OR ALLOWING THE COOKER TO BOIL DRY WILL DAMAGE THE COOKER.

GRAIN TIMETABLE

Combine the desired grain and the amount of water or broth indicated in the table below in a bowl which fits loosely in the pressure cooker. Cover bowl securely with aluminum foil. Pour two cups water into cooker. Place bowl on rack in cooker. Close cover securely. Place pressure regulator on vent pipe and **cook for the time indicated in the table below. After pressure cooking, allow pressure to drop of its own accord.** Using tongs or hot pads, carefully remove bowl from cooker. Remove foil. Before serving, separate the grains by lifting gently with a fork while steaming. It may be necessary to allow excess moisture to evaporate from some grains. If excessive moisture remains, drain before using grains.

FOR GRAINS, DO NOT FILL PRESSURE COOKER OVER 1/2 FULL!

GRAIN (1 CUP)	CUPS LIQUID IN BOWL	COOKING TIME (MINUTES)
Amaranth	1¼	4 – 5
Barley (Hulled)	2½	25 – 28
Barley (Pearl)	2½	9 – 12
Buckwheat	2	3 – 4
Bulgar	1½	2 – 3
Millet	2	9 – 10
Oats (whole groats)	1½	20 – 25
Oats (steel cut)	2	4 – 5
Quinoa	1½	1
Rice (brown)	1½	10 – 12
Rice (white)	1½	5 – 8
Rye Berries	1½	20 – 25
Spelt	2	25 – 30
Wheat berries	2	25 – 30
Wild Rice	1½	20 – 25

SEASONED RICE PILAF

2 tablespoons margarine	1/2 teaspoon salt
1 small onion, chopped	1/2 teaspoon oregano
2 cups long grain white rice	1/4 teaspoon pepper
2 cups chicken broth	2 cups water
1 3/4 cups water	

Place margarine in cooker. Turn heat selector to medium to melt margarine. Add onions; sauté until tender. Combine onion with rice, broth, 1 3/4 cup water, salt, oregano, and pepper in a metal bowl which will fit loosely in cooker. Cover bowl firmly with aluminum foil. Pour 2 cups water into cooker. Place bowl on rack in cooker. Close cover securely. Place pressure regulator on vent pipe and **cook 5 minutes with pressure regulator rocking slowly. Let pressure drop of its own accord.** Open cooker, remove foil, and set rice aside to steam.

Nutrition Information Per Serving
210 Calories, 4 g Fat, 0 mg Cholesterol

8 servings

VARIATION: GRECIAN RICE PILAF

After pressure has dropped of its own accord, combine rice, 3/4 cup peas, 1/2 cup sliced ripe olives, and 1 red pepper, coarsely chopped. Allow rice to steam uncovered 5 minutes.

LEMON RICE

1 cup long grain rice	2 cups water
1 1/2 cups chicken broth	••••••••
2 teaspoons lemon juice	1/4 teaspoon grated lemon rind
3/4 teaspoon salt	

Combine rice, chicken broth, lemon juice, and salt in a metal bowl which fits loosely in cooker. Cover bowl firmly with aluminum foil. Pour 2 cups water into cooker. Place bowl on rack in cooker. Close cover securely. Place pressure regulator on vent pipe and **cook 5 minutes with pressure regulator rocking slowly. Let pressure drop of its own accord.** Open cooker, remove foil, and set rice aside to steam for 5 minutes. Stir in lemon rind.

Nutrition Information Per Serving
183 Calories, 0 g Fat, 0 mg Cholesterol

4 servings

WILD RICE WITH RAISINS AND PECANS

- | | | | |
|----|------------------------------|----------|---------------------|
| 1 | tablespoon vegetable oil | 2 | cups water |
| 1 | medium onion, finely chopped | •••••••• | |
| 1½ | cups wild rice | ¾ | cup golden raisins |
| 2 | cups beef broth | ⅓ | cup pecans, toasted |

Pour oil into cooker. Turn heat selector to medium and sauté onion. Combine onion with wild rice and beef broth in a metal bowl which fits loosely in cooker. Cover bowl firmly with aluminum foil. Pour water into cooker. Place bowl on rack in cooker. Close cover securely. Place pressure regulator on vent pipe and **cook 25 minutes with pressure regulator rocking slowly. Let pressure drop of its own accord.** Open cooker and remove aluminum foil; add raisins and allow to steam for 5 minutes. Remove bowl from cooker; stir in pecans.

Nutrition Information Per Serving
167 Calories, 5 g Fat, 0 mg Cholesterol

8 servings

RISOTTO WITH ARTICHOKE HEARTS AND SUN-DRIED TOMATOES

- | | | | |
|---|-----------------------------|----|---|
| 1 | tablespoon olive oil | 1 | can (13¾ ounces) artichoke hearts, drained and coarsely chopped |
| 1 | cup arborio rice | | |
| 2 | cloves garlic, minced | ¼ | cup grated Parmesan cheese |
| 2 | cups chicken broth | 1½ | tablespoons fresh thyme or 1½ teaspoons dried thyme |
| ⅓ | cup white wine | | Salt and pepper to taste |
| ⅓ | cup dried tomatoes, chopped | | |
| 2 | cups water | | |
| | •••••••• | | |

Heat oil in pressure cooker over medium heat; add rice and stir for 2 minutes until coated and slightly translucent. Add garlic and cook for 1 minute. Combine rice, garlic, broth, wine, and tomatoes in a metal bowl which fits loosely in cooker. Cover bowl firmly with aluminum foil. Pour water into cooker. Place bowl on rack in cooker. Close cover securely. Place pressure regulator on vent pipe and **cook 8 minutes with pressure regulator rocking slowly. Let pressure drop of its own accord.** Open cooker and remove foil. Stir artichoke hearts, Parmesan cheese, and thyme into rice.

Nutrition Information Per Serving
220 Calories, 5 g Fat, 4 mg Cholesterol

4 servings

DESSERTS

Desserts may be prepared in oven-safe custard cups or any metal mold which will fit loosely in the pressure cooker. Fill molds only $\frac{2}{3}$ full to allow for expansion of food. Cover securely with aluminum foil shaped to the sides of the mold. Place the mold or custard cups on the cooking rack in the cooker. Refer to the chart below for the number of custard cups your cooker will hold and how the custard cups should be positioned on the cooking rack.

To test custards for doneness, insert a knife into the center. If the knife comes out clean, it is done. If not, it will be necessary to bring the cooker back up to pressure and cook the custard a minute or two longer.

Do not cook applesauce, cranberries, or rhubarb in the pressure cooker.

Cooker Stock Number	Quantity of Custard Cups	Positioning Instructions
4-Qt. Aluminum (stock no. 01241)	4	Place two custard cups on cooking rack. Then, stack the other two custard cups opposite the bottom two custard cups.
4-Qt. Stainless (stock no. 01341)	3	Place three custard cups on cooking rack.
6-Qt. Aluminum and 6-Qt. Stainless (stock no. 01264 and 01362)	6	Place three custard cups on cooking rack. Then, stack the other three custard cups opposite the bottom three custard cups.
8-Qt. Aluminum (stock no. 01282)	8	Place four custard cups on cooking rack. Then, stack the other four custard cups opposite the bottom four custard cups.

**FOR DESSERTS, DO NOT FILL
PRESSURE COOKER OVER $\frac{2}{3}$ FULL!**

**OPERATING THE COOKER WITHOUT COOKING LIQUID OR
ALLOWING THE COOKER TO BOIL DRY WILL DAMAGE THE COOKER.**

STUFFED APPLES

¼ cup golden raisins	½ teaspoon ground cinnamon
½ cup dry red wine	4 cooking apples
¼ cup chopped nuts	1 tablespoon butter
2 tablespoons sugar	1 cup water
½ teaspoon grated orange rind	

Soak raisins in wine for at least 30 minutes. Drain, reserving wine. Combine raisins, nuts, sugar, orange rind, and cinnamon. Core apples, cutting to but not through bottoms. Peel top one-third of apples. Place each apple on square of aluminum foil that is large enough to completely wrap apple. Fill centers with raisin mixture. Top each with one-fourth of the butter. Wrap foil around apple, pinching firmly together at top. Place reserved wine, water, and apples in cooker. Place pressure regulator on vent pipe and **cook 10 minutes with pressure regulator rocking slowly. Cool cooker at once.**

Nutrition Information Per Serving
224 Calories, 8 g Fat, 8 mg Cholesterol

4 servings

RICE PUDDING

1 cup long-grain white rice	1 cup whole milk
1½ cups water	½ cup sugar
1 cup water	½ cup raisins
••••••••	½ teaspoon cinnamon

Combine rice and 1½ cups water in a metal bowl which fits loosely in cooker. Cover bowl firmly with aluminum foil. Pour 1 cup water into cooker. Place bowl on rack in cooker. Close cover securely. Place pressure regulator on vent pipe and **cook 10 minutes with pressure regulator rocking slowly. Cool cooker at once.** Stir milk, sugar, raisins, and cinnamon into rice. Cover bowl firmly with aluminum foil. Place bowl on rack in cooker. Close cover securely. Place pressure regulator on vent pipe and **cook 3 minutes with pressure regulator rocking slowly. Let pressure drop of its own accord.**

Nutrition Information Per Serving
238 Calories, 2 g Fat, 24 mg Cholesterol

6 servings

VANILLA CUSTARD

- | | |
|--------------------------------|---------------------------|
| 2 cups lowfat milk | ½ teaspoon vanilla |
| 2 eggs, slightly beaten | Nutmeg |
| ¼ cup sugar | 1 cup water |
| ¼ teaspoon salt | |

Combine milk, eggs, sugar, salt, and vanilla. Pour into individual custard cups. Sprinkle nutmeg on custards. Cover each cup firmly with aluminum foil. Pour water into cooker. Place custard cups on rack in cooker. Close cover securely. Place pressure regulator on vent pipe and **cook 5 minutes with pressure regulator rocking slowly. Cool cooker at once.** Chill.

Nutrition Information Per Serving *4 servings*
137 Calories, 4 g Fat, 118 mg Cholesterol

PETITE PUMPKIN CUSTARDS

- | | |
|---|---|
| 1 can (16 ounces) solid-pack pumpkin | 1 teaspoon finely chopped candied ginger, optional |
| 1 can (14 ounces) sweetened condensed milk | ¼ teaspoon ground cloves |
| 3 eggs, beaten | 1 cup water |
| 1 teaspoon ground cinnamon | •••••• |
| | Whipped cream, optional |

Mix pumpkin, milk, eggs, cinnamon, ginger, and cloves. Pour into individual custard cups. Cover each cup firmly with aluminum foil. Pour water into cooker. Place custard cups on rack in cooker. Close cover securely. Place pressure regulator on vent pipe and **cook 10 minutes with pressure regulator rocking slowly. Cool cooker at once.** Refrigerate until chilled. Serve with whipped cream, if desired.

Nutrition Information Per Serving *8 servings*
207 Calories, 6 g Fat, 97 mg Cholesterol

TAPIOCA PUDDING

- | | |
|--|---------------------------|
| 2 cups lowfat milk | ⅓ cup sugar |
| 2 tablespoons quick cooking tapioca | ½ teaspoon vanilla |
| 2 eggs, slightly beaten | 1 cup water |

Scald milk and tapioca. Remove from heat and let stand 15 minutes. Combine eggs, sugar, and vanilla. Add milk and tapioca, stirring constantly. Pour into individual custard cups. Cover firmly with aluminum foil. Pour water into cooker. Place custard cups on rack in cooker. Place pressure regulator on vent pipe and **cook 5 minutes with pressure regulator rocking slowly. Cool cooker at once.** Chill.

Nutrition Information Per Serving *6 servings*
113 Calories, 3 g Fat, 75 mg Cholesterol

OATMEAL APPLE CRISP

4 cups apples, peeled and sliced	2 tablespoons flour
1 tablespoon lemon juice	1 teaspoon cinnamon
½ cup quick cooking oats	2 tablespoons margarine, softened
¼ cup brown sugar	2 cups water

Sprinkle apples with lemon juice. Combine oats, brown sugar, flour, and cinnamon. Cut in margarine until coarse meal forms. Place apples in a greased bowl that will loosely fit in cooker. Sprinkle oat mixture evenly over apples. Cover bowl firmly with aluminum foil. Pour water into cooker. Place bowl on rack in cooker. Close cover securely. Place pressure regulator on vent pipe and **cook 20 minutes with pressure regulator rocking slowly. Cool cooker at once.**

Nutrition Information Per Serving
209 Calories, 7 g Fat, 0 Cholesterol

4 servings

CHEESECAKE

1 8-ounce package cream cheese	2 eggs
1 3-ounce package cream cheese	½ cup vanilla wafer crumbs
½ cup sugar	2½ cups water

Beat cream cheese until smooth. Add sugar and beat in eggs. Pour mixture into buttered custard cups. Top with vanilla wafer crumbs. Cover each cup firmly with aluminum foil. Pour water into cooker. Place custard cups on rack in cooker. Close cover securely. Place pressure regulator on vent pipe and **cook 15 minutes with pressure regulator rocking slowly. Cool cooker at once.** Cool cheesecake. Cut around inside of cups to loosen and invert onto serving dish. Chill. Top with one of the following sauces, if desired.

Nutrition Information Per Serving
305 Calories, 23 g Fat, 157 Cholesterol

6 servings

CARAMEL SAUCE — Combine ¼ cup soft cream cheese, ¼ cup brown sugar, 1 tablespoon granulated sugar, and ¼ teaspoon vanilla. Mix thoroughly. Spoon over cheesecake. Garnish with pecans. Refrigerate until serving.

FRUIT SAUCE — Spoon canned fruit pie filling of your choice over cheesecake. Refrigerate until serving.

RECIPE INDEX

SOUPS AND STOCKS24

Beef Tomato Soup	26
Black Bean Soup	26
Brown Beef Soup	25
Brown Beef Soup Stock	26
Chicken Dumpling Soup	25
Chicken Noodle Soup	25
Chicken Rice Soup	25
Chicken Soup	25
Chicken Soup Stock	25
Minestrone	27
Onion Soup	26
Potato Soup	28
Saffron Fish Stew	27
Zesty Homemade Chili	28

SEAFOOD29

Lemon 'N Dill Cod and Broccoli	31
Marinated Tuna	32
Salmon Steaks Moutarde	29
"Scampi Style" Shrimp	30
Seafood Gumbo	31
Seafood Timetable	32
Shrimp Jambalaya	30

POULTRY33

Bayou Bounty Chicken	36
California Chicken	34
Chicken Breasts Tarragon	33
Chicken Cacciatore	35
Chicken and Dressing	37
Chutney Chicken	34
Herbed Chicken	36
Poultry Timetable	38
Soy Chicken	34
Sweet 'N Sour Chicken	35
Turkey Breast	37

MEATS39

Apricot Barbecue Pork Roast	42
Barbecue Spareribs	42
Beef Pot Roast	40
Beef Stew	41

Corned Beef	43
Lamb Stew	44
Meat Timetable	45
Porcupine Meatballs	40
Pork Loin Roast	43
Spaghetti Meat Sauce	41
Stuffed Flank Steak	44
Stuffed Pork Chops	43
Swiss Steak	40

VEGETABLES46

Artichokes 'N Sauce	48
Cabbage with Apples	47
Fresh Vegetable Timetable	50
Frozen Vegetable Timetable	52
Garlic Mashed Potatoes	48
Glazed Root Vegetables	47
Maple Glazed Sweet Potatoes	49

DRY BEANS AND PEAS53

Baked Beans	55
Dry Beans and Peas Timetable	54
Lentil Curry	54
Savory White Beans	55

GRAINS56

Grain Timetable	57
Grecian Rice Pilaf	58
Lemon Rice	58
Risotto with Artichoke Hearts and Sun-Dried Tomatoes	59
Seasoned Rice Pilaf	58
Wild Rice with Raisins and Pecans	59

DESSERTS60

Cheesecake	63
Oatmeal Apple Crisp	63
Petite Pumpkin Custards	62
Rice Pudding	61
Stuffed Apples	61
Tapioca Pudding	62
Vanilla Custard	62

SERVICE AND PARTS INFORMATION

If you have any questions regarding the operation of your Presto® cooker or need parts for your cooker, contact us by any of these methods:

- **Call 1-800-877-0441** weekdays 8:00 AM to 4:30 PM
(Central Time)
- **Email us at our website www.GoPresto.com**
- **Write:** NATIONAL PRESTO INDUSTRIES, INC.
Consumer Service Department
3925 N. Hastings Way, Eau Claire, WI 54703-3703

Inquiries will be answered promptly by telephone, email, or letter. When writing, please include a phone number and a time when you can be reached during weekdays, if possible.

When contacting the Consumer Service Department or when ordering replacement parts, please specify the 7-digit model number and date code found stamped on the side of the cooker body.

Please record this information:

Model Number _____ Date Code _____ Date Purchased _____

Any maintenance required for this cooker, other than that described in the Cleaning and Care and Maintenance sections of this book (pages 15 through 18), should be performed by our Factory Service Department. Be sure to indicate date of purchase and a description of the problem when sending a cooker for repair.

Send cookers for repair to:

CANTON SALES AND STORAGE COMPANY
Presto Factory Service Department
555 Matthews Drive, Canton, MS 39046-0529

The Presto Factory Service Department is equipped to service all PRESTO® appliances and supply genuine PRESTO® parts. Genuine PRESTO® replacement parts are manufactured to the same exacting

quality standards as PRESTO® appliances and are engineered specifically to function properly with its appliances. Presto can only guarantee the quality and performance of genuine PRESTO® parts. "Look-alikes" might not be of the same quality or function in the same manner. To ensure that you are buying genuine PRESTO® replacement parts, look for the PRESTO® trademark.

Cooker replacement parts are available at hardware stores and other retail outlets. Parts may also be ordered on-line at www.GoPresto.com.

PRESTO® Limited Warranty

This quality PRESTO® appliance is designed and built to provide many years of satisfactory performance under normal household use. Presto pledges to the original owner that should there be any defects in material or workmanship during the first twelve (12) years after purchase, we will repair or replace it at our option. Our pledge does not apply to normal wear and tear including scratches, dulling of the polish, or staining; the repair or replacement of moving and/or perishable parts such as the sealing ring, overpressure plug, or air vent cover lock gasket; or for any damage caused by shipping. To obtain service under the warranty, return this PRESTO® product, shipping prepaid to the PRESTO® Factory Service Department. When returning a product, please include a description of the defect and indicate the date the appliance was purchased.

We want you to obtain maximum enjoyment from using this PRESTO® appliance and ask that you read and follow the instructions enclosed. Failure to follow instructions, damage caused by improper replacement parts, abuse or misuse (including overheating and boiling the unit dry) will void this pledge. This warranty gives you specific legal rights, and you may also have other rights which vary from state to state. This is Presto's personal pledge to you and is being made in place of all other express or implied warranties.

NATIONAL PRESTO INDUSTRIES, INC.
Eau Claire, Wisconsin 54703-3703