

This Owner's Manual is provided and hosted by [Appliance Factory Parts](#).

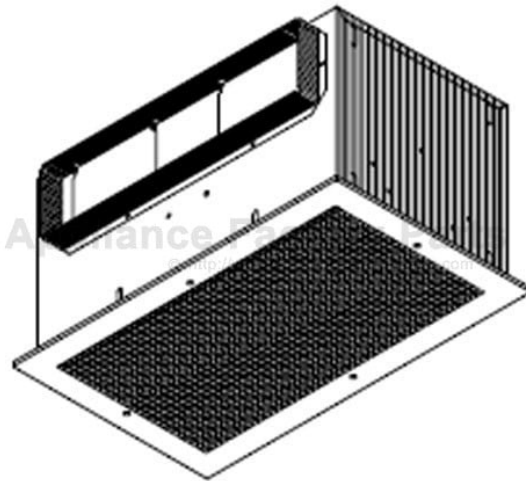

BROAN L700C Owner's Manual

[Shop genuine replacement parts for BROAN L700C](#)



[Find Your BROAN HVAC Parts - Select From 1309 Models](#)

----- Manual continues below -----

LOSONE SELECT® CEILING MOUNT VENTILATORS L400EX, L400C, L500EX, L500C, L700EX, L700C

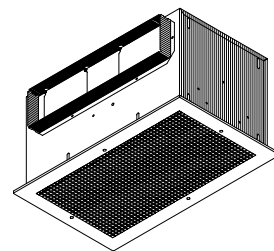

Incredibly reliable. Unbelievably quiet. Offering the CFM choices you need at the lowest sound levels in the industry.

FEATURES

GRILLE:

- Conceals interior
- Low profile styling blends with any decor

BLOWER:

- Low RPM for quiet operation
- Resilient anti-vibration mounts
- Balanced, polymeric, centrifugal blower wheel for quiet, efficient performance
- Permanently lubricated, thermally protected motor
- Plug-in motor rated at ("EX" models - 240 VAC), ("C" models - 277 VAC)
- Designed for continuous operation

HOUSING:

- Rugged, 20 gauge galvanized steel
- 4½" x 18½" duct connector
- 1/2" acoustic insulation inside
- May be installed in ceiling or wall (size permitting)
- 8-position mounting brackets for easy installation and greater adaptability to various mounting requirements
- Automatic backdraft damper located within duct connector
- Factory-shipped in horizontal discharge position - easily converted to vertical discharge
- May be installed as an in-line ventilator with addition of accessory kit Model 982L (purchase separately)

ACCESSORIES (purchase all separately):

- Model 57V (Ivory) / 57W (White) 3 amp Electronic Variable Speed Control
- Model 59V (Ivory) / 59W (White) 60-Minute Time Control
- Model 61V (Ivory) / 61W (White) 15-Minute Time Control

ACCESSORIES (continued):

- Model 71V (Ivory) / 71W (White) 12-Hour Time Control
- 6-Amp, Electronic Variable Speed Controls Model 75V (240 VAC), Model 277V (277 VAC)
- Model 423 Transition (4½" x 18½" to 10" round)
- Model RD2 Radiation Damper

TYPICAL SPECIFICATION

Ventilator shall be Broan Model L400EX, (L400C), (L500EX), (L500C), (L700EX), (L700C).

Ventilator shall have galvanized steel housing insulated with at least 1/2" of acoustic insulation. Housing to have adjustable mounting brackets.

Automatic backdraft damper to be located within duct connector. Duct connector, blower assembly, and wiring plate shall be adjustable for either horizontal or vertical installation.

Blower unit shall be removable from housing and will have a polymeric, balanced centrifugal-type blower wheel. Motor to be permanently lubricated and mounted with resilient anti-vibration mounts. RPM not to exceed number listed for each model.

Air delivery shall be no less and sound levels no greater than listed for each model. All air and sound ratings shall be certified by AMCA. Units to be UL and cUL listed.



"Broan-NuTone LLC certifies that the models shown herein are licensed to bear the AMCA Seal. The ratings shown are based on tests and procedures performed in accordance with AMCA Publication 211 (and AMCA Publication 311 if sound is also certified) and comply with the requirements of the AMCA Certified Ratings Program"



Broan-NuTone LLC, 926 West State Street, Hartford, Wisconsin 53027 (1-800-637-1453)
Broan-NuTone Canada, 1140 Tristar Drive, Mississauga, Ontario, L5T 1H9 (1-888-882-7626)

REFERENCE	QTY.	REMARKS	Project
			Location
			Architect
			Engineer
			Contractor
			Submitted by Date

PERFORMANCE RATINGS - LOSONE SELECT® CEILING MOUNT VENTILATORS L400EX, L400C, L500EX, L500C, L700EX, L700C

AMCA LICENSED PERFORMANCE

CFM / SONES - AT STATIC PRESSURES (Ps - inches of H ₂ O)															
MODEL NO.	NOMINAL VOLTAGE		0.0" Ps	.10" Ps	.125" Ps	.250" Ps	.375" Ps	.50" Ps	.625" Ps	.750" Ps	.875" Ps	1.0" Ps	NOMINAL RPM	AMPS @60 Hz	WATTS
L400EX	240 VAC	CFM Hor.	480	442	434	388	344	299	229	182	114	33	735	.64	150
		SONES Hor.	2.0	2.4	2.3	2.8	3.3	3.8	4.5	4.8	5.4	5.6			
L400C	277 VAC	CFM Ver.	467	428	416	378	335	291	237	170	85	8	755	.64	150
		SONES Ver.	2.3	2.6	2.6	3.0	3.5	4.0	5.1	5.5	5.7	5.9			
L500EX	240 VAC	CFM Hor.	538	520	514	491	463	434	389	339	282	186	810	1.1	235
		SONES Hor.	3.0	3.1	3.3	3.6	4.0	4.4	5.0	5.7	6.2	6.7			
L500C	277 VAC	CFM Ver.	539	517	512	481	451	418	367	319	247	137	865	1.1	235
		SONES Ver.	2.9	3.1	3.2	3.4	3.8	4.2	4.8	5.9	6.3	6.4			
L700EX	240 VAC	CFM Hor.	722	704	701	667	640	607	571	534	453	333	960	1.1	243
		SONES Hor.	4.5	4.6	4.7	4.8	5.0	5.2	5.6	6.2	7.1	7.2			
L700C	277 VAC	CFM Ver.	708	691	687	658	628	597	560	515	444	312	985	1.1	243
		SONES Ver.	5.2	5.0	5.0	5.7	5.8	6.1	6.4	7.4	7.1	7.6			
L700C	277 VAC	CFM Hor.	722	704	701	667	640	607	571	534	453	333	960	1.2	299
		SONES Hor.	4.5	4.6	4.7	4.8	5.0	5.2	5.6	6.2	7.1	7.2			
L700C	277 VAC	CFM Ver.	708	691	687	658	628	597	560	515	444	312	985	1.2	299
		SONES Ver.	5.2	5.0	5.0	5.7	5.8	6.1	6.4	7.4	7.1	7.6			

Performance ratings include the effects of inlet grille and backdraft damper in the airstream. Speed (RPM) shown is nominal. Performance is based on actual speed of test. The sound ratings shown are loudness values in fan sones at 5' (1.5m) in a hemispherical free field calculated per AMCA Std. 301. Values shown are for Installation Type B: Free inlet fan sone levels. Performance shown is for Installation Type B: Free inlet, Ducted outlet.



"Broan-NuTone LLC certifies that the models shown herein are licensed to bear the AMCA Seal. The ratings shown are based on tests and procedures performed in accordance with AMCA Publication 211 (and AMCA Publication 311 if sound is also certified) and comply with the requirements of the AMCA Certified Ratings Program."

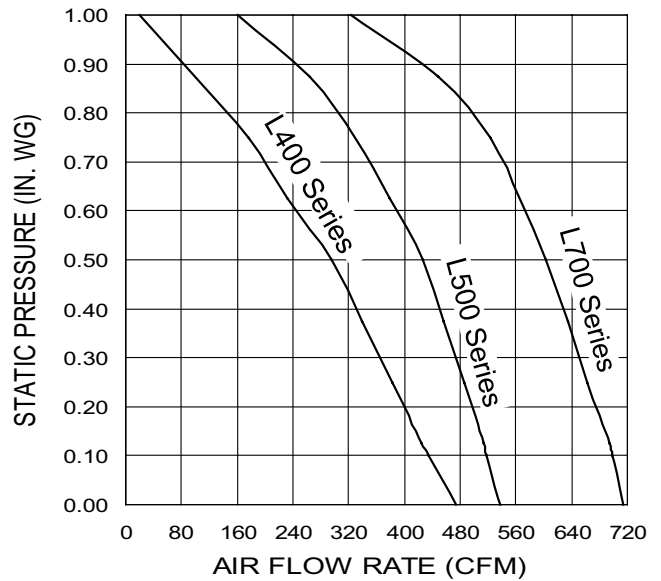
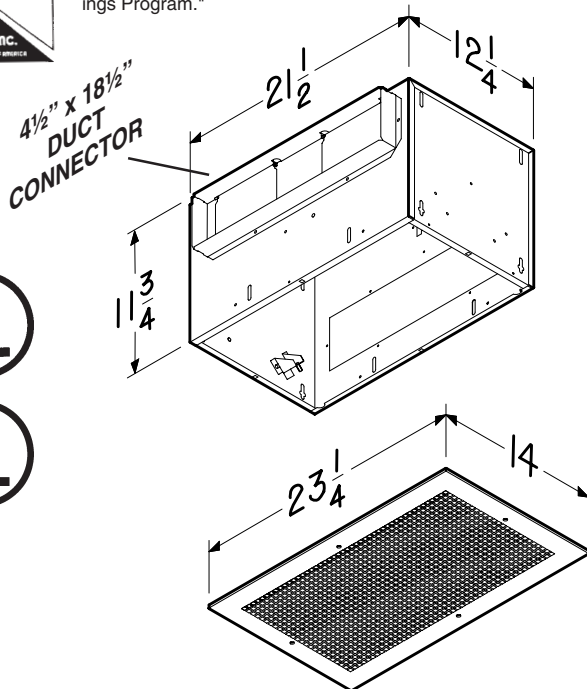

WEIGHT

MODEL NO.	SHIPPING WT.
L400EX, L400C L500EX, L500C	33.8 lbs.
L700EX, L700C	33.9 lbs.



Broan-NuTone LLC, 926 West State Street, Hartford, Wisconsin 53027 (1-800-637-1453)
Broan-NuTone Canada, 1140 Tristar Drive, Mississauga, Ontario, L5T 1H9 (1-888-882-7626)