

This Owner's Manual is provided and hosted by [Appliance Factory Parts](#).

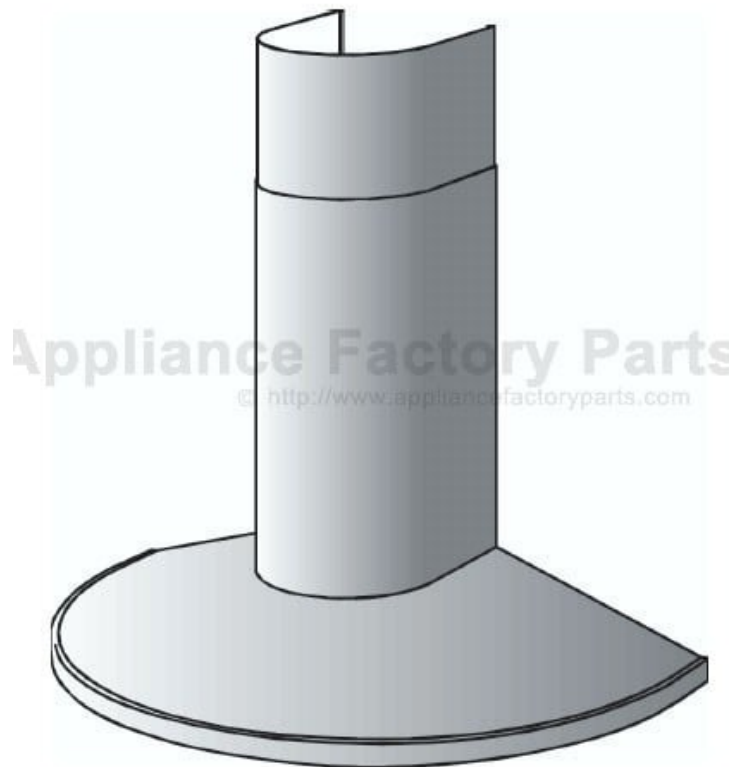

BROAN RM519004 Owner's Manual

[Shop genuine replacement parts for BROAN RM519004](#)



[Find Your BROAN HVAC Parts - Select From 1309 Models](#)

----- Manual continues below -----

RANGEMASTER

RM51000 RM52000 Series

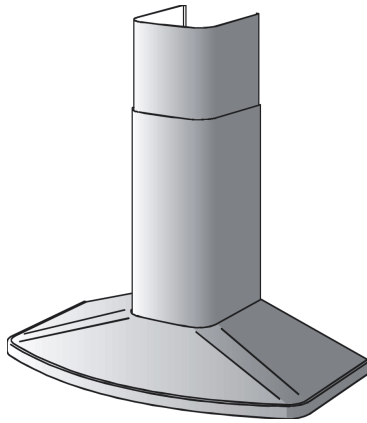
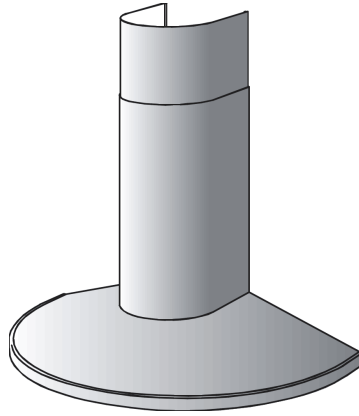

ENGLISH.....	3
FRANÇAIS.....	12
ESPAÑOL.....	21

Broan-NuTone LLC, 926 West State Street, Hartford, WI 53027
NuTone, Inc., 4820 Red Bank Road, Cincinnati, OH 45227
Broan-NuTone Canada, INC.1140 Tristar Drive, Mississauga, Ontario, L5T 1H9

READ AND SAVE THESE INSTRUCTIONS

WARNING

SUITABLE FOR USE IN HOUSEHOLD COOKING AREA.

TO REDUCE THE RISK OF FIRE, ELECTRICAL SHOCK, OR INJURY TO PERSONS, OBSERVE THE FOLLOWING:

1. Use this unit only in the manner intended by the manufacturer. If you have questions, contact the manufacturer at the address or telephone number listed in the warranty.
2. Before servicing or cleaning unit, switch power off at service panel and lock service panel to prevent power from being switched on accidentally. When the service disconnecting means cannot be locked, securely fasten a prominent warning device, such as a tag, to the service panel.
3. Installation work and electrical wiring must be done by a qualified person(s) in accordance with all applicable codes and standards, including fire-rated construction codes and standards.
4. Sufficient air is needed for proper combustion and exhausting of gases through the flue (chimney) of fuel burning equipment to prevent backdrafting. Follow the heating equipment manufacturer's guidelines and safety standards such as those published by the National Fire Protection Association (NFPA), and the American Society for Heating, Refrigeration and Air Conditioning Engineers (ASHRAE), and the local code authorities.
5. When cutting or drilling into wall or ceiling, do not damage electrical wiring and other hidden utilities.
6. Ducted fans must always be vented to the outdoors.
7. Do not use this unit with any solid-state speed control device.
8. To reduce the risk of fire, use only steel ductwork.
9. This unit must be grounded.

TO REDUCE THE RISK OF A RANGE TOP GREASE FIRE:

- A. Never leave surface units unattended at high settings. Boilovers cause smoking and greasy spillovers that may ignite. Heat oils slowly on low or medium settings.
- B. Always turn hood ON when cooking at high heat or when cooking flaming foods.
- C. Clean ventilating fans frequently. Grease should not be allowed to accumulate on fan or filter.
- D. Use proper pan size. Always use cookware appropriate for the size of the surface element.

WARNING

TO REDUCE THE RISK OF INJURY TO PERSONS IN THE EVENT OF A RANGE TOP GREASE FIRE, OBSERVE THE FOLLOWING:*

1. SMOTHER FLAMES with a close-fitting lid, cookie sheet, or metal tray, then turn off the burner. BE CAREFUL TO PREVENT BURNS. If the flames do not go out immediately, EVACUATE AND CALL THE FIRE DEPARTMENT.
 2. NEVER PICK UP A FLAMING PAN - You may be burned.
 3. DO NOT USE WATER, including wet dishcloths or towels - violent steam explosion will result.
 4. Use an extinguisher ONLY if:
 - A. You know you have a Class ABC extinguisher and you already know how to operate it.
 - B. The fire is small and contained in the area where it started.
 - C. The fire department is being called.
 - D. You can fight the fire with your back to an exit.
- * Based on "Kitchen Fire Safety Tips" published by NFPA.

CAUTION

1. To reduce risk of fire and to properly exhaust air, be sure to duct air outside. Do not vent exhaust air into spaces within walls or ceilings or into attics, crawl spaces, or garages.
2. Take care when using cleaning agents or detergents.
3. Avoid using food products that produce flames under the Range Hood.
4. For general ventilating use only. Do not use to exhaust hazardous or explosive materials and vapors.
5. To avoid motor bearing damage and noisy and/or unbalanced impellers, keep drywall spray, construction dust, etc. off power unit.
6. Your hood motor has a thermal overload which will automatically shut off the motor if it becomes overheated. The motor will restart when it cools down. If the motor continues to shut off and restart, have the hood serviced.
7. For best capture of cooking impurities, the bottom of the hood should be a minimum of 24" and a maximum of 30" above the cooking surface.
8. Two installers are recommended because of the large size and weight of this hood.
9. Please read specification label on product for further information and requirements.

PREPARE THE HOOD

Unpack hood and check contents.

You should receive:

- 1 - Hood
- 1 - Decorative Flue Assembly
- 1 - Parts Bag containing:
 - 1 - Mounting Bracket
 - 1 - Discharge Collar
 - 1 - Flue Mounting Bracket
 - 8 - Mounting Screws (4,8 x 38mm Pan Head)
 - 5 - Mounting Screws (3,9 x 9,5mm Pan Head)
 - 8 - Drywall Anchors
- 1 - Installation Instructions

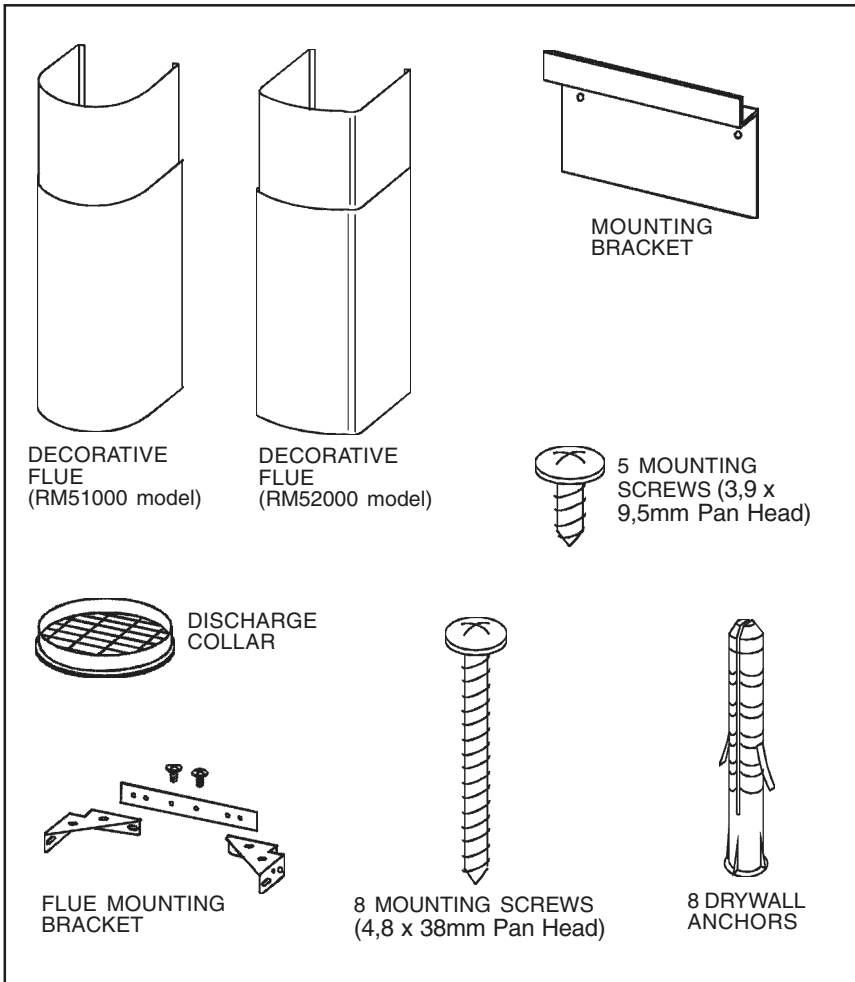

INSTALL THE DUCTWORK

NOTE: To reduce the risk of fire, use only metal ductwork.

1. Decide where the ductwork will run between the hood and the outside.
2. A straight, short duct run will allow the hood to perform most efficiently.
3. Long duct runs, elbows, and transitions will reduce the performance of the hood. Use as few of them as possible. Larger ducting may be required for best performance with longer duct runs.
4. Install a roof or wall cap. Connect round metal ductwork to cap and work back towards hood location. Use duct tape to seal the joints between ductwork sections.

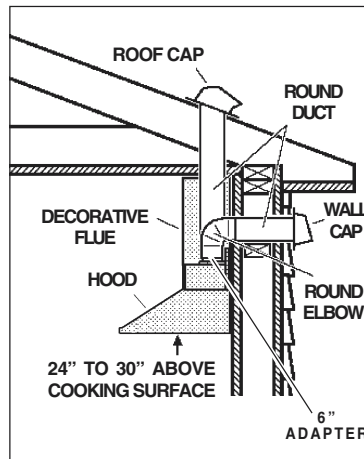

INSTALL MOUNTING BRACKET

1. Construct wood wall **framing** that is **flush** with interior surface of wall studs. Make sure:
 - a) the framing is centered over installation location.
 - b) the height of the framing will allow the **mounting bracket** to be secured to the framing within the dimensions shown.
2. After wall surface is finished, secure mounting bracket to framing using dimensions shown.

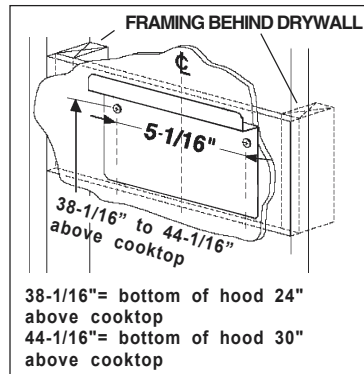

INSTALL THE HOOD

1. Hang the hood from the bracket through the **rectangular cut-out** on the back of the hood. Cut-out is larger than the bracket to allow for horizontal adjustment. The bottom of the hood should be 24" to 30" above the cooking surface.
2. Secure the hood with **mounting screws**. Use drywall anchors, provided, if wall studs or framing are not available.

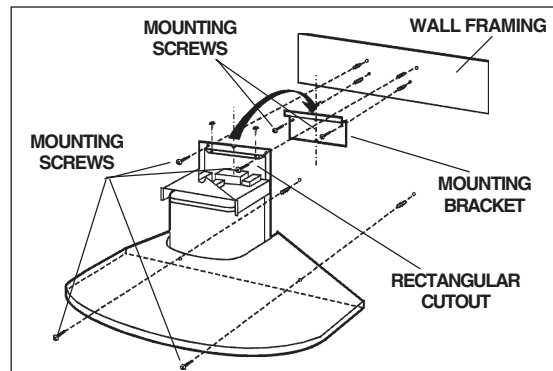

MOUNT THE PLATE

Mount the plate of the electrical system attaching it with 3 screws.

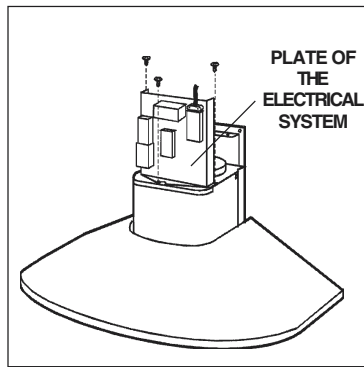

WIRING

Note: This range hood must be properly grounded. The unit should be installed by a qualified electrician in accordance with all applicable national and local electrical codes.

GROUNDING INSTRUCTIONS

This appliance must be grounded. In the event of an electrical short circuit, grounding reduces the risk of electric shock by providing an escape wire for the electric current. This appliance is equipped with a cord having a grounding wire with a grounding plug. The plug must be plugged into an outlet that is properly installed and grounded.

WARNING - Improper grounding can result in a risk of electric shock.

Consult a qualified electrician if the grounding instructions are not completely understood, or if doubt exists as to whether the appliance is properly grounded. Do not use an extension cord. If the power supply cord is too short, have a qualified electrician install an outlet near the appliance.

Set the electrical power supply within the space covered by the decorative flues. Position the power socket at a maximum distance of 33-7/16" (85 cm) from where the lead exits from the hood (see illustration alongside). Make sure this does not interfere with the bracket fastening area or with the decorative flue (where the flue touches the wall).

Fit the plug into the power socket.

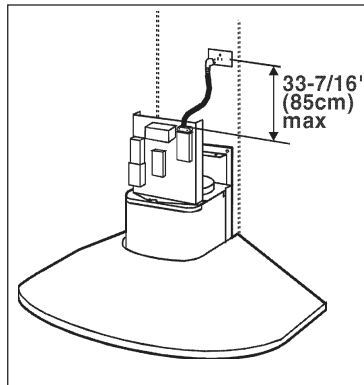

CONNECT DUCTWORK

Ducted Configuration

1. Adjust the width of the flue mounting bracket to equal the inside width of decorative flue. Insert and tighten mounting screws to hold bracket width.
2. Use mounting screws and wall anchors to secure **flue mounting bracket** to the ceiling as shown.
3. Use **6" round metal duct** to connect the duct collar on the hood to the ductwork above.
4. Use **duct tape** to make all joints secure and air tight.
5. Insert the decorative flues setting them on the hood.
6. Extend the upper flue to the ceiling and secure with two mounting screws.

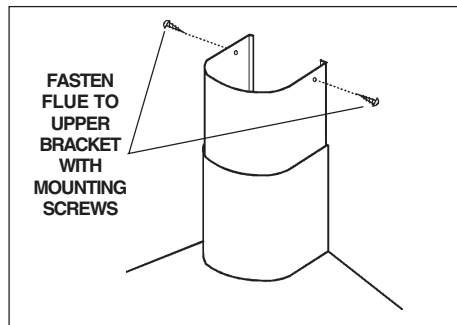
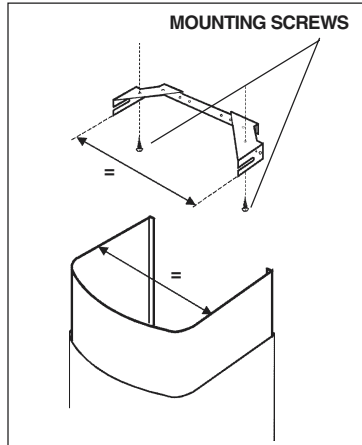
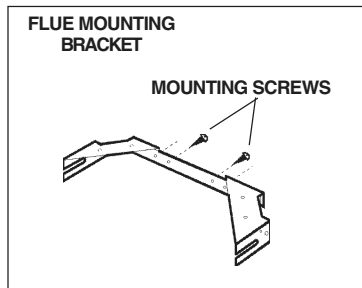
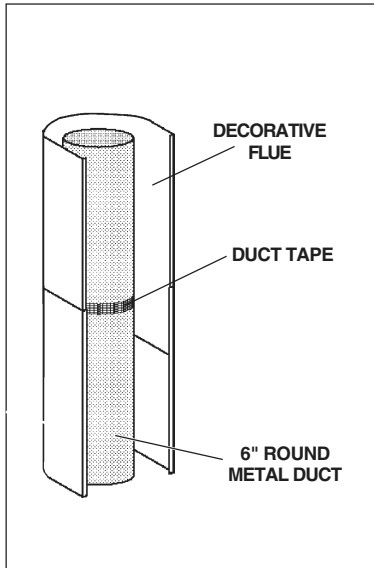

Non-ducted recirculation Configuration

1. Adjust the width of the flue mounting bracket to equal the inside width of decorative flue. Insert and tighten mounting screws to hold bracket width.
2. Use mounting screws and wall anchors to secure **flue mounting bracket** to the ceiling as shown.
3. Turn **upper flue section** upside down so **air vents** are at the top. Slide upper flue section into **lower flue section**.
4. Connect the non-ducted recirculation plenum to the upper flue section with (4) flat-head screws (supplied).
5. Install the reduction on the discharge collar.
6. Measure the distance from the top of the **reduction** to the ceiling. Cut a length of **5" round metal duct** 5" shorter than this dimension.
7. Fit duct section over the non-ducted recirculation plenum. For best fit, make sure **duct seam** is toward the front.
8. Set duct/flue assembly on hood with top tilted away from wall. Reach around bottom of duct with discharge collar on hood. Tilt flue up against wall. Duct seam can be cut to length if necessary.
9. Extend the upper flue to the ceiling and secure with two mounting screws.

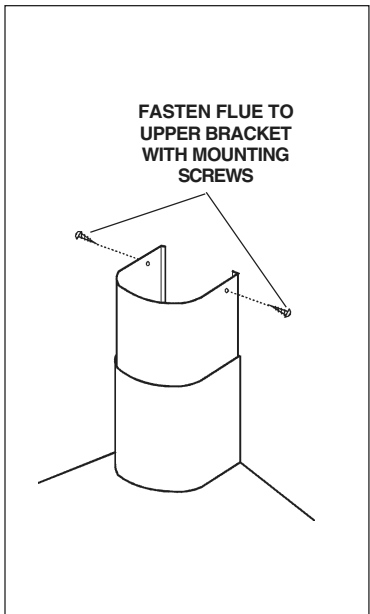
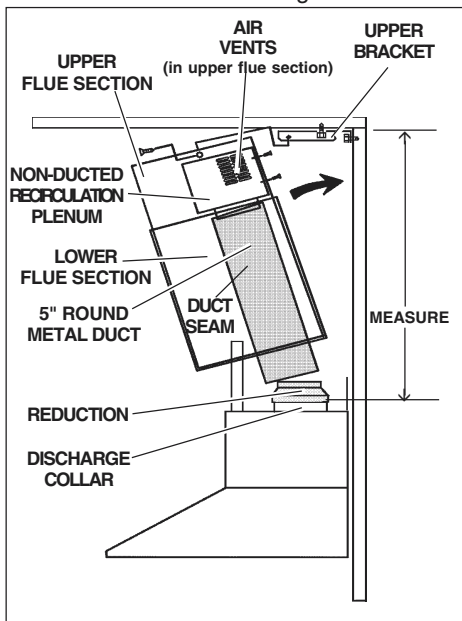
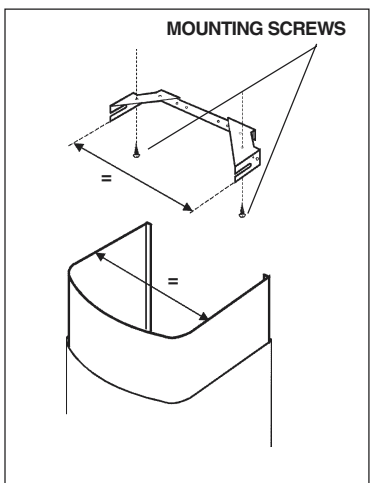
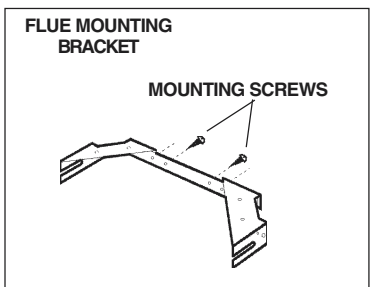

NON-DUCTED RECIRCULATION FILTER INSTALLATION

1. Purchase a charcoal filter (B03300488) from your dealer.
2. Install the filter by pressing the 2 tabs on the filter down into the special housing and rotating upward.

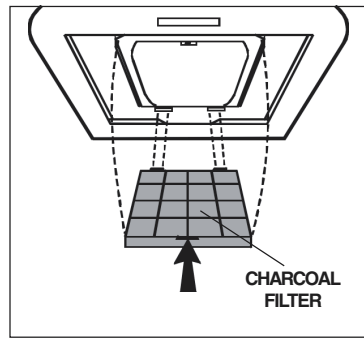

MAINTENANCE

Proper maintenance of the Range Hood will assure proper performance of the unit.

Grease Filters

The **grease filters** should be cleaned frequently. Use a warm detergent solution. Grease filters are dishwasher safe.

Remove filter by pushing filter towards the back of hood and rotating filter downward.

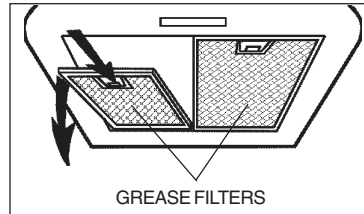

Charcoal Filter

The charcoal filter should be changed every 6 months. To remove the filter press inward on the clamp and rotate the filter downward until the 2 tabs can be removed from the housing.

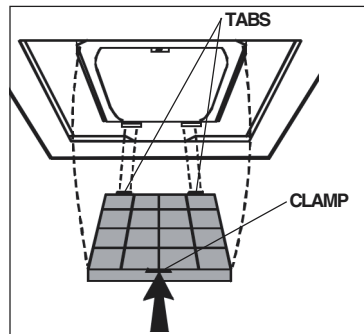

Hood Cleaning

Stainless steel is one of the easiest materials to keep clean. Occasional care will help preserve its fine appearance.

Cleaning tips:

- Hot water with soap or detergent is all that is usually needed.
- Follow all cleaning by rinsing with clear water. Wipe dry with a clean, soft cloth to avoid water marks.
- For discolorations or deposits that persist, use a non-scratching household cleanser or stainless steel polishing powder with a little water and a soft cloth.
- For stubborn cases, use a plastic scouring pad or soft bristle brush together with cleanser and water. Rub lightly in direction of polishing lines or "grain" of the stainless finish. Avoid using too much pressure which may mar the surface.
- **DO NOT** allow deposits to remain for long periods of time.
- **DO NOT** use ordinary steel wool or steel brushes. Small bits of steel may adhere to the surface causing rust.
- **DO NOT** allow salt solutions, disinfectants, bleaches, or cleaning compounds to remain in contact with stainless steel for extended periods. Many of these compounds contain chemicals which may be harmful. Rinse with water after exposure and wipe dry with a clean cloth.

Painted surfaces should be cleaned with warm water and mild detergent only.

OPERATION

Controls

The hood is operated using the slide controls under the bottom of the hood.

The **light switch** turns the lamps on and off.

The **blower switch** makes it possible to select the motor operating speed. Position 0: motor off.

The **pilot lamp** lights up whenever the blower is on.

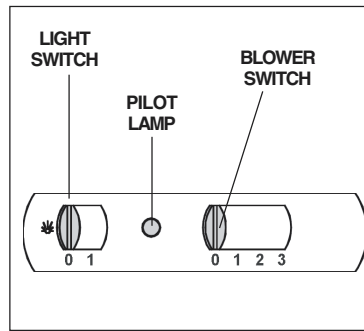

HALOGEN BULBS

This range hood requires two halogen bulbs (Type T4, 12V, 20W).

ALWAYS SWITCH OFF THE ELECTRICITY SUPPLY BEFORE CARRYING OUT ANY OPERATIONS ON THE APPLIANCE.

To change bulbs:

1. Loosen the ring nut by turning it counterclockwise.
2. Remove the bulb by pulling sideward (DO NOT ROTATE). **CAUTION: BULB MAY BE HOT!**
3. Replace with Type T4, 12V, 20W halogen bulb. Do not touch replacement bulb with bare hands!

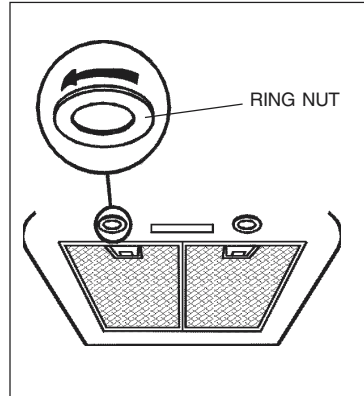

FUSE REPLACEMENT

SWITCH OFF THE ELECTRICITY SUPPLY.

Remove the decorative flue.

Open the fuse box.

Replace with the same type of fuse (5x20mm, 4A, 125V).

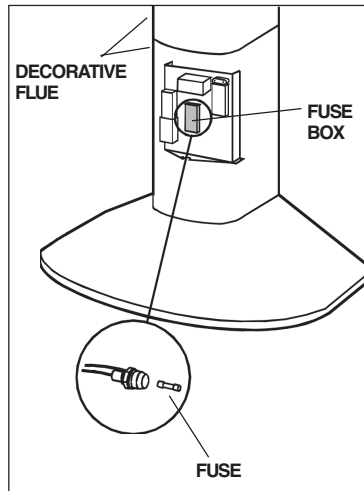

WARRANTY

BROAN-NUTONE LLC ONE YEAR LIMITED WARRANTY

Broan-NuTone LLC warrants to the original consumer purchaser of its products that such products will be free from defects in materials or workmanship for a period of one year from the date of original purchase. THERE ARE NO OTHER WARRANTIES, EXPRESS OR IMPLIED, INCLUDING, BUT NOT LIMITED TO, IMPLIED WARRANTIES OR MERCHANTABILITY OR FITNESS FOR A PARTICULAR PURPOSE.

During this one-year period, Broan-NuTone LLC will, at its option, repair or replace, without charge, any product or part which is found to be defective under normal use and service.

THIS WARRANTY DOES NOT EXTEND TO FLUORESCENT LAMP STARTERS, TUBES, HALOGEN AND INCANDESCENT BULBS. This warranty does not cover (a) normal maintenance and service or (b) any products or parts which have been subject to misuse, negligence, accident, improper maintenance or repair (other than by Broan-NuTone LLC), faulty installation or installation contrary to recommended installation instructions.

The duration of any implied warranty is limited to the one-year period as specified for the express warranty. Some states do not allow limitation on how long an implied warranty lasts, so the above limitation may not apply to you.

BROAN-NUTONE LLC'S OBLIGATION TO REPAIR OR REPLACE, AT BROAN-NUTONE LLC'S OPTION, SHALL BE THE PURCHASER'S SOLE AND EXCLUSIVE REMEDY UNDER THIS WARRANTY. BROAN-NUTONE LLC SHALL NOT BE LIABLE FOR INCIDENTAL, CONSEQUENTIAL OR SPECIAL DAMAGES ARISING OUT OF OR IN CONNECTION WITH PRODUCT USE OR PERFORMANCE. Some states do not allow the exclusion or limitation of incidental or consequential damages, so the above limitation or exclusion may not apply to you.

This warranty gives you specific legal rights, and you may also have other rights, which vary from state to state. This warranty supersedes all prior warranties.

To qualify for warranty service, you must (a) notify Broan-NuTone LLC at the address stated below or telephone: 1-800-637-1453, (b) give the model number and part identification and (c) describe the nature of any defect in the product or part. At the time of requesting warranty service, you must present evidence of the original purchase date.

Broan-NuTone LLC, 926 West State Street, Hartford, WI 53027 (1-800-637-1453)

NuTone, Inc., 4820 Red Bank Road, Cincinnati, OH 45227 (1-800-543-8687)

Broan-NuTone Canada, Inc. 1140 Tristar Drive, Mississauga, Ontario, L5T 1H9 (1-888-882-7626)