

This Owner's Manual is provided and hosted by [Appliance Factory Parts](#).



BROAN QS142WW Owner's Manual

[Shop genuine replacement parts for BROAN QS142WW](#)



[Find Your BROAN HVAC Parts - Select From 1309 Models](#)

----- Manual continues below -----

ALLURE™ QS1 SERIES RANGE HOODS

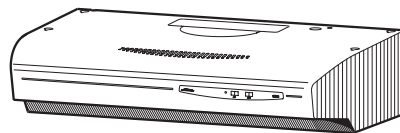

Page 1

Patent No.:
US D450, 829 S

READ AND SAVE THESE INSTRUCTIONS

! FOR DOMESTIC COOKING ONLY. !

WARNING



TO REDUCE THE RISK OF FIRE, ELECTRIC SHOCK, OR INJURY TO PERSONS, OBSERVE THE FOLLOWING:

1. Use this unit only in the manner intended by the manufacturer. If you have questions, contact the manufacturer at the address or telephone number listed in the warranty.
2. Before servicing or cleaning unit, switch power off at service panel and lock the service disconnecting means to prevent power from being switched on accidentally. When the service disconnecting means cannot be locked, securely fasten a prominent warning device, such as a tag, to the service panel.
3. Installation work and electrical wiring must be done by a qualified person(s) in accordance with all applicable codes and standards, including fire-rated construction codes and standards.
4. Sufficient air is needed for proper combustion and exhausting of gases through the flue (chimney) of fuel burning equipment to prevent backdrafting. Follow the heating equipment manufacturer's guideline and safety standards such as those published by the National Fire Protection Association (NFPA), and the American Society of Heating, Refrigeration and Air Conditioning Engineers (ASHRAE), and the local code authorities.
5. When cutting or drilling into wall or ceiling, do not damage electrical wiring and other hidden utilities.
6. To reduce the risk of fire or electric shock, do not use this range hood with an additional speed control device.
7. Ducted fans must always be vented to the outdoors.
8. To reduce the risk of fire, use only metal ductwork.
9. Use with approved cord-connection kit only.
10. This unit must be grounded.

TO REDUCE THE RISK OF A RANGE TOP GREASE FIRE:

1. Never leave surface units unattended at high settings. Boilovers cause smoking and greasy spillovers that may ignite. Heat oils slowly on low or medium settings.
2. Always turn hood ON when cooking at high heat or when cooking flaming foods.
3. Clean ventilating fans frequently. Grease should not be allowed to accumulate on fan or filter.
4. Use proper pan size. Always use cookware appropriate for the size of the surface element.

TO REDUCE THE RISK OF INJURY TO PERSONS IN THE EVENT OF A RANGE TOP GREASE FIRE, OBSERVE THE FOLLOWING:*

1. **SMOTHER FLAMES** with a close-fitting lid, cookie sheet, or metal tray, then turn off the burner. **BE CAREFUL TO PREVENT BURNS.** If the flames do not go out immediately, **EVACUATE AND CALL THE FIRE DEPARTMENT.**
2. **NEVER PICK UP A FLAMING PAN** — You may be burned.
3. **DO NOT USE WATER**, including wet dishcloths or towels - violent steam explosion will result.
4. Use an extinguisher **ONLY** if:
 - A. You know you have a Class ABC extinguisher and you already know how to operate it.
 - B. The fire is small and contained in the area where it started.
 - C. The fire department is being called.
 - D. You can fight the fire with your back to an exit.

* Based on "Kitchen Fire Safety Tips" published by NFPA.

CAUTION



1. For general ventilating use only. Do not use to exhaust hazardous or explosive materials and vapors.
2. To avoid motor bearing damage and noisy and/or unbalanced impellers, keep drywall spray, construction dust, etc. off power unit.
3. For best capture of cooking impurities, your range hood should be mounted so that the top of the hood is 24-30" above the cooking surface.
4. Please read specification label on product for further information and requirements.

Installer: Leave this manual with the homeowner.

Homeowner: Operating and Cleaning information on page 5.

NOTE

If hood is to be installed Non-Ducted:
Purchase a set of (2) non-ducted filters from your local distributor or retailer and attach them to the aluminum mesh filters.

TABLE OF CONTENTS

This manual is divided into sections as follows:

"PREPARE HOOD LOCATION"

Run ductwork from roof or wall cap, and electrical wiring from service panel - to installation location

"PREPARE THE HOOD"

Get your hood ready for installation

"CONNECT WIRING"

Make electrical wiring connections to hood

"INSTALL HOOD"

Secure hood to cabinet and ductwork - install bulbs and filters

"OPERATION"

How to use the hood controls

"CLEANING"

Keep your hood in top working condition

"SERVICE PARTS"

Part numbers and exploded view of hood components

"WARRANTY"

One-year limited warranty and how to contact us

PREPARE HOOD LOCATION

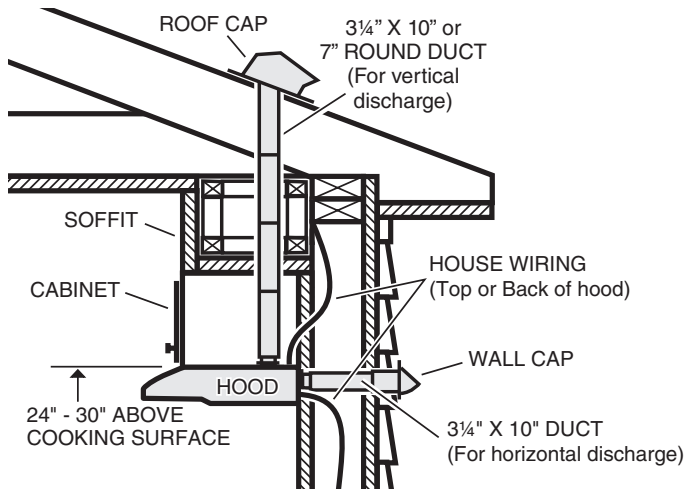

- 1 Determine whether hood will discharge vertically (3/4" x 10" or 7" Round), horizontally (3/4" x 10" only) or non-ducted. For vertical or horizontal discharge, run ductwork between the hood location and a roof cap or wall cap. For best results, use a minimum number of transitions and elbows.
- 2 Use diagrams, below, for proper placement of ductwork and electrical cutout in cabinet or wall. For a non-ducted installation, DO NOT cut a duct access hole.

PREPARE HOOD LOCATION

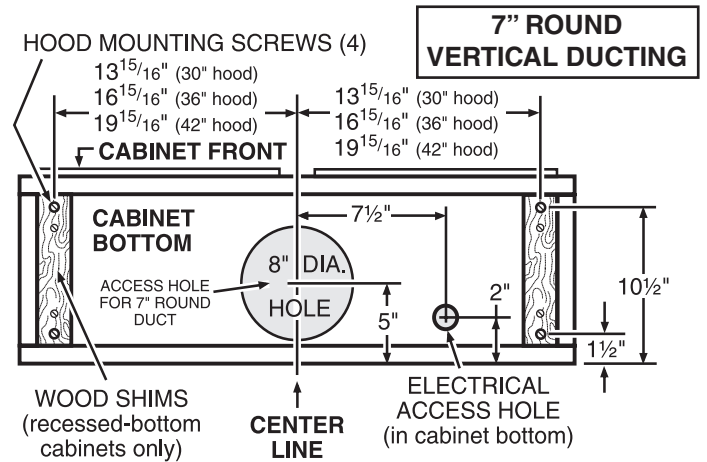

- 3 Run house wiring between service panel and hood location.

PREPARE THE HOOD

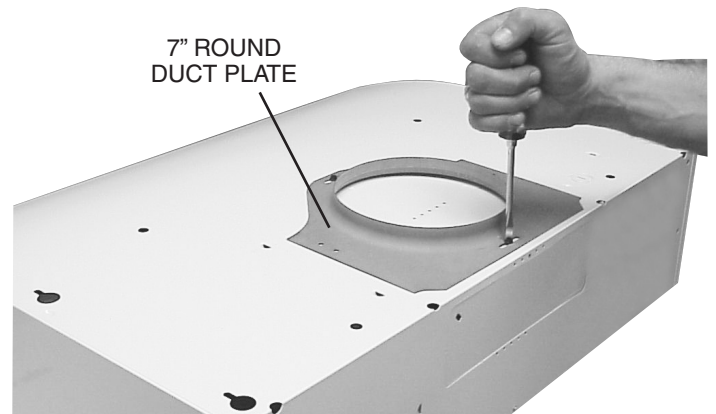
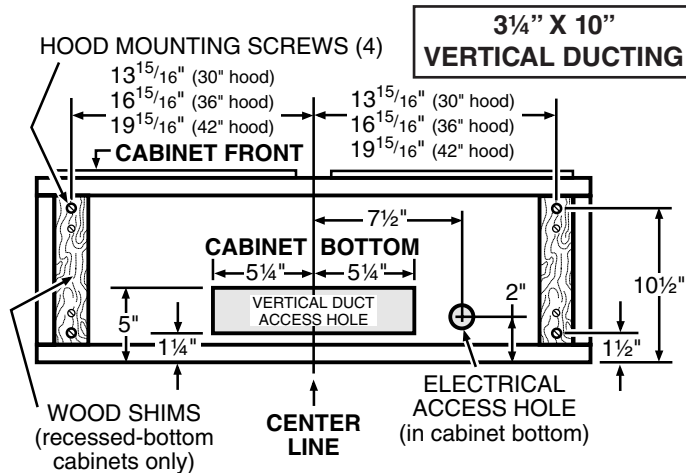

- 1 Remove 7" Round Duct Plate from top of hood. Set duct plate aside - with mounting screws.

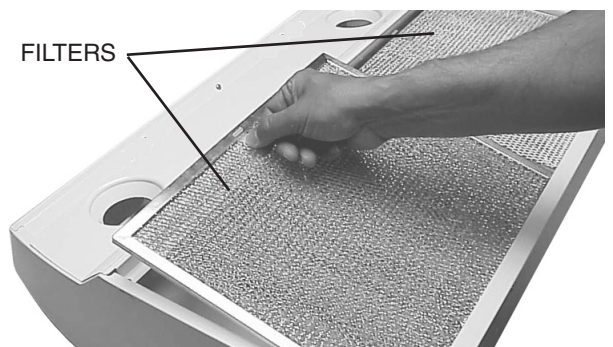
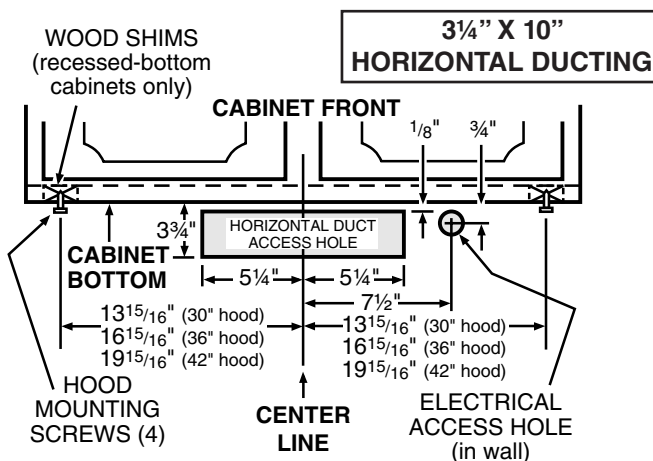

- 2 Remove tape holding Filters in place. Pull down on filter tabs and lift filters out. Set filters aside.

PREPARE THE HOOD

- 3** Remove **Damper/Duct Connector** from inside the hood. Set connector aside - with mounting screws and parts bag.

DAMPER/DUCT CONNECTOR

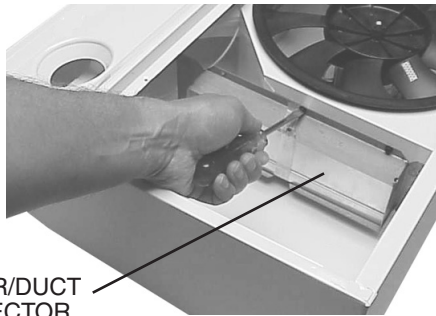

- 4** Remove **Wiring Cover** from inside the hood. Set cover and mounting screw aside.

WIRING COVER



- 5** Remove either top or back wiring knockout and install approved **Electrical Cable Clamp**.

ELECTRICAL CABLE CLAMP

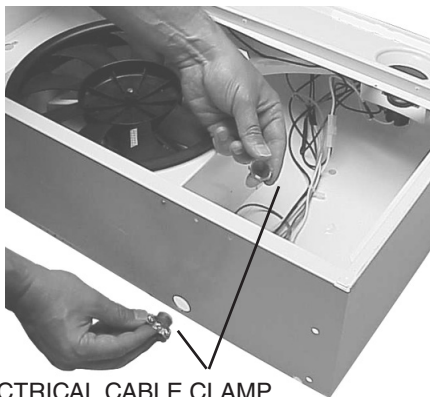

Non-Ducted Installation - Skip to "Connect Wiring" section.

The following Steps (6 thru 13) are for DUCTED INSTALLATION ONLY.

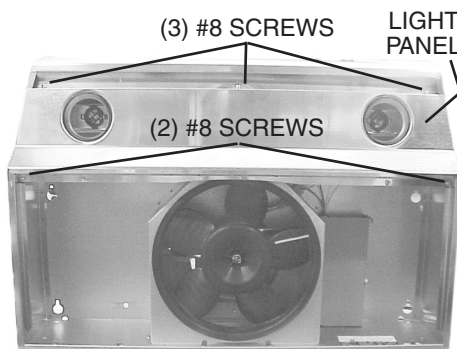

- 6** Remove **Light Panel** - held in place with (3) #8 screws and (2) #8 screws. Disconnect light assembly wire harness (white connector).

PREPARE THE HOOD

- 7** Remove **Air Chute** - held in place with one (1) screw.

NOTE: Be careful not to disconnect any wires.

AIR CHUTE

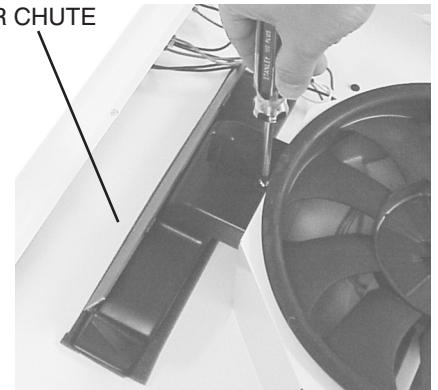

- 8** Remove **Baffle** from air chute.

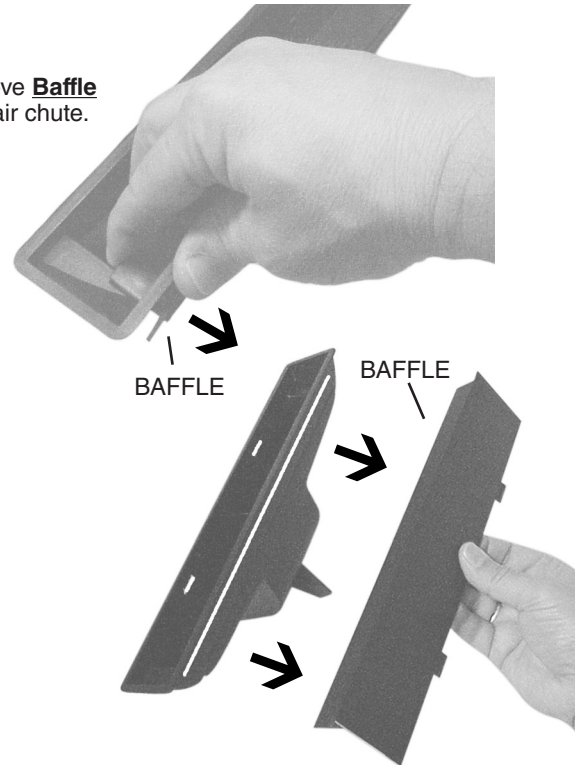

- 9** Rotate baffle. Re-insert baffle into air chute (as shown) so that baffle **tabs** fit all the way into **slots** in air chute. An audible "click" will be heard when fully installed. This will close off the air flow through the non-ducted slots on top of hood.

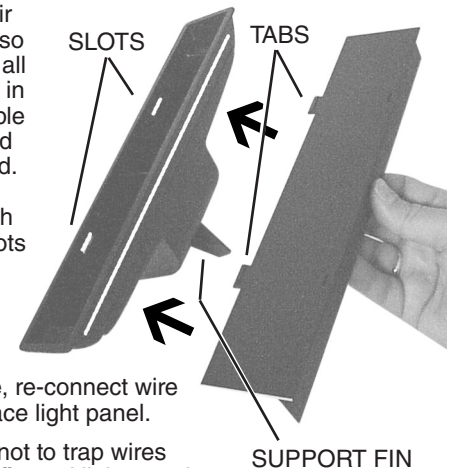

- 10** Re-install air chute, re-connect wire harness, and replace light panel.

NOTE: Be careful not to trap wires between **support fin** and light panel.

PREPARE THE HOOD

TOP RECTANGULAR
DUCT KNOCKOUT
(Remove for 3¼" x 10"
Vertical & for 7" Round
Discharge)

SEMI-CIRCULAR
DUCT KNOCKOUT
(Remove for 7" Round
Discharge)

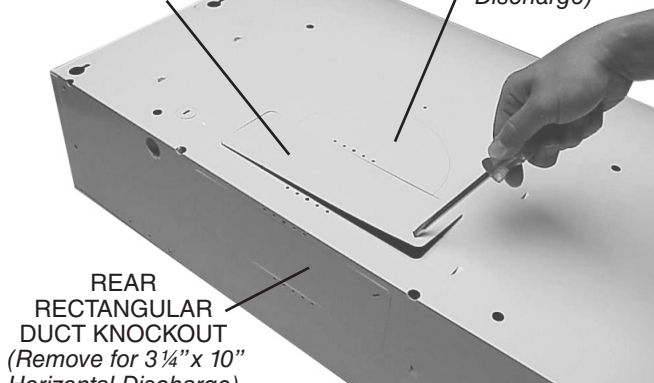

REAR
RECTANGULAR
DUCT KNOCKOUT
(Remove for 3¼" x 10"
Horizontal Discharge)

- 11** Remove appropriate **Duct Knockout(s)** from top or back of hood.

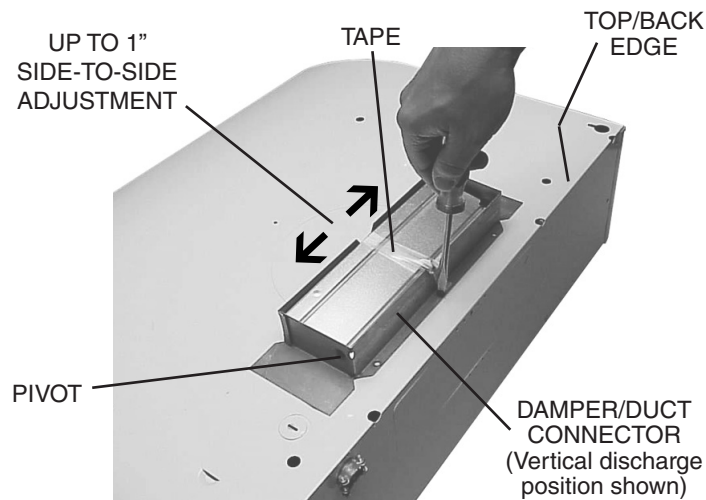

- 12** 3¼" x 10" Ducted Discharge Only: Attach **Damper/Duct Connector** over knockout opening. Make sure damper **Pivot** is nearest to **Top/Back Edge** of hood. Remove **Tape** from damper flap.

- 13** 7" Round Ducted Discharge Only: Re-install **7" Round Duct Plate** removed in Step #1 under "PREPARE THE HOOD" section. Install a 7" round damper (purchase separately). Damper flap must open freely in direction of air flow (away from range hood).

NOTE To accommodate off-center ductwork, the Damper/Duct Connector can be installed up to 1-inch on either side of hood center or the 7" Round Duct Plate can be installed up to ½" on either side of hood center. In extreme off-center installations, one end of the duct connector may need to be trimmed to clear the electrical cable clamp.

CONNECT WIRING



WARNING: To reduce the risk of electric shock, make sure power is switched off at the service panel. Lock or tag service panel to prevent power from being switched on accidentally.

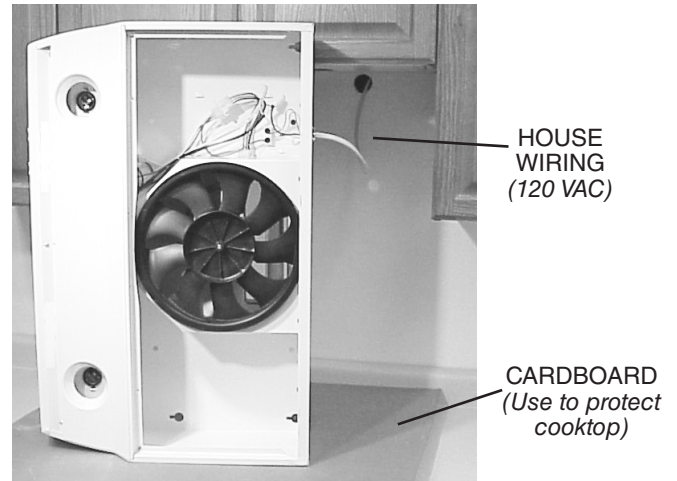

- 1** Connect **House Wiring** (120 VAC) to hood. Use a piece of **Cardboard** to protect the cooktop, if necessary.

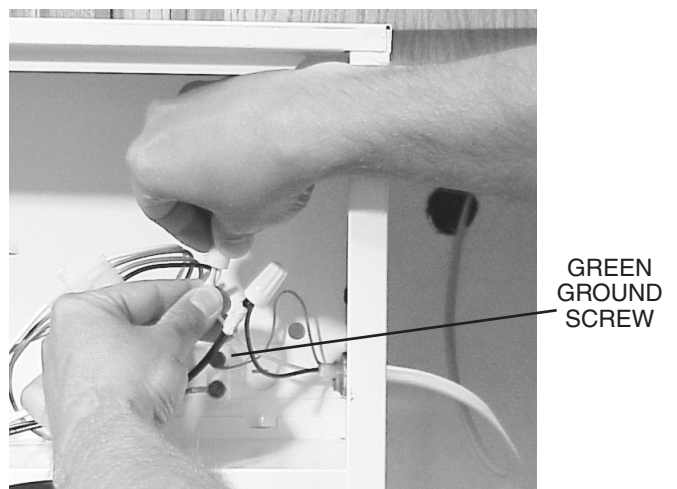

- 2** Connect house black to hood black wire, house white to hood white wire, and house ground under **Green Ground Screw**. Securely tighten cable clamp onto house wiring.

- 3** Replace wiring cover.

INSTALL HOOD

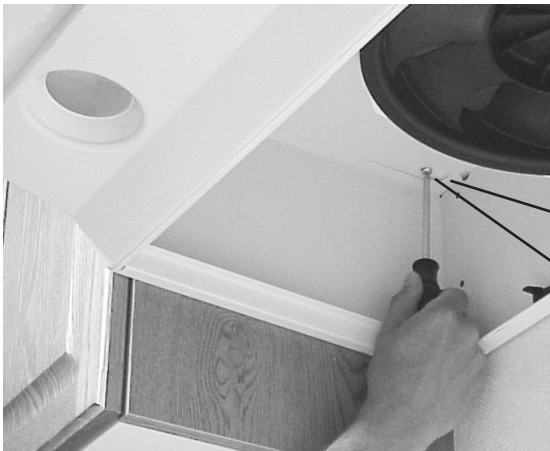

KEYHOLE
(4)
MOUNTING
SCREW
(4)

- 1 Hang hood from (4) **Mounting Screws** (from parts bag). Slide hood towards wall until mounting screws are engaged in narrow end of (4) **Keyholes**. Tighten mounting screws securely.

CAUTION DO NOT PUSH ON FAN BLADE. Pushing on the blade may cause it to interfere with other hood parts.



DUCT
TAPE

- 2 Connect ductwork to hood. Use **Duct Tape** to make joints secure and air tight.

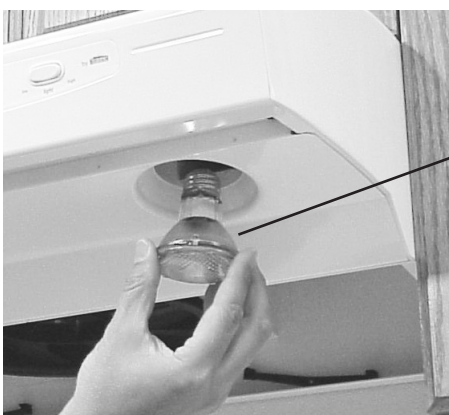

PAR20,
50W MAX.
HALOGEN
BULB (2)
- or -
R16,
40W MAX.
INCANDESCENT
BULB (2)

- 3 Install (2) PAR20, 50 W Maximum **Halogen Bulbs** or (2) R16, 40 W Maximum **Incandescent Bulbs**. Purchase bulbs separately.

CAUTION: Bulbs may be hot! Refer to bulb packaging for further information.

- 4 Replace filters and make sure fan blade turns freely. Turn on power at service panel, and test for proper operation.

NON-DUCTED FILTERS

If hood is to be installed Non-Ducted:
Purchase a set of (2) non-ducted filters from your local distributor or retailer and attach them to the aluminum mesh filters.

OPERATION

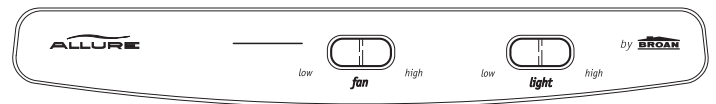

Fan: The 3-position rocker switch (on the left) controls the fan. The left position is low speed, center position is off, and right position is high speed. An indicator light shows that the fan is on.

Light: The 3-position rocker switch (on the right) controls the lights. The left position is low light intensity, center position is off, and right position is high light intensity.

CLEANING

WARNING: To reduce the risk of electric shock, disconnect from power supply before cleaning.

Aluminum mesh filters: Clean frequently using hot water and a mild detergent. Filters are dishwasher safe.

Charcoal filters: Clean filter surfaces frequently with a damp cloth and a mild detergent. DO NOT immerse filters in water or put in dishwasher. The special "Clean Sense" feature indicates when the filter is to be replaced. The blue and yellow strips will blend to green when it is time to change the filter. The "Clean Sense" feature works best when facing toward the cooking surface.

To clean hood: Remove filters. Use a damp cloth and a mild detergent to wipe all grease-laden surfaces. Use care when cleaning fan blade - it must not become bent or misaligned. DO NOT ALLOW WATER TO ENTER MOTOR. Make sure all surfaces are completely dry before re-installing filters and restoring power.

Motor is permanently lubricated. Do not oil or disassemble motor.

SERVICE PARTS

KEY NO.	PART NO.	DESCRIPTION
1	R680508	7" Round Duct Plate (includes hardware)
2	R740013	Damper/Duct Connector (includes hardware)
3	R602017	Screw, #8-18 x 1/4 Hex* (2 in package)
4	R561115	Rocker Switch, Almond (2 in package)
	R561116	Rocker Switch, White (2 in package)
	R561117	Rocker Switch, Black (2 in package)
	R561119	Rocker Switch, Biscuit (2 in package)
5	R627497	Nameplate, White
	R627498	Nameplate, Almond
	R627499	Nameplate, Stainless
	R627527	Nameplate, Biscuit
	R627575	Nameplate, Black
6	R607657	Lens
7	R602534	Screw, 8-18 x 3/8* (2 in package)
8	R602533	Ground Screw (2 req.)
9	R680504	Wiring Cover (includes hardware)
10	*	Rivet, Pop .125 dia.
11	R169016	Filter Spring Kit
12	R169002	Motor Mounting Screw (3 each part)
13	R99080535	Motor (includes Motor Mounting Kit)
14	R401647	Air Chute Assembly (includes Key No. 15 & hardware)
15	R401646	Baffle
16	R531075	Fan Blade (Includes hairpin clip)
**	R99420635	Hairpin Clip
17	99010299	Filter Kit, for 30" Hood (2 per bag)
	99010300	Filter Kit, for 36" Hood (2 per bag)
	99010301	Filter Kit, for 42" Hood (2 per bag)
18	R111630	Lamp Socket Harness
19	R7201731	Light Panel, White, for 30" Hood
	R7201751	Light Panel, White, for 36" Hood
	R7201771	Light Panel, White, for 42" Hood
	R7201732	Light Panel, Almond, for 30" Hood
	R7201752	Light Panel, Almond, for 36" Hood
	R7201772	Light Panel, Almond, for 42" Hood
	R7201734	Light Panel, Black, for 30" Hood
	R7201754	Light Panel, Black, for 36" Hood
	R7201774	Light Panel, Black, for 42" Hood
	R720174	Light Panel, Stainless, for 30" Hood
	R720176	Light Panel, Stainless, for 36" Hood
	R720178	Light Panel, Stainless, for 42" Hood
	R7201735	Light Panel, Biscuit, for 30" Hood
	R7201755	Light Panel, Biscuit, for 36" Hood
	R7201775	Light Panel, Biscuit, for 42" Hood
20	R169004	Indicator Light (includes 2 wire nuts and lens)
**	R169010	Light Diode Assembly (includes wire nut)
**	R111626	Wire Harness
**	99010308	Non-Ducted Filter Kit, 30" (2 per bag)
**	99010309	Non-Ducted Filter Kit, 36" (2 per bag)
**	99010310	Non-Ducted Filter Kit, 42" (2 per bag)

Order replacement parts by PART NO. - not by KEY NO.

* Standard hardware - may be purchased locally.

** Not illustrated.

Replacement parts
can now be ordered
on our website.
Please visit us at
www.Broan.com

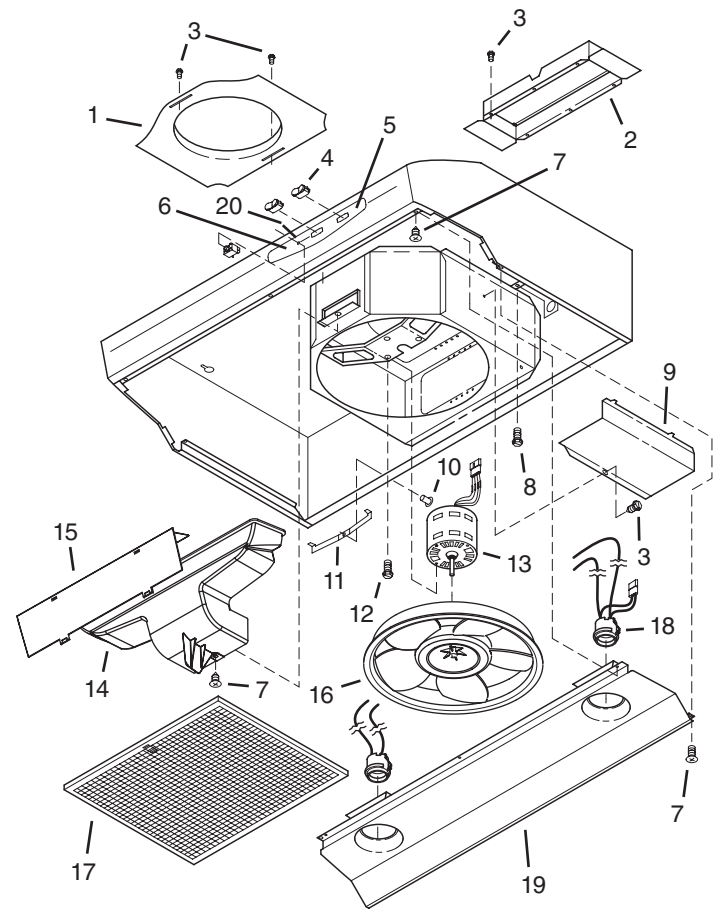

WARRANTY

BROAN-NUTONE ONE YEAR LIMITED WARRANTY

Broan-NuTone warrants to the original consumer purchaser of its products that such products will be free from defects in materials or workmanship for a period of one year from the date of original purchase. THERE ARE NO OTHER WARRANTIES, EXPRESS OR IMPLIED, INCLUDING, BUT NOT LIMITED TO, IMPLIED WARRANTIES OF MERCHANTABILITY OR FITNESS FOR A PARTICULAR PURPOSE.

During this one-year period, Broan-NuTone will, at its option, repair or replace, without charge, any product or part which is found to be defective under normal use and service. THIS WARRANTY DOES NOT EXTEND TO FLUORESCENT LAMP STARTERS AND TUBES. This warranty does not cover (a) normal maintenance and service or (b) any products or parts which have been subject to misuse, negligence, accident, improper maintenance or repair (other than by Broan-NuTone), faulty installation or installation contrary to recommended installation instructions.

The duration of an implied warranty is limited to the one-year period as specified for the express warranty. Some states do not allow limitation on how long an implied warranty lasts, so the above limitation may not apply to you.

BROAN-NUTONE'S OBLIGATION TO REPAIR OR REPLACE, AT BROAN-NUTONE'S OPTION, SHALL BE THE PURCHASER'S SOLE AND EXCLUSIVE REMEDY UNDER THIS WARRANTY. BROAN-NUTONE SHALL NOT BE LIABLE FOR INCIDENTAL, CONSEQUENTIAL OR SPECIAL DAMAGES ARISING OUT OF OR IN CONNECTION WITH PRODUCT USE OR PERFORMANCE. Some states do not allow the exclusion or limitation of incidental or consequential damages, so the above limitation may not apply to you.

This warranty gives you specific legal rights, and you may also have other rights, which vary from state to state. This warranty supersedes all prior warranties.

To qualify for warranty service, you must (a) notify Broan-NuTone at the address or telephone number below, (b) give the model number and part identification and (c) describe the nature of any defect in the product or part. At the time of requesting warranty service, you must present evidence of the original purchase date.

Broan-NuTone LLC, 926 West State Street, Hartford, WI 53027 (1-800-637-1453)