

This Owner's Manual is provided and hosted by [Appliance Factory Parts](#).



SEA BREEZE PAS12 Owner's Manual

[Shop genuine replacement parts for SEA BREEZE
PAS12](#)



[Find Your SEA BREEZE Air Conditioner Parts - Select From 23 Models](#)

----- Manual continues below -----



READ THIS MANUAL THOROUGHLY

MOBILE AIR CONDITIONER

Models:

PAS12 12,000 Btu Cooling Only

PAHS127 12,000 Btu Cooling, 7,000 Btu Heating



CONTENTS

Introduction	3
Theory of Operation	3
Technical Specifications	4
Structure	5
Operation	6
Accessories Installation	20
Maintenance	23
Trouble Shooting	24
Safety Caution and Special Guideline	25
Warranty Statement	26

Introduction

Mobile Air Conditioner

This Mobile Air Conditioner is a small size appliance which can control the temperature and humidity in a room. Its flexible characteristics make it easy to use on different occasions and in different rooms. It also has multiple functions including cooling, heating, dehumidifying, and fan ventilation. This unit is designed especially for the home, office, spot cooling/heating, etc. it has a compact design compared to others with the same cooling capacity. Power consumption and noise are especially low.

ATTENTION

Before you use your Mobile Air Conditioner, please read this manual carefully. This Instruction Manual is for reference only, and does not constitute a contract. We reserve the right to make technical changes without prior notice.

Theory of Operation

The gas has a heat exchange with air in a room and changes into liquid, then passes to a capillary tube to lower temperature and pressure and enters into the evaporator. With heat exchange, refrigerant absorbs heat to lower the temperature. The evaporator is lower than the dew point temperature of air in the room; water vapor will condense on the outside surface of the evaporator and drop down into the drain tank. This cycle lowers the relative humidity in the room and attains the goal of dehumidification.

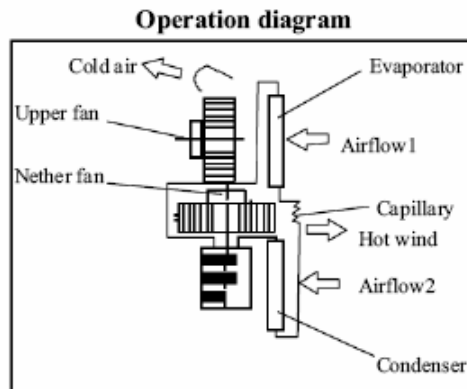

Technical Specifications

Model	PAS12	PAHS127
EER Rating Btu/w	8.8	8.8
Cooling Capacity	12,000BTU	12,000BTU
Heating Capacity	N/A	7,000BTU
Rated Voltage	115Vac	115Vac
Rated Frequency	60Hz	60Hz
Rated Current	14.6Amps	14.6Amps
Power Input	1200W	1200W cooling/1500W heating
Rated Input	1500W	1500W
Cycling Airflow	174 CFM	174CFM
Refrigerant/R22	1.21LBS	1.21LBS
Noise Max.	62db(A)	62db(A)
Net WT/Gross WT	99/105.6LBS	99/105.6LBS
Unit Dimensions	17.7x14.5 x33.7	17.7x14.5 x33.7
Dehumidifying Volume	13.9 Gallons/day	13.9 Gallons/day
BRK Size	20A	20A

NOTE:

The cooling capacity indicated is measured at ambient temperature DB 86°F, WB 77.9°F (inside and outside equal).

The heating capacity indicated is measured at ambient temperature DB 68°F, WB 53.6°F (inside and outside equal).

The Noise level is taken at a distance of 39" from the front part of the appliance in cooling mode.

The power consumption of the fan is measured with the fan at maximum speed.

The specifications indicated only serve as a reference. Please refer to the information contained on the appliance data plate.

STRUCTURE

Front

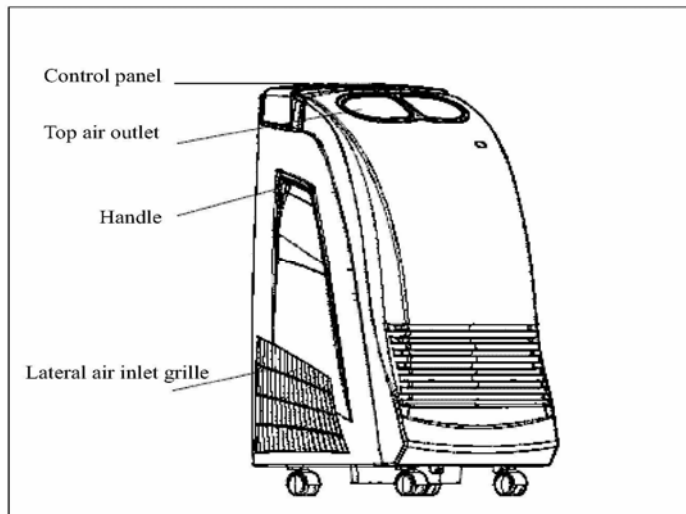

Back

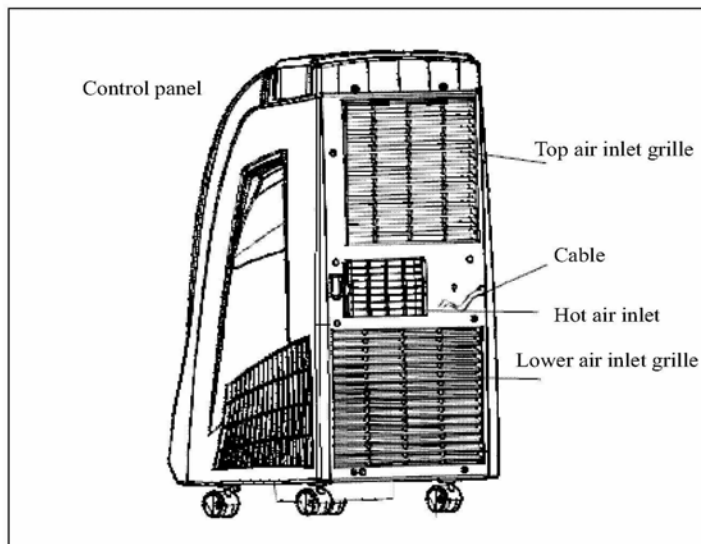

OPERATION

ATTENTION:

DEHUMIDIFYING AND COOLING OPERATION

The operating ranges for cooling and dehumidifying operation is 62°F - 95°F.

LOCATION:

Put the mobile air conditioner at an open place where the air outlets cannot be covered up. Place the unit no less than 20 inches away from a wall or other obstacle.

POWER SUPPLY:

Before connecting the air conditioner to the power supply, please check:

The power supply is rated voltage 115V +- 6%.

The power supply line is PROPERLY grounded and sized for a pickup current of 20A, so as to avoid voltage drops when starting the air conditioner.

The unit is connected to a 16Amp socket by a 16Amp plug. The wire size should be 10AWG.

This room air conditioner is equipped with a power supply cord required by UL. This power supply cord contains state-of-the-art electronics that sense leakage current. If the cord is crushed, the electronics detect leakage current and power will be disconnected in a fraction of a second. If the power supply cord of the unit is damaged, please replace it with a special power supply cord by a qualified electrician.

NOTE: Your unit's device may differ from the ones shown.

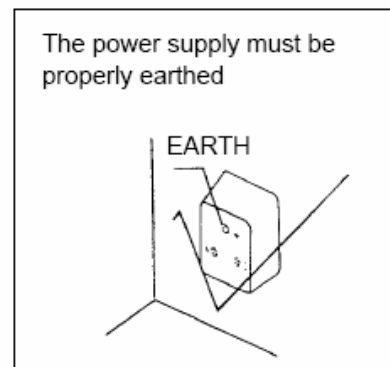
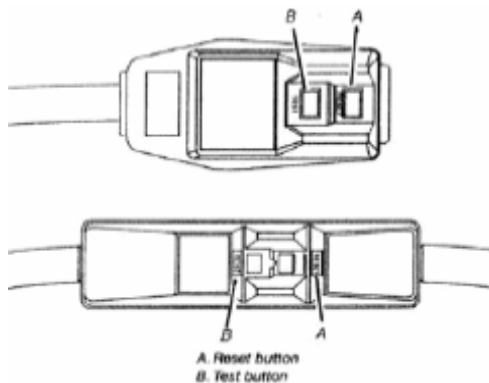

OPERATION

In order to prevent power fluctuations during the start of the compressor, the following installation conditions apply:

1. The power source must be capable of handling 16A continuous.
2. Avoid connecting other equipment to this power source.
3. For power details of the air conditioner, refer to the rating plate of the product.

OPERATION

CONTROL PANEL AND LCD

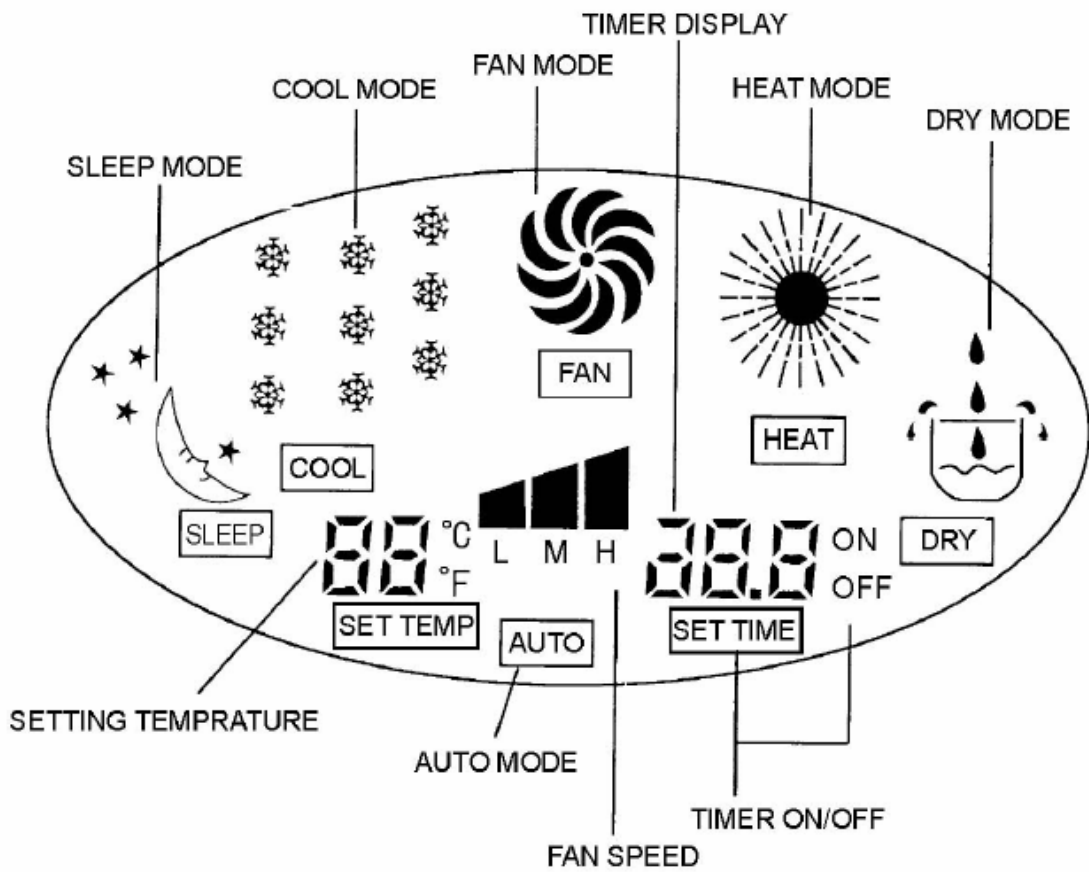
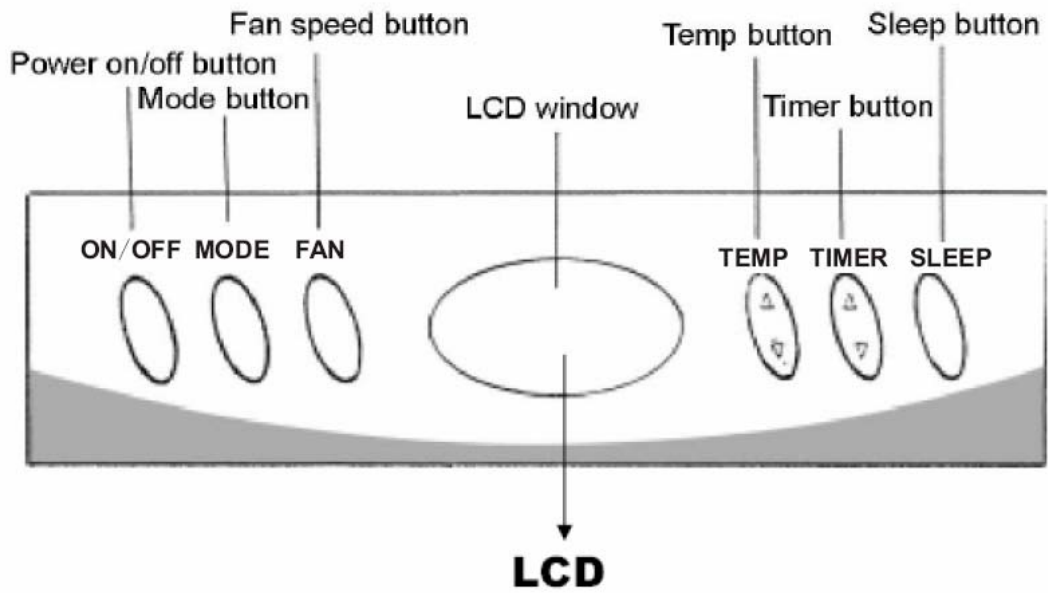

OPERATION

CONTROL PANEL – BUTTONS

TURN THE AIR CONDITIONER ON:

Press the power ON/OFF button. This will turn the unit on.

MODE BUTTON “MODE”: There are 5 running modes to choose from:

FAN ⇒ COOL ⇒ DRY ⇒ HEAT ⇒ AUTO

NOTE: Only Model PAHS127 has the heat function.

FAN SPEED BUTTON:

There are three fan speeds in all modes of operation. Push the “FAN” button to change the fan speed. It will change in the sequence:

HIGH ⇒ MEDIUM ⇒ LOW.

TEMPERATURE SETTING BUTTON “TEMP”:

As soon as the air conditioner has been switched on, the display on the control panel will show the temperature set point.

Use keys “▲” or “▼” to increase or decrease the temperature setting. It is good practice to set the temperature before selecting the operational mode.

USE THE “TIMER” BUTTON TO PROGRAM THE AIR CONDITIONER:

Use the “▲” or “▼” buttons to change the time for the air conditioner to turn on or off. When the unit is running, set the unit stop time; and when the unit is off (but with power connected), set the start time.

SLEEP BUTTON:

When the unit is running press the “SLEEP” button to activate the sleep mode.

Press once more to deactivate the sleep mode. This key does not function under the “AUTO” mode.

OPERATION

COOLING OPERATION

Ensure that the drain tank is properly placed in the unit.

Install the exhaust duct properly (see air exhaust duct page).

During the cooling operation, always place the duct through an open window, or outside of the area being cooled.

Repeatedly press the “MODE” button to choose the cooling mode.

The LCD Window will indicate “COOL”.

To set the temperature, press the “▲” or “▼” temperature buttons to set the room temperature between 61° F and 86° F.

Press the “FAN” button to select the fan speed, HIGH ⇒ MEDIUM ⇒ LOW

Note: In order to improve the cooling efficiency:

Ensure that the unit is not exposed to direct sunlight.

Do not place the unit near a heat source.

DEHUMIDIFYING OPERATION

Keep windows and doors closed to aid in effectively dehumidifying the room.

Repeatedly press the “MODE” button to choose the dehumidifying mode.

The LCD Window will display “DRY”. The fan speed is not adjustable in the dehumidifying mode.

When used as a dehumidifier only, do not use the air exhaust duct.

FAN SPEED

Press the “MODE” button to select the fan mode.

The LCD Window will display “FAN”.

Press “FAN” button to choose the fan speed: HIGH ⇒ MEDIUM ⇒ LOW.

HEATING OPERATION (ONLY FOR MODEL PAHS127)

Press the “MODE” button to select the heating mode.

The LCD Window will display “HEAT”.

Press “FAN” to choose the fan speed: HIGH ⇒ MEDIUM ⇒ LOW.

Note: During heating, only the heat element and blower fan is activated.

OPERATION

WATER DRAINAGE

When operating the air conditioner in cooling or dehumidifying mode under normal conditions, the condensation water is automatically evaporated from an internal drip pan out through the exhaust duct. Under extremely high humidity conditions, the water in the drip pan may reach a level that triggers a shut-off mechanism. The compressor and fan will turn off and the water must be drained via one of the following two methods.

CONTINUOUS DRAINAGE

When the unit is operating on continuous drainage mode, excess condensation in the drip pan is discharged by gravity through the drainage tube to either an external tank (not provided) or to a condensation water pump device (Optional Item). When the unit is operating on continuous drainage mode, it can operate continuously regardless of humidity level.

Installation Steps:

Remove the plug from the drainage spout.

Connect the drainage tubing to the drainage spout.

Place the other end of the drainage tube into either an external water tank or the inlet side of a condensation water pump.

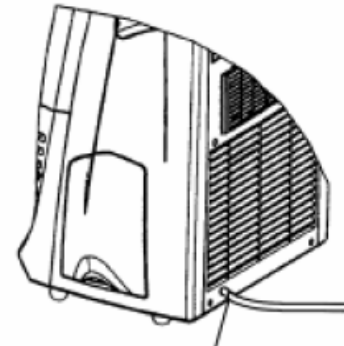

Continuous Drainage Spout

MANUAL DRAINAGE

When the unit is operating in manual drainage mode, excess condensation in the drip pan will rise until it reaches a predetermined level, at which time the air conditioner will signal a warning (E4 on LCD) and shut off. To drain the excess condensation, turn off the conditioner, remove the drain plug and allow water to drip into an external pan or drainage tubing.

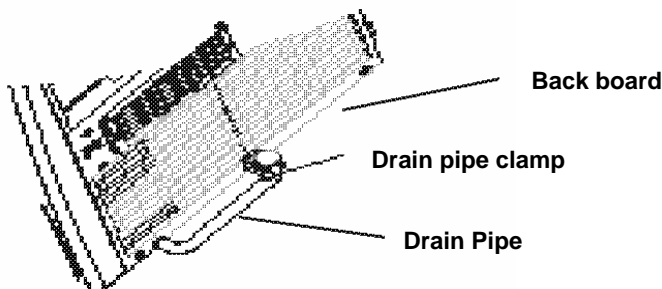

Warning: Do not operate the air conditioner without the drain plug unless the drainage tube is directed to an external drain or bucket. Dripping water may damage wood floor and carpet and may also cause injury if not properly contained.

OPERATION

REMOTE CONTROL DESCRIPTION

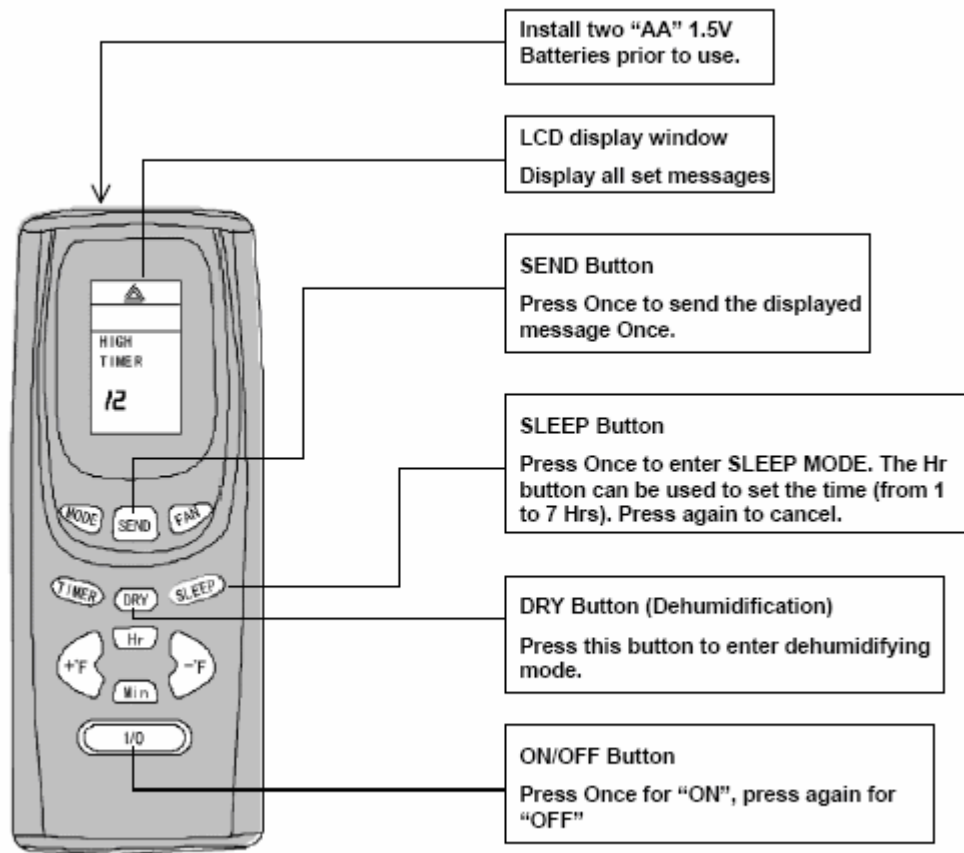

NOTE:

Please point the remote control at the signal receiver on the unit panel.

The information displayed can be transmitted at the mode AUTO, ON/OFF, SLEEP, SWING, and TRANSMIT. The other buttons can only change the messages which should be transmitted within 15 seconds; otherwise the messages will be canceled.

OPERATION

MAIN BUTTONS AND FUNCTIONS

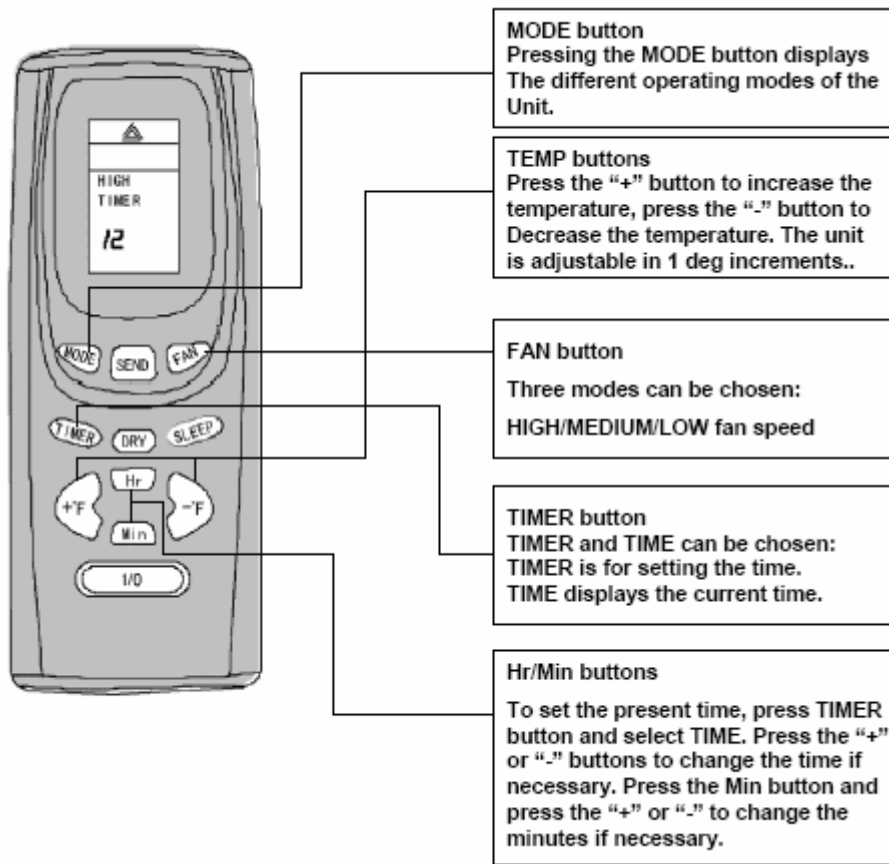

NOTE:

If the power fails, disconnect and reconnect the power cable.

Press the send button on the wireless remote control to restart the unit.

OPERATION

COOLING MODE

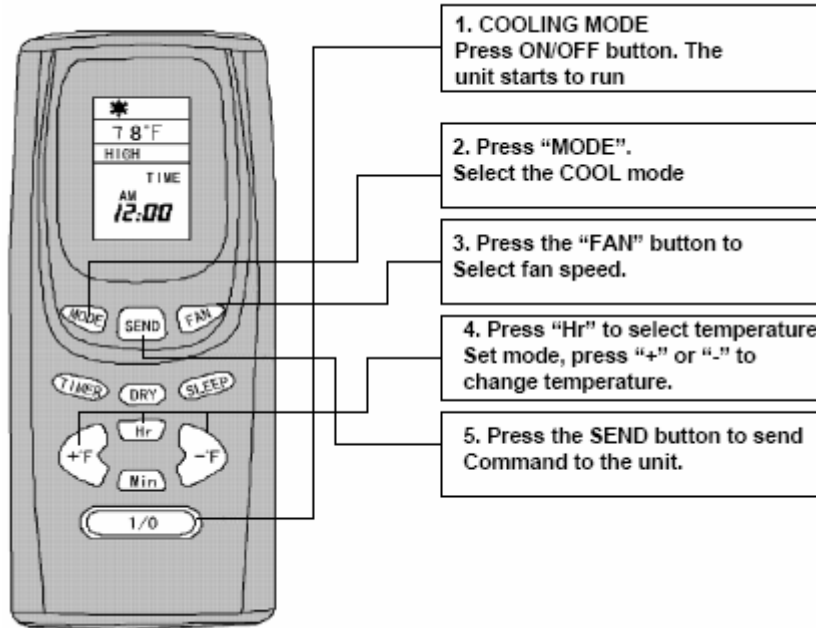

OPERATION

HEATING MODE (ONLY FOR MODEL PAHS127)

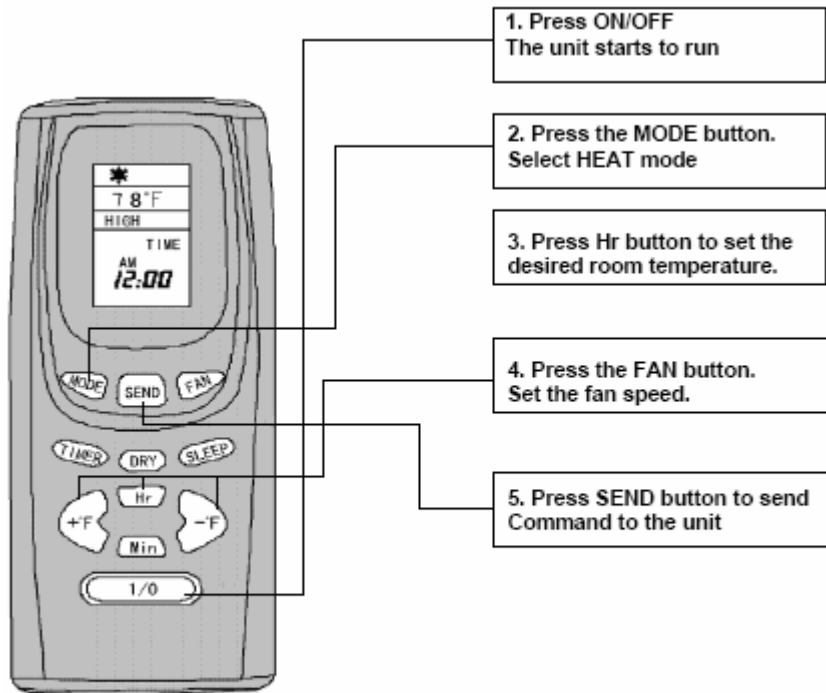

NOTE:

In the heat mode, only the heating element and the blower will operate.

OPERATION

DEHUMIDIFYING (DRY MODE)

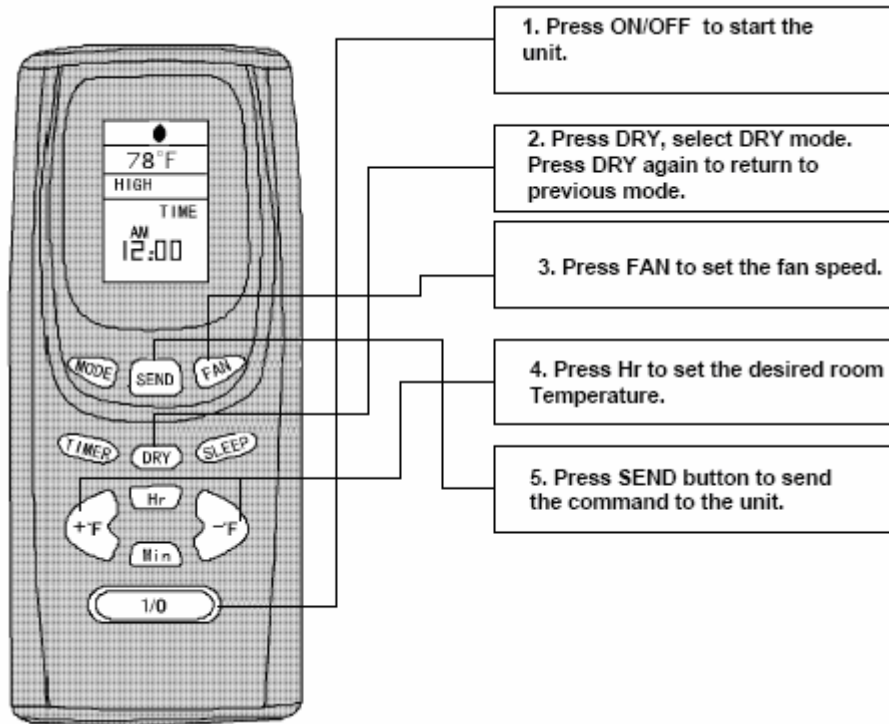

NOTE:

The compressor is running and the upper fan is running in low speed.

OPERATION

SLEEP MODE

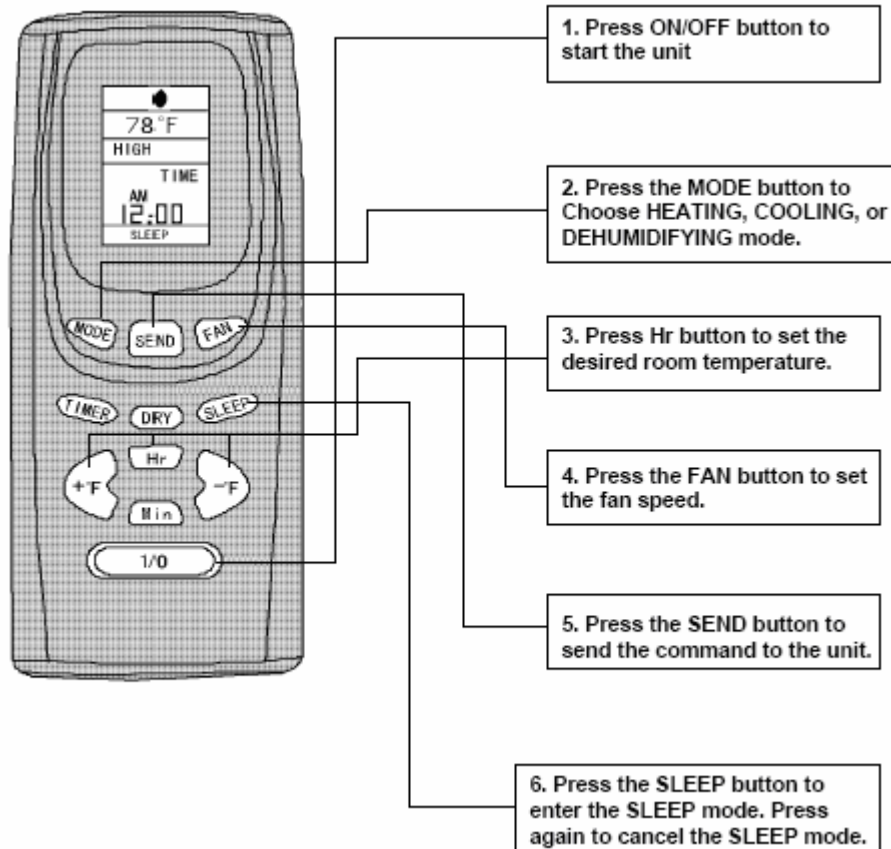

NOTE:

*To set the timer in the sleep mode, press the Hr button to select **TIMER** (displayed on LCD), press the + or – to select hours.*

In the sleep mode, the fan will go to low speed and the temperature will automatically adjust during the selected hours providing a comfort temperature for sleeping.

OPERATION

AUTO MODE

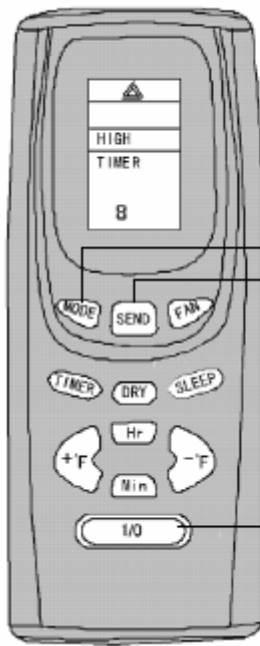

1. Press ON/OFF to start the unit.

2. Press MODE and select the AUTO Mode.
•The microprocessor controls the Compressor and fan motor on or off To keep the room comfortable.

3. Press the SEND button to send the command to the unit.

OPERATION

TIMER SETTING

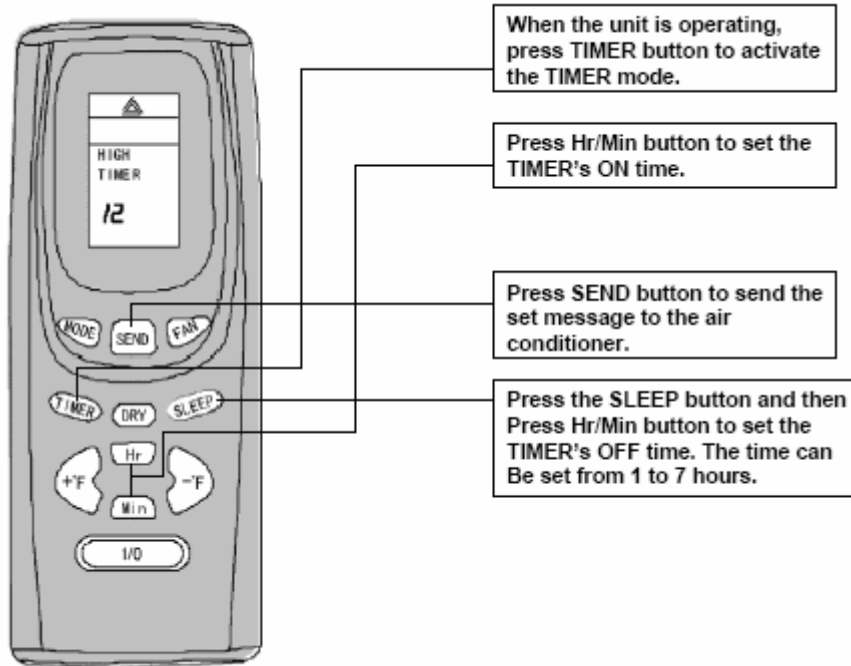

NOTE:

When Timer is set, the air conditioner will turn off immediately.

When the set time is reached, the unit will turn on again satisfying the room temperature.

During the timer setting, the timer can be reset by pressing TIMER and pressing the + or – button.

Pressing the SLEEP button cancels the timer mode, and pressing the TIMER button will cancel the sleep mode. Both can not be set simultaneously.

ACCESSORIES INSTALLATION

1. Caster Installation:

Note: The casters must be assembled before using the unit. Tilt the unit minimally to install the casters.

1. Open the accessory box and remove the casters (4).
2. Lift up the unit horizontally 4 to 8" above the ground.
3. Fit the caster into the opening in the base. (See diagrams).

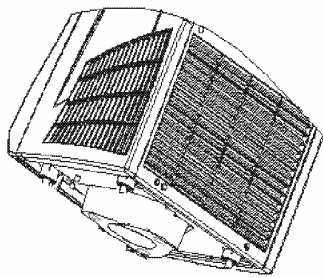

tilt angle

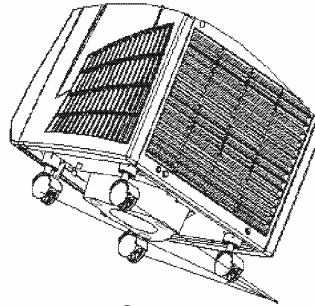

Casters

2. Assemble drain pipe

The unit must have the drain pipe assembled properly before using. If not, the water will drain outside the tank causing a potential hazard.

- 1) Remove the drain pipe, plug, and clamp from the packing box.
- 2) Remove the plug and attach the pipe securely to the water outlet on the base.
- 3) Attach the pipe to the clamp on the back board of the unit.

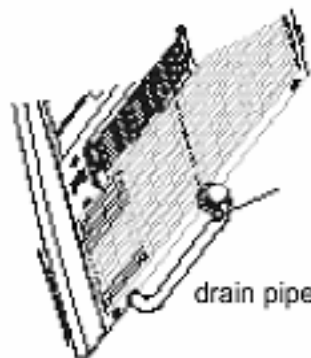
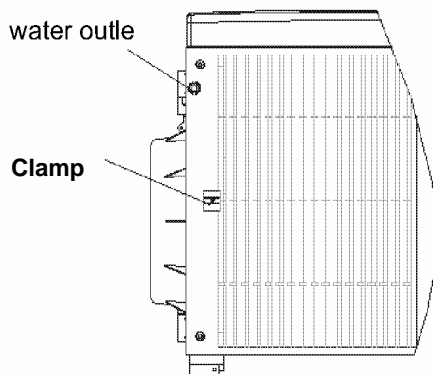

backside

Attach the pipe
To the clamp

3. Air exhaust duct

THE AIR EXHAUST DUCT MOUNTING METHOD CAUTION

Fix the square end of the exhaust duct to the exhaust terminal of the unit.
Put the other end (discharge) to the nearest window.

ATTENTION:

The length of the air exhaust must be between 19"-78"

When mounting, try to keep the air exhaust duct horizontal.

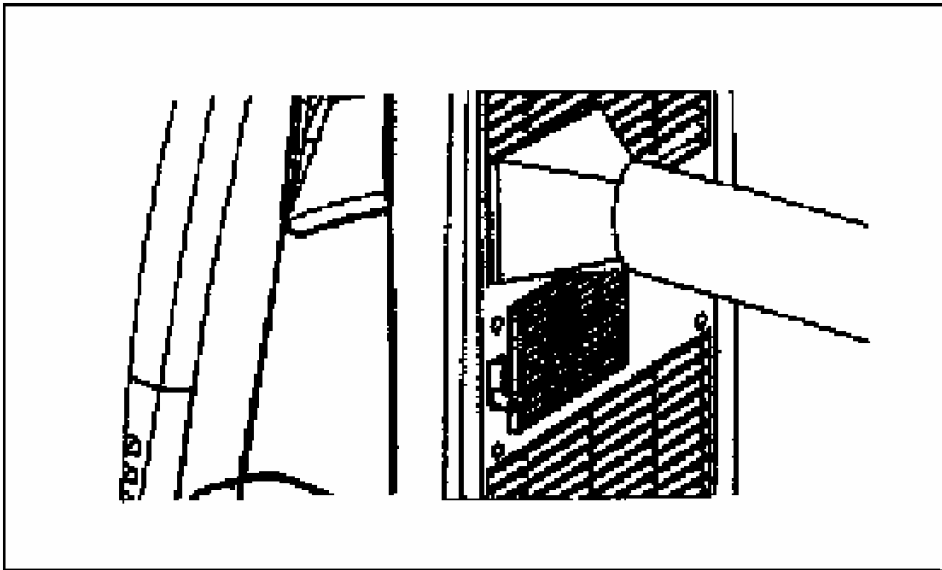

Correct mounting shown below. (If mounting in the wall, the height of the hole should be 15"-51" above the floor)

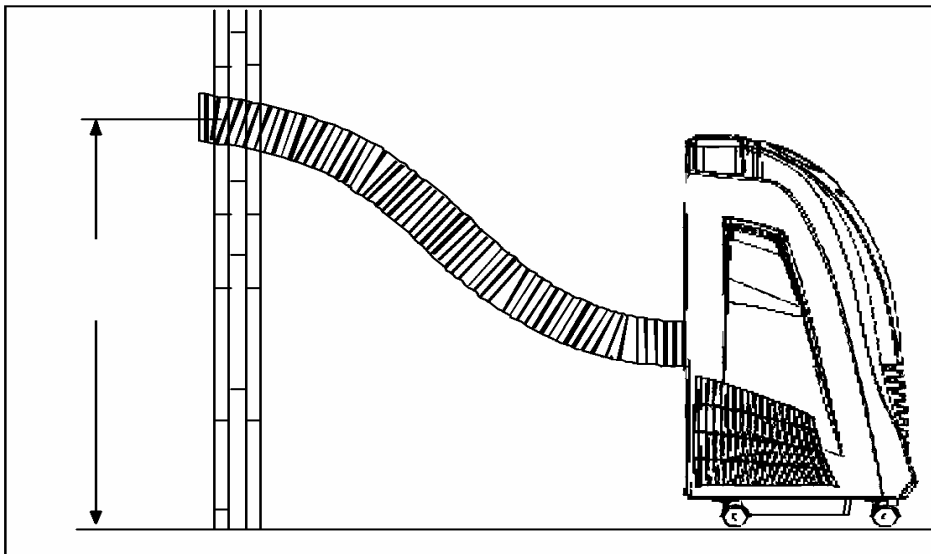

WINDOW KIT

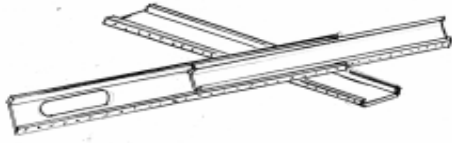

EXHAUST DUCT

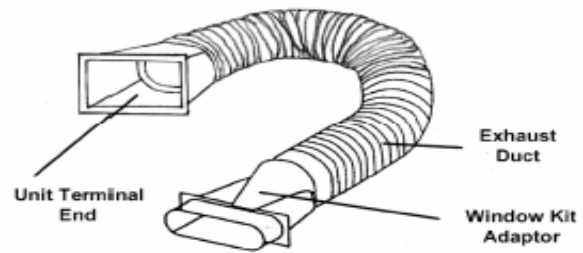

WINDOW KIT INSTALLATION

Open window or sliding door approximately 5 inches (13 cm). Adjust the length of the window kit to the same length of the window or sliding door. Use two or three panels if necessary and secure panels into place by fastening the 3/4" Phillips head screws into the pre-drilled panel holes.

Alternatively you may need to mark a single panel and cut it down to properly fit the window opening. The window kit (three panels) has a maximum length 81 inches.

Place the window kit between the window and the window frame as shown in the picture to the right. Close the window onto the window kit to form a tight seal.

Attach the exhaust duct window kit adaptor to the window kit. Tabs located on the adaptor will lock into place securing the adaptor to the window kit.

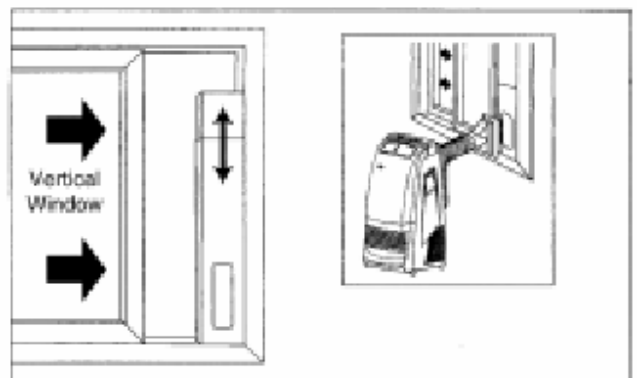
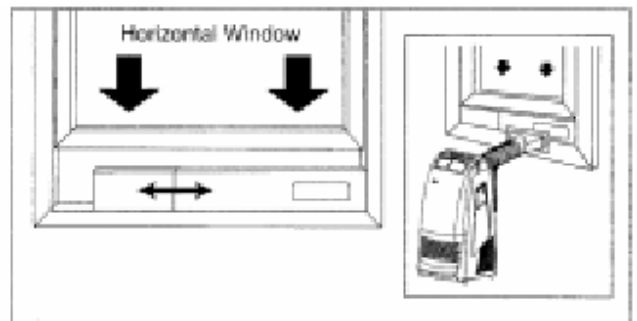

NOTE:

Using the window kit will cause the window not to be properly closed and locked. Consider taking additional security measurements.

MAINTENANCE

WARNING

We recommend you follow the cleaning and maintenance operations regularly as indicated in the instructions. Unplug the unit before performing any cleaning operations to prevent accidents caused by electrical shock.

AIR FILTER

If the air filter is clogged with dust the air flow volume is reduced. For this reason, clean the filter regularly.

To remove the air filter, lift up the filter cover and pull the air filter out from the cover.

Once the filter is dry, hook the filter onto its cover using the fastening hooks on the inside of the cover. Place the hooks on the front into the holes on the structure itself and push it back into place.

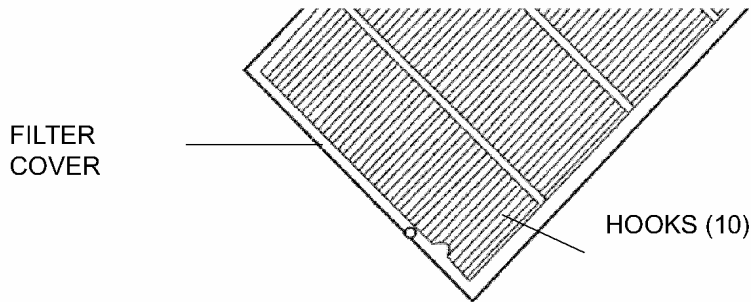
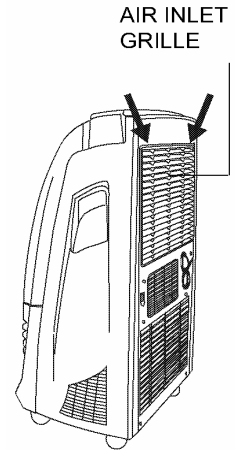

AIR CONDITIONING UNIT SURFACES

Clean the surfaces of the air conditioning unit with a damp cloth and dry it with a dust cloth.

WARNING:

KEEP AWAY FROM FLAMMABLE FLUIDS OR SUBSTANCES!

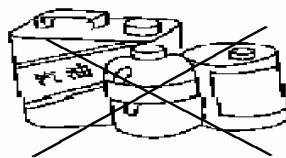
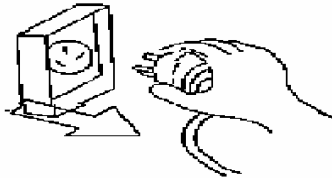

TROUBLE SHOOTING

BEFORE CALLING FOR REPAIR SERVICE, PLEASE CHECK:

PROBLEM	CAUSE	SUGGESTED SOLUTION
The air conditioner does not work	Not plugged in Defective plug or socket Fuse blown Breaker tripped	Plug in correctly. Change the plug or socket Replace fuse Reset Breaker If problem persists, contact a licensed technician.
The indicator is in the run mode but unit is not running.	The timer may be activated	Reset the timer or allow timer to time out.
Cooling mode selected, unit not operating.	Room temperature is below the temperature setting. There is frost on the evaporator.	Normal Operation The unit is defrosting. It will run after defrosting is finished.
In dehumidify mode, no cool air is coming out of the unit.	Remove the air filter and observe if frost is on the evaporator.	The unit is defrosting. It will run after defrosting is finished.
LCD window indicates "E1"	Power interruption Defective unit.	Turn unit off, disconnect from power source. Wait 10 minutes, reconnect and turn on again. If error code appears again, the unit needs to be serviced.
LCD window indicates "E4"	The water tank is full.	Drain the water.

SAFETY CAUTIONS AND SPECIAL GUIDELINES

WARNING

Avoid direct sunlight as surface discoloration may occur

Do not use the unit near water to avoid electrical shock.

Do not use near gas appliances, fires, or near flammable liquids.

Do not use the unit in the immediate vicinity of a bath, shower, or a swimming pool.

OTHER

Keep the unit 3" away from TV sets or radios to avoid the risk of electromagnetic interference.

Do not use the unit with the air outlet close to walls.

Do not cover the air outlet.

SERIOUS CAUTION

If the unit tilts over or falls and does not operate, contact your local dealer.

Do not spray with insecticide or other chemicals as the plastic case may be deformed.

SPECIAL GUIDE

This unit is a mobile air conditioner/heater, and unlike a window unit, is self contained and located within the interior of the room. For this reason, it must be exhausted properly, and depending upon the room conditions, will always cool locally.

WARRANTY

The portable air conditioning system you have purchased carries a limited warranty of one (1) year on parts and five (5) years on the compressor. Labor is not covered under warranty. Please contact your local dealer for additional details.

INTERNATIONAL REFRIGERATION PRODUCTS INC.

11325 Nations Ford Road, Suite N, Pineville, NC 28134-8393

Tel: (704)-504-8590

Fax: (704)-504-3023

950-0060