

This Owner's Manual is provided and hosted by [Appliance Factory Parts](http://www.appliancefactoryparts.com).



FISHER & PAYKEL CP-364GL Owner's Manual

[Shop genuine replacement parts for FISHER & PAYKEL
CP-364GL](#)



[Find Your FISHER & PAYKEL HVAC Parts - Select From 16 Models](#)

----- Manual continues below -----



THE PROFESSIONAL GAS COOKTOP

Use and Care Guide



MODELS:

CP-366

CP-364GL

CP-364GD

CP-484GG

CP-485GD

CP-486GL

CP-486GD



A MESSAGE TO OUR CUSTOMERS

Thank you for selecting this DCS Professional Cooktop. Because of this appliance's unique features we have developed this Use and Care Guide. It contains valuable information on how to properly operate and maintain your new appliance for years of safe and enjoyable cooking.

To help serve you better, please fill out and submit your Product Registration by visiting our website at www.dcsappliances.com and selecting "Customer Care" on the home page and then select "Product Registration". In addition, keep this guide handy, as it will help answer questions that may arise as you use your new appliance.

For your convenience, product questions can be answered by a DCS Customer Care Representative by phone: 1-888-936-7872, or email: customer.care@fisherpaykel.com.

NOTE: Please write the Model and Serial Numbers on this page for references (located on rating plate on the right side of the unit).

MODEL NUMBER _____ SERIAL NUMBER _____

NOTE: Inspect the product to verify that there is no shipping damage. If any damage is detected, call the shipper and initiate a damage claim. DCS by Fisher & Paykel is not responsible for shipping damage.

DO NOT discard any packing material (box, pallet, straps) until the unit has been inspected.

WARNING!

Improper installation, adjustment, alteration, service or maintenance can cause property damage, injury or death. Read the installation, operating and maintenance instructions thoroughly before installing, using or servicing this equipment.

WARNING!

If the information in this manual is not followed exactly, a fire or explosion may result causing property damage, personal injury or death.

Do not store or use gasoline or other flammable vapors and liquids in the vicinity of this or any other appliance.

DANGER

If You Smell Gas:

1. Do not try to light any appliance.
2. Do not touch any electrical switch; do not use any phone in your building.
3. Immediately call your gas supplier from a neighbor's phone. Follow the gas supplier's instructions.
4. If you cannot reach your gas supplier, call the fire department.
5. Installation and service must be performed by a qualified installer, service agency or the gas supplier.

WARNING!

To reduce the risk of injury to persons in the event of a cooktop grease fire, observe the following: Turn burner off first. Smother flames with a close-fitting lid, cookie sheet, metal tray, baking soda or use a dry chemical or foam-type fire extinguisher. Be careful to prevent burns. If the flames do not go out immediately evacuate and call the fire department. Never pick up a flaming pan - You may be burned. **DO NOT USE WATER ON GREASE FIRES, including wet dishcloths or towels - a violent steam explosion will result. Use an extinguisher ONLY if:**

1. You know you have a Class ABC extinguisher, and you already know how to operate it.
2. The fire is small and contained in the area where it started.
3. The fire department is being called.
4. You can fight the fire with your back to an exit.

PLEASE RETAIN THIS MANUAL FOR FUTURE REFERENCE.

TABLE OF CONTENTS

SAFETY PRACTICES	3-5
MODEL IDENTIFICATION	6
BEFORE USING YOUR APPLIANCE	7
COOKTOP USE	
Burner and Simmer Use	8
Burner Efficiency and Flame Characteristics	9
Burner Grates	10
Wok Ring (Purchase Separately)	10
GRILL USE	11-12
GRIDDLE USE	12-13
CARE AND MAINTENANCE	
Cleaning Range or Cooktop, Burners Grates	14
Burners and Igniters	15
Drip Trays and Drain Tubes, Griddle, Grill, Control Knobs	16
Backguard	17
Power Failure	17
PARTS IDENTIFICATION	18
TROUBLESHOOTING	19
HOW TO OBTAIN SERVICE	20
WARRANTY	21-22

SAFETY PRACTICES AND PRECAUTIONS

When properly cared for, your new DCS Appliance is designed to be a safe, reliable cooking appliance. When using this restaurant caliber appliance, use it with extreme care, as this type of appliance provides intense heat and can increase the accident potential. Basic safety precautions must be followed when using kitchen appliances, including the following:

- Read this Use and Care Manual thoroughly before using your new appliance. This will help to reduce the risk of fire, electric shock, or injury to persons.
- Begin by insuring proper installation and servicing. Follow the installation instructions which came with this appliance. Be sure to have a qualified technician install and ground this appliance before using.
- Have the installer show you where the gas supply shut-off valve is located so you will know how and where to turn off the gas to the appliance.
- If you smell gas, the installer may not have done a proper job of checking for leaks. You can have a small leak and therefore a faint gas smell if the connections are not completely tight. Finding a gas leak is not a “do-it-yourself” procedure. Some leaks can only be found with the burner control in the ON position; for your protection it must be done by a qualified service technician.
- If by some chance a burner goes out and gas escapes, open a window or a door to let the room air out. Do not attempt to use the appliance or turn any electrical switch on or off until the gas has had time to dissipate. Follow the instructions on page 1, “For Your Safety– if You Smell Gas”.
- This appliance has been factory assembled for natural or LP gas. It should be correctly adjusted from the factory.
- Do not repair or replace any part of this appliance unless it is specifically recommended in this manual. All other servicing should be referred to a qualified technician.
- Children should not be left alone or unattended in an area where appliances are in use. They should never be allowed to turn knobs, push buttons, sit or stand on, and/or touch on any part of an appliance while in operation.

WARNING!

Do not store items of interest to children above or at the back of any appliance. Children could be seriously injured if they should climb onto the appliance to reach these items.

- Never store anything on the cooktop. Flammable materials can catch fire, plastic items may melt or ignite and other types of items could be ruined.
- Do not hang articles from any part of the appliance. Some fabrics are quite flammable and may catch on fire.
- If the appliance is near a window be certain the curtains do not blow over or near the cooktop burners; they could catch on fire.
- Do not use water on grease fires. Turn all burners OFF, then smother fire with a metal lid, baking soda or use a dry chemical or foam-type fire extinguisher.
- Never let clothing, pot holders, or other flammable materials come in contact with, or get too close to, any burner or burner grate until it has cooled. Fabric may ignite and result in personal injury.
- Be certain to use only dry pot holders: moist or damp pot holders on hot surfaces may cause burns from steam. Do not use a towel or other bulky or frayed cloth in place of pot holders. Do not let pot holders touch hot burners, or burner grates.

SAFETY PRACTICE AND PRECAUTIONS

- For personal safety, wear proper apparel. Loose fitting garments or hanging sleeves should never be worn while using this appliance. Some synthetic fabrics are highly flammable and should not be worn while cooking.
- Do not use aluminum foil to line any part of the cooktop. This will cause heat to be trapped underneath it. This trapped heat can upset the cooking performance and can damage the finish of the cooktop parts.
- This appliance is for cooking. Never use the cooktop to warm or heat a room. This could damage the cooktop parts.



WARNING! NEVER use this appliance as a space heater to heat or warm the room. Doing so may result in carbon monoxide poisoning and overheating of the appliance.

- When using the cooktop: Do not touch the burner grates or the immediate surrounding area. Areas adjacent to the burners may become hot enough to cause burns.
- Never leave the cooktop unattended when using high flame settings. When cooking with high flame settings, boil overs may cause smoking and greasy spill overs may ignite. More importantly, if the burner flames are smothered by a severe boil over which effects the igniter, unburned gas will escape into the room.
- Only certain types of glass, heat-proof glass-ceramic, ceramic, earthen ware, or other glazed utensils are suitable for cooktop use. This type of utensil may break with sudden temperature changes. Use only on low or medium flames settings according to the manufacturer's directions. The use of professional utensils is recommended.
- Do not heat sealed food containers; a build up of pressure may cause the container to burst.
- During cooking, set the burner control so that the flame heats only the bottom of the pan and does not extend beyond the bottom of the pan. This could heat and/or melt the handles, and may increase cooking time.
- Always use utensils that have flat bottoms large enough to cover the burner. The use of undersized utensils will expose a portion of the flame to direct contact with the sides and may result in ignition of clothing.
- To minimize burns, ignition of flammable materials and unintentional spill overs, position handles of utensils inward so they do not extend over adjacent work areas, cooking areas, or the edge of the cooktop.
- Hold the handle of the pan to prevent movement of the utensil when stirring or turning food.
- Grease is flammable. Let hot grease cool before attempting to handle it. Avoid letting grease deposits collect around the cooktop burners. Clean after each use or boil over.
- For proper lighting and performance of the cooktop burners, keep the burner ports clean. It may be necessary to clean these when there is a boil spill or when the burner does not light, even though the electronic igniters click.
- Do not use the grill for cooking excessively fatty meats or products which promote flare-ups. Do not use cooking utensils on the grill.
- Clean the cooktop with caution. Avoid steam burns; do not use a wet sponge or cloth to clean the cooktop while it is hot. Some cleaners produce noxious fumes if applied to a hot surface. Follow directions provided by the cleaner manufacturer.
- Be sure all the cooktop controls are turned off and the appliance is cool before using any type of aerosol cleaner on or around the appliance. The chemical that produces the spraying action could, in the presence of heat, ignite or cause metal parts to corrode.

SAFETY PRACTICES AND PRECAUTIONS

- Clean the ventilator hood and filters above the range or cooktop frequently so grease from cooking vapors does not accumulate on them.
- Turn the ventilator OFF in case of fire or when intentionally “flaming” liquor or other spirits on the cooktop. The blower, if in operation, could unsafely spread the flames.
- DO NOT obstruct the flow of combustion or ventilation air to the appliance. Be sure a fresh air supply is available.
- For safety reasons and to avoid damage to the appliance, never sit, stand, or lean on the cooking surface.
- Service should only be done by authorized technicians. Technicians must disconnect the power supply before servicing this appliance.

WARNING!

California Proposition 65 - The burning of gas cooking fuel generates some by-products which are known by the State of California to cause cancer or reproductive harm. California law requires businesses to warn customers of potential exposure to such substances. To minimize exposure to these substances, always operate this unit according to the instructions contained in this booklet and provide good ventilation to the room when cooking with gas.

RECOMMENDATIONS ON HOOK-UP TO GAS SUPPLY:

A manual valve must be installed external to the appliance, in an accessible location from the front for the purpose of shutting off the gas supply. The supply line must not protrude beyond the back of the unit. Make sure the gas supply is turned off at the wall valve before connecting the appliance.

The gas supply connections should be made by a qualified technician and in accordance with local codes or ordinances. In the absence of a local code, the installation must conform to the latest edition of the National Fuel Gas Code ANSI Z223.1.

NOTE:

This product must be installed by a licensed plumber or gas fitter when installed within the Commonwealth of Massachusetts.

NOTE: (mandatory for the State of Massachusetts)

Alternate method of supplying gas must be installed into the unit.

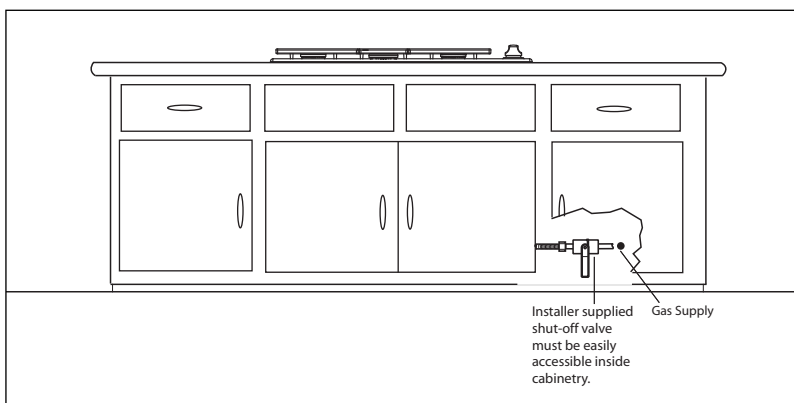

MODEL IDENTIFICATION

48" CP COOKTOP MODELS

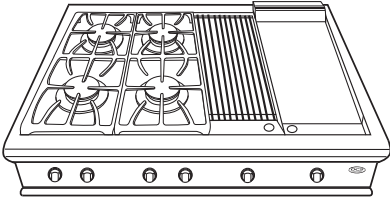

CP-484GG

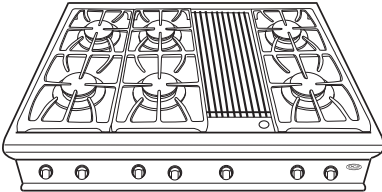

CP-486GL

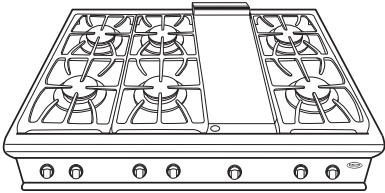

CP-486GD

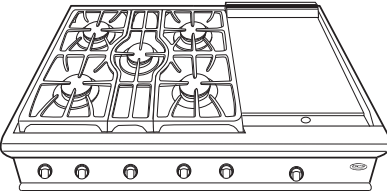

CP-485GD

36" CP COOKTOP MODELS

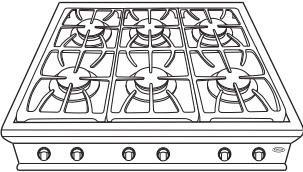

CP-366

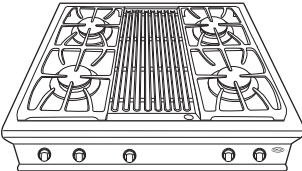

CP-364GL

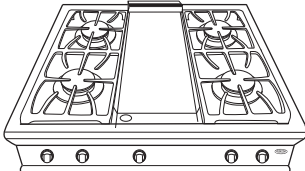

CP-364GD

BEFORE USING YOUR APPLIANCE

1. Remove all packaging materials and labels from your appliance. If the installer has not set up your appliance, do it now. Check that you have the following items:
 - Griddle cover - (CP-364GD, CP-486GD, CP-485GD, and CP-484GG Models Only)
 - Grill cover - (CP-364GL, CP-484GG, and CP-485GL)
 - Grill grates, 2 pieces - (CP-364GL, CP-486GL & CP-484GG Models Only)
 - 6 burner head assemblies, burner caps and grates (number of grates depends on the unit), (5 burner heads on CP-485GD Models Only, 4 burner heads on CP-484GG, CP-364GD and CP-364GL)
 - Radiant tray - to hold ceramic rods for grill - (CP-364GL, CP-486GL & CP-484GG Models Only)
 - One removable drip tray (griddle and grill models have drip tray liners, for catching grease)

NOTE:

If any of the listed accompanying items are missing, contact DCS at (888) 936-7872. Please be prepared with your Model #, Serial # and description of product you have purchased.

COOKTOP USE

BURNERS

Your new professional cooktop is equipped with burners typical of those used in restaurants. These burners are designed for maximum cleanability and controllability. The large cap spreads the simmer heat out to avoid too much heat being concentrated on the center of the pan. The simmer flame is always "on" when the burner is in use. The burner should never be operated if the cap is not in place. All the cooktop burners have electronic spark ignition to eliminate continuously burning pilots; when the burner is on and the flame is blown out, it will relight.

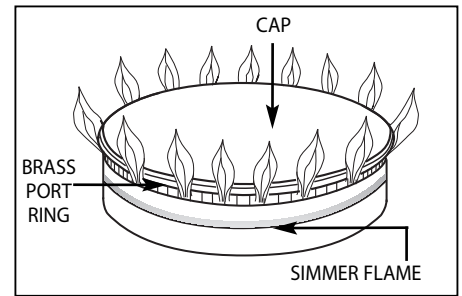
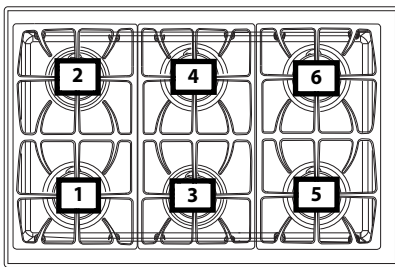

Fig. 01

SIMMERING

Your new professional cooktop has exceptionally low simmering capabilities. The large cap serves as a heat diffuser to spread out the heat to avoid having a center hotspot. Keep in mind that because of the high heat capacity of the retention flame, and the mass of the cast iron burner grates (they retain heat longer than lighter, conventional grates) some foods may continue to cook by retained heat after the burner has been turned off. Should a strong draft or boil over extinguish the simmer flame it will relight automatically as the main burner would.

Burner Location	Max. Btu/hr		Simmer/Low Btu/hr	
	Nat	LP	Nat	LP
1	17,500	15,000	500-1,200	500-1,200
2	12,500	12,500	500-1,200	500-1,200
3	12,500	12,500	500-1,200	500-1,200
4	17,500	15,000	500-1,200	500-1,200
5	17,500	15,000	500-1,200	500-1,200
6	17,500	15,000	500-1,200	500-1,200



CP-366 COOKTOP SECTION SHOWN

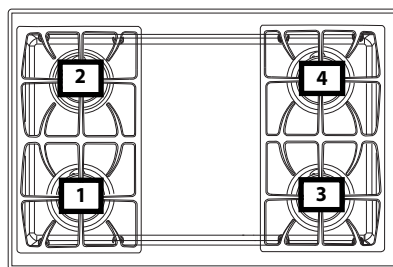

CP-364 COOKTOP SECTION SHOWN

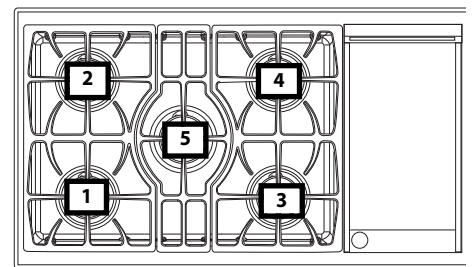

CP-485 COOKTOP SECTION SHOWN

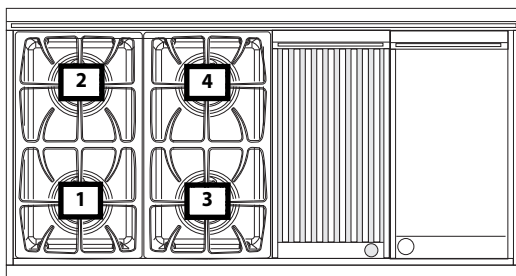

CP-484 COOKTOP SECTION SHOWN

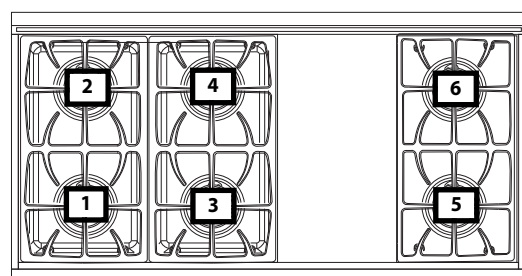

CP-486 COOKTOP SECTION SHOWN

COOKTOP USE

ELECTRONIC IGNITERS

If a burner does not ignite, listen for the clicking sound. If the igniter is not clicking, TURN OFF THE BURNER. Check the circuit breaker for a blown fuse or a tripped circuit breaker. If the igniter still fails to operate, see page 20, "Before Calling For Service". To light the burner manually, see page 17, "Power Failure".

NOTE:

If you are using propane gas, a slight pop or flash may occur at the burner ports a few seconds after the burner has been turned "OFF". This "extinction pop" is normal for propane gas.

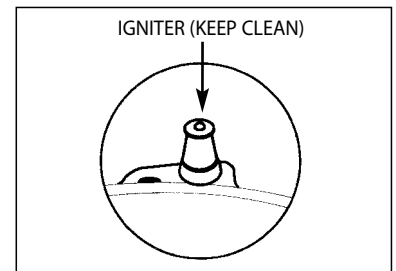

Fig. 02

BURNER EFFICIENCY AND FLAME CHARACTERISTICS

It is necessary to keep the burner ports and the igniters clean for proper lighting and efficient performance of the cooktop burners (Fig. 02). The burner flame should burn completely around the burner with no excessive noise or lifting. The flame should be blue in color and stable with no yellow tips. An improper air-gas mixture may cause either a burner flutter or a yellow tipped flame. During initial use, foreign particles in the gas line, or dust in the air around the appliance may cause an orange flame. This will disappear with use.

FLAME HEIGHT

The correct height of the flame mainly depends on the size of the bottom of the cooking utensil, the material of the cooking utensil, the amount and type of food and the amount of liquid in the utensil. Following are some basic rules for selecting flame height.

- For safety reasons the flame must never extend beyond the bottom of the cooking utensil. Never allow flames to curl up the side of the pan (see Fig. 03). This will discolor or damage the utensil.
- Utensils which conduct heat slowly (such as glass-ceramic) should be used with medium to low flame. If you are cooking with a large amount of liquid, a slightly larger flame can be used.

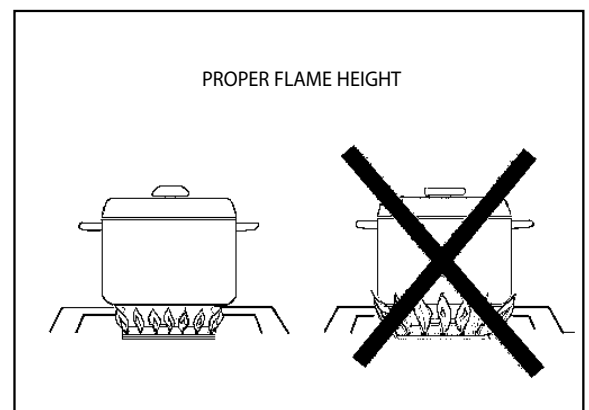

Fig. 03

COOKTOP BURNERS

The cooktop burners must be kept clean. Cleaning of the cooktop burners should include the igniter. The cooktop burners have an infinite number of heat settings and there are no fixed positions on the control knobs between "HI" and "LO". To turn the cooktop burner on, push in on the control knob and turn it counterclockwise to the "LITE" position. An audible clicking sound will be heard. When the gas has been ignited by the electronic spark igniter, turn the knob to the desired setting. (The clicking sound should stop as soon as the burner is lit).

WARNING!

When turning on any cooktop burner, be sure to stop at the "LITE" position before turning the burner to a flame setting for cooking. If the burner is not lit and it is turned beyond the "LITE" position, to HI, MEDIUM, or LO, there could be a burst of flame when the burner does light.

COOKTOP USE

BURNER GRATES

The burner grates are heavy cast iron. They have a flat surface making it easy to move large pans from one burner to another. They were designed in sections to make them easier to remove and clean. (See Fig. 04 & 05)

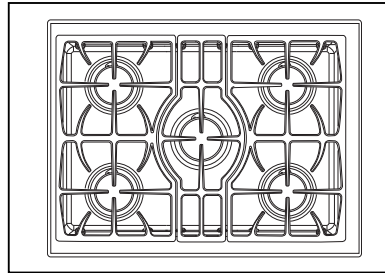

Fig. 04 (485 models)

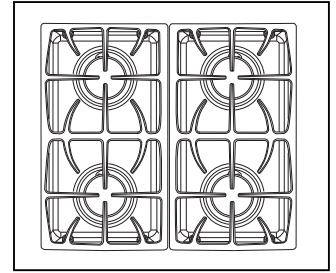

Fig. 05 (36" & 48" models)

COOKWARE

For best results we recommend using professional cookware. This type of utensil can be found at your finer department stores, specialty cooking shops, or restaurant supply stores. If using regular cookware, be very careful if the pans have plastic handles, as these large professional size burners can flame up on the outside of the pan and melt or bubble the handles.

CONTROL KNOBS

The control knobs are readily associated with the burners they control. The cooktop control knobs are labeled and are in front of the burners. The griddle controller is placed slightly lower than the other control knobs. This is due to the physical size of the commercial type thermostats used on the product.

WOK RING [Purchase separately]

A Wok ring is available as an accessory for your new DCS appliance. To purchase a wok ring accessory (model # WRS) for use on your range or cooktop please contact an authorized DCS Dealer. The ring is cast iron, and has a porcelain enamel finish. It can be used with the DCS model CW wok and most commercially available woks. To use the ring, place it on the grate over the desired burner. The vertical tabs on the ring should be aligned with the main fingers of the grate. The small protrusions on the bottom surface of the ring should straddle the grate fingers to prevent the ring from rotating during cooking. See Fig. 06. The bottom of the wok should be supported and retained by the vertical tabs of the ring.

For best performance on 36" and 48" models, the ring and wok should be used on the burners that are in positions 1,4,5, and 6 (see page 9) as they have the highest output on the top section. To clean the wok ring, place it in the dishwasher after use. Stubborn food deposits may be removed by soaking to loosen the soil, then washing as usual.

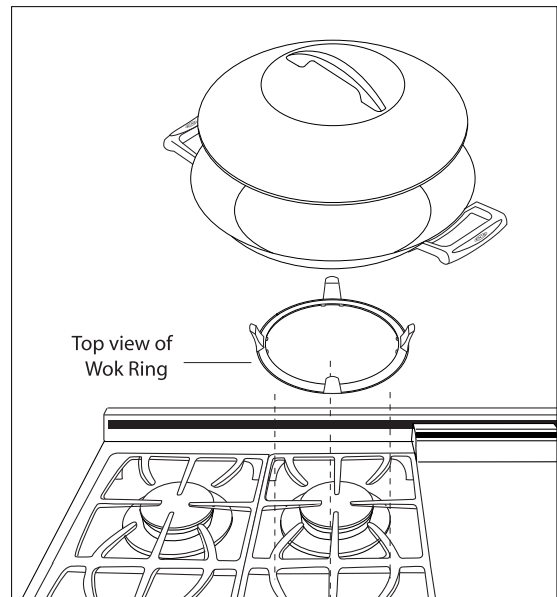

Fig. 06

GRILL USE

GRILL

The two grill grates are reversible (see Fig. 07). The grill grates are made of durable stainless steel. One side of the grate is ridged (side A) and should be used for foods where you want the fat to run off, such as steak or hamburger patties. The ridges are sloped so the fat runs toward the front of the grill and can easily run down to the cooler area of the drip tray and away from the intense heat of the burner. The other side of the grate (side B) is designed for foods that need more support while cooking, such as fish and vegetables. Food cooked on the grill section achieves the same flavor as food cooked on an outdoor grill. The intense radiant heat from the ceramic rods caramelizes the fats and juices that are brought to the surface of the food, giving it the barbecued flavor.

ELECTRIC GLOW IGNITER

The grill burners are equipped with an electric glow igniter and safety valve system which lights the gas. There will be a delay of 30 to 90 seconds after the control knob has been turned on to when you actually hear the burner come on. The burner will ignite within 4 seconds after the gas reaches the burner.

NOTE:

This gas grill may cook slightly faster than you are used to, thus preheat and grilling times should be adjusted accordingly.

CERAMIC RODS

The layer of ceramic rods, under the grill grates, will last for many years with proper care. They are shipped from the factory pre-assembled on the radiant tray, ready to be set in place into the fire box, under the grill grates. Be sure to remove any packaging material from the radiant tray and rods before using the grill. Burned food particles and ash can be emptied off the radiant tray when cool by shaking over a waste receptacle. Chipping or cracking of the ceramic rods may occur as they may get brittle with age, depending on frequency of use. This is normal and does not affect the cooking performance. Do not replace the radiant tray/ceramic rods with alternates. Contact DCS for genuine factory-direct replacement parts, 1-888-936-7872 or see page 1 for contact information.

USE OF THE GRILL

Before starting to cook on the grill, be sure the drip tray and liners are in place and that you have the grill grates turned to the side you want for grilling. Preheat the grill for 15 minutes with the control knob set on HI. Place the food on the grill. Grill it to the doneness desired. The control knob may be set to any position between "HI" and "LO". For proper searing and browning, the grill requires high heat. With large pieces of meat or poultry, you may need to turn the heat to medium to low setting after the food has been seared. This lower heat setting will allow the food to cook through without burning the outside. When using a sugary marinade or barbecue sauce, it may be necessary to turn the heat setting down near the end of the grilling time. **Do not leave the grill unattended while it is turned on.** When you are finished grilling, allow the drip trays to cool before cleaning them. They should be cleaned each time they are used.

NOTE:

The longer you preheat the grill, the darker the grill marks will appear.

EXCESSIVE FLARE UPS AND FLAMING

Occasionally grease drippings ignite. These drippings will create minor puffs of flame for a second or two. This is normal when cooking on a grill. You may find it handy to have a spray bottle filled with water to lightly spray the flare-up. If the flame becomes excessive, remove the food from the grill. Lower the heat setting. Replace the food when the flare-up subsides. To prevent flare-ups from happening, trim the fat from around the edges of steaks and chops, use hamburger that is lean, remove the fat that is on poultry, etc. When turning any kind of meat or poultry, the melted fat will drop onto the ceramic rods and it may create a flare-up. If this happens, use a long handled spatula to move the food to another area.

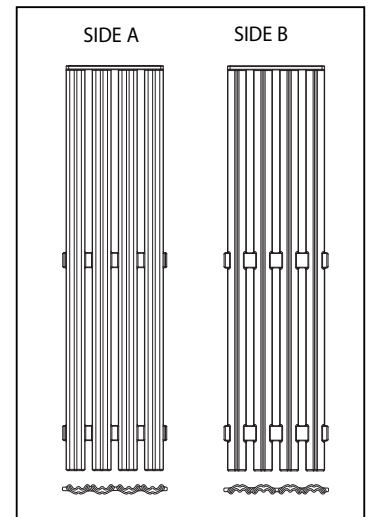

Fig. 07

GRILL USE

GRILLING HINTS

When grilling, the ventilation fan must be set on "HI" to remove smoke and odors. The fan can be turned to "LO" after cooking is complete to remove any leftover smoke.

The doneness of meat is affected by the thickness of the cut. It is impossible to cook a thin piece of meat to a rare doneness. A steak should be at least 1-inch thick to have it turn out rare and juicy. The cooking time is affected by the temperature of the meat when you start to cook it, the size and shape of the cut and the kind of meat you are cooking. The degree of doneness desired also affects the time.

When turning the meat over, always use a spatula or tongs as it will not puncture the meat allowing the juices to run out. This will help to keep the meat juicy. Turn the meat only once, as juices are lost when the meat is repeatedly turned. Be sure to trim any excess fat from meat or poultry. To prevent steaks or chops from curling while they are being cooked, slit the fat around the edges at about 2-inch intervals. To test for doneness, make a small cut in the center of the meat.

GRIDDLE USE

The built-in griddle on your cooktop is made from Type 304 stainless steel, highly polished to provide a smooth cooking surface. It is normal for it to darken with use as oils cook onto the surface to provide a stick resistant base or "seasoning". Since the griddle is made from stainless steel, the surface will not rust. The griddle burner is thermostatically controlled and cycles on and off to maintain the set temperature. The HEATING light indicates that the burner is "ON". The READY light indicates that the griddle is at the set temperature. The griddle assembly is not to be removed for cleaning and is held in place by two front screws and one rear screw. These are mainly there to keep the griddle from shifting in transit, thus avoiding breakage of any ignition components. Once the unit is installed, the rear shipping screw can be removed. It is located beneath the griddle flue cover which is removed by lifting off (be careful not to scratch your backguard during removal of the cover). Remove the center shipping screw. The two outer screws are leveling screws (Fig. 08). They can be turned to level the griddle or to provide a forward slope to help grease and oils drain away from the food being cooked. After using the griddle a few times, you will be able to judge the slope best for the foods you are cooking and your personal preference.

ELECTRIC GLOW IGNITER

The griddle burners are equipped with an electric glow igniter and safety valve system which lights the gas. There will be a delay of 30 to 90 seconds after the control knob has been turned on to when you actually hear the burner come on. The burner will ignite within 4 seconds after the gas reaches the burner.

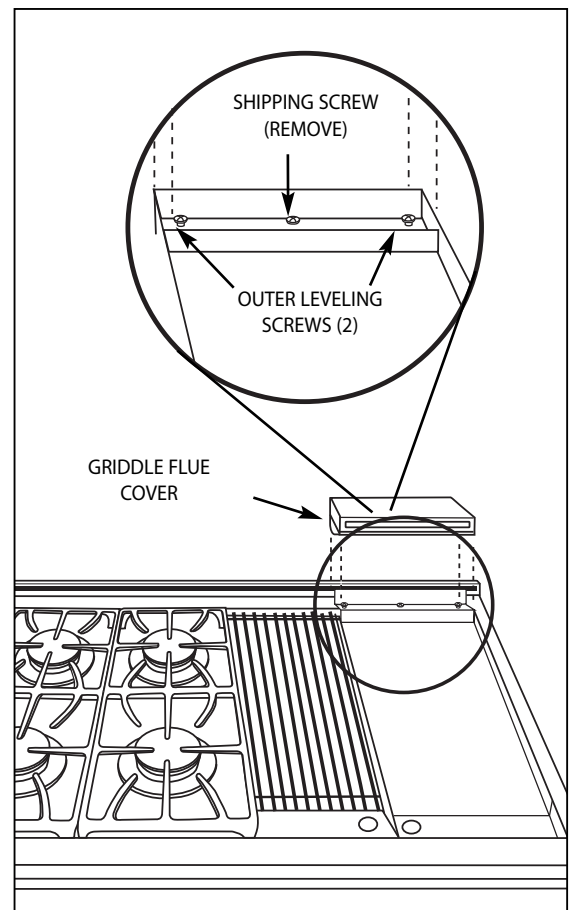

Fig. 08

GRIDDLE USE

BEFORE USING THE GRIDDLE FOR THE FIRST TIME OR TO RE-SEASON

1. Clean the griddle thoroughly with hot, soapy water to remove any protective coating.
2. Rinse with a mixture of 1 cup water and 1/4 cup white vinegar. Dry thoroughly.
3. Pour 1 teaspoon vegetable oil into the center of the griddle (do not use corn oil as it gets sticky). Rub the oil over the entire surface of the griddle using a heavy soft cloth.
4. Turn the control knob to a Medium setting (350°F). Turn the heat "Off" when the oil begins to smoke. Allow the griddle to cool.
5. Repeat Step 3. Be sure to cover the entire surface with the oil.
6. Repeat Step 4. Allow the griddle to cool. Wipe the entire surface of the griddle using a heavy soft cloth. Apply a very thin layer of vegetable oil. The griddle is now ready to use. If the griddle is not used for a period of time, re-season it occasionally.

NOTE:

It is normal for the griddle to darken with use.

USE OF THE GRIDDLE

Before starting to cook on the griddle, be sure the drip tray and liners are in place. Preheat griddle for 15 minutes with the control knob set to the temperature suggested on the cooking chart. When the griddle is preheated, the HEATING light will turn "Off" and the ready light will be "On". Place the food on the griddle and cook to desired doneness.

NOTE:

When the griddle is properly seasoned it can be used without any additional oil. However, it can be used for flavor. A light mist of non-stick vegetable spray, applied before cooking to a cool griddle, makes delicate foods easier to turn.

GRIDDLE COOKING CHART

FOOD	TEMPERATURE
Eggs	225°F to 250°F
Bacon, Ham, Pork Chops	300°F to 325°F
Sausage, Grilled Cheese Sandwiches	325°F to 350°F
Pancakes, French Toast	350°F to 375°F
Hash Brown Potatoes	400°F to 425°F

CARE AND MAINTENANCE

WHEN CLEANING THE COOKTOP:



WARNING

Be careful cleaning any part of this appliance while hot.

All parts of the appliance can be cleaned with hot soapy water, rinsed, dried and buffed to a shine with a soft, heavy pile cloth. Always try this first, as it is the mildest cleaning procedure.

1. Use the mildest cleaning procedure first. Some brands of cleaners of the same type are harsher than others, read their directions. A scent or a propellant can make a difference in the product, read the ingredients. Try on a small area first.
2. To avoid marring the surface always rub metal finishes in the direction of the polish lines. The cleaner will be more effective when used in the direction of the polish lines.
3. Use only clean sponges, soft cloths, paper towels, plastic non-metal for cleaning or scouring as recommended in this section. (Use only soap pads with soap still in them. An empty pad can scratch.)
4. Be sure to rinse all parts thoroughly and to wipe dry to avoid water marks.

BRAND NAME CLEANERS

In this section on cleaning, the use of name brands is intended only to indicate a type of cleaner. This does not constitute an endorsement. The omission of any name brand cleaner does not imply its adequacy or inadequacy. Many products are regional in distribution and can be found in local markets and department stores.

COOKTOP

Turn off all the burners and allow the grates to cool, before starting to clean the cooktop. If you wipe off any part of the cooktop while it is hot do so carefully as using a wet sponge or cloth can result in steam burns.

BURNER GRATES

When lifting the grates be careful as they are heavy. Place them on a protected surface, so they won't scratch the surface they are laid on. The burner grates are matte porcelain enamel over cast iron. When cool they may be placed in the dishwasher, or wiped clean using hot soapy water, then rinsed and wiped dry. The burner grates will not rust as they are matte porcelain enamel on both sides for durability. The occasional use of mild abrasive cleansers such as Fantastik®, Simple Green® or Formula 409® is okay. Abrasive cleansers, used vigorously or too often, can eventually harm the enamel. Apply with a damp sponge, rinse thoroughly and dry. The porcelain may pop off the edge of the grates due to rapid temperature change when the burners are turned on. Do not be concerned as this does not result in the deterioration of the grates. The cast iron soon darkens to blend with the porcelain enamel. Be careful when wiping an area where the porcelain has popped off, as the edges may be sharp.

CARE AND MAINTENANCE

BURNERS

For proper lighting and performance keep the burners clean. It is necessary to clean the burners if they do not light even though the igniter clicks, if there has been a severe boil over, or when the flame does not burn blue. Be certain all burner knobs are in the off position before attempting to clean the burners. The burners have been designed for ease in cleaning. When the grates and burners are cool, remove the grate. The burner cap and the brass port ring can easily be lifted off. Wash these parts in hot soapy water, rinse and dry thoroughly. The burner caps are porcelain enamel, follow the directions on the previous page that were given for the burner grates. A bristle brush can be used to clean out the toothed burner ports, if necessary. Disassembly of the simmer ring is not recommended, however, it may become necessary to do so if the ports remain clogged after normal cleaning. If it is necessary to disassemble the simmer ring from the base, remove the hex nut at the top of the simmer ring. Clean the simmer ring with hot soapy water using a soft wire or plastic bristle brush then dry thoroughly. Re-assemble the parts using the hex nut. After cleaning, it is important to make sure the locating pin on the bottom side of the simmer ring is properly aligned with the corresponding hole in the base and that the two locating pins (see insert-Fig.09) in the bottom side of the brass port ring are properly aligned with the locating notch and center holes on the top side of the simmer ring. Incorrect alignment will produce a potentially dangerous flame and poor burner performance (see Fig. 09).

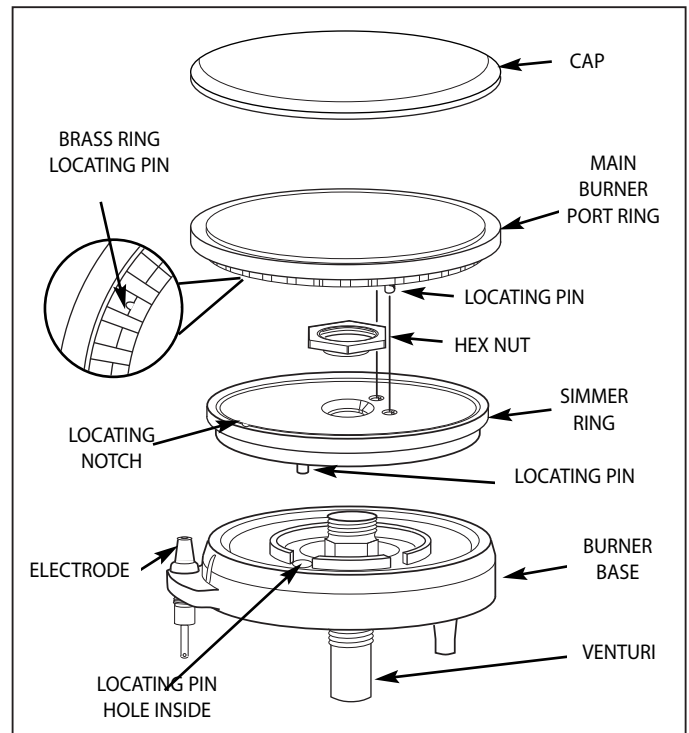

Fig. 09

IGNITERS

Wipe with a rubbing alcohol dampened cotton swab. Be careful not to damage the igniter (see Fig. 10).

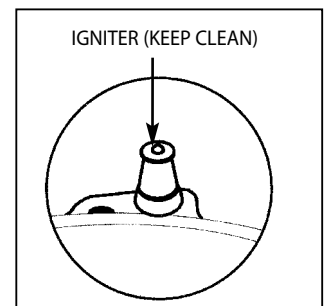

Fig. 10

SUMP AREA AROUND BURNERS AND IGNITERS

Remove grates. With a warm wet sponge, apply a soap that will release (like Dawn). Clean up soiled area around the sump.

FOR HARD TO CLEAN SOIL, USE THIS METHOD:

If residue is still left, make a paper collar around the burner and igniter and tape it together (Fig. 11). Spray "Easy Off or SOS" oven spray using the cool method on soiled area. Cover it with a paper towel and leave it on the area at least 4 hours or overnight (Fig. 12). With a warm moist sponge, remove the oven spray and soil. Dry with a soft cloth.

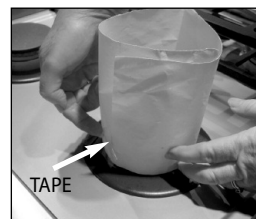

Fig. 11



Fig. 12

DRIP TRAYS AND DRAIN TUBES

If you have a griddle or a grill there will be a tray liner located inside of the drip tray (Fig. 13). The drip trays are made of stainless steel. The drip trays are on rollers so they are easy to remove and replace.

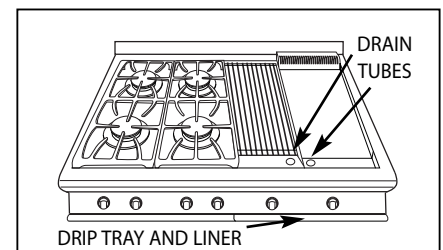

Fig. 13

CARE AND MAINTENANCE

To remove tray liner:

- Pull tray out until it stops.
- Remove inner trays for cleaning.

To remove drip tray: (if needed)

- Pull tray out until it stops.
- Remove inner trays.
- Push in latches on the sides of the slides while pulling out the drip tray (Fig.14).
- Continue pulling the tray out.

To install drip tray:

- Align the side of the drip tray with the slide guides (Fig. 15).
- Push the tray in until it stops.
- Pull the tray forward and push in and out several times to engage rollers.

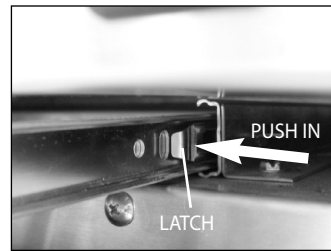

Fig. 14

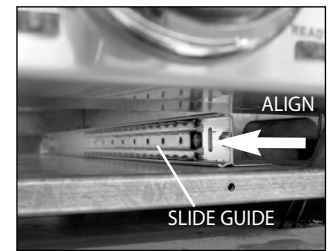

Fig. 15

To remove, pull the tray forward. If something has spilled into the trays it should be cleaned up as soon as possible to prevent “baked on” food soil. Grease from the griddle or the grill drains through the drain tube into the tray and liner below. **Do not allow the grease to accumulate in the tray as it can be a fire hazard.** Clean the tube and tray as soon as they are cool. Clean with hot soapy water. For the tube use a soapy bottle brush. Ensure the drip tray is in place when cleaning the drain tube. A mild abrasive cleaner such as Fantastik®, Simple Green® or Formula 409® can be used. (Do not use steel wool pad, or a harsh abrasive such as: Comet® or Ajax®.) Rinse and dry all parts thoroughly.

GRIDDLE

Thoroughly clean the griddle of grease and food particles while it is still hot, taking care not to scratch the griddle, using a square edged spatula or brass brush. Once the griddle has cooled to a lukewarm temperature, rub the surface lightly with vegetable oil (do not use corn oil, it gets sticky). Thoroughly wipe the griddle with a heavy coarse cloth or burlap to remove any remaining residue and food particles. If you have a grease build-up, use one tablespoon of vinegar in a 1/2 cup of water, clean with a scouring cloth such as a Chore Boy® Scouring Cloth. For heat discoloration use a stainless steel cleaner for heat stains such as Revere Ware® Stainless Steel Cleaner. Wash with hot soapy water, rinse and dry. If food soil or residue is cooked onto the griddle, use a griddle stone (fine grained pumice), or a griddle pan and screen cleaner (these are both available at restaurant supply store), following the manufacturers’ directions. Wash with hot soapy water, rinse and dry. If hot soapy water, vinegar, or scouring powder are used to clean the griddle, it must be re-seasoned. Follow the directions on page 13 to reseason the griddle.

NEVER FLOOD THE HOT GRIDDLE WITH COLD WATER. This could cause the griddle to crack or warp.

GRILL

Clean the grill immediately after cooking. Turn off the burner. To protect your hand from steam and heat, wear a barbecue mitt. Scrub the grill by dipping a brass bristle barbecue brush frequently into a bowl of warm water. The steam created softens the food particles and assists the cleaning process. The food particles will drop into the drip tray or into the radiant tray holding the radiants. Be sure to clean the drain tube, drip tray and liner after they have cooled. Follow directions above. The radiant tray and radiants should be removed periodically (when cool) and shaken gently over a layer of newspaper, which can be thrown away.

CONTROL KNOBS

These are die-cast metal with plastic grips and can be cleaned in hot, soapy water. To remove the knobs from the control panel, grasp the knob and pull straight back towards you and away from the cooktop. Wash, do not soak. Rinse and dry thoroughly. It is important to replace these knobs on the correct gas valve, on the control panel. The cooktop and grill control knobs are similar, the cooktop knobs have a setting for “Simmer”, the grill does not. The griddle control knob has temperatures on it.

CARE AND MAINTENANCE

BACKGUARD (if installed)

This is made of stainless steel. Use the mildest cleaning procedure first. Hot soapy water, rinse and dry. If the panel has food soil remaining, try a general kitchen cleaner, such as Fantastik®, Simple Green® or Formula 409®. Apply cleaner with a damp sponge, rinse thoroughly and dry. Always scrub lightly in the direction of the grain. Do not use a steel wool pad, it will scratch the surface. To touch up noticeable scratches in the stainless steel, sand very lightly with dry 100 grit emery paper, rubbing in the direction of the grain. After cleaning use a stainless steel polish, such as Stainless Steel Magic®. If the rear top burners are used extensively on high it is possible for the vertical stainless steel panel to discolor from the burner heat. This discoloration can be removed by using Revere Ware Stainless Steel Cleaner.

POWER FAILURE

To light the cooktop burners, turn the control knob to "LITE", hold a lighted match to the port ring. After the flame is burning all the way around the burner, adjust the flame. It is necessary to light each burner separately, each time you want to use it. Do not attempt to match light the griddle, grill, broil, or oven burners; they will not function without any electrical power. Make sure knobs are in the "OFF" position should power be restored and you are away from the unit. Do not leave the burner unattended. The burner will not relight if blown out.

PARTS IDENTIFICATION

ITEM	DESCRIPTION
1	Grill
2	Burner Grates
3	Giddle
4	Grill Grates
5	Giddle Control Knob
6	Grill Control Knob
7	Cooktop Control Knob
8	Grill Cover
9	Giddle Cover

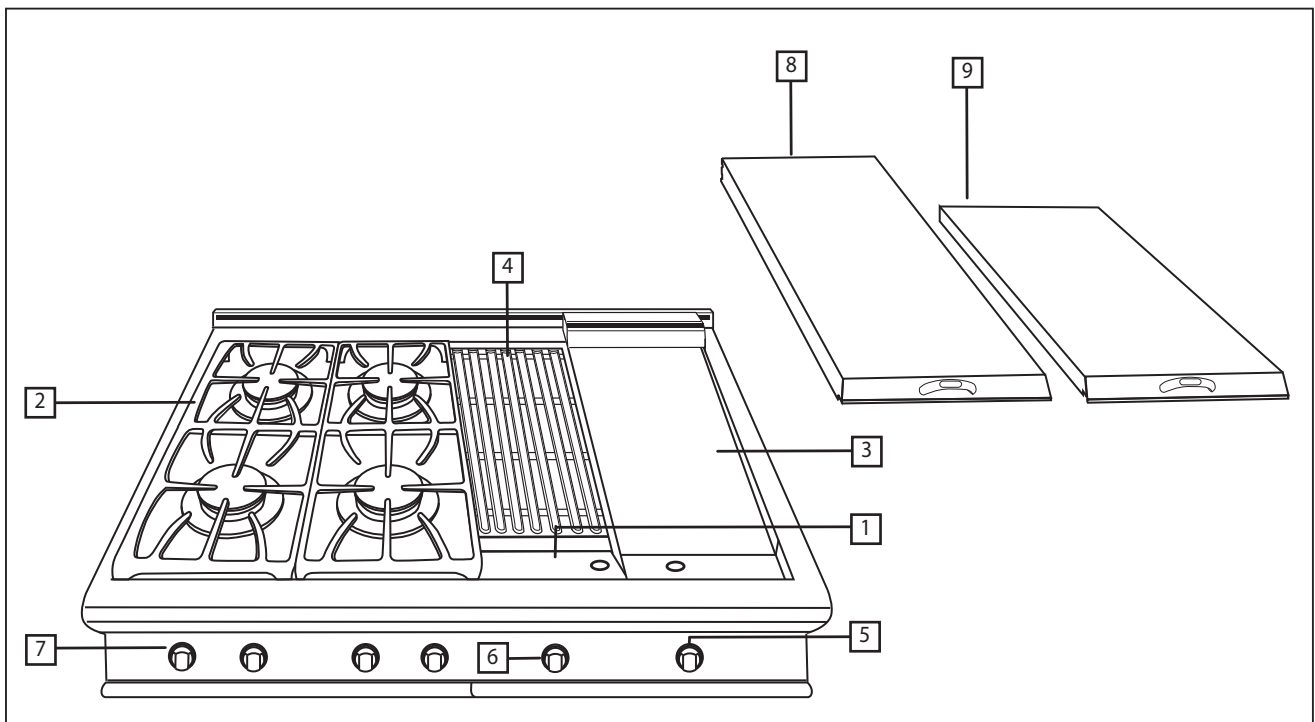

MODEL CP-484GG SHOWN

NOTE: RATING PLATE LOCATED ON THE BACK OF THE UNIT

TROUBLESHOOTING

RANGES & COOKTOPS		
PROBLEM	POSSIBLE CAUSE	SOLUTION
NON FUNCTIONAL	NO ELECTRICITY OR GAS SUPPLY	TURN ON GAS SUPPLY VALVE
	TECHNICAL	CALL AUTHORIZED SERVICE
ONE OR MORE BURNERS WILL NOT LIGHT	NO ELECTRICITY	CHECK CIRCUIT BREAKERS
	NO GAS	CHECK GAS SUPPLY AT WALL
	WRONG GAS	VERIFY GAS TYPE (SEE PAGE 20 FOR LOCATION OF LABEL)
	DIRTY BURNERS	CLEAN BURNERS
	BURNERS MIS-ALIGNED	ALIGN & REASSEMBLE BURNERS
	WATER IN BURNER(S)	DIS-ASSEMBLE & DRY BURNER(S)
	DIRTY ELECTRODE	CLEAN BURNER ELECTRODE
INCORRECT FLAME SOOTY BURNER FLAME	TOO LARGE OR SMALL MIS-ALIGNED BURNER ASSY	VERIFY GAS TYPE (SEE LABEL ON BACK) REALIGN AND RE-ASSEMBLE BURNER ASSY (PAGE 15)
RANGE GRIDDLE & GRILL		
PROBLEM	POSSIBLE CAUSE	SOLUTION
NON FUNCTIONAL	NO ELECTRICITY OR GAS SUPPLY	TURN ON GAS SUPPLY VALVE
	RADIANT TRAY IMPROPERLY INSTALLED	RE-INSTALL RADIANT TRAY CORRECTLY
	TECHNICAL	CALL AUTHORIZED SERVICE
LOW HEAT	PLUGGED BURNER PORTS	SEE PAGE 15 FOR BURNER CLEANING PROCEDURE

HOW TO OBTAIN SERVICE

BEFORE YOU CALL FOR SERVICE

- Is the circuit breaker tripped or the fuse blown?
- Is there a power outage in the area?
- See Troubleshooting on page 19.

IF THE COOKTOP BURNERS DO NOT LIGHT

- Is the two piece burner assembled correctly? (See page 15, Fig. 09)
- Is the burner head assembly aligned correctly? (See page 15, Fig. 09)
- Is the manual shut-off valve open? This is usually located where the gas comes out of the wall.

For warranty service, please contact DCS Customer Care Representative at (888) 936-7872. Before you call, please have the following information ready:

- Model Number (located on rating plate on the right side of the unit).
- Serial Number (located on rating plate on the right side of the unit).
- Date of installation
- A brief description of the problem

Your satisfaction is of the utmost importance to us. If a problem cannot be resolved to your satisfaction, please call, write or email us at:

Fisher & Paykel Appliances, Inc.
Attention: DCS Customer Care
5900 Skylab Road
Huntington Beach, CA 92647

email: customer.care@fisherpaykel.com

WARRANTY

LIMITED WARRANTY

When you purchase a new DCS Professional Cooktop, you automatically receive a One Year Limited Warranty covering parts and labor for the entire product, a Five Year Limited Warranty on surface burners, griddle burner and grill burner (parts only), for servicing within the 48 mainland United States, Hawaii, Washington D.C. and Canada. In Alaska the Limited Warranty is the same except that you must pay to ship the Product to the service shop or the service technician's travel to your home. Products for use in Canada must be purchased through the Canadian distribution channel to ensure regulatory compliance.

FISHER & PAYKEL UNDERTAKES TO:

Repair without cost to the owner either for material or labor any part of the Product, the serial number of which appears on the Product, which is found to be defective. In Alaska, you must pay to ship the Product to the service shop or for the service technician's travel to your home.

If we are unable to repair a defective part of the Product after a reasonable number of attempts, at our option we may replace the part or the Product, or we may provide you a full refund of the purchase price of the Product (not including installation or other charges).

This warranty extends to the original purchaser and any succeeding owner of the Product for products purchased for ordinary single-family home use. All service under this Limited Warranty shall be provided by Fisher & Paykel Appliances Inc. or its Authorized DCS Service Agent during normal business hours.

HOW LONG DOES THIS LIMITED WARRANTY LAST?

Our liability under this Limited Warranty for the entire product expires One Year from the date of purchase of the Product by the first consumer. Our liability under this Limited Warranty for surface burners, griddle burners and grill burner (parts only) expires Five Years from the date of the purchase of the Product by the first customer.

Our liability under any implied warranties, including the implied warranty of merchantability (an unwritten warranty that the Product is fit for ordinary use) also expires One Year (or such longer period as required by applicable law) from the date of purchase of the Product by the first consumer. Some states do not allow limitations on how long an implied warranty lasts, so this limit on implied warranties may not apply to you.

THIS WARRANTY DOES NOT COVER:

- A. Service calls that are not related to any defect in the Product. The cost of a service call will be charged if the problem is not found to be a defect of the Product. For example:
1. Correct faulty installation of the Product.
 2. Instruct you how to use the Product.
 3. Replace house fuses, reset circuit breakers, correct house wiring or plumbing, or replace light bulbs.
 4. Correct fault(s) caused by the user.
 5. Change the set-up of the Product.
 6. Unauthorized modifications of the Product.
 7. Noise or vibration that is considered normal, for example, drain/fan sounds, regeneration noises or user warning beeps.
 8. Correcting damage caused by pests, for example, rats, cockroaches etc.

WARRANTY

- B. Defects caused by factors other than:
 - 1. Normal domestic use or
 - 2. Use in accordance with the Product's Use and Care Guide.
- C. Defects to the Product caused by accident, neglect, misuse, fire, flood or Act of God.
- D. The cost of repairs carried out by non-authorized repairers or the cost of correcting such unauthorized repairs.
- E. Travel Fees and associated charges incurred when the product is installed in a location with limited or restricted access. (i.e. airplane flights, ferry charges, isolated geographic areas).
- F. Normal recommended maintenance as set forth in the Product's Use and Care Guide.

If you have an installation problem contact your dealer or installer. You are responsible for providing adequate electrical, exhausting and other connection facilities.

We are not responsible for consequential or incidental damages (the cost of repairing or replacing other property damaged if the Product is defective or any of your expenses caused if the Product is defective). Some states do not allow the exclusion or limitation of incidental or consequential damages, so the above limitation or exclusion may not apply to you.

HOW TO GET SERVICE

Please read your Use and Care Guide. If you then have any questions about operating the Product, need the name of your local DCS Authorized Service Agent, or believe the Product is defective and wish service under this Limited Warranty, please contact your dealer or call us at:

TOLL FREE 1-888-936-7872 or contact us through our web site: www.dcsappliances.com

You may be required to provide reasonable proof of the date of purchase of the Product before the Product will be serviced under this Limited Warranty.

COMMERCIAL USE

This warranty applies to appliances used in residential applications; it does not cover their use in commercial situations.

NO OTHER WARRANTIES

This Limited Warranty is the complete and exclusive agreement between you and Fisher & Paykel Appliances Inc. regarding any defect in the Product. None of our employees (or our Authorized Service Agents) are authorized to make any addition or modification to this Limited Warranty.

Warrantor: Fisher & Paykel Appliances, Inc.

If you need further help concerning this Limited Warranty, please call us at the above number, or write to:

Fisher & Paykel Appliances, Inc.
5900 Skylab Road, Huntington Beach, CA 92647

This Limited Warranty gives you specific legal rights, and you may also have other rights which vary from state to state.

Fisher & Paykel Appliances Inc. is a leading manufacturer of premium quality cooking and specialty appliances under the Fisher & Paykel and DCS brands.



Quality provided by Fisher & Paykel Appliances Inc.

Fisher & Paykel Appliances, Inc.
5900 Skylab Road, Huntington Beach, CA 92647
Customer Care: 888.936.7872
Fax: 714.372.7003
www.dcsappliances.com

Nous améliorons constamment ses produits et se réserve le droit de modifier les spécifications ou la conception de ses produits sans aucun préavis.

As product improvement is an ongoing process, we reserve the right to change specifications or design without notice.

P/N 238635 Rev. B
Litho in USA 08/2008