

This Owner's Manual is provided and hosted by [Appliance Factory Parts](#).



Wolf CT30G/S Owner's Manual

[Shop genuine replacement parts for Wolf CT30G/S](#)



[Find Your Wolf Gas Range Parts - Select From 44 Models](#)

----- Manual continues below -----

GAS COOKTOPS



USE & CARE INFORMATION

WOLF[®]



CONTENTS

Introducing Wolf Gas Cooktops	3
Safety Instructions and Precautions	4
Wolf Gas Cooktop Features	8
Wolf Gas Cooktop Use & Care	10
Wolf Troubleshooting Guide	17
Wolf Service Information	18
Wolf Warranty	19

As you read this Use & Care Information, take particular note of the **CAUTION** and **WARNING** symbols when they appear. This information is important for safe and efficient use of the Wolf equipment.

⚠ CAUTION

signals a situation where minor injury or product damage may occur if you do not follow instructions.

⚠ WARNING

states a hazard that may cause serious injury or death if precautions are not followed.

In addition, this Use & Care Information may signal an **IMPORTANT NOTE** which highlights information that is especially important.



THANK YOU

Your purchase of a Wolf gas cooktop attests to the importance you place upon the quality and performance of your cooking equipment. We understand this importance and have designed and built your cooktop with quality materials and workmanship to give you years of dependable service.

We know you are eager to start cooking, but before you do, please take some time to read this Use & Care Information. Whether you are a beginning cook or an expert chef, it will be to your benefit to familiarize yourself with the safety practices, features, operation and care recommendations of the Wolf gas cooktop.

We appreciate your choice of a Wolf Appliance product and welcome any suggestions or comments you may have. To share your opinions with us, call 800-332-9513.

Your Wolf gas cooktop is protected by a warranty that is one of the finest in the industry. Take a moment to read the warranty statement on page 19 and refer to it should service become necessary.

If service is necessary, refer to the model and serial number of the gas cooktop. Both numbers are listed on the product rating plate located on the underside of the cooktop. Refer to the illustration below.

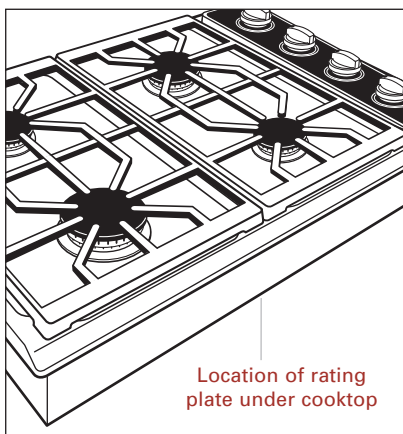

Location of rating plate under cooktop

Rating plate location

⚠ WARNING

If the information in this book is not followed exactly, a fire or explosion may result, causing property damage, personal injury or death.

IMPORTANT NOTE:

- Installation and service must be performed by a qualified installer, service agency or the gas supplier.
- Warranty service must be performed by a Wolf authorized service center.
- Do not store or use gasoline or other flammable vapors and liquids in the vicinity of this or any other appliance.
- A ventilation hood or downdraft system is recommended for use with the Wolf gas cooktop.

WHAT TO DO IF YOU SMELL GAS:

- Do not try to light any appliance.
- Do not touch any electrical switch.
- Do not use any phone in your building.
- Immediately call your gas supplier from a neighbor's phone. Follow the gas supplier's instructions.
- If you cannot reach your gas supplier, call the fire department.

CONTACT INFORMATION

Wolf Customer Service:
800-332-9513

Website:
wolfappliance.com

SAFETY INSTRUCTIONS AND PRECAUTIONS



WHAT TO DO

- **IMPORTANT NOTE: Read all instructions before using this appliance.**
- **Read this Use & Care Information carefully before using your new cooktop** to reduce the risk of fire, electric shock or injury to persons.
- **Ensure proper installation and servicing.** This appliance must be properly installed and grounded by a qualified technician. Have installer show you where the gas supply shut-off valve is located in your home. Learn how and where to turn off the gas to the cooktop.
- **Before performing any service, turn off the gas supply** by closing the gas shut-off valve and unplugging the cooktop electrical power cord from the wall receptacle.
- **Keep igniters clean and dry** for proper lighting and performance of the burners.
- **In the event that a burner goes out and gas escapes, open a window** or a door. Wait at least five minutes before using the cooktop.
- **Adequate supply of air.** Your kitchen must provide an adequate supply of fresh air to ensure proper combustion and ventilation.
- **Start the ventilation hood** approximately five minutes before cooking on the cooktop; this establishes an air curtain, and improves the capture of vapor and moisture.
- **Wear proper apparel.** Never let loose clothing or other flammable materials come in contact with the burners while in operation. Fabric may ignite and cause personal injury.
- **Always use dry pot holders when removing pans from the cooktop.** Wet or damp pot holders can cause steam burns. Do not use a towel or bulky cloth in place of pot holders.
- **Choose pans with easily grasped handles** that will stay cool while cooking. Refer to Cookware Selection on page 14.
- **When cooking, set burner controls** so that the flame does not extend beyond the bottom of the pan.
- **Always turn panhandles inward** so they do not extend over adjacent work areas, burners or the edge of the cooktop.



WHAT **NOT** TO DO

- **Always check the positions of the control knobs** to make certain the cooktop is off when you are finished cooking.
- **When deep fat frying, be sure that the pan is large enough** to accommodate the desired volume of food without overflow caused by bubbling of the fat. Never leave a deep fat fryer unattended. Avoid deep fat frying of moist or frost-covered foods, as foods with high water content may cause spattering or spilling of the hot fat. Heat fat slowly, and stir together any combinations of oils and fats prior to applying heat. Use a deep fat frying thermometer to avoid heating the fat to temperatures above the flash point.
- **Always light each burner prior to placing a pan on the burner grate.** Also, turn the control knob to the OFF position before removing a pan from the burner grate.
- **Do not repair or replace any part of the cooktop** unless specifically recommended in literature accompanying this appliance. All service should be referred to a qualified technician.
- **Do not obstruct the flow of combustion and ventilation air.**
- **Do not use aluminum foil** to line any part of the cooktop.
- **Never use the cooktop to warm or heat the room.**
- **Do not store flammable materials near burners** or let grease or other flammable substances accumulate on the cooktop.
- **Do not use abrasive or caustic cleaners** or detergents on this appliance as these may cause permanent damage. Do not use aerosol cleaners as these may be flammable or cause corrosion of metal parts.
- **Do not store or use gasoline** or other flammable vapors and liquids in the vicinity of this or any other appliance.
- **Keep appliance area clear** and free from combustible material.

SAFETY INSTRUCTIONS AND PRECAUTIONS



WHAT NOT TO DO

- **Do not block or obstruct the holes in the cooktop surface** below the control knobs. Blocking these holes may affect burner operation and may result in a hazard.
- **When using the cooktop, do not touch the grates**, burner caps, burner bases or any other parts in proximity to the flame. These components may be hot enough to cause burns.
- **If the cooktop is near a window, do not use long curtains** as a window treatment, as they could blow over the cooktop and create a fire hazard.
- **Do not leave children alone or unattended** in the area where the cooktop is in use. Never allow children to sit or stand on the appliance. Do not let children play with the cooktop.
- **Do not store items of interest to children above or at the back of the cooktop**, as they could climb on the appliance to reach items and be injured.
- **Do not use water on grease fires.** Smother the flame or use a dry chemical or foam-type extinguisher.
- **Never leave the appliance unattended when in use.** Boilovers and greasy spills may smoke or ignite.
- **Do not cover the burners and grates** with anything except properly selected utensils. Decorative covers should not be used.
- **Do not heat unopened food containers** such as baby food jars and cans. Pressure buildup may cause the container to burst and cause injury.
- **Do not clean the cooktop while it is still hot.** If using a damp sponge or cloth, wait until the cooktop has cooled sufficiently to prevent steam burns. Also, some cleaners can produce harmful or unpleasant fumes if applied to hot surfaces. Refer to Care Recommendations on page 15.



SAFETY PRECAUTIONS

⚠ WARNING

TO REDUCE THE RISK OF INJURY TO PERSONS IN THE EVENT OF A COOKTOP GREASE FIRE, OBSERVE THE FOLLOWING:

Smother flames with a close-fitting lid, baking sheet or other metal tray, then turn off the gas burner. Be careful to prevent burns. If the flames do not go out immediately, evacuate and call the fire department.

Do not use water on grease fires.

Never pick up a flaming pan—you may be burned.

USE AN EXTINGUISHER ONLY IF:

- **You know you have a Class ABC extinguisher** and you already know how to operate it.
- **The fire is small and contained** in the area where it started.
- **The fire department is being called.**
- **You can fight the fire with your back to an exit** (NFPA Fire Safety Tips).

CALIFORNIA PROPOSITION 65

⚠ WARNING

Burning gas cooking fuel generates some by-products that are on the list of substances known to cause cancer or reproductive harm. To minimize exposure to these substances, always operate this unit according to the instructions contained in this book and provide good ventilation.

COMMONWEALTH OF MASSACHUSETTS

- **Installations and repairs must be performed by a qualified or licensed contractor, plumber or gas fitter**, qualified or licensed by the state, province or region where this appliance is being installed.
- **Use only gas shut-off valves approved for use** within the state, province or region where this appliance is being installed.
- **A flexible gas connector, when used, must not exceed 3' (.9 m).**



GAS COOKTOP FEATURES



Model CT15G

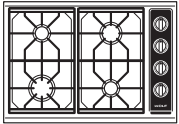

Model CT30G

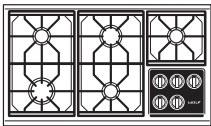

Model CT36G

- Available in natural and LP gas
- Stainless steel top construction, available in classic and platinum stainless steel finishes—Model CT15G available in classic finish only
- Dual-stacked, sealed burners with automatic reignition on all settings
- Individual spark ignition system
- Illuminated control panel with two-tiered control knobs
- True Simmer setting on all burners
- Low-profile, cast iron continuous burner grates with matte porcelain finish
- Seamless drawn burner pan
- CSA certified for US and Canada
- Two and five year residential warranty—exclusions apply—see warranty at the end of this guide

15" (381) GAS COOKTOP

- One medium 12,000 Btu/hr (3.5 kW) sealed burner with 800 Btu/hr (.2 kW) delivered at simmer
- One small 9,200 Btu/hr (2.7 kW) sealed burner with 300 Btu/hr (.1 kW) delivered at simmer
- Gas rating: 21,200 Btu/hr (6.2 kW)

30" (762) GAS COOKTOP

- One large 15,000 Btu/hr (4.4 kW) sealed burner with 800 Btu/hr (.2 kW) delivered at simmer
- One medium 12,000 Btu/hr (3.5 kW) sealed burner with 800 Btu/hr (.2 kW) delivered at simmer
- Two small 9,200 Btu/hr (2.7 kW) sealed burners with 300 Btu/hr (.1 kW) delivered at simmer
- Gas rating: 45,400 Btu/hr (13.3 kW)

MODEL CT15G
15" (381) Gas Cooktop

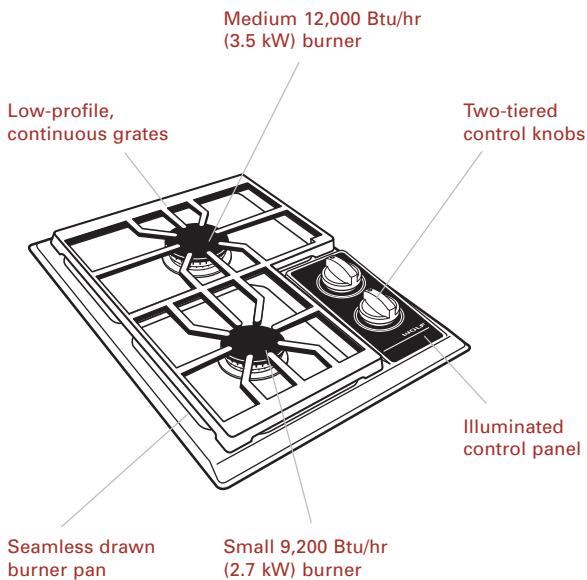

MODEL CT30G
30" (762) Gas Cooktop

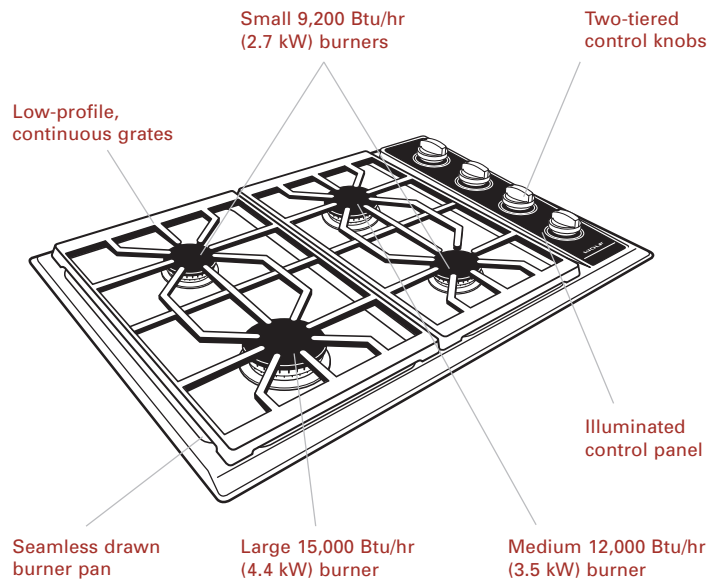



GAS COOKTOP ACCESSORIES

36" (914) GAS COOKTOP

- One large 15,000 Btu/hr (4.4 kW) sealed burner with 800 Btu/hr (.2 kW) delivered at simmer
- One medium 12,000 Btu/hr (3.5 kW) sealed burner with 800 Btu/hr (.2 kW) delivered at simmer
- Three small 9,200 Btu/hr (2.7 kW) sealed burners with 300 Btu/hr (.1 kW) delivered at simmer
- Gas rating: 54,600 Btu/hr (16 kW)

These optional accessories are available through your Wolf dealer. To obtain local dealer information, visit the Locator section of our website, wolfappliance.com.

- One-piece wok and single burner grate (Models CT30G and CT36G)
- Filler strip
- Bracket supports for installation of two integrated modules with a downdraft ventilation system (Model CT15G)
- High altitude conversion kit

ACCESSORIES

Optional accessories are available through your Wolf dealer. To obtain local dealer information, visit the Locator section of our website, wolfappliance.com.



These appliances are certified by Star-K to meet strict religious regulations in conjunction with specific instructions found on www.star-k.org.

MODEL CT36G
36" (914) Gas Cooktop

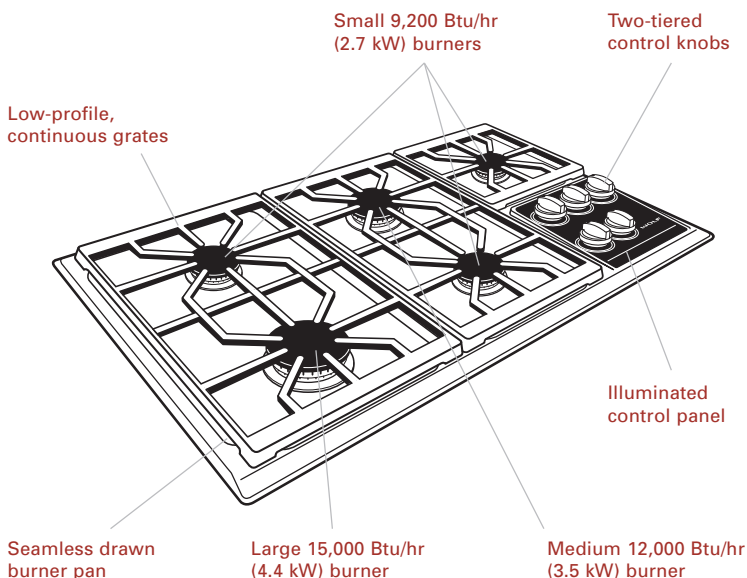

Dimensions in parentheses are in millimeters unless otherwise specified.



ILLUMINATED **CONTROL PANEL**

The control panel of your gas cooktop is illuminated for instant visual indication that any one or more burners are in use. It is a safety signal reminding you that a flame is on and active. The illustration below shows the control panel of the 36" (914) gas cooktop.

WOLF
WARRANTY

Wolf products are covered by a two and five year residential warranty (exclusions apply). See warranty details at the end of this guide.

CONTROL KNOBS

Each control knob is positioned to correspond to the burner regulated.

For the 15" (381) and 36" (914) cooktops, the knob on the lower left side regulates the lower left burner. Conversely, the knob on the upper right side regulates the upper right burner. The illustration below shows the configuration of the control knobs for the 36" (914) gas cooktop.

Each knob on the 30" (762) cooktop control panel has a diagram above it. The diagram shows which burner it regulates.

It is normal for the knobs to be slightly raised above the surface. This space is an air inlet necessary for good combustion of gas. Each knob rests on a valve stem with a rubber grommet at the base. This design prevents liquid spills from dripping into the controls below the burners.

CONTINUOUS **GRATES**

The continuous low-profile cast iron grates of your gas cooktop are designed for a close fit. This enables you to move pans easily from one burner to another without having to lift the pan or have it tip over between the grates. Each grate sets securely on dimples on each corner of the burner pan. Refer to the illustration below.

For the 30" (762) and 36" (914) gas cooktops, the continuous grates are interchangeable with each other, with the exception of the single grate on the 36" (914) cooktop.

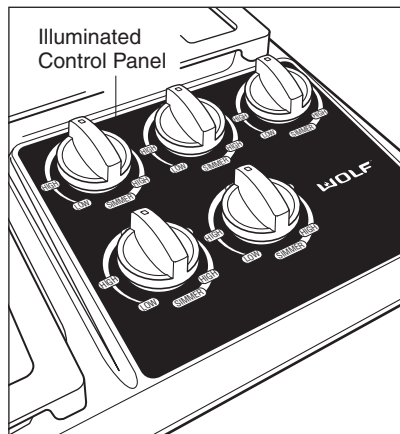

Control panel for Model CT36G

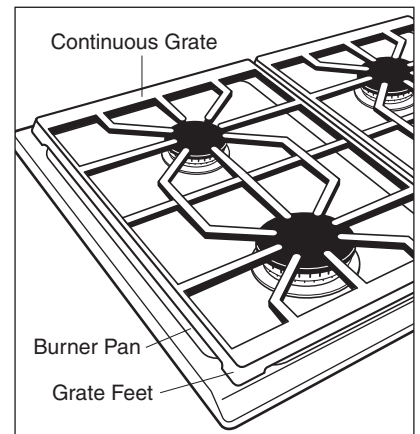

Continuous grates



SURFACE BURNERS

A spark electrode ignites each surface burner. This control eliminates the need for continuous open flame pilots. For added safety and convenience, each burner is designed with an electronic reignition system. This feature enables any burner to relight automatically in the event it is accidentally extinguished.

A distinguishing feature of Wolf’s low Btu/hr control is its constant, low heat output without continuous ignitions. The flame diameter remains full size; only the heat output is lowered. This patented dual-stacked burner design makes it possible to enjoy cooking at full flame as well as maintain control while simmering at the lowest flame setting.

DUAL-STACKED BURNER ASSEMBLY

The unique dual-stacked burner design of your gas cooktop combines all of the burner parts in one assembly.

After cleaning or removing burner parts for any reason, it is extremely important that you reassemble burners correctly.

The burner cap has a groove in the bottom, which allows the cap to fall into place when moved around the top of the burner. The cap should be flat relative to the burner when in the proper orientation. Failure to do this will result in a poor flame. Refer to the illustration below.

⚠ CAUTION

Failure to position the burner parts correctly could cause flames or gas to escape, causing heat damage to your cooktop, or burn between parts, resulting in poor combustion.

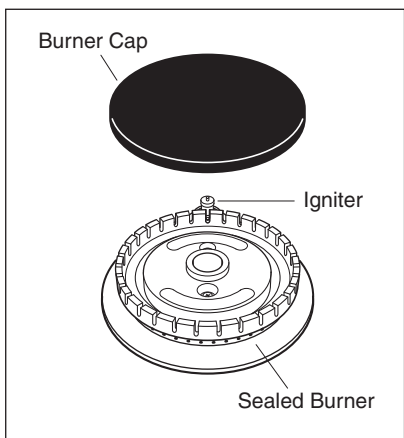

Dual-stacked burner assembly

Dimensions in parentheses are in millimeters unless otherwise specified.

BEFORE USING YOUR COOKTOP

Before using for the first time, you should clean your gas cooktop thoroughly with hot water and a mild detergent. Rinse and dry with a soft cloth. This removes any residual oil and grease left on the surface from the manufacturing process. Apply a stainless steel polish to protect the finish and add luster. Refer to Care Recommendations on page 15.

IMPORTANT NOTE: Before using your gas cooktop, check that the surface burner caps are positioned correctly.

CONTROL KNOB OPERATION

Each burner has full flame and full simmer capabilities. Knobs are designed as two-tiered "push-to-turn" knobs. One tier is used for HIGH through LOW flame settings; the second tier controls SIMMER settings. Refer to the illustration below. Although this is a child-safe design, children should never be left unattended in the kitchen when the cooktop is in use.

To light a burner, push down and turn the corresponding control knob counterclockwise to the HIGH setting. You will hear a clicking sound and see the burner ignite. Once the burner is lit, continue turning the knob counterclockwise to any one of the settings—HIGH through LOW.

To select a SIMMER setting, turn the burner knob to the LOW setting; you will feel a stop detent in the knob rotation. Push down on the knob, continuing to turn it counterclockwise. This moves it to the second tier. Now, select any variation within the SIMMER flame settings—HIGH through LOW.

⚠ CAUTION

Never leave pans on a HIGH setting unattended. Be particularly cautious when cooking food in fat or grease. It can become hot enough to ignite.

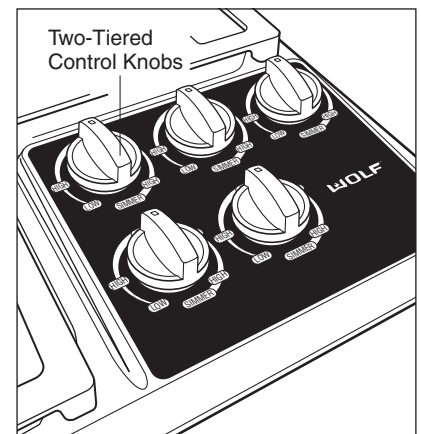

Two-tier burner control knobs



FLAME HEIGHT AND APPEARANCE

Select a flame that is just high enough to maintain the desired cooking speed and is sized to fit the base diameter of the pan. Never extend the flame beyond the base of the pan.

The flame on natural gas should be blue with a deeper blue core. There should be minimal trace of a yellow flame. A yellow flame indicates an improper mixture of air and gas or impurities in the gas supply to the range. If this occurs consistently, call a Wolf authorized service center to adjust the mixture. With LP gas, some yellow tipping to the flame is acceptable and may not require an adjustment. Refer to the illustration below.

POWER OUTAGE

In case of a power outage, you can relight the surface burners manually. Turn the control knob to HIGH, then use a minimum 6" (152) igniter to manually light the burner. Refer to the illustration below.

⚠ CAUTION
 As a safety measure, it is important to light each burner individually.

TEMPERATURE SETTING GUIDE

SETTING	USES
LOW Simmer	Melting, holding chocolate Melting butter Heating, holding delicate sauces Warming foods
HIGH Simmer	Melting large quantities Simmering sauces Steaming rice
LOW to MEDIUM Heat	Frying eggs Heating milk, cream sauces and soups, gravies and puddings Panfrying Simmering large quantities Boiling vegetables in water
MEDIUM to HIGH Heat	Sautéing Browning Braising Fast boiling large quantities Quick frying
HIGH Heat	Boiling water Heating broth soups, stocks Deep fat frying (to heat cooking oil only)

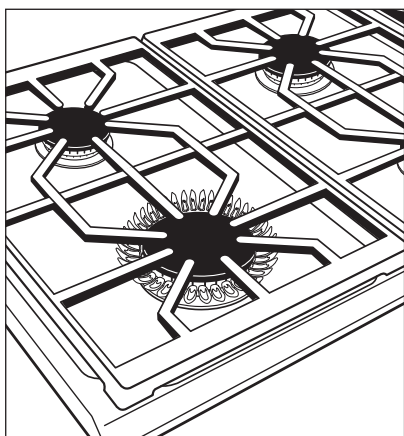

Large burner on HIGH setting

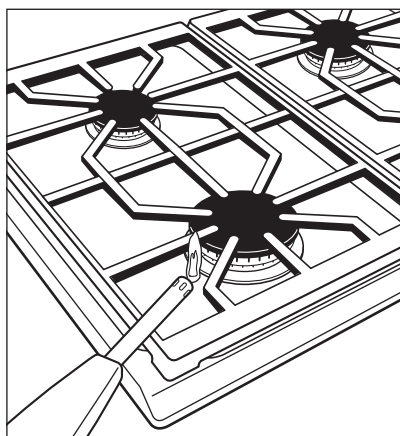

Manually relighting the burner

Dimensions in parentheses are in millimeters unless otherwise specified.



VENTILATION OPTIONS

IMPORTANT NOTE: It is recommended that you operate the Wolf gas cooktop with either a Wolf cooktop ventilation hood, downdraft system or Pro ventilation hood. Contact your Wolf dealer for details.

- **Cooktop Wall Hood** – 30" (762) or 36" (914) widths in classic stainless steel.
- **Cooktop Island Hood** – 42" (1067) width in classic stainless steel.
- **Downdraft Ventilation System** – 30" (762), 36" (914) or 45" (1143) widths, with top cover and control panel in classic, platinum and carbon stainless steel finishes (45" downdraft available in classic finish only).
- **Pro Wall Hood** – 22" (559), 24" (610) or 27" (686) depths and 30" (762) to 66" (1676) widths in classic stainless steel.
- **Pro Island Hood** – 36" (914) to 66" (1676) widths in classic stainless steel.
- **Pro Hood Liner** – available in widths to accommodate 30" (762) to 60" (1524) hood shells.

All hoods have welded seams, sealed halogen lighting and removable, dishwasher-safe filters.

COOKWARE SELECTION

For best results, we recommend medium- to heavy-weight pans that have a flat base, metal handle and a good-fitting cover.

Look for pans that are made of materials with good heat conductivity, such as aluminum and copper. These metals are sometimes found "sandwiched" between the inner and outer layers of the pan. If present, whether visible from the outside or not, they aid in evenly conducting heat.

Use the following guidelines when selecting cookware:

- Griddles or open roasters that span two burners are suitable, providing they are not warped.
- When a large pan is centered over a burner, the diameter should not exceed 10" (254).
- When using pans made of cast iron, enameled steel or glass ceramic, or coated with a nonstick finish, select lower flame settings. High heat applied to such materials will cause "hot spots," scorching and burning.
- Cover pans while cooking; covers improve cooking efficiency. Water boils faster, using less fuel, and the kitchen stays cooler.
- Select high-sided (deep) pans rather than ones with very wide bases and low sides. High sides will minimize liquids boiling over the pan.
- Pans with oversize bases that extend beyond the cooktop frame **should not** be used. On HIGH settings, heat may be trapped beneath the pan, causing permanent damage to the surface finish.
- Use the front burners for larger pans. The pans are easier to handle, especially when hot.
- Use a wok with a flat bottom.



CARE RECOMMENDATIONS

COMPONENT	CARE RECOMMENDATION
Exterior Surface Stainless steel	CAUTION: Make sure the gas cooktop is off and all surfaces are cool before cleaning any part of the cooktop.
Burner Pan Stainless steel	<p>Although stainless steel is resistant to most stains, it is not totally impervious to damage. Salt and some cooking liquids may pit and stain the surface. Always remove these spills immediately.</p> <p>General care: Use a clean cloth or sponge; wipe with warm water and a mild dish detergent. Rinse and dry immediately.</p> <p>Exterior finish: To clean the exterior of a classic or platinum stainless steel model, use a soft, nonabrasive stainless steel cleaner like Signature Polish (see side note) and apply with a soft, lint-free cloth.</p> <p>Spray degreasers: Spray on a cloth and wipe surface to remove fingerprints and greasy spatters. Buff dry immediately to avoid streaking.</p> <p>Hard water stains: Use white vinegar and water.</p> <p>Do not use abrasive cleaners (e.g. Comet); they will permanently scratch the surface. Do not use steel wool pads.</p>
Burner Cap Porcelain enamel	<p>Cool first. Wash in warm water and liquid detergent or mild abrasive cleaner.</p> <p>Foods high in acid or sugar content, such as milk, tomatoes, sauerkraut, fruit juices or pie filling, may pit or craze the surface. Remove as soon as possible before heating again.</p> <p>Never wipe a warm or hot porcelain surface with a damp sponge; it may cause chipping or crazing (tiny hairlike cracks).</p>
Burner Grates Porcelain-coated cast iron	<p>Remove from cooktop and place on a flat surface near the sink to clean.</p> <p>Nonabrasive cleaners: Hot water and liquid detergent or a paste of baking soda and water; use a plastic pad or sponge.</p> <p>Mild abrasive and abrasive cleaners: Use sparingly.</p>
Control Knobs Chrome-plated	<p>To remove, slip the edge of a dish towel under the knob; pull edges together. Using the towel for leverage, lift up, pulling the knob off the valve stem.</p> <p>General care: Wipe each knob with damp cloth and mild soap and water; rinse and dry. Never soak or use abrasive cleaners; they will scratch the finish and remove the markings.</p>
Control Panel Tempered glass	Spray cleaners: Removes fingerprints and greasy food soils. Spray first on a cloth before wiping panel.
Spark Igniters Ceramic	Keep dry; never spray water or cleaner directly on the igniter. When cleaning around the surface burner, be careful that the cloth does not catch on the igniter and damage it.

SIGNATURE
POLISH

Signature Polish is available from Signature Limited Laboratory, P. O. Box 13436, Dayton, Ohio 45413-0436, or call 877-376-5474 (toll free).

Dimensions in parentheses are in millimeters unless otherwise specified.

**COOKTOP** CLEANING TIPS

- Wait until surfaces are cool before cleaning.
- For best results, wipe up spills and splatters as they occur and immediately after the cooktop has cooled. If splatters are allowed to cook on, they may permanently damage or stain the finish.
- If in doubt about using one of your cleaners, check the label. To check if it is safe to use on your cooktop, try a small amount on an inconspicuous area using very light pressure.
- Use caution when spraying cleaners. Some contain caustic ingredients that can damage adjacent parts and finishes. Protect the adjacent parts by masking them off so that the overspray is contained to the finish being cleaned.
- Do not spray cleaners on electrical controls, igniters, wires or knob valve stems.

SIGNATURE
POLISH

Signature Polish is available from Signature Limited Laboratory, P. O. Box 13436, Dayton, Ohio 45413-0436, or call 877-376-5474 (toll free).

STAINLESS STEEL FINISH

- For the classic or platinum stainless steel exterior finish, use a soft, nonabrasive stainless steel cleaner like Signature Polish (see side note) and apply with a soft lint-free cloth.
- To bring out the natural luster of both finishes, lightly wipe the surface with a water-dampened microfiber cloth, followed with a dry microfiber cloth. All work should follow the grain direction of the finish. Better results are obtained by keeping the cloth in continuous contact with the metal.
- Under no circumstances should you use a metallic or highly abrasive cleaner or cloth, as this will permanently scratch the surface.

⚠ WARNING

DO NOT use abrasive cleaners on your cooktop (e.g. Comet); they will permanently scratch the surface.

**TROUBLESHOOTING** GUIDE

PROBLEM	POSSIBLE SOLUTION
Burner flame does not burn evenly	Reposition the burner cap of the stacked sealed burner assembly as described on page 11.
Food boils or burns in one area of the pan and not the other	<p>Placement of pan on the grate is not centered above the burner.</p> <p>Pan material does not conduct heat evenly.</p> <p>Base of pan is warped and does not rest flat on the grate or handle of pan is too heavy and tips pan toward handle.</p> <p>Countertop or cooktop cabinet is not level.</p>
Burner fails to ignite	<p>Ceramic igniter is damp from a spillover or spray cleaner. Allow ceramic to dry out completely.</p> <p>Burner head ports are blocked. Use a straightened, metal paper clip to open the blockage.</p> <p>If a GFCI circuit is used, check to see if it has been tripped.</p>
Burners extinguish themselves when using more than one large roaster or griddle simultaneously	Good gas combustion requires the correct amount of airflow to maintain the flame. Using two oversize pans simultaneously restricts air movement.
Food boils out of the pan and overflows into the burner pan	Heat setting is too high or pan size is too small for its contents.
Water does not come to a boil fast enough	<p>Water temperature is colder than usual.</p> <p>Cover pan for most efficient use of the high setting.</p> <p>Diameter of pan is too large or base of pan is warped.</p>
Food cooks too slowly when sautéing	<p>Too much food is added at one time; reduce amount of food and sauté in batches.</p> <p>Size of food pieces is too large or temperature of food is colder than usual.</p> <p>Pan does not conduct heat evenly.</p>
Simmer setting does not maintain constant surface bubbles	Delicate foods may need a lower simmer setting so that scorching does not occur.

**SERVICE** INFORMATION

When requesting information, literature, replacement parts or service, always refer to the model and serial number of your cooktop. Both numbers are listed on the product rating plate located on the underside of the cooktop. Refer to the illustration on page 3. Record the rating plate information below for future reference.

CONTACT INFORMATION

Wolf Customer Service:
800-332-9513

Website:
wolfappliance.com

Model Number _____

Serial Number _____

Installation Date _____

Wolf Authorized Service Center and Phone

Wolf Dealer and Phone

BEFORE CALLING FOR SERVICE

Before calling your Wolf authorized service center, refer to the Troubleshooting Guide on page 17. Check the household fuse or circuit breaker to see if it has been blown or tripped and that the electrical connection to the appliance has not been disconnected. A power outage may also have caused a disruption in service.

PRODUCT REGISTRATION

Register your new Wolf product today so that we may ensure your satisfaction. You may register by one of the following options:

- 1)** Mail in the completed Wolf Product Registration Card.
- 2)** Register online at **wolfappliance.com**.
- 3)** Register by phone by calling the Wolf Customer Service Department at **800-332-9513**.

The model and serial numbers of your appliance are printed on the enclosed Wolf Product Registration Card. If you provide us with your e-mail address, we will send you exciting new product updates and recipes as they become available, along with information on special events.

The information and images are the copyright property of Wolf Appliance Company, Inc., an affiliate of Sub-Zero Freezer Company, Inc. Neither this book nor any information or images contained herein may be copied or used in whole or in part without the express written permission of Wolf Appliance Company, Inc., an affiliate of Sub-Zero Freezer Company, Inc.

© Wolf Appliance Company, Inc. all rights reserved.

WOLF APPLIANCE PRODUCTS LIMITED WARRANTY

RESIDENTIAL USE ONLY

FULL TWO YEAR WARRANTY*

For two years from the date of original installation, your Wolf Appliance product warranty covers all parts and labor to repair or replace any part of the product that proves to be defective in materials or workmanship. All service provided by Wolf Appliance Company under the above warranty must be performed by a Wolf Appliance authorized service center, unless otherwise specified by Wolf Appliance Company. Service will be provided in the home during normal business hours.

LIMITED THIRD THROUGH FIFTH YEAR WARRANTY

From the third through fifth year from the date of original installation, Wolf Appliance Company will repair or replace the following parts that prove to be defective in materials or workmanship. Labor to remove and replace defective parts is not covered. Wolf Appliance Company recommends that you use a Wolf Appliance authorized service center to perform such service.

Gas Burners (excluding appearance), Electric Heating Elements, Blower Motors (vent hoods),
Electronic Control Boards, Magnetron Tubes and Induction Generators

LIMITED LIFETIME WARRANTY

For the life of the product, Wolf Appliance Company will repair or replace any BBQ body or BBQ hood that rusts through due to defective material or workmanship. Labor to remove and replace defective parts is not covered. Wolf Appliance Company recommends that you use a Wolf Appliance authorized service center to perform such service.

TERMS APPLICABLE TO EACH WARRANTY

The warranty applies only to products installed for normal residential use. The warranty applies only to products installed in any one of the fifty states of the United States, the District of Columbia or the ten provinces of Canada. This warranty does not cover any parts or labor to correct any defect caused by negligence, accident or improper use, maintenance, installation, service or repair.

THE REMEDIES DESCRIBED ABOVE FOR EACH WARRANTY ARE THE ONLY ONES THAT WOLF APPLIANCE COMPANY, INC. WILL PROVIDE, EITHER UNDER THIS WARRANTY OR UNDER ANY WARRANTY ARISING BY OPERATION OF LAW. WOLF APPLIANCE COMPANY, INC. WILL NOT BE RESPONSIBLE FOR ANY CONSEQUENTIAL OR INCIDENTAL DAMAGES ARISING FROM THE BREACH OF THIS WARRANTY OR ANY OTHER WARRANTY, WHETHER EXPRESS, IMPLIED OR STATUTORY.

Some states do not allow the exclusion or limitation of incidental or consequential damages, so the above limitation or exclusion may not apply to you. This warranty gives you specific legal rights and you may also have other legal rights that vary from state to state.

To receive parts and/or service and the name of the Wolf Appliance authorized service center nearest you, contact Wolf Appliance Company, Inc., P.O. Box 44848, Madison, Wisconsin 53744; check the Locator section of our website, wolfappliance.com, or call 800-332-9513.

* Stainless Steel (classic, platinum and carbon) doors, panels and product frames are covered by a limited 60 day parts and labor warranty for cosmetic defects.





WOLF APPLIANCE COMPANY, INC. P.O. BOX 44848 MADISON, WI 53744 800-332-9513 WOLFAPPLIANCE.COM

WOLF[®]

808733

7/2006