

This Owner's Manual is provided and hosted by [Appliance Factory Parts](#).



MARGARITAVILLE DM3000 SERIES Owner's Manual

[Shop genuine replacement parts for MARGARITAVILLE
DM3000 SERIES](#)



[Find Your MARGARITAVILLE Small Appliance Parts - Select From 3 Models](#)

----- Manual continues below -----

THE NAVIGATOR



Tahiti™

FROZEN CONCOCTION MAKER™

The Best Margaritas Come From Margaritaville®



Model DM3000 Series User Manual

We know you are excited to start making fabulous Frozen Concoctions... so please take a moment to read these important safeguards and instructions before you begin. Be safe. Have fun. And enjoy!

IMPORTANT SAFEGUARDS

WHEN USING ELECTRICAL APPLIANCES, BASIC SAFETY PRECAUTIONS SHOULD ALWAYS BE FOLLOWED, INCLUDING THE FOLLOWING:

1. **READ ALL INSTRUCTIONS BEFORE USING.**
2. To protect against electric shock, do not immerse appliance, cord or plug in water or other liquids.
3. Close supervision is necessary when any appliance is used near children. This appliance should not be used by children.
4. Unplug from outlet when not in use, before putting on or taking off parts, and before cleaning.
5. Flashing light indicates ready to operate. Avoid any contact with blades or moveable parts.
6. Do not operate any appliance with damaged cord or plug, after the appliance malfunctions, or is dropped or damaged in any manner. Contact 1-877-689-2737 for customer service.
7. Do not use outdoors.
8. Do not let cord hang over the edge of a table or counter or touch hot surfaces, including the stove.
9. Keep hands and utensils out of container while blending and/or ice shaving to reduce risk of severe injury to persons or damage to the unit. A rubber spatula may be used but must be used only when the appliance is not running.
10. **BLADES ARE SHARP**; handle with caution. Sharp blades are located in the main **Ice Reservoir** as well as in the bottom of each **Blending Jar**.
11. Always operate appliance with **Jar Lid** and **Ice Reservoir Lid** in place.
12. The use of attachments, including canning jars, not recommended by the manufacturer may cause a risk of injury to persons.
13. Do not use broken or cracked **Blending Jar** or **Ice Reservoir**.

14. To reduce risk of injury to persons, never place a **Blending Blade Assembly** on the base of a **Blending Station** without a **Blending Jar** properly attached.
15. Do not leave appliance unattended while it is operating.
16. To disconnect, turn control to Off, then remove plug from wall outlet.
17. Do not use appliance for other than intended use.
18. Never place fingers or other utensils into feed or discharge areas.
19. Check **Ice Reservoir** for presence of foreign objects before using.
20. Be certain the **Jar Lid(s)** and **Ice Reservoir Lid** are securely locked in place before operating appliance.
21. Do not blend hot liquids.

NOTE: NEVER SHAKE OR REMOVE BLENDER JAR DURING OPERATION AS JAR BLADE ASSEMBLY CAN GET DAMAGED.

SAVE THESE INSTRUCTIONS FOR HOUSEHOLD USE ONLY

Polarized Plug

This appliance has a polarized plug (one blade is wider than the other). As a safety feature, this plug will fit in a polarized outlet only one way. If the plug does not fit fully into the outlet, reverse the plug. If it still does not fit, contact a qualified electrician. Do not attempt to defeat this safety feature.

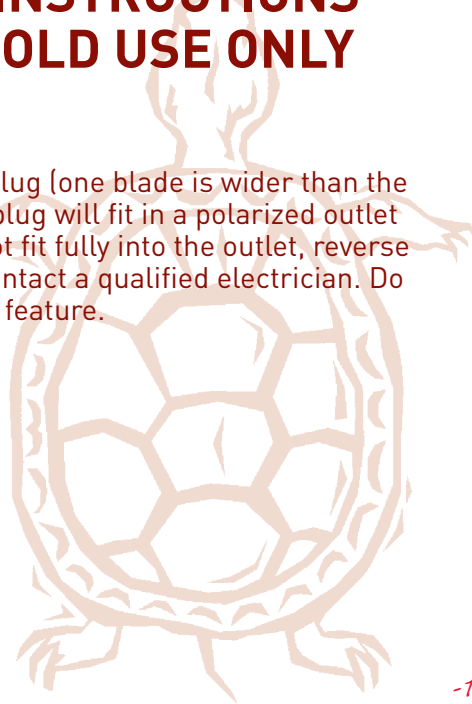



WELCOME TO MARGARITAVILLE®

*Margaritaville® isn't a place,
it's a state of mind . . . it is an escape from the everyday!
The Margaritaville® "Tahiti™" Frozen Concoction Maker™
makes it a short trip from here to there, where you can put on
your no-worries attitude and enjoy a perfectly prepared,
restaurant-style frozen drink.*

The "Tahiti™" instruction manual was developed to help quickly familiarize you with your Frozen Concoction™ Maker. You're just a few short steps away from Margaritaville®, enjoying a perfectly prepared frozen drink. To learn more about Margaritaville® products, please visit us at www.margaritavillecargo.com.

TABLE OF CONTENTS

Important Safeguards

- p.3, 4* Parts List
- p.4* The Control Panel
- p.5* Making Frozen Drinks
- p.6* Recipes
- p.7* Adding Drink Ingredients
- p.7* Starting the Automated Shave-n-Blend Cycle
- p.8* Perfecting you frozen Concoction
- p.10* Cleaning & Maintenance
- p.12* Troubleshooting
- p.13* Warranty Information

FROZEN CONCOCTION MAKER™

PARTS LIST

1. **Ice Reservoir Lid** – Covers the Ice Reservoir.
2. **Ice Reservoir** – Holds the ice for making frozen drinks.
3. **Hopper Cover** – Keeps ice contained in the hopper.
4. **Integrated Thumbscrew Lock with Shaving Paddle assembly** – Moves ice across the Shaving Blade.
DO NOT SEPARATE INTEGRATED THUMBSCREW FROM ICE PADDLE.
5. **Ice Hopper** – Holds the Ice for shaving.
6. **Ice Shaving Blade with deflector** – Shaves ice.
7. **Shaving Blade Assembly Nut** - Holds Shaving Blade in place.
8. **Rotating Ice Chute** – Rotates to direct ice from Ice Hopper into Blending Jars.
9. **Blending Station (3)** – Three stations available to create frozen drinks.
10. **Blending Base** – Holds the three Blending Jars securely in place.
11. **Control Panel** – Contains the controls to make frozen drinks.
12. **Recipe Drawer** – Stores drink recipe card.

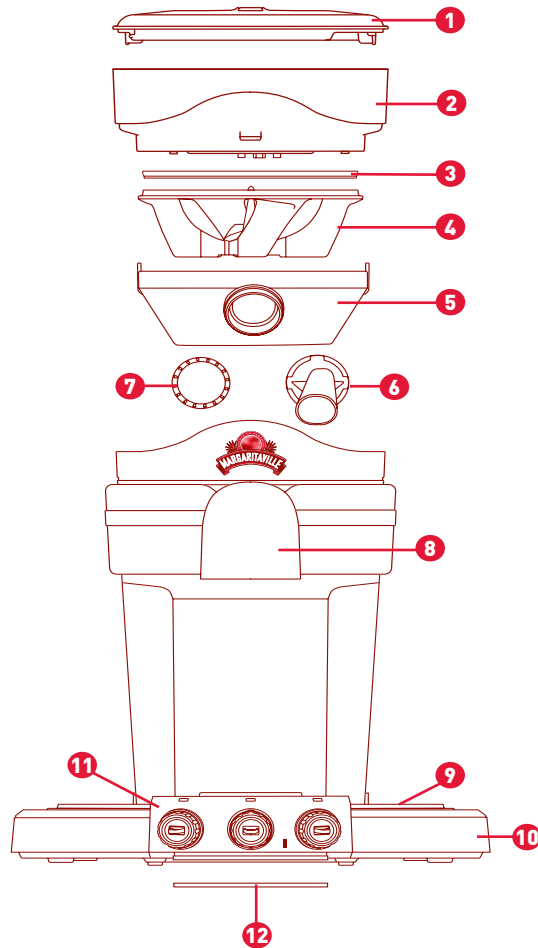

13. **Jar Lids (3)** – Seals the Blending Jars.

14. **Plastic Jars (3)** – To blend frozen drinks; maximum capacity of 24 oz. each.

15. **Blending Jar Sealing Rings (3)** – Seals the Blending Jars and Blending Base.

16. **Blending Blades (3)** – Blends ice and ingredients to create frozen drinks.

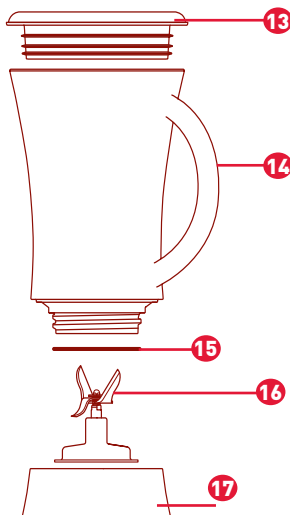
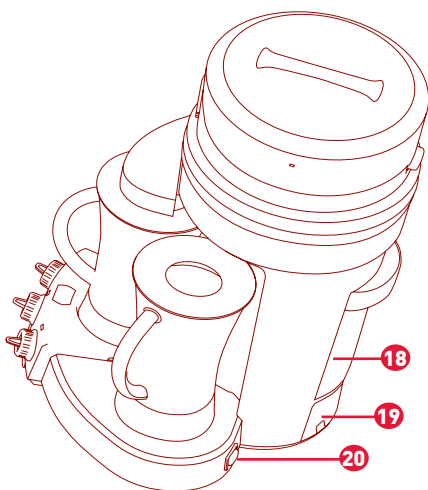

17. **Blending Jar Bases (3)** – Secures the blending blade to the blender jar.

18. **Ice Melt Reservoir** – Holds melted ice run off.

19. **Power Cord Storage Door** – Covers power cord storage area.

20. **On/Off Power Switch** – Turns the unit on or off.

TAHITI™ DM3000 SERIES CONTROL PANEL

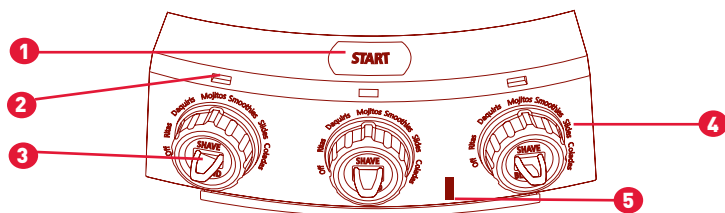

1. **START** Button – Begins and stops the automatic Shave-n-Blend™ cycle.

2. **White LED Lights (3)** – Indicates that a Blending Jar is seated firmly in place and a drink has been selected for that Blending Station.

NOTE: LED LIGHT WILL BLINK WHEN THE SHAVE-N-BLEND™ OR MANUAL CYCLE IS RUNNING AT THAT STATION.

3. **Manual SHAVE/BLEND** Toggle Switches (3) – Used to manually operate ice shaver & blender to customize the thickness of each Blender Jar of drinks.

4. **DRINK SELECTION** Rotary Switches (3) – Used to select the type of drink to be made at each Blending Station.

5. **Power Indicator Light** – Flashes when unit is plugged in and power switch is on to indicate unit is ready for use.

NOTE: FLASHING LIGHT INDICATES READY TO OPERATE. AVOID ANY CONTACT WITH BLADES OR REMOVABLE PARTS.

MAKING FROZEN DRINKS

And now for the fun part! You are just a few short steps away from enjoying your perfectly blended, restaurant-style frozen drink. Before you use your Frozen Concoction Maker™ for the first time, we recommend that you read through these simple steps to get to know the features of this unit. Before you know it, you'll be whipping up perfect drinks for your guests!

PREPARING THE UNIT FOR USE

1. Place the unit on a clean, dry, flat surface.
2. If Ice Reservoir is not yet installed, place the Ice Reservoir on the unit front first, then push down firmly on the back to click it into place. (Figure 1)

NOTE: IF THE ICE RESERVOIR IS NOT SEATED FIRMLY IN PLACE, THE SHAVER UNIT WILL NOT OPERATE.

3. Remove the Power Cord Storage Door at the back of the unit by pushing down on the release tab. Remove the Power Cord and plug into a standard 120-volt socket (Figure 2). Replace the Power Cord Storage Door, and position the Power Cord in the slot provided.



Figure 1



Figure 2

ADDING ICE TO THE ICE RESERVOIR

4. Remove the Ice Reservoir Lid by rotating it counter-clockwise and lifting up. (Figure 3)
5. Fill the Ice Reservoir with ice cubes to the "Ice Level" Line (Figure 4).

NOTE: FOR BEST RESULTS, USE ICE THAT HAS BEEN OUT OF THE FREEZER FOR 10 TO 15 MINUTES.

6. Replace the Ice Reservoir Lid by rotating it clockwise back into place. (Figure 5)

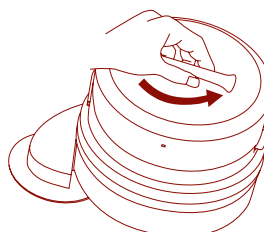

Figure 3

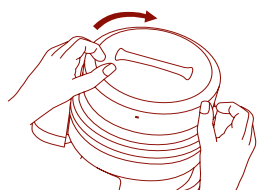

Figure 5



Figure 4

THE BEST CONCOCTION RECIPES

Margaritas (Ritas)-24 fluid oz.

Ingredients	fl oz	ml
Margaritaville® Gold Tequila	2 ² / ₃	80
Triple Sec	² / ₃	20
Lime Juice	1 ¹ / ₃	40
Orange Juice	1 ¹ / ₃	40
Margaritaville® Margarita Mix	2 ² / ₃	80

Frozen Mojito Slush-24 fluid oz.

Ingredients	fl oz	ml
Sugar	2	60
Mint Leaves	8 to 10 leaves	
Soda Water	3	90
Light Rum	2 ² / ₃	80
Sweetened Lime Juice	2	60

Strawberry Daiquiris (Daiquiris)-24 fluid oz.

Ingredients	fl oz	ml
Light Rum	3	90
Sugar	2Tbs	30
Cranberry Juice	6	180
Frozen Strawberries	1 ¹ / ₃ C	315

Piña Coladas (Coladas)-24 fluid oz.

Ingredients	fl oz	ml
Rum	2	60
Cream of Coconut	2 ² / ₃	80
Pineapple Juice	2 ² / ₃	80

Mudslides (Slides)-24 fluid oz.

Ingredients	fl oz	ml
Bailey's Irish Cream	2 ² / ₃	80
Kahlua	2 ² / ₃	80
Vanilla Ice Cream	8Tbs	118
Chocolate Syrup	1 ¹ / ₃	40

Smoothies-24 fluid oz.

Ingredients	fl oz	ml
Raspberry Sherbert Ice Cream	8Tbs	118
Pineapple Juice	6	180
Fresh Strawberries	1C	236

C = cups Tbs = tablespoons

ADDING DRINK INGREDIENTS TO THE BLENDING JARS

- Lift and remove the three Blending Jars

NOTE: AT THE CENTER BLENDING STATION, THE ICE CHUTE IS SPRING-LOADED AND WILL RETRACT WHEN REMOVING THE BLENDING JAR.

- Remove the lid of each Blending Jar.
- Pull out the Recipe Drawer to refer to drink recipes.
- Add ingredients to each Blending Jar based on the type of drinks you will be making at each Blending Station to be used for this cycle.

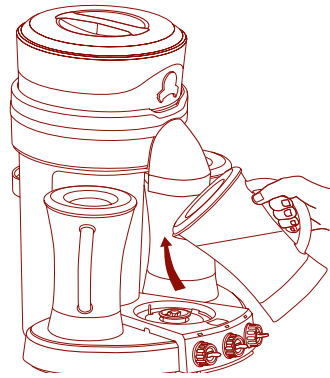

NOTE: DO NOT OVERFILL INGREDIENTS AS IT CAN CAUSE OVERFLOW

- Turn the main On/Off Switch (located at the right back side of the unit) to the ON position. The main Power Indicator Light will illuminate and flashes.
- Replace each Blending Jar Lid, and return each Blending Jar to the respective Blending Station. Each jar can only be positioned in three orientations.

NOTE: FOR THE MIDDLE STATION, PUSH UP ON THE RETRACTING ICE CHUTE WITH THE BLENDING JAR TO SET IT INTO PLACE.

- For each Blending Station you are using for this cycle, rotate the Drink Selection switch to match the type of drink you have prepared. The White LED Light will illuminate for each active Blending Station.

NOTE: FOR ANY BLENDING STATIONS YOU ARE NOT USING IN THIS CYCLE, LEAVE THE ROTARY DRINK SELECTION SWITCH AT THE "OFF" SETTING (OR LEAVE JAR OFF THE BASE). THE BLENDING JAR DOES NOT NEED TO

NOTE: THE UNIT WILL AUTOMATICALLY DETECT HOW MANY BLENDING STATIONS ARE IN USE FOR EACH SHAVE-N-BLEND™ CYCLE AND WILL ROTATE ONLY TO THE BLENDING JARS THAT ARE ACTIVE.

STARTING THE AUTOMATED SHAVE-N-BLEND™ CYCLE

- Start the automatic Shave-n-Blend™ cycle by depressing the START button in front of the center Blending Station for at least half a second.

NOTE: A DELAY WAS ADDED TO RESTRICT ACCIDENTAL START.

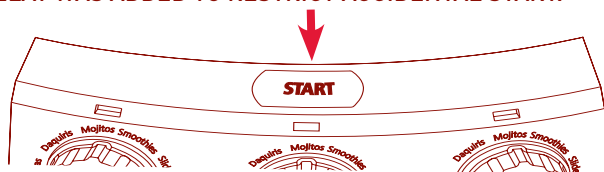

NOTE: NEVER SHAKE OR REMOVE A BLENDING JAR DURING OPERATION- BLADE ASSEMBLY WILL BE DAMAGED

15. If all three Blending Jars are in use for this cycle, the Ice Chute will rotate to the left jar and begin the auto Shave-n-Blend™ function. The unit will shave ice for the appropriate time (based on the Drink Selection type selected for that Blending Station). The blending will then start automatically.

NOTE: THE WHITE LED LIGHT WILL BLINK TO INDICATE WHEN EACH STATION IS IN USE.

16. When the left jar Shave-n-Blend™ function is completed, the Ice Chute will rotate to the center jar and begin the auto SHAVE-N-BLEND™ function based on the Drink Selection type selected for that Blending Station.

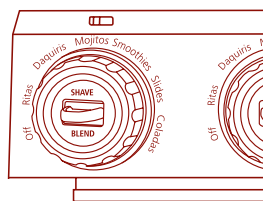

NOTE: AT ANY POINT DURING THE AUTOMATIC CYCLE, PRESS THE START BUTTON AGAIN TO CANCEL OPERATION.

17. When the second function is complete, the Ice Chute will rotate to the final right position and begin the auto SHAVE-N-BLEND™ function based on the Drink Selection type selected for that Blending Station.

NOTE: DO NOT REMOVE ANY OF THE BLENDING JARS FROM THEIR BLENDING STATIONS UNTIL THE SHAVE-N-BLEND™ FUNCTION HAS COMPLETED AT THAT STATION. ONCE AN INDIVIDUAL BLENDING STATION HAS COMPLETED. THE ICE CHUTE HAS ROTATED AWAY FROM THAT STATION, THE BLENDING JAR AT THAT STATION CAN BE REMOVED.

18. After the SHAVE-N-BLEND™ cycle is complete at all Blending Stations in use, an Orange light will illuminate to signal that the Ice Chute is about to move back into the center position.

NOTE: THE ORANGE LIGHT WILL FLASH FROM THE START BUTTON TO SIGNAL THAT THE ICE CHUTE IS GOING TO RETURN TO THE CENTER POSITION (HOME).

OPTIONAL: PERFECTING YOUR FROZEN CONCOCTIONS

USING THE MANUAL CYCLE

After the Shave-n-Blend™ cycle is finished, you can use the Manual Cycle to thicken or thin each Blending Jar of drinks to make them just how you like them.

TO THICKEN DRINKS:

- Depress the Manual SHAVE/BLEND toggle switch up or down of the desired Blending Station for at least two seconds and release if the Chute is not over the desired station. Ice Chute will rotate to the correct Blending Station and the Green LED light will flash as the Ice Chute is moving.

NOTE: IF THERE ARE NO ACTIONS AFTER THE ICE CHUTE HAS ARRIVED FOR 7 SECONDS AN ORANGE LIGHT WILL FLASH FROM THE START BUTTON FOR 3 SECONDS TO SIGNAL THAT THE ICE CHUTE IS GOING TO MOVE BACK TO THE CENTER (HOME) POSITION.

- When the Ice Chute stops over the desired Blending Station, push the toggle switch up to the SHAVE position to add more ice to the Blending Jar.
- Release the SHAVE switch when you have added the desired amount of ice.
- To blend in the additional ice, push the toggle switch down for that Blending Station until the desired consistency is achieved.
- To stop blending, release the toggle switch.
- You can also achieve thicker drinks by reducing any amount of liquid ingredients for the respective recipe.

TO THIN DRINKS:

- Depress the Manual SHAVE/BLEND toggle switch up or down of desired Blending Station for at least two seconds and release if the Chute is not over the desired station. The Ice Chute will rotate to the correct Blending Station and the Green LED light will flash as the Ice Chute is moving.

NOTE: IF THERE ARE NO ACTIONS AFTER THE ICE CHUTE HAS ARRIVED FOR 7 SECONDS AN ORANGE LIGHT WILL FLASH FROM THE START BUTTON FOR 3 SECONDS TO SIGNAL THAT THE ICE CHUTE IS GOING TO MOVE BACK TO THE CENTER (HOME) POSITION.

- When the Ice Chute is in position over the selected Blending Station, push the toggle switch down to BLEND until the desired consistency is achieved.
- To stop blending, release the toggle switch.
- You can also achieve thinner drinks by increasing any amount of liquid ingredients for the respective recipe.

SERVING YOUR FROZEN CONCOCTIONS

- To serve:
 - Lift and remove each Blending Jar.
 - Remove the Blending Jar Lid(s).
 - Pour and enjoy!
- To make more drinks, repeat from STEP 7, adding more ice to the Ice Reservoir as needed.
- During use, periodically check the Ice Melt Reservoir and empty as needed.



WHEN THE PARTY'S OVER

When you are finished using the Margaritaville® Frozen Concoction Maker™, follow these simple steps to remove any remaining ice from the Ice Reservoir.

- Place an empty Blending Jar in an available Blending Station, then hold that Station's toggle switch up on the SHAVE setting until the Ice Reservoir is empty.

WARNING: NEVER PLACE YOUR FINGERS IN THE ICE HOPPER. THE SHAVING BLADE IS VERY SHARP AND CAN CAUSE INJURY.

- Turn off the unit and unplug.
- Empty the Ice Melt Reservoir and wipe dry or allow to air dry.

CLEANING AND MAINTENANCE

IMPORTANT: Your Blending Jars, Shaving and Blending Blades are subject to wear during normal use. Always inspect for nicks, chips, or cracks. Always carefully inspect for broken, cracked, or loose blades. If any of the Jar or Shaving and Blending Blades are damaged, do not use. Call our toll-free customer service number, 1-877-689-2737, to obtain replacement parts.

1. Make sure unit is unplugged. Place on a clean dry surface. Turn the unit so the back is facing you. Remove the Ice Reservoir Lid by turning clockwise unlock position (Figure 1).

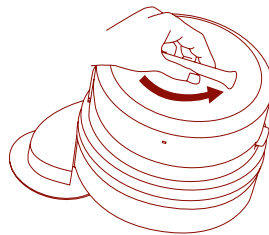

to the *Figure 1*

2. To remove the Ice Reservoir, push down on the **Ice Reservoir Release Button** (Figure 2). Lift the back of the Ice Reservoir and remove. This will expose the Hopper Cover, Shaving Paddle and Ice Hopper.

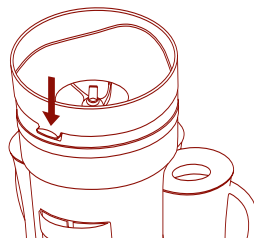

Figure 2

NOTE: THE SHAVING BLADE IS LOCATED INSIDE THE ICE HOPPER (FIGURE 3).

WARNING: SHAVING BLADES ARE SHARP. DO NOT PLACE FINGERS INSIDE THE ICE HOPPER NEAR THE SHAVING BLADE. BLADE IS SHARP; HANDLE WITH CAUTION.

3. To remove the hopper cover, simply lift up at either cut out area in front of the ice hopper release catches. (Figure 4)

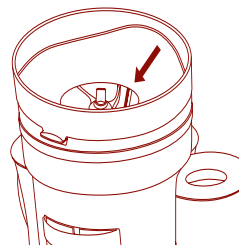

Figure 3

4. To remove the Shaving Paddle, unscrew the Shaving Paddle Thumb Screw counter-clockwise until loosened (**Do not separate from shaving paddle**), then remove the Shaving Paddle by lifting straight up (Figure 4), exposing the Ice Hopper and Shaving Blade. To reassemble, place the Shaving Paddle back into position, and screw down the Shaving Paddle Thumb Screw clockwise until tightened properly. (Figure 5).

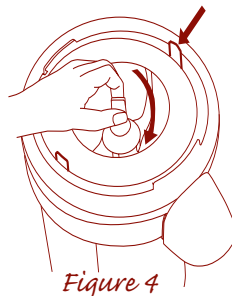

Figure 4

NOTE: THE ICE PADDLE IS KEYED TO MATCH THE SHAFT. MAKE SURE TO ALIGN PROPERLY TO ASSEMBLE.

NOTE: IF THE ICE PADDLE THUMBSCREW IS TOO TIGHT USE THE BOTTOM OF MEASURING CUP TO LOOSEN .

5. Press the two Ice Hopper release catches and lift the Ice Hopper to remove (Figure 6).

PLEASE FOLLOW THE INSTRUCTIONS BELOW TO SAFELY REMOVE THE SHAVING BLADE ASSEMBLY FROM THE ICE HOPPER.

6. Turn the Shaving Blade Assembly Nut counter clockwise (to the left), remove the Shaving Blade Assembly, rinse and dry prior to storage in a safe place (Figure 7).

BE SURE TO RINSE THE SHAVING BLADE AND DRY THOROUGHLY BEFORE STORING.

7. Carefully lift the Blending Jar(s) straight up to remove. At the center Blending Station, the Ice Chute is spring-loaded and can be pushed up. If the Blending Jar is not easily removed, rock gently and lift. Do not twist.
8. For each Blending Jar, turn the Blending Jar upside down and unscrew the Jar Base (counter-clockwise to the left). Carefully remove the Blending Blade, and Blending Blade Sealing Ring (Figure 8)

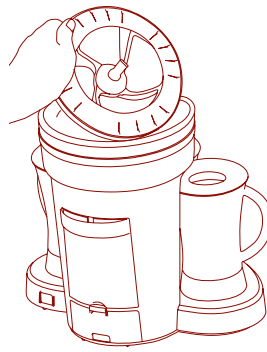

Figure 5

WARNING: THE BLENDING BLADE IS SHARP. HANDLE WITH CARE.

9. To remove the Ice Melt Reservoir hold the unit still and pull straight out on the handle (Figure 9).
10. Blending Jar Lids, Blending Jars, Blending Blade, Blending Blade Sealing Ring and Jar Bases can be safely washed in the top rack of your dishwasher. Use only top rack. Failure to do so can result in damage.
11. The Ice Reservoir Lid, Ice Melt Reservoir, Ice Reservoir, Shaving Paddle, Ice Hopper, Ice Deflector Blade Assembly, Shaving Blade and Ice Melt Reservoir are only exposed to ice and water, so they need only be rinsed with soap and warm water and allowed to air dry.
12. Inspect and clean under Ice Chute with a hot damp cloth.
13. Use a damp cloth to clean the outside of the unit.

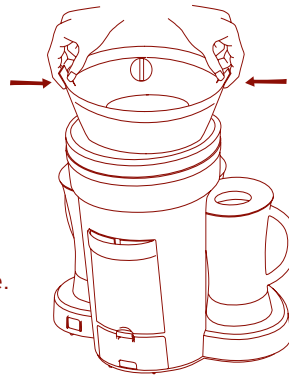

Figure 6

WARNING: UNPLUG UNIT BEFORE CLEANING.

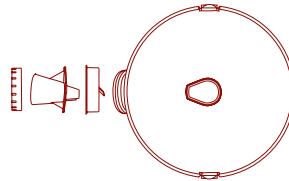

Figure 7

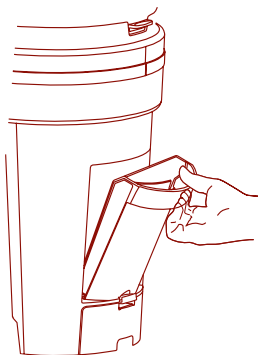

Figure 9

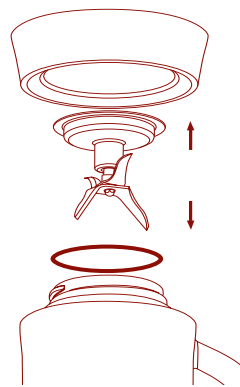

Figure 8

Troubleshooting

If the Power Indicator Light does not light:

Check that the unit is plugged into a working power outlet.

If liquid leaks from the base of the Blending Jar:

Remove it from the unit and check that the Blending Blade Sealing Ring is properly installed and that the Blending Jar Base is tightened.

If water leaks from the unit: Empty the Ice Melt Reservoir.

If the Blending Jar overflows during the Shave-n-Blend™ cycle:

Follow the drink recipes included in “making frozen drinks” section and make sure to not exceed the specified total volume.

If the Blending Jar will not sit on the Blending Station:

Remove it from the unit and check for ice on the Blending Base.
WARNING: unplug the unit before removing ice from the Blending Base.

If the unit is in fault mode (fast blinking red status compass rose indicator light): Check that the Ice Reservoir and Ice Reservoir Lid are properly installed and in the lock position.

If the drink is too watery: Make sure to follow the recipe guide or manually shave more ice until the desired consistency is achieved.

If the ice paddle thumbscrew is too tight, use the bottom of the measuring cup to loosen.

If the Ice Chute seems to be moving slowly or jamming, ensure not to overfill the Ice Reservoir above “ICE LEVEL”.

Do's and Don'ts

DO NOT Place fingers into the Blending Jar or Ice Hopper. The blades in this unit are sharp and could cause injury.

DO NOT place Blending Jar onto Blending Stations while motor is running. The spinning Blending Bases could damage the Blending Jars.

DO NOT twist Blending Jar when removing. Simply lift and remove. Twisting the Blending Jar could loosen the Blending Jar Base causing it to leak.

DO NOT put hot liquid into the Blending Jar. Hot liquids could be ejected during the blending process causing injury.

DO NOT place ice, frozen foods or very cold liquids into a Blending Jar which has come directly from a hot dishwasher. The sudden change in temperature could cause the Blending Jar to crack.

DO NOT place very hot liquids or foods into a Blending Jar that has come directly from the freezer. The sudden change in temperature could cause the Blending Jar to crack.

DO Follow the Cleaning and Maintenance instructions prior to your first use and after subsequent uses.

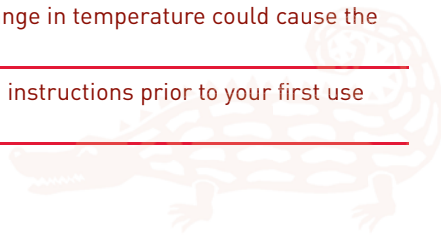

1 Year Limited Warranty

Sunbeam Products, Inc. doing business as Jarden Consumer Solutions or if in Canada, Sunbeam Corporation (Canada) Limited doing business as Jarden Consumer Solutions (collectively "JCS") warrants that for a period of one year from the date of purchase, this product will be free from defects in material and workmanship. JCS, at its option, will repair or replace this product or any component of the product found to be defective during the warranty period. Replacement will be made with a new or remanufactured product or component. If the product is no longer available, replacement may be made with a similar product of equal or greater value. This is your exclusive warranty. Do NOT attempt to repair or adjust any electrical or mechanical functions on this product. Doing so will void this warranty.

This warranty is valid for the original retail purchaser from the date of initial retail purchase and is not transferable. Keep the original sales receipt. Proof of purchase is required to obtain warranty performance. JCS dealers, service centers, or retail stores selling JCS products do not have the right to alter, modify or any way change the terms and conditions of this warranty.

This warranty does not cover normal wear of parts or damage resulting from any of the following: negligent use or misuse of the product, use on improper voltage or current, use contrary to the operating instructions, disassembly, repair or alteration by anyone other than JCS or an authorized JCS service center. Further, the warranty does not cover: Acts of God, such as fire, flood, hurricanes and tornadoes.

What are the limits on JCS's Liability?

JCS shall not be liable for any incidental or consequential damages caused by the breach of any express, implied or statutory warranty or condition.

Except to the extent prohibited by applicable law, any implied warranty or condition of merchantability or fitness for a particular purpose is limited in duration to the duration of the above warranty.

JCS disclaims all other warranties, conditions or representations, express, implied, statutory or otherwise.

JCS shall not be liable for any damages of any kind resulting from the purchase, use or misuse of, or inability to use the product including incidental, special, consequential or similar damages or loss of profits, or for any breach of contract, fundamental or otherwise, or for any claim brought against purchaser by any other party.

Some provinces, states or jurisdictions do not allow the exclusion or limitation of incidental or consequential damages or limitations on how long an implied warranty lasts, so the above limitations or exclusion may not apply to you.

This warranty gives you specific legal rights, and you may also have other rights that vary from province to province, state to state or jurisdiction to jurisdiction.

How to Obtain Warranty Service

In the U.S.A.

If you have any question regarding this warranty or would like to obtain warranty service, please call 1 877 689-2737 and a convenient service center address will be provided to you.

In Canada

If you have any question regarding this warranty or would like to obtain warranty service, please call 1 800 667-8623 and a convenient service center address will be provided to you.

In the U.S.A., this warranty is offered by Sunbeam Products, Inc. doing business as Jarden Consumer Solutions located in Boca Raton, Florida 33431. In Canada, this warranty is offered by Sunbeam Corporation (Canada) Limited doing business as Jarden Consumer Solutions, located at 20 B Hereford Street, Brampton, Ontario L6Y 0M1. If you have any other problem or claim in connection with this product, please write our Consumer Service Department.

PLEASE DO NOT RETURN THIS PRODUCT TO ANY OF THESE ADDRESSES OR TO THE PLACE OF PURCHASE.



DO NOT RETURN THIS PRODUCT TO THE PLACE OF PURCHASE

For product questions:

Sunbeam consumer services
U.S.A. 1-877-689-2737

www.margaritavillecargo.com

© 2008 Sunbeam Products, Inc. doing business as Jarden Consumer Solutions. All rights reserved.

ProductsMargaritaville® is a registered trademark of Margaritaville®.

Printed in China

P. N. 125215-004