

This Owner's Manual is provided and hosted by Appliance Factory Parts.

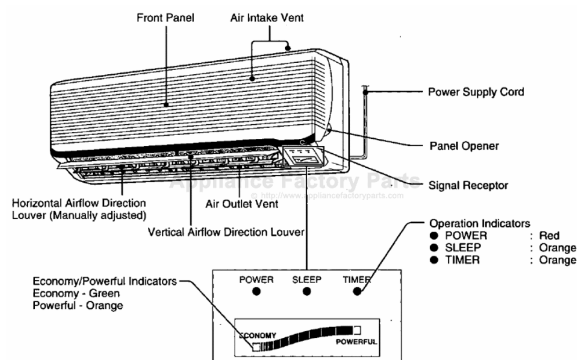

PANASONIC CS-C73K Owner's Manual

[Shop genuine replacement parts for PANASONIC CS-C73K](#)



[Find Your PANASONIC Air Conditioner Parts - Select From 287 Models](#)

----- Manual continues below -----

Operating Instructions

Room Air Conditioner

Models:
CS-C73K, CS-C93K, CS-C123K Series

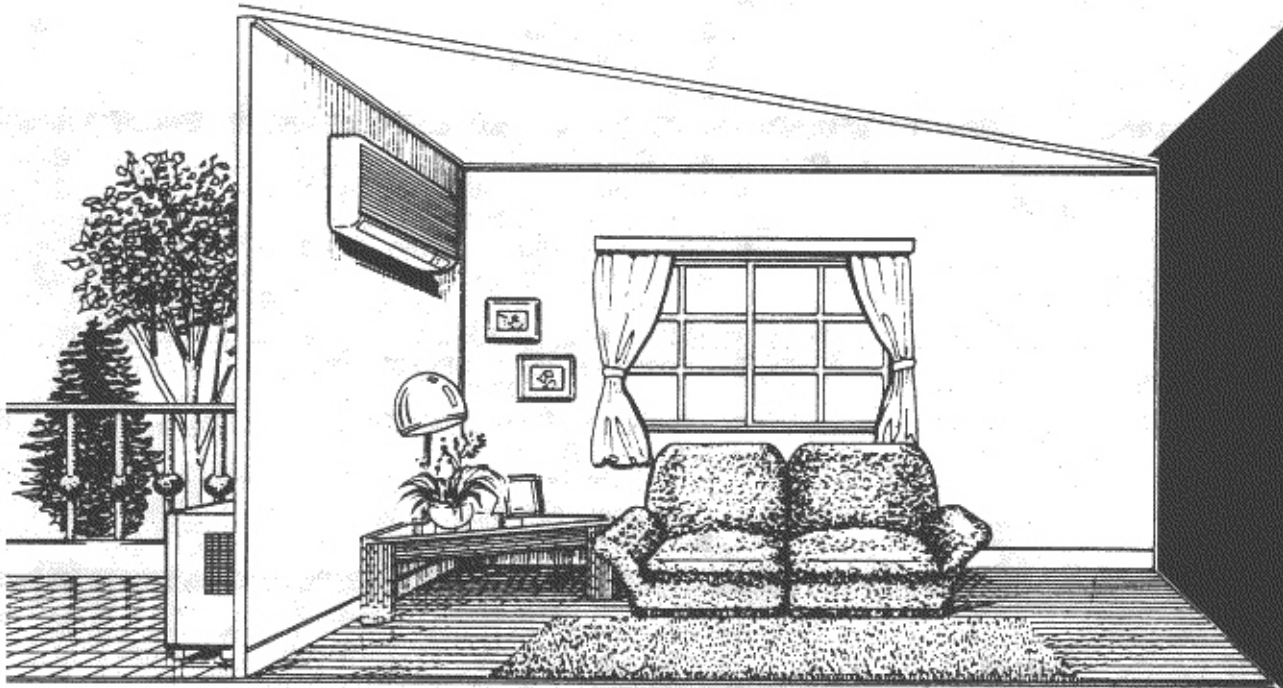

National / Panasonic

CONTENTS

1 Before use

- ▶ **FEATURES** 2
- ▶ **SAFETY PRECAUTIONS** 3 – 5
 - Installation Precautions
 - Operation Precautions
- ▶ **NAME OF EACH PART** 6 – 9
 - Indoor Unit
 - When the front panel is opened
 - Outdoor Unit
 - Accessories
 - Remote Control
 - When the remote control is opened
 - How to use the remote control
 - When the back cover is opened
- ▶ **PREPARATION BEFORE OPERATION** 10 – 11
 - Indoor unit
 - Remote Control
 - Inserting batteries
 - Setting the clock
 - About the batteries

2 How to use

- ▶ **HOW TO OPERATE** 12 – 13
 - Automatic • Cooling • Soft Dry • Fan
 - Operation details
 - Adjusting Airflow Direction and Fan Speed
 - Operation details
- ▶ **SETTING THE TIMER** 14 – 15
 - Recommended Setting of Timer
- ▶ **CONVENIENCE OPERATION** 16 – 17
 - Sleep Mode
 - Operation details
 - Economy or Powerful Mode
 - Operation details

3 If necessary

- ▶ **CARE AND MAINTENANCE** 18 – 21
 - Cleaning the Indoor Unit and Remote Control
 - Cleaning the Air Filter
 - Cleaning the Front Panel
 - Removing the front panel
 - Fixing the front panel
 - Cleaning the front panel
 - Replacing the Air Purifying Filters
 - Removing the air purifying filters
 - Reinstalling the air purifying filters
 - Pre-season Inspection
 - When the Air Conditioner is Not Used for an Extended Period of Time
 - Recommended Inspection
- ▶ **TROUBLESHOOTING** 22 – 23
 - Normal Operation
 - Abnormal Operation
 - Call the Dealer Immediately
- ▶ **HELPFUL INFORMATIONS** 24
- ▶ **ENERGY SAVING AND OPERATION HINTS** 25

FEATURES

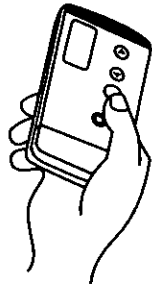
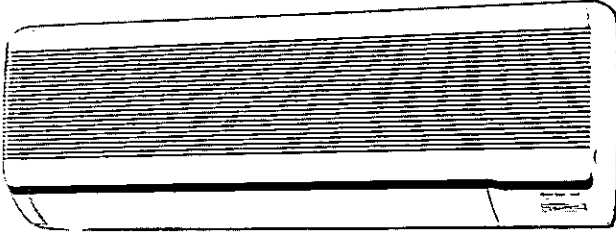

- **AUTOMATIC OPERATION**

Selects the optimum mode.

(Refer page 12)

- **SLEEP MODE**

Prevent the room from getting too hot or too cold while you are sleeping.

(Refer page 16)

- **ECONOMY MODE**

To reduce electrical power consumption.

(Refer page 17)

- **POWERFUL MODE**

Reaches the desired room temperature quickly.

(Refer page 17)

- **REMOVABLE FRONT PANEL**

For quick and easy cleaning (washable).

(Refer page 19)

- **AIR PURIFYING FILTER
(WITH DEODORIZING FUNCTION)**

Reduce dust, smoke and odours in the room.

(Refer page 20)

- **AUTO RESTART CONTROL**

Automatically restart the unit after power failure.

(Refer page 24)

Thank you for purchasing our National/
Panasonic Room Air Conditioner.

Note:
Before using your air-conditioner, please read
this operating instructions carefully and keep it
for future reference.

SAFETY PRECAUTIONS

Before operating, please read the following "Safety Precautions" carefully.

To prevent personal injury, injury to others and property damage, the following instructions must be followed.

- Incorrect operation due to failure to follow instructions will cause harm or damage, the seriousness of which is classified as follows :



Warning

This sign warns of death or serious injury.



Caution

This sign warns of damage to property.

- The instructions to be followed are classified by the following symbols :



This symbol (with a white background) denotes an action that is **PROHIBITED**.



These symbols (with a black background) denote actions that are **COMPULSORY**.

● Installation Precautions



Warning

- **Do not install, remove and reinstall the unit yourself.**
Improper installation will cause leakage, electric shock or fire. Please consult an authorized dealer or specialist for the installation work.



Caution

- **This room air conditioner must be earthed.**
- **Ensure that the drainage piping is connected properly.**



Improper grounding could cause electric shock.



Otherwise, water will leak out.

- **Do not install the unit in a place where there may be explosive gas leaks.**



Gas leaks near the unit could cause fires.

● Operation Precautions

 **Warning**
This sign warns of death or serious injury.

 Do not insert plug to operate the unit. Do not pull out plug to stop the unit.

 Plug in properly.

 Do not operate with wet hands.

 Use specified power cord.

 Do not damage or modify the power cord.



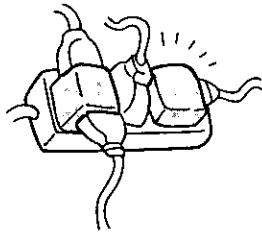

If abnormal condition (burnt smell, etc) occurs, switch off and unplug the power supply.

 Do not share outlet.

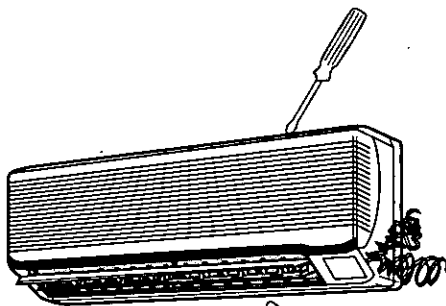

 Do not repair by yourself.



 Do not insert finger or other objects into the indoor or outdoor units.



 Do not exposed directly to cool air for a long period.

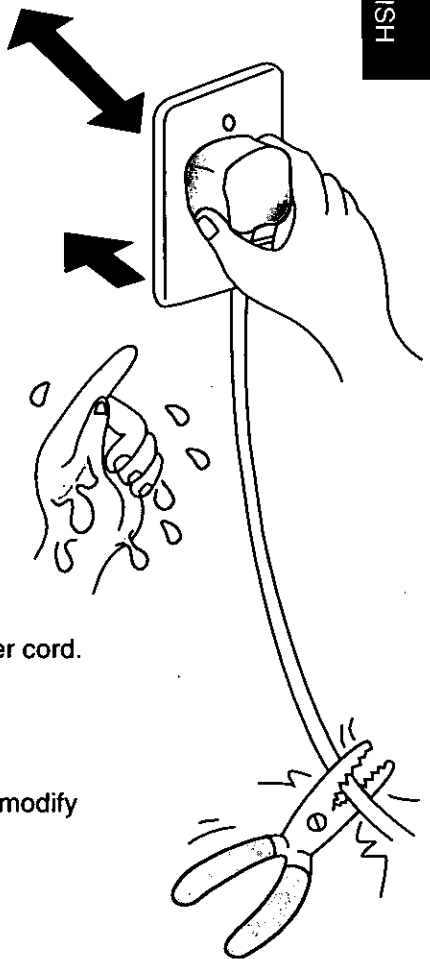
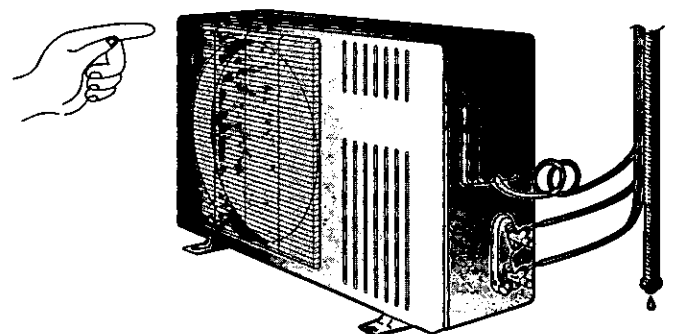



Switch off the power supply if the unit is not used for a long period.

 **Caution**
This sign warns of injury.

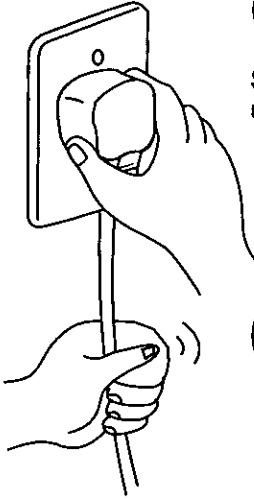

Do not pull the cord to disconnect the plug.



Switch off the unit before cleaning it.

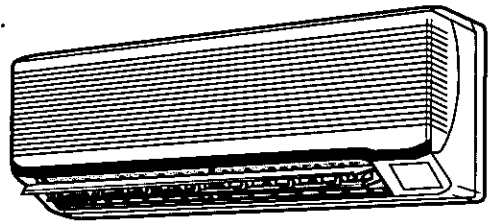

Do not wash the unit with water.



Do not use for other purpose such as preservation or etc.



Do not use any combustible equipment at airflow direction.

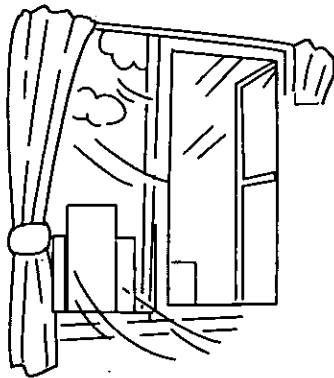
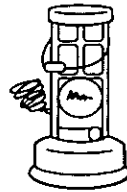

Ventilate the room regularly (once or twice every 2 hours).



Do not sit or place anything on the outdoor unit.



Pay attention as to whether the installation rack is damaged due to long period of usage.

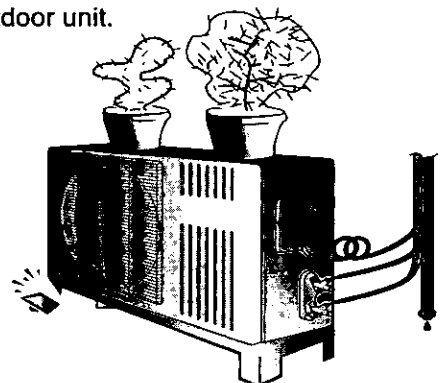

NAME OF EACH PART

● Indoor Unit

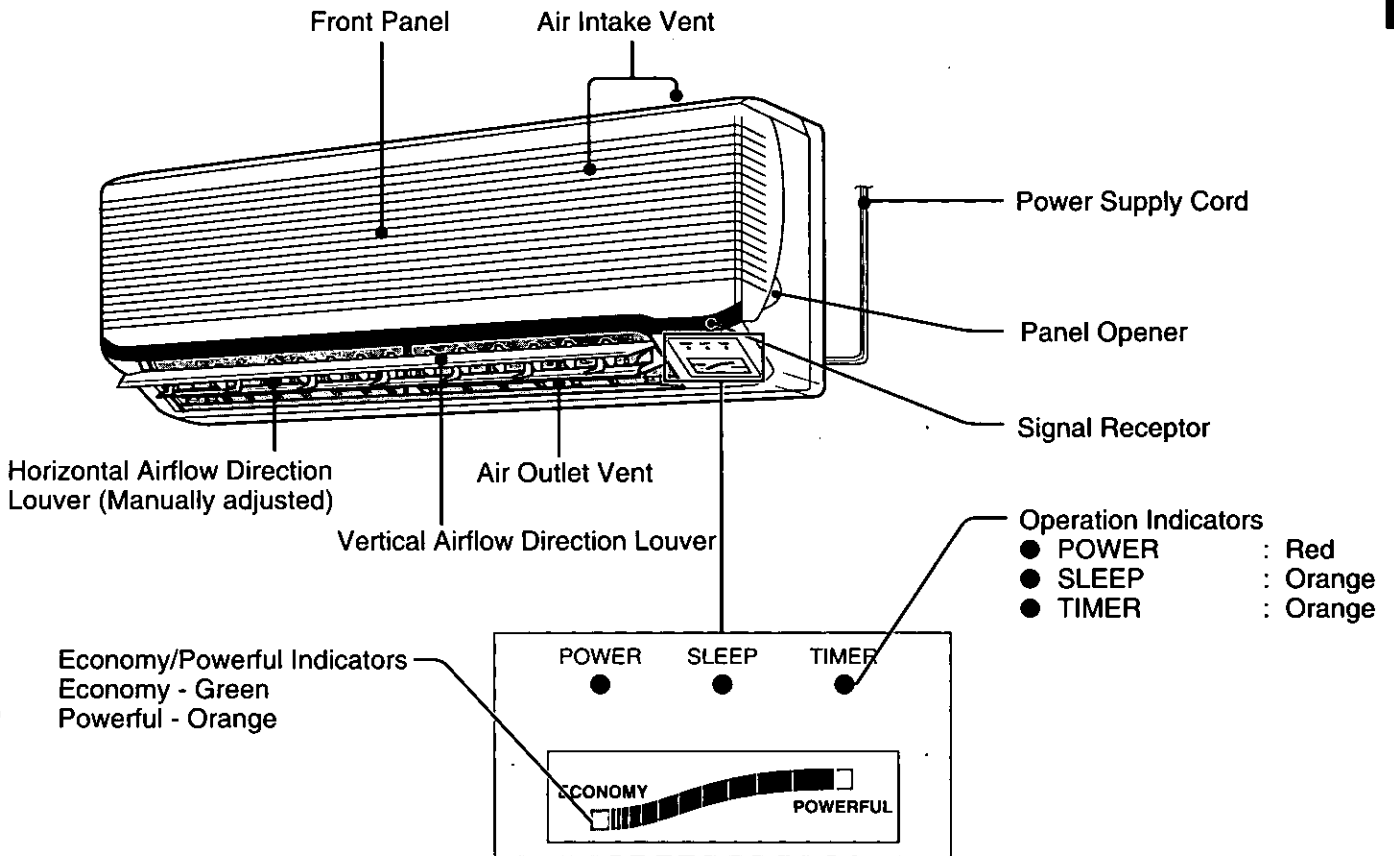

■ When the front panel is opened

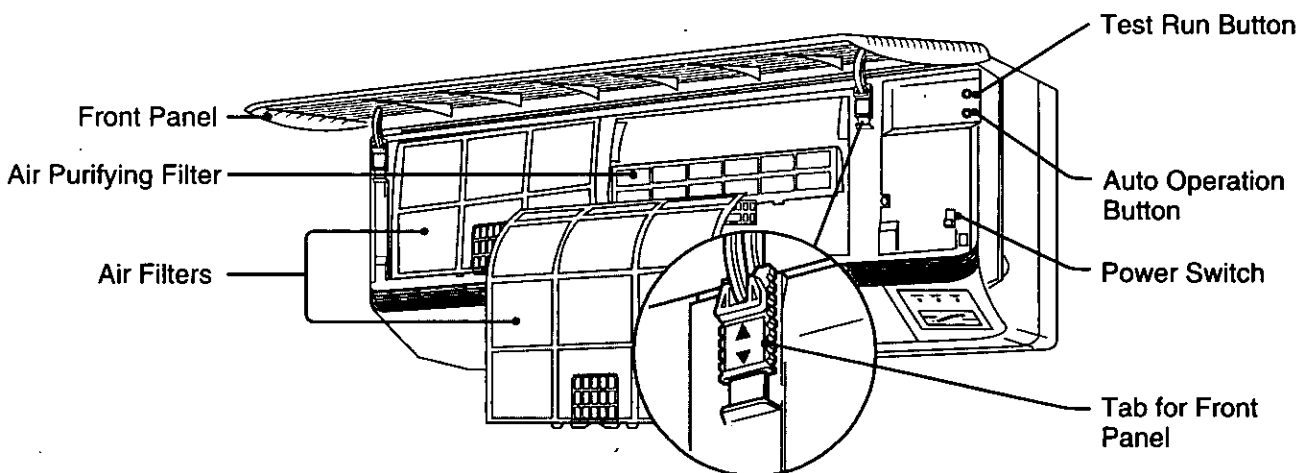

● Outdoor Unit

CU-C73K
CU-C93K

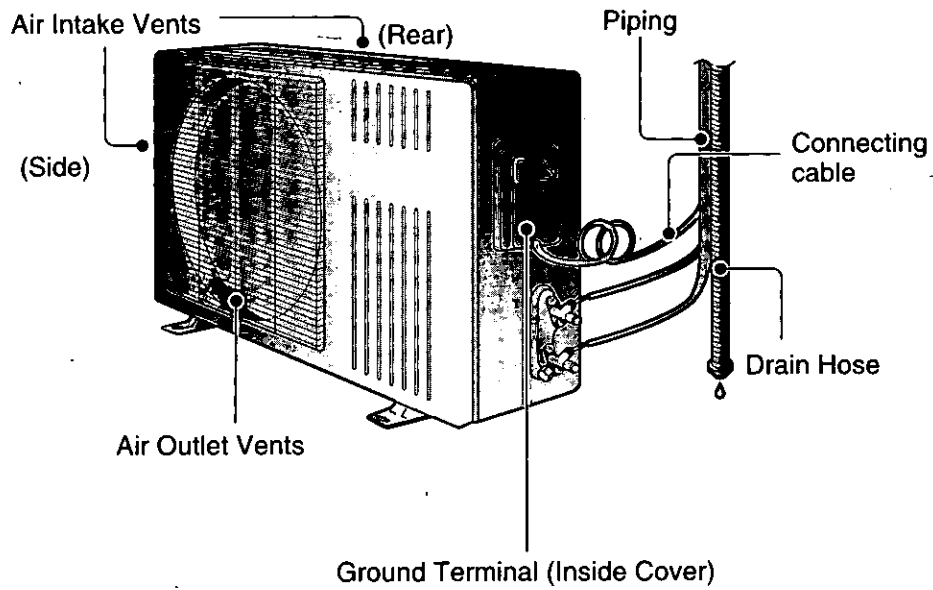

CU-C123K

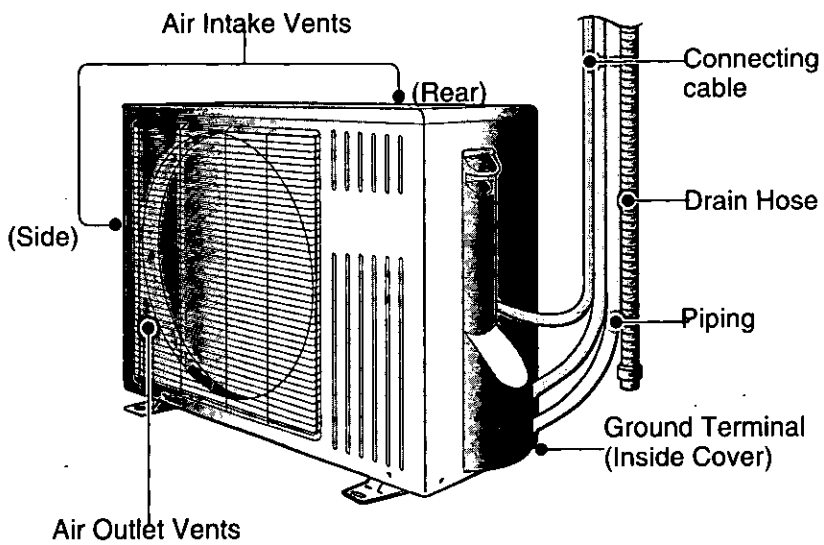

● Remote Control

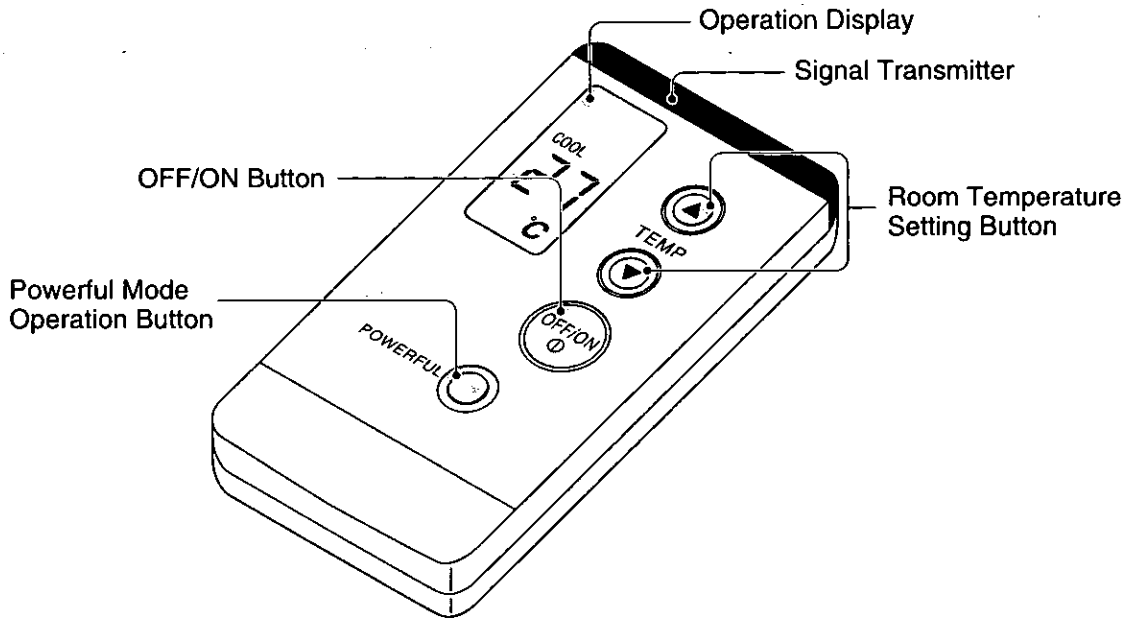

■ When the remote control cover is opened

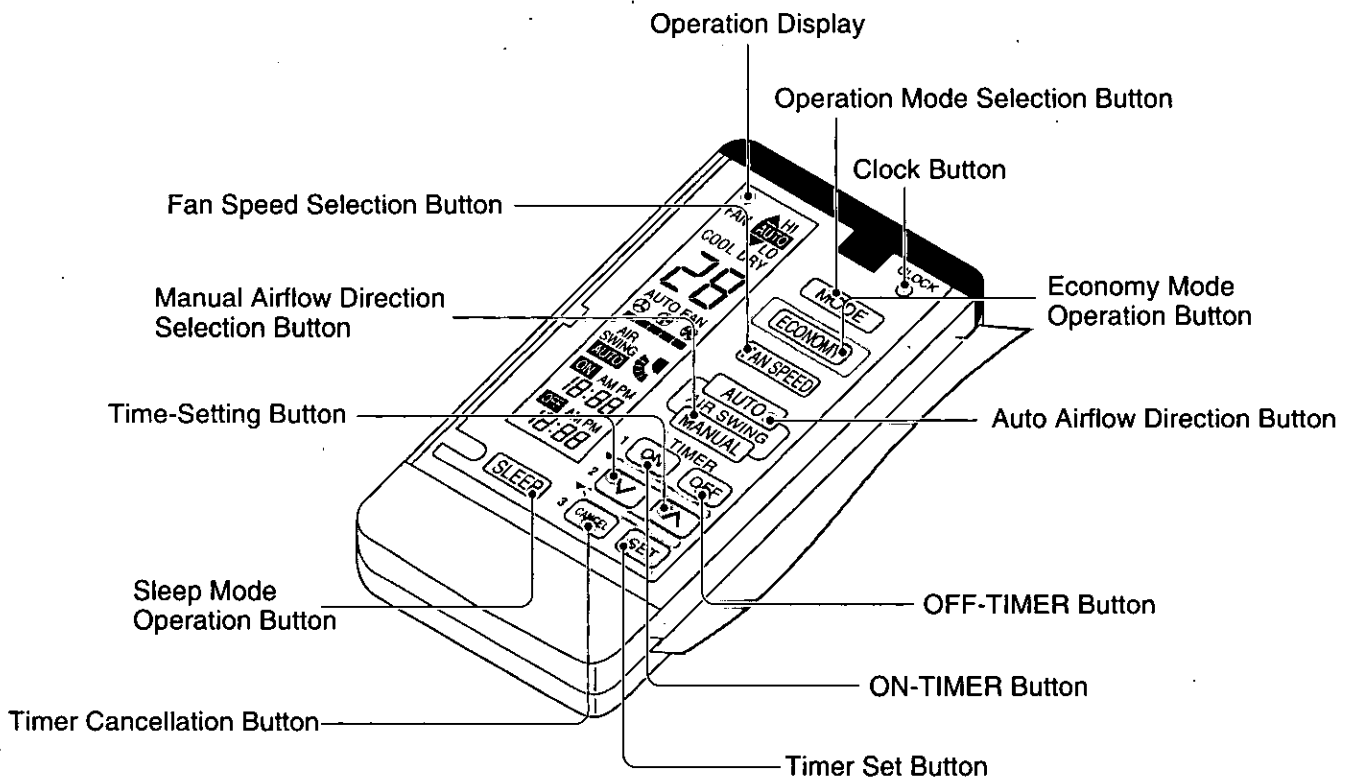

■ How to use the remote control

Notes

- Do not throw or drop
- Do not get it wet
- Certain type of fluorescent lamps may affect signal reception. Consult your dealer.

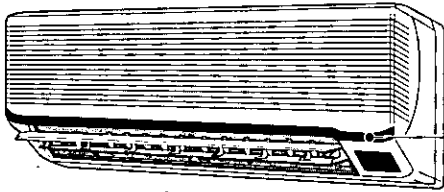

Signal receptor

- Signal received sound.
One short beep or one long beep.

- Maximum distance : 10 m
- Make sure it is not obstructed.

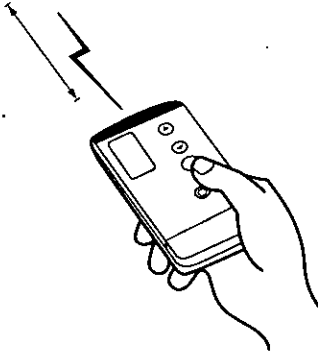

- Aim at the signal receptor.

■ When the back cover is opened

Reset points

- short to clear the memory

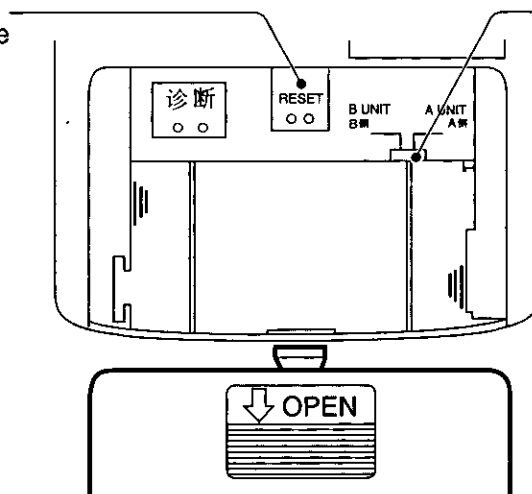

Signal [B ↔ A] switch

- Used when 2 or more units are installed in 1 room. (Consult your dealer)
- Set to A. (If one unit is installed)

PREPARATION BEFORE OPERATION

● Indoor Unit



Warning

- Ensure the power plug is securely inserted. A loose plug may cause a fire or an electric shock.

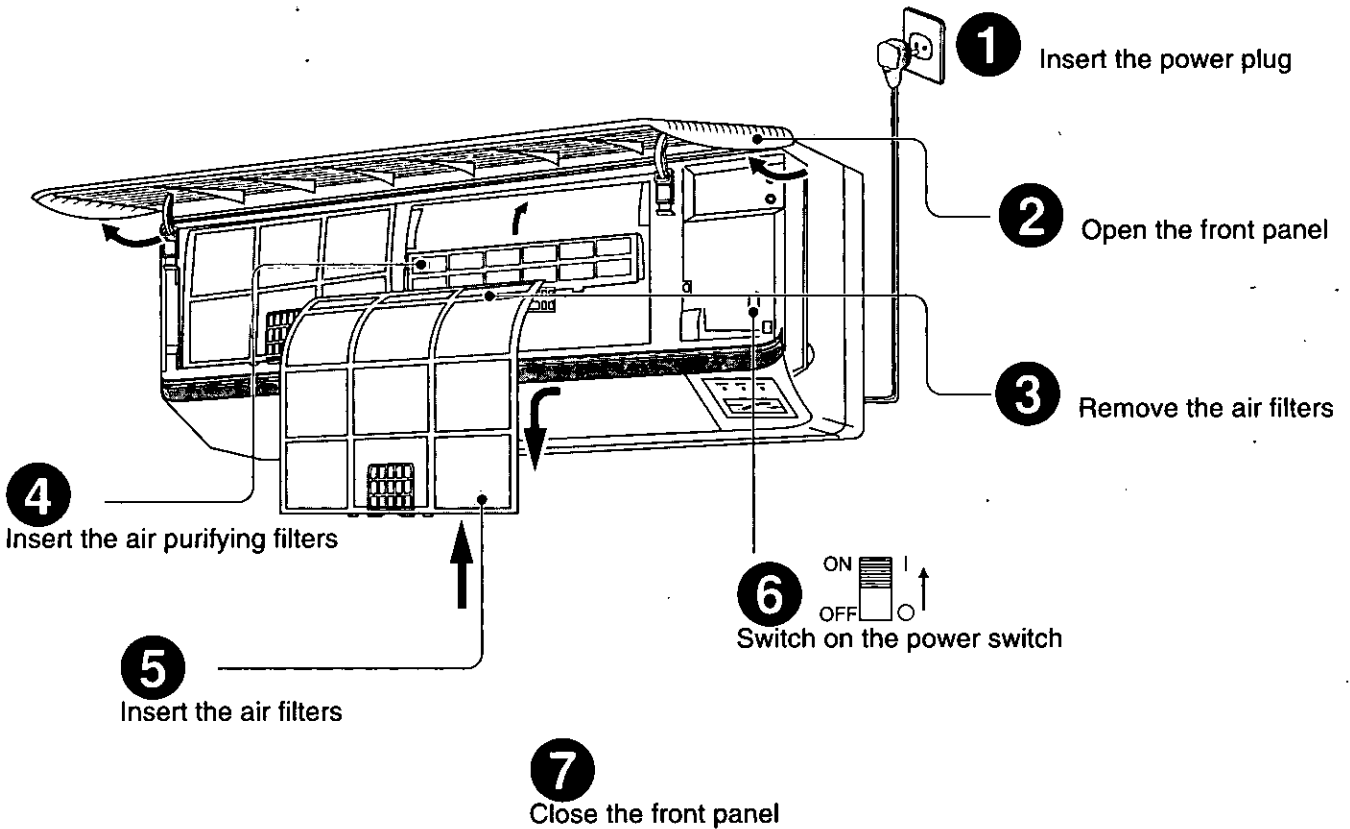

■ Notes

- If the unit is not going to be used for an extended period of time, turn off the Power switch. If it is left at the ON position, approximately 2.5 W of electricity will be used even if the indoor unit has been turned off with the remote control.
- If operation is stopped, then restart immediately, the unit will resume operation only after 3 minutes.

Use under the following conditions			(Unit in °C)	
DBT: Dry Bulb Temp	Indoor		Outdoor	
	DBT	WBT	DBT	WBT
Maximum Temperature	32	23	43	26
Minimum Temperature	16	11	16	11

● Remote Control

■ Inserting batteries

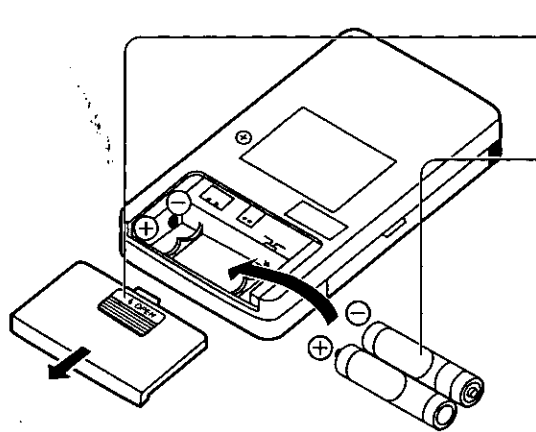

1



Slide the cover to open

2



Be sure the directions are correct

- Open the remote control cover and confirm the display 12:00 PM is flashing.

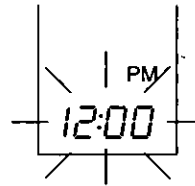

※ Set the current time (Clock) immediately to prevent battery exhaustion.

■ Setting the clock

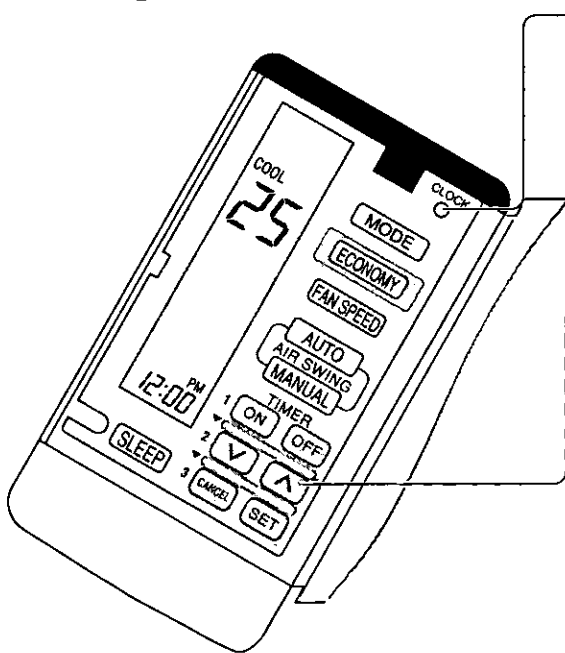

1

Press the clock button

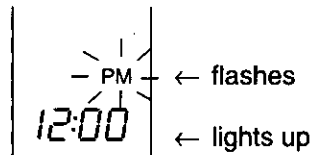

2

Press to set the current time

- Press continuously for fast forwarding.
- Press continuously for fast reversing.

3

Press the clock button

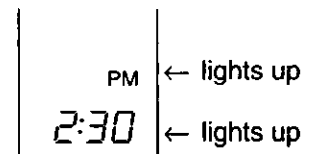

■ About the batteries

- Can be used for approximately one year.

Observe the following when replacing the batteries

- Replace with new batteries of the same type .
- Do not use rechargeable batteries (Ni-Cd).
- Remove the batteries if the unit is not going to be used for a long period.

HOW TO OPERATE

● Automatic, Cooling, Soft Dry, Fan

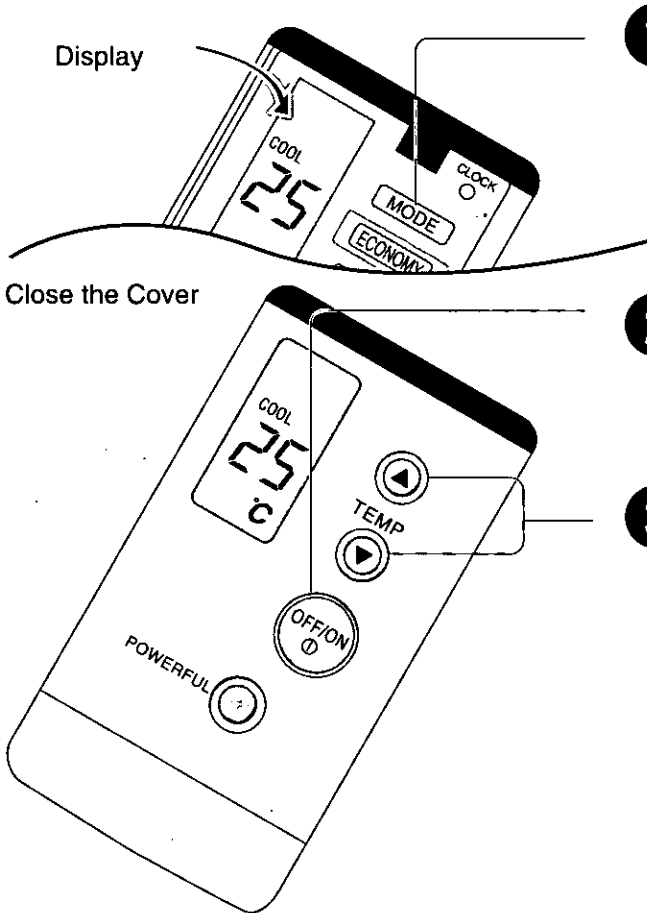

1 Press to select the desired operation mode
When pressed, the display changes in this order.



2 Press to start the operation
POWER indicator LED (Red) on indoor unit will light up.
Press once more to stop operation.

3 Press to select room temperature

- Automatic Operation Display

- Operation with 2°C higher than standard temperature.
- Operation with standard temperature.
- Operation with 2°C lower than standard temperature.

- Cooling, Soft Dry operation
- Press to increase temperature by 1°C.
- Press to decrease temperature by 1°C.
- The temperature can be set between 16°C and 30°C.
- Recommended temperature
 - For Cooling 26°C - 28°C
 - For Soft Dry 1°C - 2°C lower than room temperature.

■ Operation details

AUTO – Automatic Operation

- Once the Automatic Operation is selected, the indoor temperature sensor operates automatically to select the desired operation mode with Cooling or Soft Dry.

DRY – Soft Dry Operation

- A very gentle Cooling Operation. Consisting primarily of dehumidifying. It does not lower the room temperature.



Operation	Standard temperature
COOLING	25°C
SOFT DRY	22°C

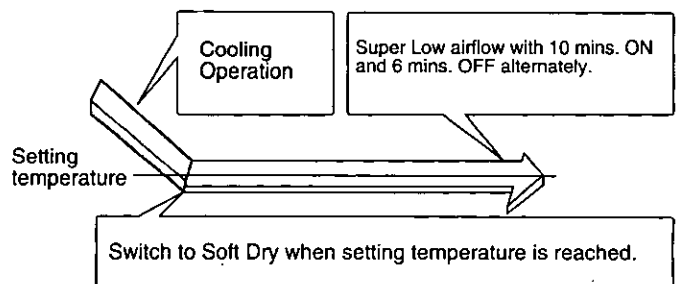

● Adjusting Airflow Direction And Fan Speed

Press to select Fan speed

- The display changes in this order

Selecting Vertical Airflow Direction
Press AUTO,

- The louver swing up and down automatically.
- To stop this operation, press **MANUAL** button.

Press MANUAL

- Manual selection of Vertical Airflow Direction Louver.
- The display changes in this order,

Horizontal Airflow Direction

- Adjust it manually.

■ Operation details

FAN – Air Circulation Operation

- When the room temperature reaches the setting temperature, operation commences at Low airflow volume. It stops when the room temperature drops to 2°C below the setting temperature. (It is useful when using a heater).

Automatic Airflow Volume

- The speed of the Indoor fan is adjusted automatically according to the operation. The Indoor fan stops occasionally during cooling operation.

Louver adjustment range

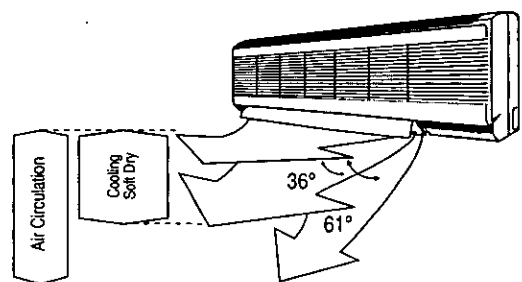

- ※ Five stages of adjustments can be made in this range.

SETTING THE TIMER

Ensure that the current time is correct before setting the timer. The timer cannot be set if the time display is flashing.

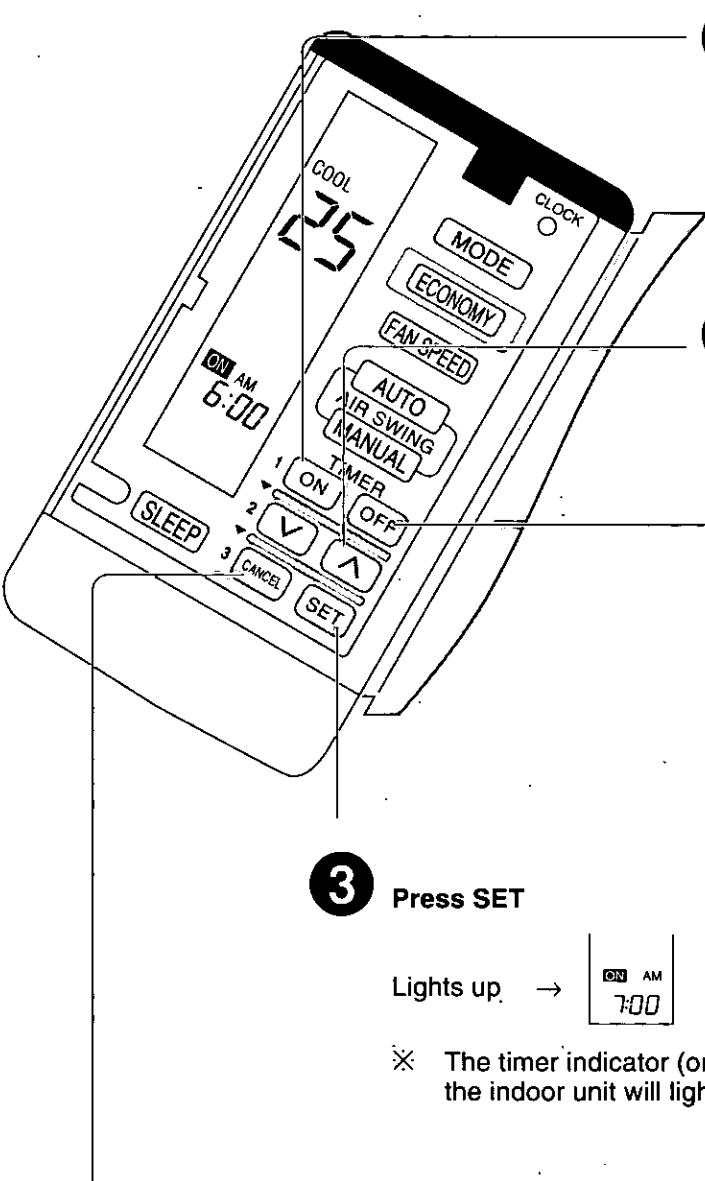

1 Press ON-TIMER

Flashes →

Example: Set the ON-TIMER to 7:00AM

2 Press to set the time

Increase by 10 minutes

Decrease by 10 minutes

※ Press continuously for quick setting.

3 Press SET

Lights up →

※ The timer indicator (orange) on the indoor unit will light up.

4 To set the OFF-TIMER
Press the OFF-TIMER then follow steps 2 and 3 as above.

■ **Timer Cancellation Button**
(To cancel the Timer)
Press the ON-TIMER or OFF-TIMER then press CANCEL.
※ The timer indicator on the indoor unit will go off.

■ To change the setting time, follow the above steps.

Timer details

- When the ON-Timer is set, operation will start before the actual set time. This is to allow the room temperature to reach the setting temperature by the setting time (maximum of 15 minutes in advance).
- Once the ON-Timer is set, operation will start at the setting time everyday.

● Recommended Setting of Timer



■ When you sleep

- Set the time at which you will go to sleep with the OFF-TIMER. This prevent wastage of electricity.

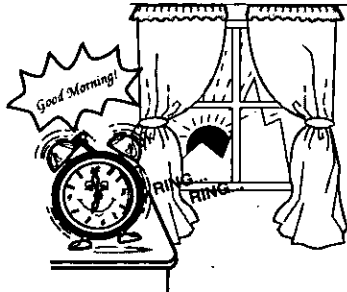

■ When you wake up

- Set the time at which you will wake up with the ON-TIMER. You can start the new day at a comfortable temperature.

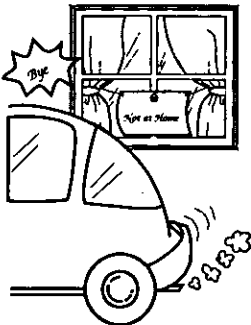

■ When going out

- Set the time at which you will go out with the OFF-TIMER. Set the time at which you will come back with the ON-TIMER.
- This will prevent the air conditioner from being left on while you are out, and the temperature will be pleasant when you return.

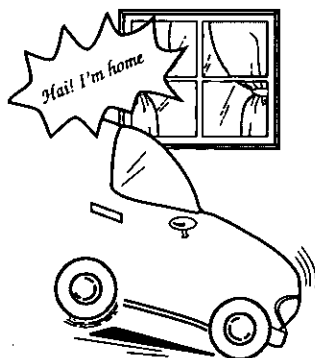

■ When you return

- Set the time at which you will return with the ON-TIMER.
- This will make the temperature pleasant when you return, and it will prevent the air conditioner from being left on.

Timer details

- The current time is not displayed when the timers are set.
- When both timers are used together, the TIMER LED on the indoor unit remains lit even if the operation is stopped by the OFF-TIMER.

CONVENIENCE OPERATION

● Sleep Mode

This is to obtain a comfortable room temperature while sleeping.

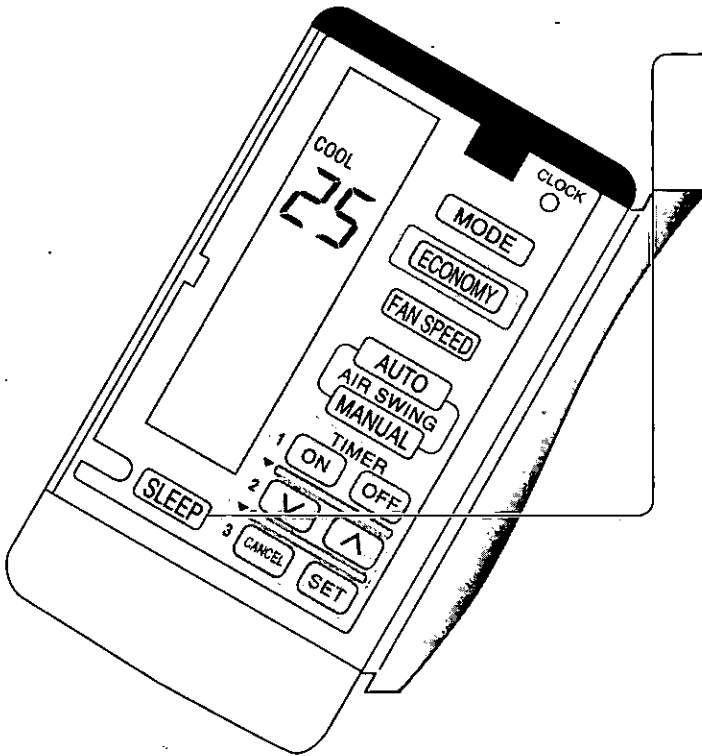

- To set the sleep mode, press **SLEEP**.
 ※ The sleep indicator on the indoor unit will light up.
- To cancel the sleep mode, press once more.

■ Operation details

- When the room temperature reaches the setting temperature, the airflow volume will automatically change to low.
- Sleep Mode Operation time is 8 hours.
- When used together with the timer, the timer has priority.
- Cooling or Soft Dry Operation for sleep mode movement will start to avoid overcooling.

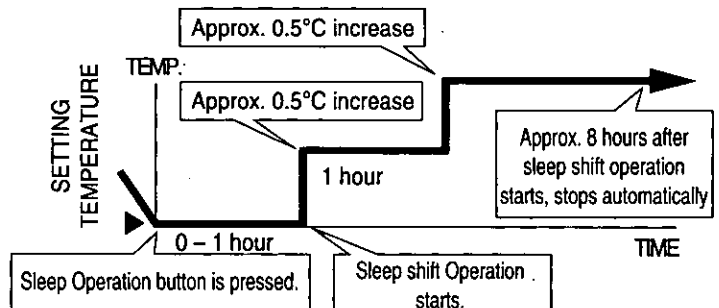

● Economy or Powerful Mode

Economy and Powerful operation cannot be selected simultaneously.

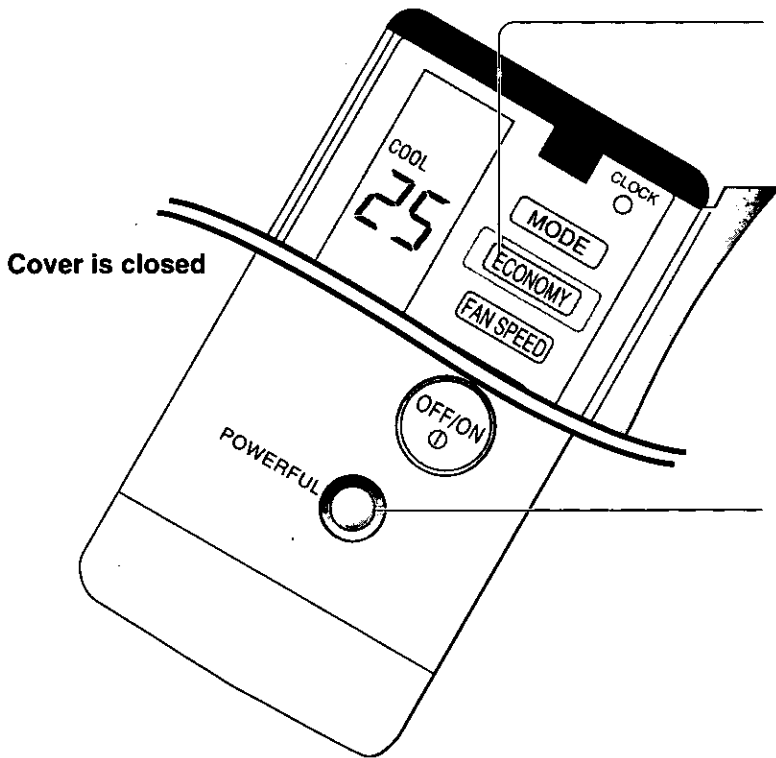

Economy Mode

To save electrical power consumption.

- Press ECONOMY
- ✘ Economy indicator (Green) on indoor unit lights up.
- Press once more to cancel this operation.

Powerful Mode

To obtain the setting temperature quickly.

- Press POWERFUL
- ✘ Powerful indicator (Orange) on indoor unit lights up.
- ✘ Powerful mode will operate for 15 minutes only.
- To cancel this operation, press once more.

■ Operation details

	Economy operation		Powerful operation	
	Temperature	Airflow volume	Temperature	Airflow volume
Cooling/Soft Dry	0.5°C higher than set temp.	Low (on and off)	3°C lower than set temp.	Super High

- ✘ • The changes of the temperature and airflow volume are automatic.
- The remote control display remain unchanged.
- If sleep button or operation mode button is pressed, economy or powerful operation is cancelled.
- During Fan-Air circulation operation, the powerful and economy operation are not available.
- During Economy mode, indoor fan operates on and off at Low speed.

CARE AND MAINTENANCE

● Cleaning the Indoor Unit and Remote Control

- Wipe gently with a soft, dry cloth.
- Do not clean with water hotter than 40°C or with polishing fluids.
- The front panel can be removed and cleaned with water.

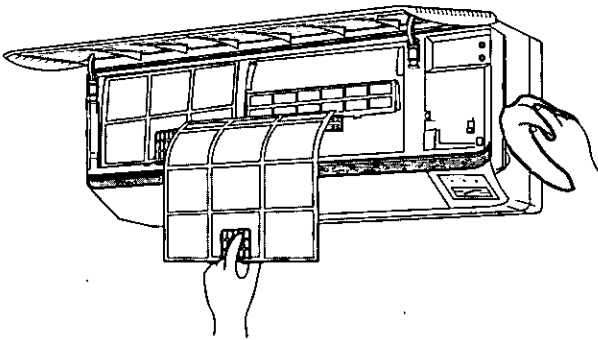

Caution

Switch OFF and unplug the power cord before cleaning the air conditioner.

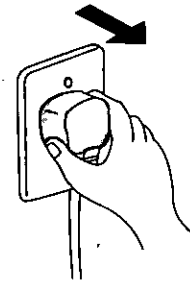

● Cleaning the Air Filter

(Recommendation:- If the unit is operated in a dusty environment, clean the filters every two weeks, continuous use of this dirty filters will reduce cooling efficiency)

- 1 Open the front grille and remove the two air filters. Hold the tab, lift up slightly then pull down.

- 2 Remove dirt using a vacuum cleaner.

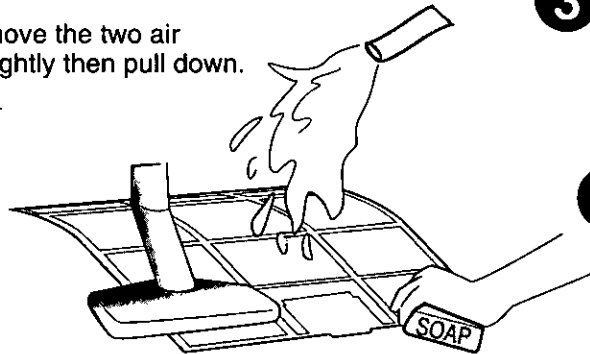

- 3 Wash back of the air filter with water.

- 4 If badly soiled, wash it with soap or a mild household detergent.

- 5 Let it dry and reinstall it. Be sure the "FRONT" mark is facing you.

※ **Damaged air filter.**
Consult the nearest authorized dealer.
Part No.: CWD00240.

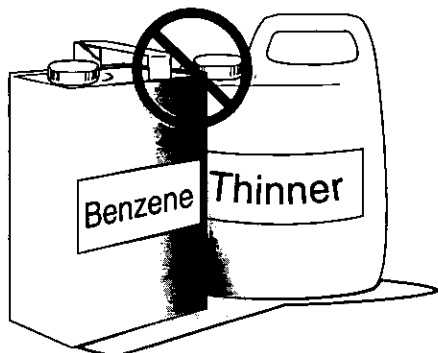

- Do not clean using benzene, thinner, scouring powder or clothes soaked in caustic chemicals.

● Cleaning the Front Panel

(Must be removed before washing)

⚠ Caution

- Stand on a level surface when removing the front panel.
- Do not touch the metal parts in the indoor unit after removing the front panel.
- Do not leave water on the panel after cleaning. Dry thoroughly to prevent electric shock.

■ Removing the front panel

- 1 Raise the front panel to its full extent.
- 2 Slide the two tabs (left and right) to the UNLOCK position.
- 3 Raise the front panel to a position slightly higher than horizontal and pull to remove.

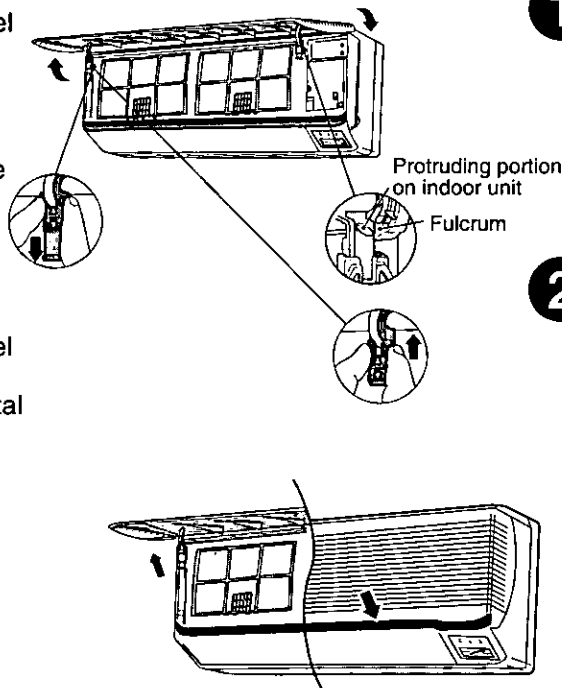

■ Fixing the front panel

- 1 Raise the front panel horizontally, match the protruding portion on the indoor unit to the fulcrum and push into place.
- 2 Slide the two tabs up to the Lock position. (Click sound)
Note: If the tabs are left in the UNLOCK position, the front panel will not close.
※ If the panel does not close completely, check the tabs positions and try again.

■ Cleaning the front panel

- Gently wash with water and a sponge. (Do not use a scrubbing brush or other hard cleaning aids).
- Do not press the front panel too hard when washing. (Excess pressure may damage the panel).
- When cleaning with kitchen cleaning fluids (neutral detergents), rinse thoroughly. (Do not use non neutral detergents)
- Do not dry the front panel in direct sunlight. (Exposure to direct sunlight may discolor or deform the panel).

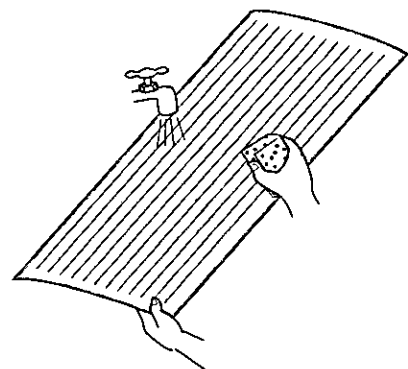

● Replacing the Air Purifying Filters

(Once every 3 month)

- Do not reuse dirty filters. Consult the nearest authorized dealer. (Air Purifying filter No. CZ-SF5N)
- These filters function effectively for not more than three months.
- If the air conditioner operates with dirty filters:-
 - Air is not purified
 - Cooling capacity decreases
 - Foul odours are emitted

■ Removing the air purifying filters

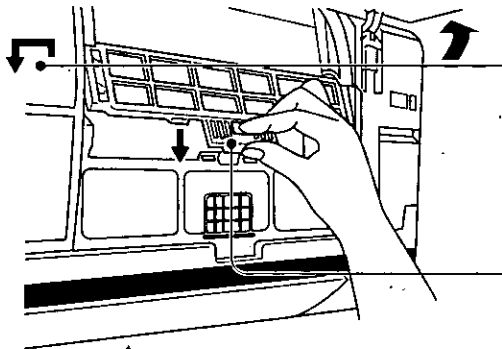

- 1** Raise the front panel to its full extent.
- 2** Remove the air filters (left and right).
 - Lift up slightly then pull down
- 3** Hold the tabs of the air purifying filters and pull.



Caution - Be careful not to hurt your hands on metal parts.

■ Reinstalling the air purifying filters

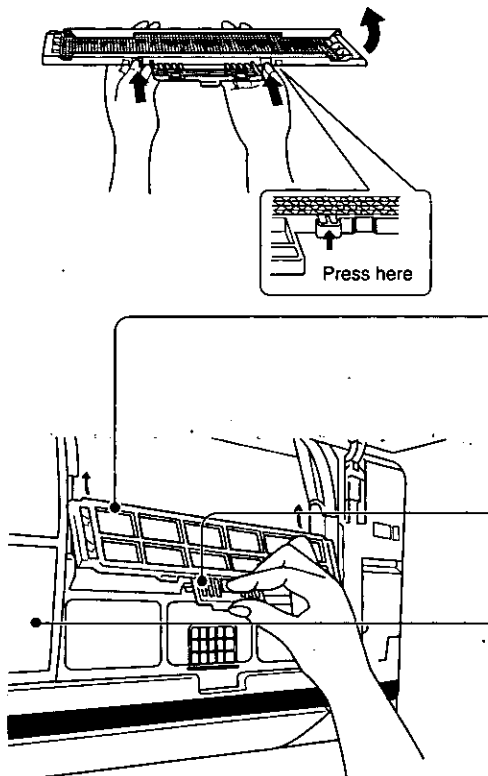

- 1** Open the filter frame to insert the new filters.
- 2** Insert the new air purifying filter.
(Be sure the "FRONT" mark is facing you)
- 3** Push until you hear a click.
- 4** Reinsert the air filters.
- 5** Close the front panel after reinstalling the air purifying filters.

● Pre-season Inspection

- **Is the discharge air cold?**

Operation is normal if 15 minutes after the start of operation, the difference between the air intake and outlet vents temperatures is 8°C or above for cooling.

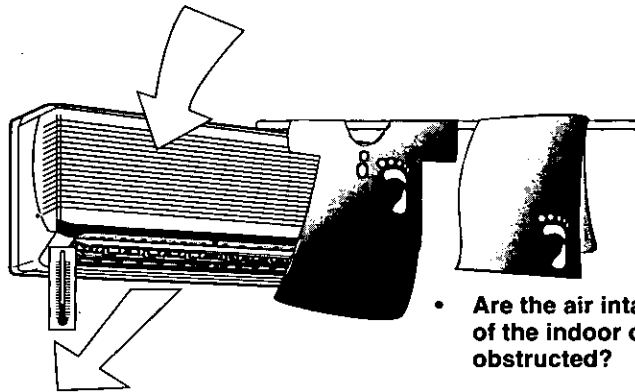

- **Are the air intake or outlet vents of the indoor or outdoor units obstructed?**

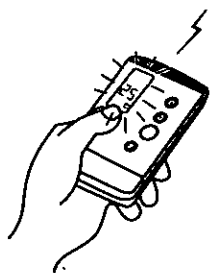

- **Are the remote control batteries weak?**

If the remote control display flashes or the display appears weak, replace the batteries (page 12).

● When the Air Conditioner is Not Used For an Extended Period of Time

- 1** To dry the internal parts of the indoor unit, operate the unit for 2 - 3 hours using Fan operation.

- 2** Turn off the power switch and remove the power supply plug.
Note: If the unit is not switched off by the remote control, it will start operating when you plug in (because a Auto Restart Control is provided).

- 3** Remove the remote control batteries.

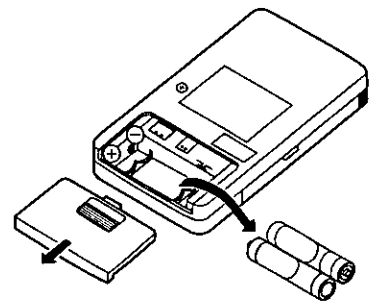
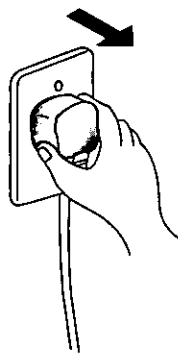

● Recommended Inspection

- The unit will become dirty after use over several seasons, reducing performance. Depending on the operation condition, a dirty unit may produce foul odours and dust may pollute the dehumidifying drainage. Seasonal inspection is recommended, in addition to regular cleaning. Consult an authorized dealer.

TROUBLESHOOTING

● Normal Operation

Q - Is it okay? **A** - This is the answer.

Q - Air conditioner has been restarted, but does not operate for 3 minutes.
A - This is to protect the air conditioner. Wait until the air conditioner begins operating.

Q - A sound like water flowing can be heard.
A - This is the sound of refrigerant flowing inside the air conditioner unit.

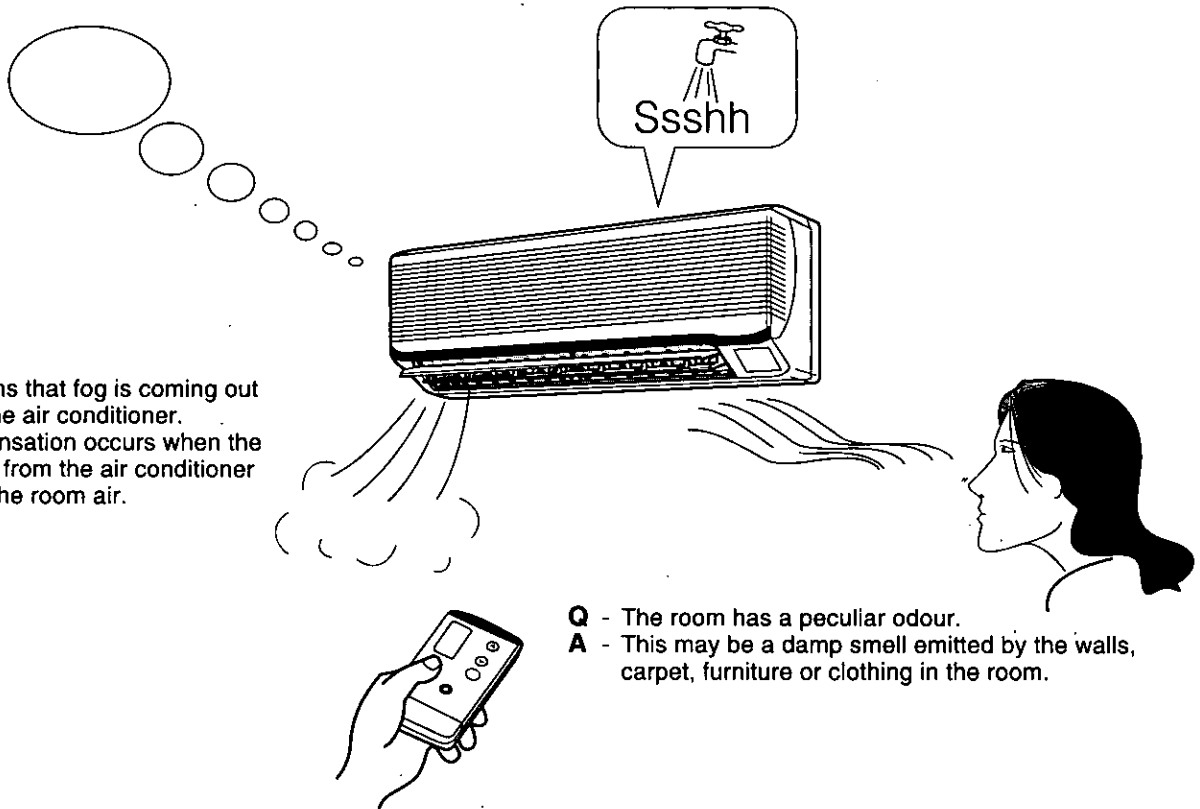

Q - It seems that fog is coming out from the air conditioner.
A - Condensation occurs when the airflow from the air conditioner cools the room air.

Q - The room has a peculiar odour.
A - This may be a damp smell emitted by the walls, carpet, furniture or clothing in the room.

DRY

Q - During soft dry mode operation the air conditioner stops.
A - Soft Dry Mode operation is a very gentle cooling operation consisting primarily of dehumidifying. The air conditioner may stop for approximately 6 minutes in order to prevent overcooling. If the room temperature rises again, the operation will recommence.

AUTO FAN

Q - During Automatic Airflow Volume setting, Indoor fan stops occasionally.
A - This is to remove the smell emitted by the surroundings.

● Abnormal Operation

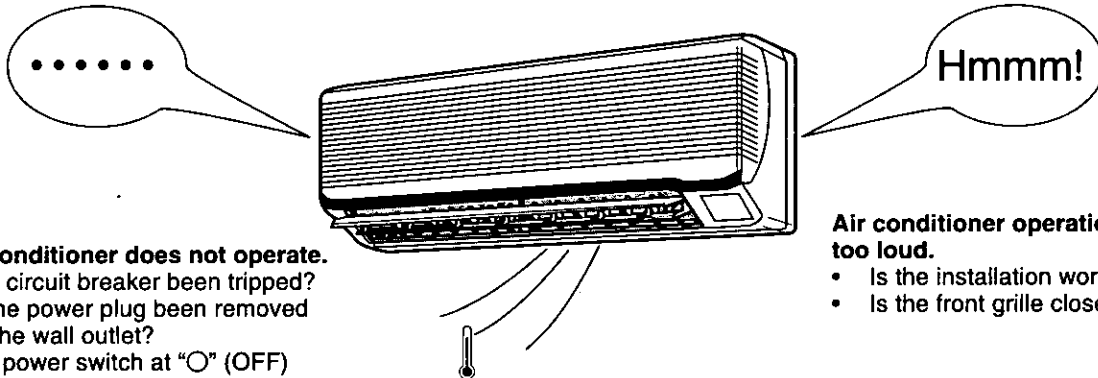

The air conditioner does not operate.

- Has a circuit breaker been tripped?
- Has the power plug been removed from the wall outlet?
- Is the power switch at "O" (OFF) position?
- Is the timer being used correctly?
- Has the remote control B↔A switch been set correctly?

Air conditioner operation noise too loud.

- Is the installation work slanted?
- Is the front grille closed properly?

The air conditioner does not cool effectively.

- Has the temperature been set incorrectly?
- Are the filters dirty?
- Are the intake or outlet vents of the outdoor unit obstructed?
- Are all windows and doors closed?

● Call the Dealer Immediately

If the following conditions occur, immediately turn the power switch to "O" (OFF) and unplug.

- Abnormal noise is heard during operation.

- Switches or buttons do not operate properly.

- Water or foreign material gets into the remote control by mistake.

- The circuit breaker switches off frequently.

- Water leaks from the indoor unit.

- Power supply cord and plug become unusually warm.

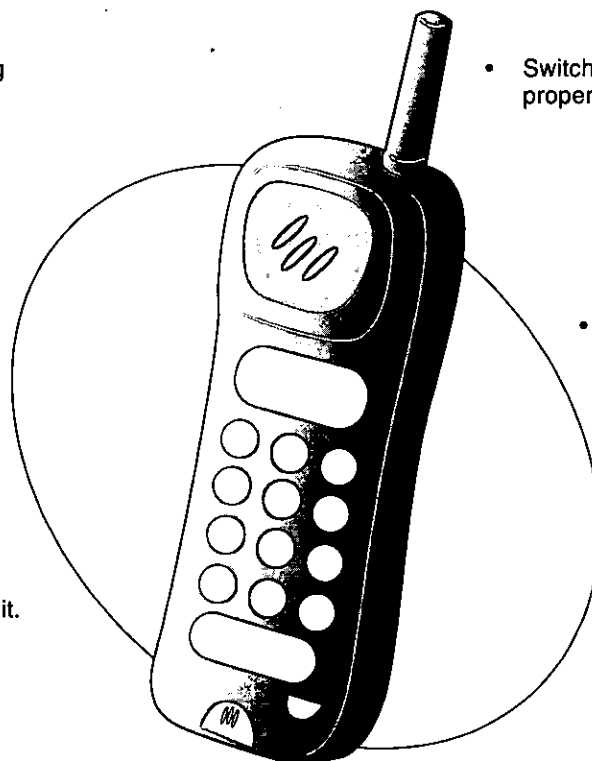

HELPFUL INFORMATION

Auto Operation and Test Run Button

Auto Operation Button

(If remote control fails to function or misplaced)

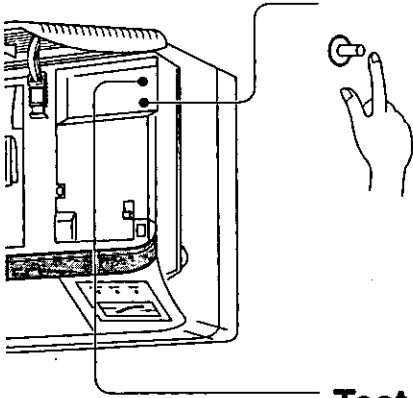

- 1** Press the Auto Operation Button for automatic operation. But the temperature cannot be adjusted.
※ The power LED on indoor unit blinks until the operation mode is selected automatically.

- 2** To cancel, press once more.

Test Run Button

Ⓒ For installation or servicing purpose only.



- To switch off the beep (signal received) sound, press the Auto Operation Button at the indoor unit for 10 seconds or longer. Repeat the above if you want to switch on the beep sound.

Auto Restart Control

- If power is resumed after a power failure, the operation will restart automatically after 3 - 5½ minutes.
- Operation will be automatically restart under the previous operation mode and airflow direction when power is resumed as the operation is not stopped by remote control.

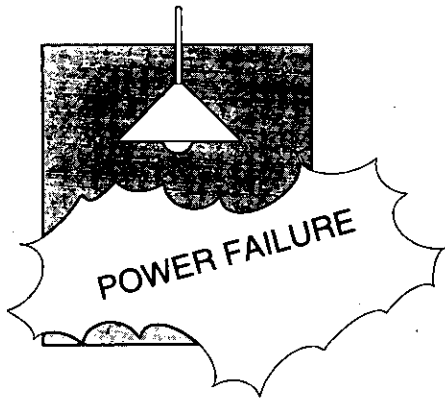

Timer Setting

- When power failure occurs, the timer setting is cancelled. Once power is resumed, reset the timer.

Thunder and Lighting

- Whenever there is lighting, stop operation to protect the air conditioner. Turn the power switch to OFF, then unplugged the power supply plug.

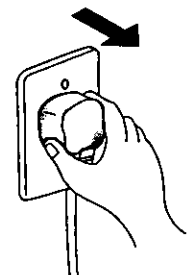
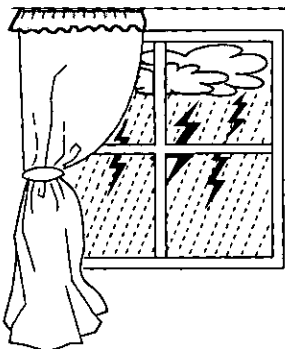



Warning

- 1) This appliance must be earthed.
- 2) If the supply cord is damaged or need to be replaced, it must be replaced by the manufacturer or its service agent or a similarly qualified person in order to avoid a hazard.
- 3) Remove power plug or disconnect from the mains before servicing this appliance.
- 4) Do not repair by yourself.
In case of malfunction of this appliance, do not repair by yourself.
Contact to the sales dealer or service dealer for a repair.
- 5) Do not use in an explosive atmosphere.

Do not use this appliance in a potentially explosive atmosphere.
- 6) Turn off the power (Isolation from main power supply).
Pull off the power plug from the receptacle, or switch off the breaker, or switch off the power disconnecting mean to isolate the equipment from the main power supply in case of an emergency.



Caution

DISCONNECT THE MAINS PLUG FROM THE SUPPLY SOCKET WHEN NOT IN USE, WHERE SUPPLY CONNECTION IS VIA MAINS PLUG.

Airborne noise.

A-weighted sound pressure level of this appliance is less than 70dB (A) under the JIS C 9612 test conditions.

Maximum cooling operation
1 m from the unit

IMPORTANT

The wires in this mains lead are coloured in accordance with the following code:

Green and Yellow	:	Earth
Blue	:	Neutral
Brown	:	Live

"As the colours of the wires in the mains lead of this appliance may not correspond with the coloured markings identifying the terminals in your plug, proceed as follows:

The wire which is coloured green and yellow must be connected to the terminal in the plug which is marked by the letter E or by safety earth symbol Ⓧ or coloured green or green and yellow.

The wire which is coloured blue must be connected to the terminal which is marked with letter N or coloured black.

The wire which is coloured brown must be connected to the terminal which is marked with letter L or coloured red."

Matsushita Air conditioning Group
P.O. Box 1012, Jalan Semangat 46966,
Petaling Jaya, Selangor Darul Ehsan, Malaysia

Printed in Malaysia

MACC P990105000CT