

This Owner's Manual is provided and hosted by Appliance Factory Parts.

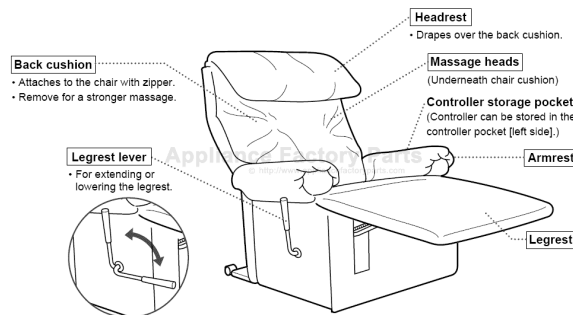

PANASONIC EP1015 Owner's Manual

**Shop genuine replacement parts for PANASONIC
EP1015**



Find Your PANASONIC Massage Lounger Parts - Select From 25 Models

----- Manual continues below -----

Panasonic®

Operating Instructions Manuel d'utilisation Instrucciones de funcionamiento

Household Massage Lounger
Fauteuil vibromasseur
Silla de masaje para el hogar

Model No. **EP1015**

Modèle No. **EP1015**

Modelo No. **EP1015**

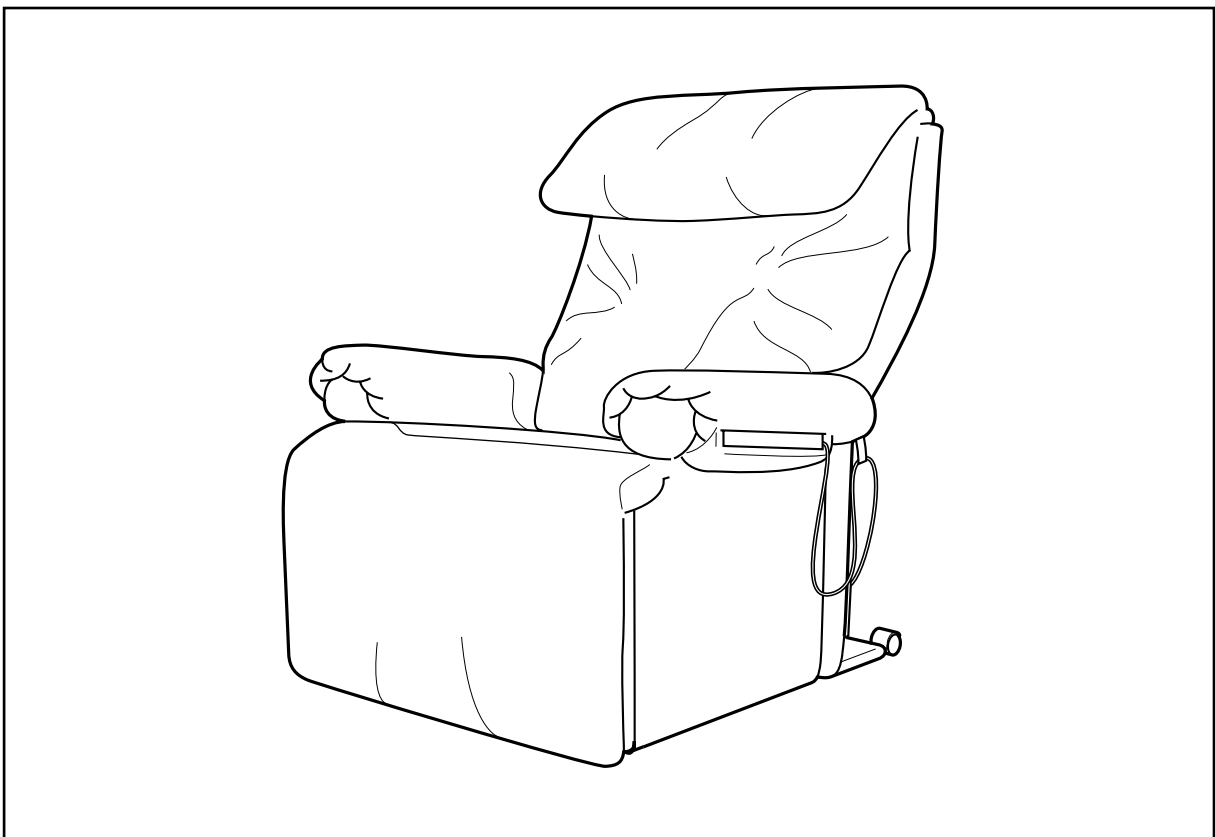

Before operating this unit, please read these instructions completely and save this manual for future use.

Avant d'utiliser cet appareil, veuillez lire complètement ces instructions et conserver ce manuel à titre de référence.

Antes de utilizar esta unidad, lea completamente estas instrucciones y guarde este manual para utilizarlo en el futuro en caso de ser necesario.

TABLE OF CONTENTS

IMPORTANT SAFETY INSTRUCTIONS	3	HOW TO USE	10
SAFETY PRECAUTIONS	4	• TO START/STOP MASSAGE ACTION	10
OPERATING PRECAUTIONS	5	• LEG MASSAGER OPERATION	10
GROUNDING INSTRUCTIONS	6	• PROGRAMMED MASSAGE	11
HOW TO MOVE THE CHAIR	6	• MANUAL MASSAGE	12
PARTS IDENTIFICATION	7	• BACK CUSHION AND HEADREST	15
BEFORE USE	8	• CUSHION INSERT PAD	15
• PLACE OF USE	8	• DETAILS OF PROGRAMMED MASSAGE	16
• TURNING ON THE POWER	8	• MASSAGE HEADS' RANGE OF MOVEMENT	17
• BEFORE SITTING DOWN	8	TROUBLESHOOTING GUIDE	18
• RECLINING THE CHAIR	9	SPECIFICATIONS	19
• HOW TO EXTEND THE LEGREST MANUALLY	9		

TABLE DES MATIÈRES

REMARQUES IMPORTANTES CONCERNANT LA SECURITE	20	UTILISATION	27
CONSIGNES DE SÉCURITÉ	21	• POUR LANCER/ARRÊTER LE MASSAGE	27
PRÉCAUTIONS À SUIVRE	22	• MASSAGE DES JAMBES	27
INSTRUCTIONS POUR LA MISE À LA TERRE	23	• MASSAGE PROGRAMMÉ	28
DÉPLACEMENT DU FAUTEUIL	23	• MASSAGE MANUEL	29
IDENTIFICATION DES ELEMENTS	24	• COUSSIN DU DOSSIER ET APPUIE-TÊTE	32
AVANT L'UTILISATION	25	• GARNITURE D'INSERTION DU COUSSIN	32
• EMBLACEMENT	25	• DETAILS D'UN MASSAGE PROGRAMME	33
• MISE SOUS TENSION	25	• PLAGE D'ÉVOLUTION DES TÊTES DE MASSAGE	34
• AVANT DE S'ASSEOIR	25	GUIDE DE DÉPANNAGE	35
• INCLINAISON DU FAUTEUIL	26	CARACTÉRISTIQUES TECHNIQUES	36
• EXTENSION DE L'APPUIE-JAMBES MANUELLEMENT	26		

ÍNDICE

INSTRUCCIONES DE SEGURIDAD IMPORTANTES	37	UTILIZACIÓN	44
PRECAUCIONES DE SEGURIDAD	38	• PARA INICIAR/DETENER LA ACCIÓN DE MASAJE	44
PRECAUCIONES PARA LA OPERACIÓN	39	• OPERACIÓN DEL MASAJEADOR DE LAS PIERNAS	44
INSTRUCCIONES PARA LA CONEXIÓN A TIERRA	40	• MASAJE PROGRAMADO	45
CÓMO MOVER LA SILLA	40	• MASAJE MANUAL	46
IDENTIFICACIÓN DE PARTES	41	• COJÍN DEL RESPALDO Y APOYO PARA LA CABEZA	49
ANTES DE UTILIZAR LA SILLA DE MASAJE	42	• COJÍN DE ESPUMA	49
• LUGAR DE UTILIZACIÓN	42	• DETALLES DEL MASAJE PROGRAMADO	50
• CONEXIÓN DE LA ALIMENTACIÓN	42	• ALCANCE DE MOVIMIENTO DE LAS CABEZAS DE MASAJE	51
• ANTES DE SENTARSE	42	GUÍA PARA LA LOCALIZACIÓN Y SOLUCIÓN DE PROBLEMAS	52
• RECLINACIÓN DE LA SILLA	43	ESPECIFICACIONES	53
• CÓMO EXTENDER MANUALMENTE EL APOYO PARA LAS PIERNAS	43		

– Customer's Record –

Please record both the model and serial numbers of this product in the spaces provided. Retain this book, along with a copy of your purchase receipt, for future reference. The serial number can be found just above the power switch at the rear of the chair.

Model Number

Numéro de modèle

Número de modelo _____

Serial Number

Numéro de série

Número de serie _____

Dealer's Name

Nom du revendeur

Nombre del concesionario _____

Date Purchased

Date de l'achat

Fecha de adquisición _____

– Mémo pour le client –

Veillez noter les numéros de modèle et de série de cet équipement dans les espaces réservés à cet effet. Conservez la présente notice avec une copie de votre reçu d'achat en cas de références ultérieures.

– Anotación del cliente –

Anote los números de modelo y serie de este producto en los espacios suministrados. Guarde este manual junto con una copia de su recibo de compra para utilizarlos como referencia en el futuro.

Thank you for purchasing the Panasonic Household Massage Lounger EP1015.
For optimum performance and safety, please read these instructions carefully.

IMPORTANT SAFETY INSTRUCTIONS

When using an electrical appliance, basic precautions should always be followed, including the following:

Read all instructions before using the massage lounger.

DANGER – To reduce the risk of electric shock:

Always unplug this appliance from the electrical outlet immediately after using and before cleaning.

WARNING – To reduce the risk of burns, fire, electric shock or injury to persons:

1. An appliance should never be left unattended when plugged in. Unplug from outlet when not in use.
2. Close and continuous supervision is necessary when this appliance is used by invalids or disabled persons.
3. Use this appliance only for its intended use as described in this manual.
4. Do not stand on or in the appliance. Use only while seated.
5. Do not use accessories not recommended by the manufacturer.
6. This appliance should not be used by children. Keep children away from massage lounger. To avoid possible injury always return chair to an upright position and retract the legrest carefully. Make sure nothing can be caught in the legrest mechanism.
7. Never operate this appliance if it has a damaged cord or plug, if it is not working properly or if it has been damaged. Call your nearest authorized service center for repair.
8. Keep the cords away from heated surfaces.
9. Never drop or insert any object into any opening.
10. Do not use outdoors.
11. Do not operate where aerosol spray products are being used or where oxygen is being administered.
12. To disconnect, turn all controls to the “off” position, then remove plug from outlet.
13. Connect this appliance to a properly grounded outlet only.
See Grounding Instructions.
14. To avoid the risk of electric shock or personal injury, do not attempt to open or disassemble any part of this massage lounger. Never insert hands in areas where there are moving parts. There are no user-serviceable parts.

SAVE THESE INSTRUCTIONS

SAFETY PRECAUTIONS

WARNING: To avoid risk of injury

1. This product should not be used by pregnant women, persons who are ill, or persons with back, neck, shoulder or hip pain, or conditions of any kind, without consulting a physician prior to use. Do not use on any area of the body that has received medical treatment without consulting a physician prior to use.
2. Never put any part of the body between the massage heads. The squeezing action of the massage heads may cause injury. Never put any part of the body between the armrest and the chair back.
Do not place hands in the mechanical portion of the legrest located under the seat.
3. Do not use against bare skin; always wear clothing.
Thin clothing increases the effectiveness, but exposing the skin directly to the massager can irritate the skin.
4. Do not use for massaging the head, abdomen, elbows or knees.
5. Do not stretch the back muscles for more than approximately 15 minutes at one time.
To avoid overstretching of muscles and resulting discomfort when first using the chair, do not use for more than 5 minutes. You can gradually increase duration and intensity as you adjust to the chair.
Do not massage any one point for longer than 5 minutes at a time.
Excessive massaging can overstimulate the muscles and nerves and result in an adverse effect.
To prevent excessive massaging, do not use the massager for more than a total of 15 minutes per session. After approximately 15 minutes, the massage heads will return to the "resting" position and stop.
6. While using the massager, if you start feeling sick, or if the massage seems painful, stop use immediately.
While using the massager, if the pressure seems too strong, the movement of the massage heads can be stopped by pressing the "quick stop" button.
7. When the chair back is in a reclined position, do not sit on it, or sit with your legs resting on the headrest.
Do not sit on the legrest. The chair may fall over.
8. Do not allow children or pets to play on or around the chair, especially during operation.
9. Do not remove the back cushion without first reading instructions on page 15.

OPERATING PRECAUTIONS

WARNING: To avoid damage to the chair

1. The chair is designed for a maximum user weight of 264 lbs. (120 kg). Exceeding the maximum weight may cause permanent damage to the massage mechanism and/or other components of the chair. Any such damage is deemed to be user abuse and is not covered under the Limited Warranty.
2. Do not sit on or drop the controller. Do not pull the controller cord or the power cord. Be careful not to catch the cord of the controller between the armrest and the chair back.
3. Do not treat the chair roughly, such as forcing the reclining lever, turning the chair on its side, turning the chair over or standing on it.
4. Do not treat the covering roughly.
 - Keep sharp or pointed objects away from the covering of the chair. Be careful not to drop lit ashes or matches on the chair.
 - Exposure to direct sunlight can cause fading or a change in color of the covering.
5. If the massager functions abnormally, immediately turn off the power and have the massager checked by an authorized service center.
6. Do not attempt to repair the massager yourself.
7. Do not repeatedly operate any switch at short intervals. Such action may cause the switch to malfunction.
8. Some noise may be heard coming from the massager while in use. This is due to the structure of the massager and is normal.
9. Make sure there are no obstacles behind the chair before reclining it. The chair can be reclined to a maximum angle of 160°. If the back hits a wall or pillar, the chair may malfunction. Be sure to have ample space behind the chair. Recline the chair slowly in order to avoid contact with an obstacle.
10. When excessive pressure is applied to the massage heads, they may stop moving for safety. When moving the heads up from the lowered position, one's body weight may stop the heads' movement. In such case, slightly raise the body and allow the massage heads to move up.
11. After each massage, slide the power switch, which is located on the back of the chair, to the "off" position and turn its lock switch to the "lock" position.

CARING FOR THE MASSAGER

- Always unplug the chair before cleaning.
- If the covering becomes soiled, dampen with liquid soap and brush the surface. Wipe with a cloth dampened with water. Allow to dry naturally. If the plastic portions become soiled use lukewarm water, with liquid soap on a soft cloth, to clean the surface.
- Do not use thinner, benzene or other solvent-type cleaners. Chemicals can discolor or damage the materials.

GROUNDING INSTRUCTIONS

- This product must be grounded. If it should malfunction, grounding provides the path of least resistance for electric current to reduce the risk of electric shock.
- This product is equipped with a cord having an equipment-grounding conductor and a grounding plug. The plug must be plugged into an appropriate outlet that is properly installed and grounded in accordance with all local codes and ordinances.

DANGER

- Improper connection of the equipment-grounding conductor can result in a risk of electric shock. Check with a qualified electrician if you are in doubt as to whether the product is properly grounded. Do not modify the plug provided with the product even if it does not fit the outlet. Have a proper outlet installed by a qualified electrician.
- This product is for use on a nominal 120-volt circuit and has a grounding plug that looks like the plug shown in Figure A. Make sure that the product is connected to an outlet having the same configuration as the plug. No adaptor should be used with this product.

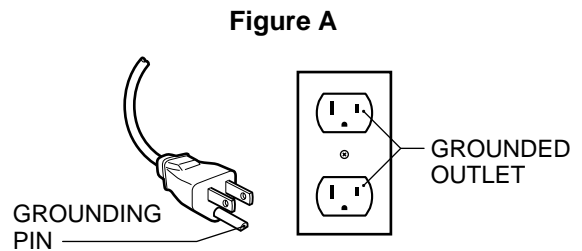

HOW TO MOVE THE CHAIR

CAUTION

Do not move the chair while someone is sitting in it.

Failure to observe this point may cause the chair to tip over, possibly resulting in personal injury.

Use the casters to move the chair.

- Do not attempt to move the chair by lifting from the front (right illustration). The correct way to move the chair is by putting your foot on the caster and pushing down from behind the chair (left illustration).
- It is easier to move the chair if the massage heads have been moved to their resting positions and the backrest reclined.
- Moving the chair may damage easily marked floor surfaces; therefore, place a mat or cloth on the floor and move the chair slowly.
- Before pushing down the chair, prepare yourself for its weight and exercise caution when moving it.

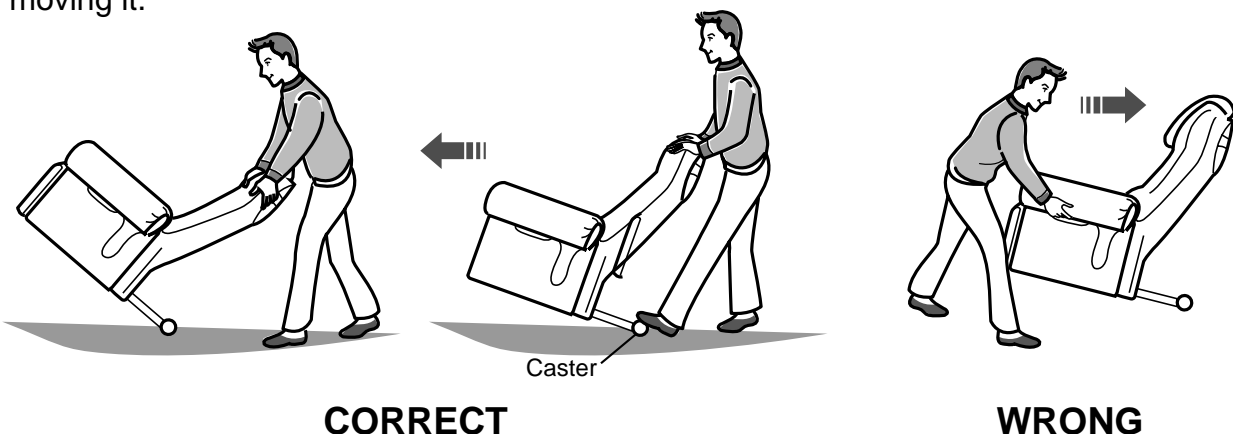

PARTS IDENTIFICATION

MASSAGE LOUNGER

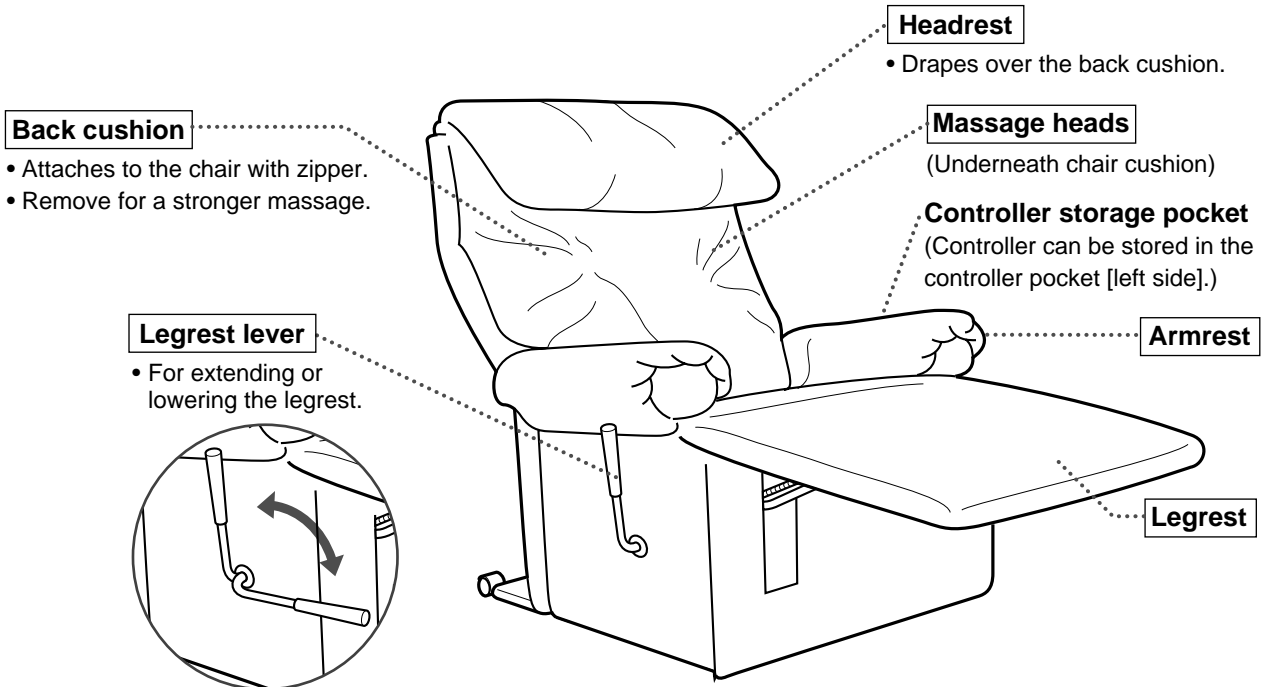

CONTROLLER

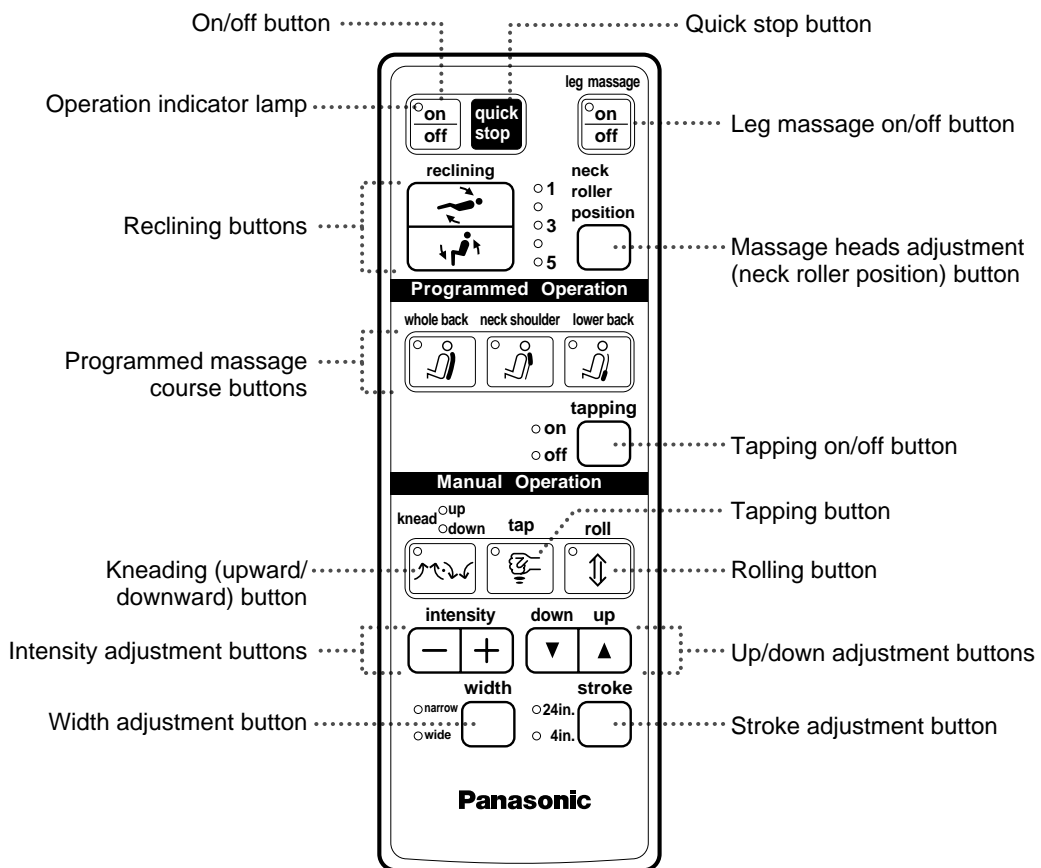

BEFORE USE

PLACE OF USE

- Do not use the massage lounger where it will be exposed to direct sunlight for long periods of time. Overexposure to harsh light can discolor or harden the cover.
- Do not use the massage lounger in hot or humid places or places where it may become wet from rain, splashing or dripping water, etc. Water and heat can cause discoloring and mildew.

NOTE:

Position the chair at least 16 in. (40 cm) away from any wall or other obstacle to ensure adequate reclining space.

TURNING ON THE POWER

First read and familiarize yourself with the safety precautions.

1. Plug the power cord into the inlet located at the rear of the chair.
2. Plug the power cord into an AC outlet.

NOTE:

Be careful not to pinch the cord under the leg frames of the chair or any other objects.

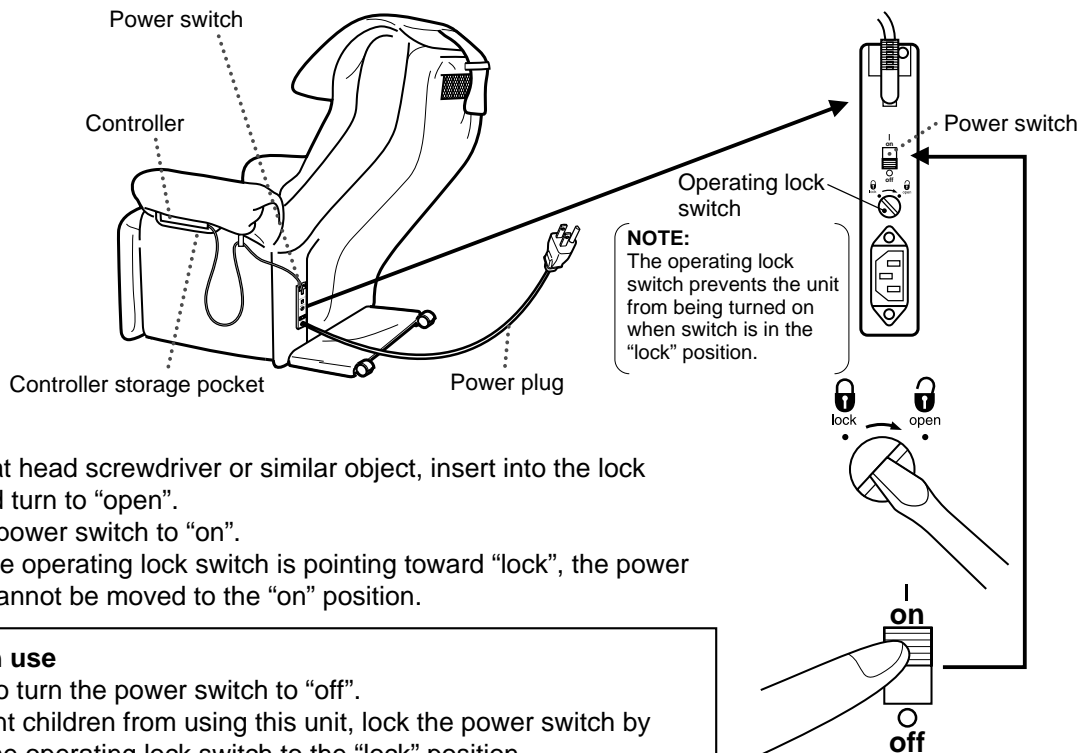

3. Using a flat head screwdriver or similar object, insert into the lock switch and turn to "open".
4. Move the power switch to "on".
 - When the operating lock switch is pointing toward "lock", the power switch cannot be moved to the "on" position.

After each use

- Be sure to turn the power switch to "off".
- To prevent children from using this unit, lock the power switch by moving the operating lock switch to the "lock" position.
- As a further precaution, unplug the power cord from the outlet after each use.

BEFORE SITTING DOWN

Do not exceed the maximum user weight of 264 lbs. (120 kg).

Before sitting down, you must first check the position of the massage heads with your hands.

- The massage heads should be spread apart near the top of the massage lounger backrest in the resting position.
- If the massage heads are not in their resting position, do not sit down in the massage lounger. Press the "on/off" button on the controller twice. Wait for the massage heads to reach the resting position before sitting down.
After making sure the massage heads are in the resting position, sit down slowly in the center of the massage lounger.

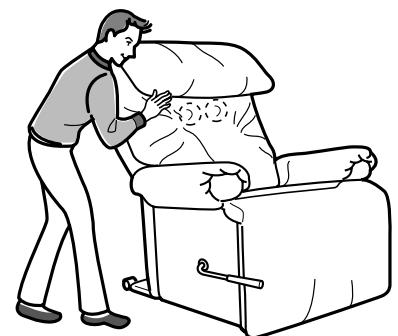

RECLINING THE CHAIR

By using the reclining button on the controller, the legrest can be raised and lowered automatically in concert with the movement of the massage lounger's backrest.

- To avoid possible tipping of the chair, do not sit or lean on the backrest while chair back is in a reclined position.
- The angle of the chair back can be changed so that the body weight and the massage heads will work together to determine the strength of the massage.
- Try changing the angle of the chair back to find a comfortable massage of a strength that is most suitable for you. The more you recline, the more intense the massage will feel. Adding or removing the cushion insert pad will also increase the intensity.

NOTE:

Position the chair at least 16 in. (40 cm) away from any wall or other obstacle to ensure adequate reclining space.

To extend: Press and hold the  button.

- While the button is pressed and held, the legrest will extend and the backrest will recline.
- Release the button when the desired position has been reached.

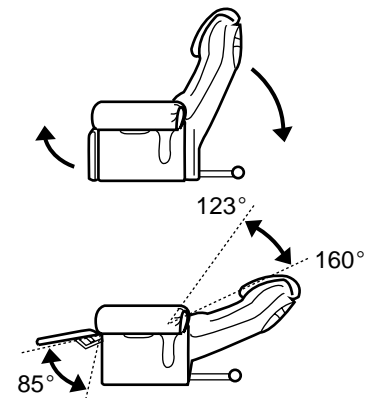
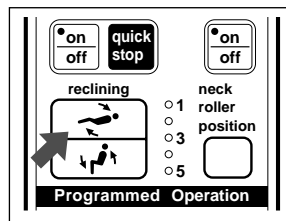

To lower: Press and hold the  button.

- The legrest will be returned to its resting position and the backrest will be raised.
- To obtain the maximum benefit from the massage, let your body relax and recline in a comfortable manner.

NOTE:

After use, always be sure to return the legrest and backrest to their resting positions (legrest lowered and backrest raised).

HOW TO EXTEND THE LEGREST MANUALLY

By using the legrest lever on the side of the massage lounger, the legrest can be raised and lowered independently from the chair back.

To extend: Pull the lever back.

- Pull the lever back as far as it will go (until the lock catches).
- The legrest can be raised to 90°.

To lower: Push forward on the lever.

- When extending or lowering the legrest, lift your legs off of the legrest and operate the lever.
- The legrest cannot be lowered completely if the massage lounger's backrest is not raised completely. (The same condition occurs for lever operation.)
- The legrest will be locked in position when it is raised using the legrest lever; therefore, the legrest cannot be lowered using the reclining button on the controller. Always use the legrest lever to lower the legrest if it has been raised by the legrest lever.

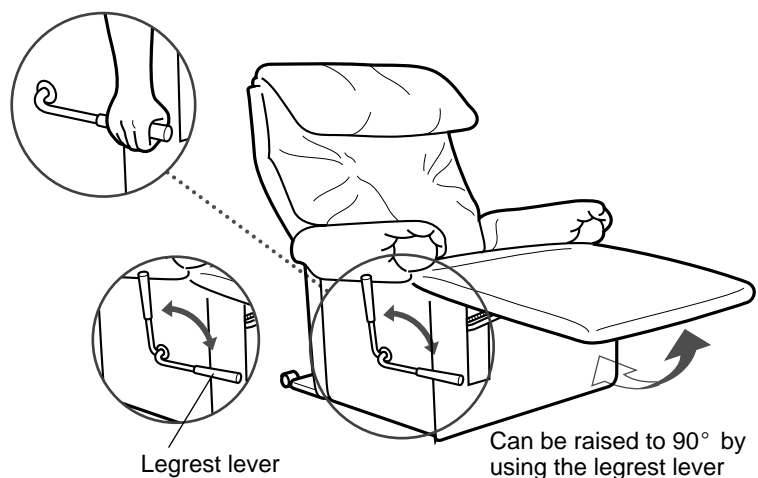

NOTE:

- When lowering the legrest, keep children and pets away from the massage lounger to prevent injury.
- Be aware that during powered reclining the legrest lever will move automatically.

HOW TO USE

TO START/STOP MASSAGE ACTION

Before using, first read all the instructions including the warnings and safety and operating precautions, as well as the section on programmed and manual massage.

1. To operate the massager, press the “on/off” button.
 - Check to be sure that the operation indicator lamp is lit.
2. To stop the massager during operation, press the “on/off” button.

The message heads will go up, spread out and stop in their resting position.

 - Check to be sure that the operation indicator lamp goes out.
 - With the heads in their resting position, you can sit comfortably, using the massager as a regular lounge chair.
 - To resume the massage, press the “on/off” button. The message action or programmed message course will start from the beginning.
 - Be sure to store the controller in the pocket on the side of the left armrest when not in use.

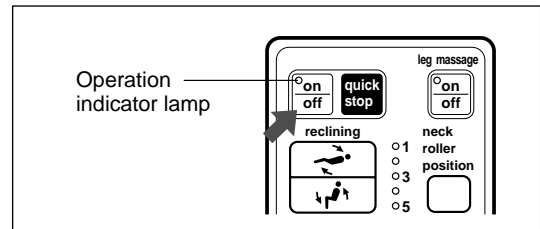

Quick stop button

If you wish to stop the massage immediately, press the “quick stop” button.

The message heads will stop where they are.

- Check to be sure that the operation indicator lamp goes out.
- To resume the massage, press the “on/off” button. The message action or programmed message course will start from the beginning.
- To return the message heads to the resting position, press the on/off button, wait, then press it again. The message heads will then stop in a retracted resting position more comfortable for sitting.

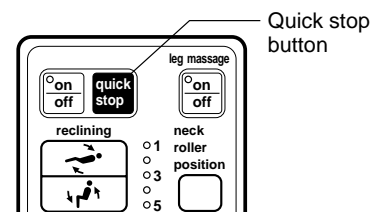

Automatic timer for massage lounger

- To prevent excessive massage, there is a built-in timer which, after approximately 15 minutes of operation, will automatically return the message heads to their resting position and stop their motion.
- Turning on the on/off button while the message heads are moving to their resting position will reset the time for another 15 minutes (approximately).
- If the programmed massage button is pressed, the unit will stop after finishing the program.

LEG MASSAGER OPERATION

1. Press the leg massage “on/off” button to turn on the leg massager.
 - Check to be sure that the operation indicator lamp on the leg massage on/off button is lit.
2. To turn off the leg massager, press this leg massage on/off button again.

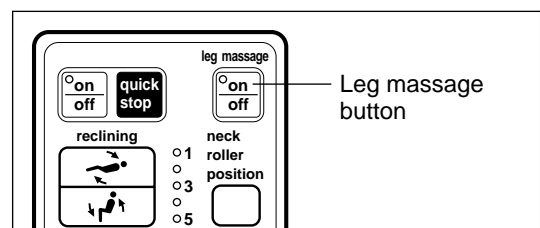

Automatic timer for leg massager

- To prevent continuous operation of the leg massager, there is a built-in timer that will automatically turn off the leg massager after 30 minutes of operation.

PROGRAMMED MESSAGE

First read and familiarize yourself with the safety and operating precautions.

1. Press the “on/off” button.
2. Use the “massage heads adjustment” button (neck roller position) to toggle from the highest (tallest) setting “1” to the lowest (shortest) setting “5”, in order to set the massage heads to the desired position for your neck.

Massage heads (rollers) should rest comfortably at the top of your shoulders prior to the start of the massage.

- This button is to limit the height of the massage heads against your neck and head. We recommend that a person who is 6 ft. (1.82 m) or taller use the setting “1”, while a person who is 5 ft. (1.52 m) or shorter use the setting “5”.
- Once you have made the adjustment, you can select any massage setting you like.
- You can adjust the massage head position anytime during massaging.

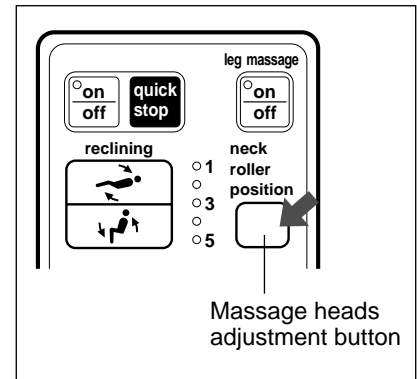

3. Press the desired programmed massage course button for the area of the body you want to have massaged. (See page 16 for details on the different massage courses.)
 - Check to be sure that the course indicator lamp is lit.

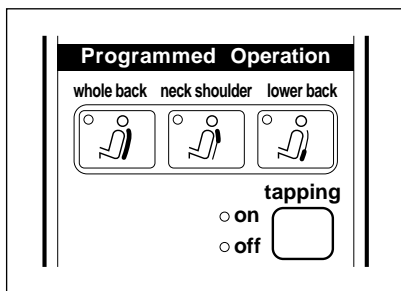

- Whole back:** Massages the whole back. See message course on page 16.
- Neck shoulder:** Massages primarily the neck and shoulders. See page 16.
- Lower back:** Massages primarily the lower back. See page 16.

- If you do not press any button, the whole back course will start automatically about 40 seconds after you turn on the massager.
- Massage will operate for approximately 15 minutes after pressing the button.
- If you want to change the massage course, press the button of the desired course.
- You may change the massage course at any time during operation without harm.
- Your new instructions will override any previous ones.

FOR THOSE WHO WISH TO HAVE A MESSAGE WITHOUT TAPPING

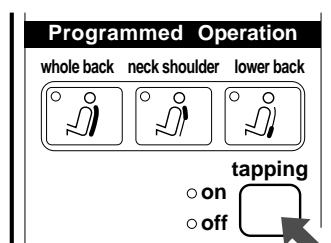

1. Press the “tapping” button when you do not want tapping in the middle of the programmed massage course. (The tapping movement changes into kneading.)
2. Press the tapping button again to re-activate.

MANUAL MASSAGE

First read and familiarize yourself with the safety and operating precautions.

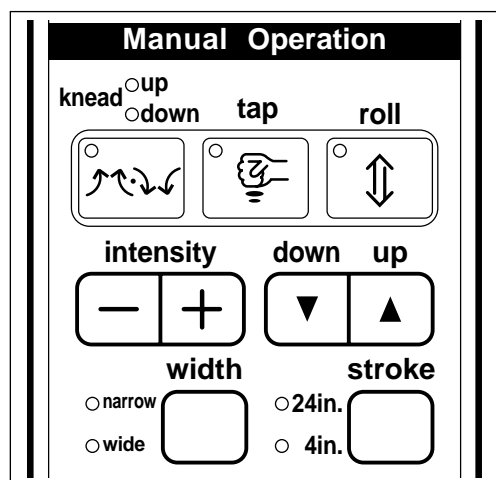

Press the button for the desired massage.

- The currently operating massage is indicated by the massage indicator lamps.
- It is possible to combine different massage types.

 Kneading (upward/downward) massage





 Tapping massage

 Rolling massage





NOTE:

- Do not massage any one point for more than 5 minutes.
- Do not stretch the back muscles for more than approximately 15 minutes at one time. A continuous massage in the same area may result in soreness.





Kneading massage (upward & downward)

1. Press the "knead"  button. Each time you press the knead button, the kneading direction alternates between upward and downward.
2. To raise the massage heads, press the "up"  button. To lower them, press the "down"  button.
3. To adjust the intensity of massage, press the "intensity"  buttons.

Tapping massage





1. Press the "tap"  button.
The massage heads move to the narrowest position and start the tapping massage.
2. Press the "width" adjustment button to select the width of the massage heads (narrow or wide).
3. To raise the massage heads, press the "up"  button. To lower them, press the "down"  button.
4. To adjust the intensity of massage, press the "intensity"  buttons.

Rolling massage

1. Press the "roll"  button.
The massage heads move to the narrowest position and start the rolling massage.
2. Press the "width" adjustment button to select the width of the massage heads (narrow or wide).
3. To raise the massage heads, press the "up"  button. To lower them, press the "down"  button.
 - All functions that include rolling are available for the entire back, or for a limited section of the back, by pressing the "stroke" adjustment button.
4. To adjust the intensity of massage, press the "intensity"  buttons.

MANUAL MASSAGE





Kneading rolling massage

1. Press the "knead"  button and the "roll"  button.
The massage heads start the kneading rolling massage.
2. To raise the massage heads, press the "up" ▲ button. To lower them, press the "down" ▼ button.
 - All functions that include rolling are available for the entire back, or for a limited section of the back, by pressing the "stroke" adjustment button.
3. To adjust the intensity of massage, press the "intensity"   buttons.

NOTE:

When using a two function massage on manual mode, you can eliminate one function by pressing on that function's control button. Thus, it is okay to change from kneading/rolling to just kneading by hitting the rolling button or to just rolling by hitting the kneading button once to toggle it off.







Tapping rolling massage

1. Press the "tap"  button and the "roll"  button.
The massage heads move to the narrowest position and start the tapping rolling massage.
2. Press the "width" adjustment button to select the width of the massage heads (narrow or wide).
3. To raise the massage heads, press the "up" ▲ button. To lower them, press the "down" ▼ button.
 - All functions that include rolling are available for the entire back, or for a limited section of the back, by pressing the "stroke" adjustment button.
4. To adjust the intensity of massage, press the "intensity"   buttons.

NOTE:

When using a two function massage on manual mode, you can eliminate one function by pressing on that function's control button. Thus, it is okay to change from tapping/rolling to just tapping by hitting the rolling button or to just rolling by hitting the tapping button once to toggle it off.

Adjustability for Manual Massage

Adjustability Manual Mode	Up/Down Adjustment	Intensity Adjustment	Width Adjustment	Stroke Adjustment
	<input type="radio"/> 23 5/8" (600 mm)	<input type="radio"/> 1 3/4" (45 mm)	×	×
	<input type="radio"/> 23 5/8" (600 mm)	<input type="radio"/> 1 3/4" (45 mm)	<input type="radio"/> 3 5/16" or 4 5/16" (85 or 110 mm)	×
	<input type="radio"/> 23 5/8" (600 mm)	<input type="radio"/> 5/8" (15 mm)	<input type="radio"/> 3 5/16" or 4 5/16" (85 or 110 mm)	<input type="radio"/> 4 3/4" or 23 5/8" (120 or 600 mm)
 	<input type="radio"/> 23 5/8" (600 mm)	<input type="radio"/> 5/8" (15 mm)	×	<input type="radio"/> 4 3/4" or 23 5/8" (120 or 600 mm)
 	<input type="radio"/> 23 5/8" (600 mm)	<input type="radio"/> 5/8" (15 mm)	<input type="radio"/> 3 5/16" or 4 5/16" (85 or 110 mm)	<input type="radio"/> 4 3/4" or 23 5/8" (120 or 600 mm)

○: possible, ×: not possible

Massage heads up-down adjustment

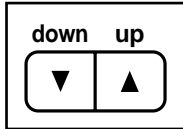

Use of the up or down adjustment button allows you to adjust the up and down direction of the massage heads.

To move the massage heads up, press and hold the "up" ▲ button. To lower them, press the "down" ▼ button. You must hold the button down until you reach the spot you want.

Massage heads width adjustment (See page 17.)

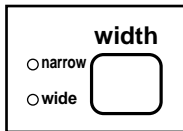

Use of the width (narrow or wide) adjustment button allows you to select the width between the massage heads (available only in the tapping, rolling, and tapping rolling massage modes).

Press the "width" button to change the width.

Massage stroke adjustment

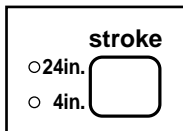

Use of the stroke adjustment button allows you to select the focus area of the massage strokes (available only in the rolling, kneading rolling, and tapping rolling massage modes).

Press the "stroke" button to change the stroke.

NOTE:

- Switches between regional and full:
24in.: Approx. 23 5/8 in. (600 mm)
4in.: Approx. 4 3/4 in. (120 mm)
- When "4in." is selected, you can adjust the height of the massage heads to the desired position with the up/down adjustment buttons.

Massage intensity adjustment

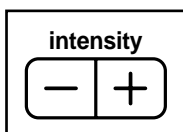

Use of the intensity adjustment buttons allows you to adjust the intensity of the massage during manual operation for kneading (upward/downward), tapping, rolling, kneading rolling, and tapping rolling massage modes.

Press and hold the intensity adjustment button to choose the desired massage intensity.

NOTE:

- When you adjust the massage intensity, the massage heads' position may change.
- The massage heads stop automatically when they reach the maximum or minimum intensity positions. When you release your finger from the button, operation will resume.

BACK CUSHION AND HEADREST

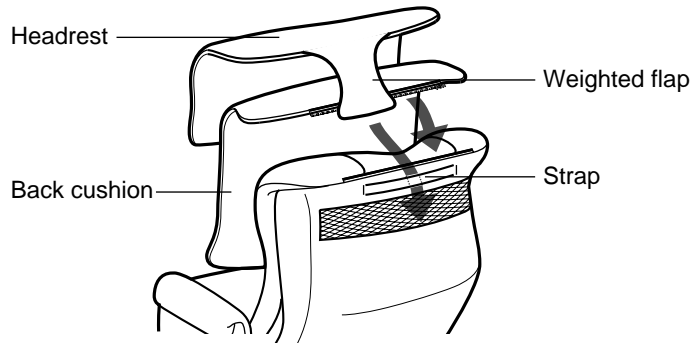

- Fasten the back cushion to the chair and the headrest and insert the weighted flap through the strap attached behind the chair.
- If you prefer a stronger massage, remove the back cushion.
- When the massage function will be used, remove the headrest or flip the headrest over the back of the chair before starting the massage.

NOTE:

- This massage lounger is capable of providing a vigorous “shiatsu” massage. The rolling and tapping action are very strong, and this type of massage may be too strong for people who have not previously experienced a shiatsu massage. For this reason, a foam cushion insert pad is provided to soften the effect of the massage.
- The cushion insert pad can be removed for a full shiatsu massage, but be aware of the intensity of the massage you will receive. The first time you try it – if you decide to – sit in a relaxed manner and do not use it for more than two minutes. After that you should be able to decide whether or not you prefer a massage with the pad in place.

CUSHION INSERT PAD

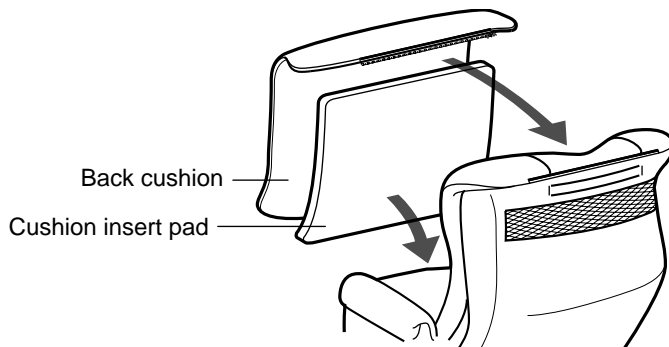

- This pad is placed underneath the back cushion at the waist position for supporting the back and the waist, and for overall chair comfort.
- Remove if unwanted during a massage.

DETAILS OF PROGRAMMED MASSAGE

Whole back course

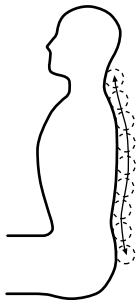

Complete massage including neck, shoulders, back stretching and lower back

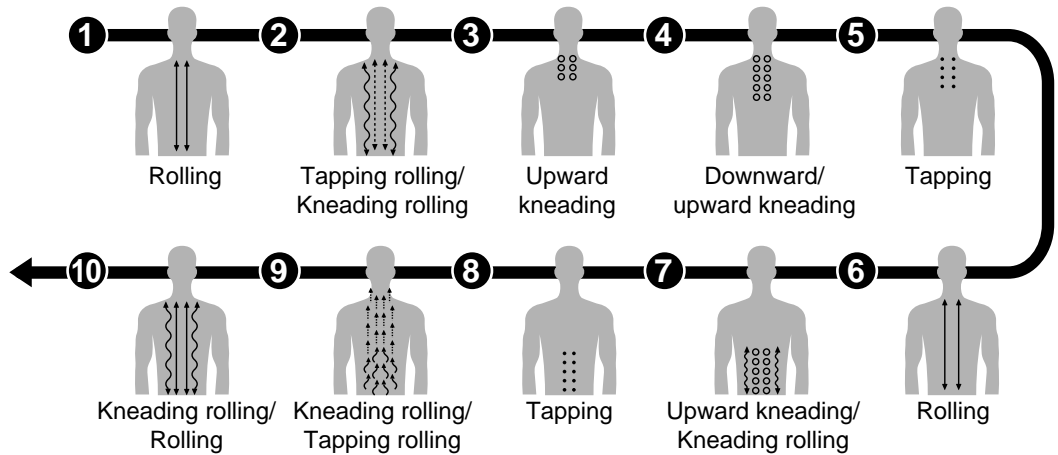

Neck and shoulder course



Concentrated massage of neck and shoulders

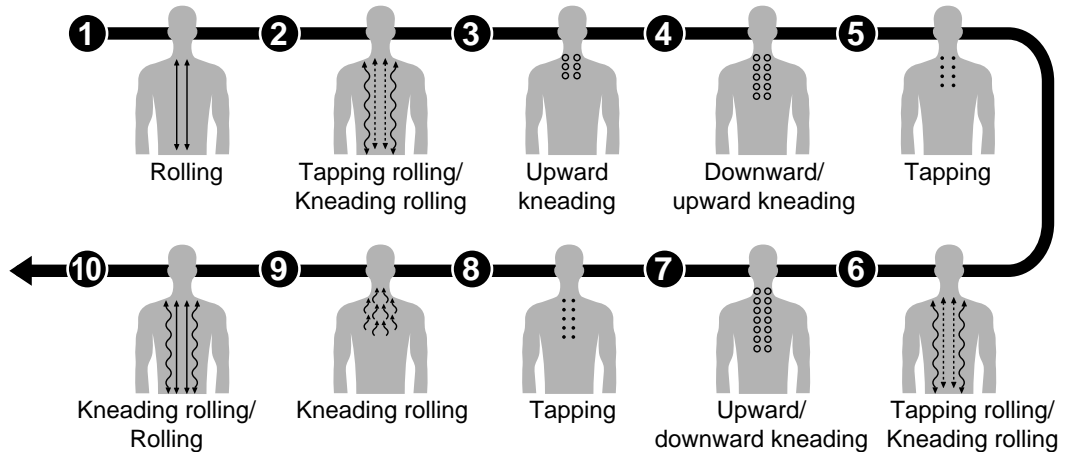

Lower back course

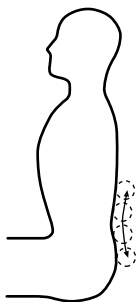

Concentrated massage of lower back

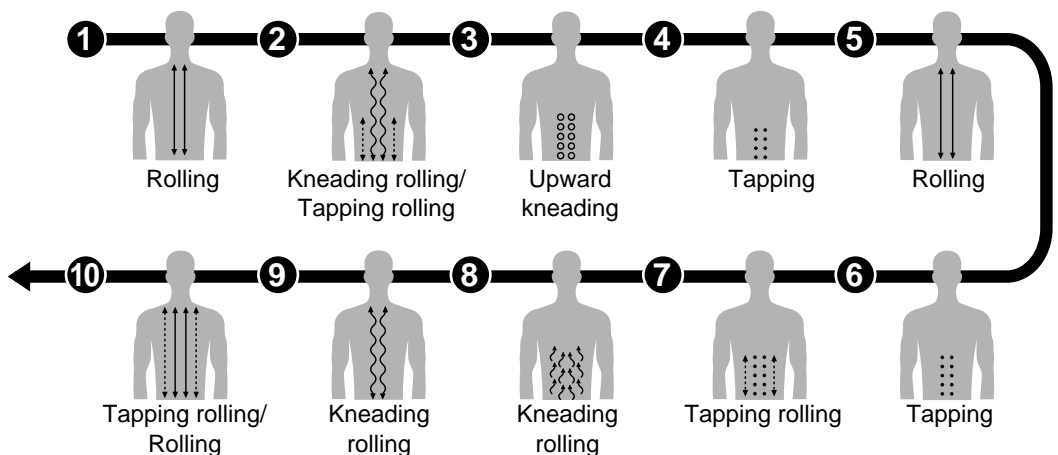

* The above diagrams have been abbreviated to allow easy understanding of the massage action.

MASSAGE HEADS' RANGE OF MOVEMENT

- The vertical movement of the massage heads can be set for different areas, giving you a massage any place you like from the neck to the lower back for all massage types.

Kneading (upward/downward), Kneading rolling, and Regional kneading rolling.

Massage range width: 2 15/16 in. (75 mm) (width cannot be adjusted)

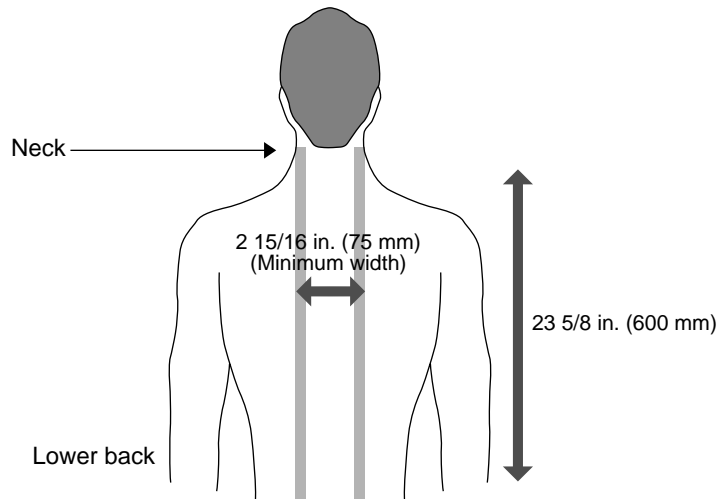

Tapping, Rolling, Regional rolling, Tapping rolling, and Regional tapping rolling

Massage range width: 3 5/16 in. or 4 5/16 in. (85 mm or 110 mm)

The width (distance) between the massage heads can be adjusted in two ranges.

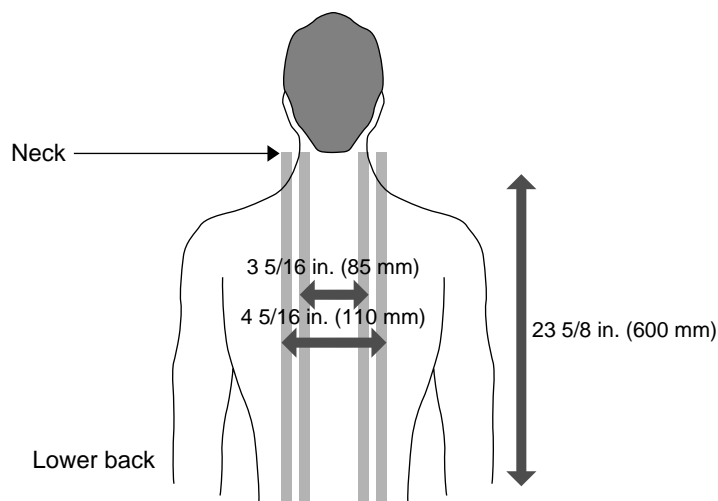

TROUBLESHOOTING GUIDE

Before requesting service for this unit, check the table below for the possible cause of the problem. Some simple checks or minor adjustment on your part may eliminate the problem and restore proper operation. If you are in doubt about some of the check points, or if the remedies indicated in the chart do not solve the problem, call us at 1-800-338-0552 to locate the servicer near to you.

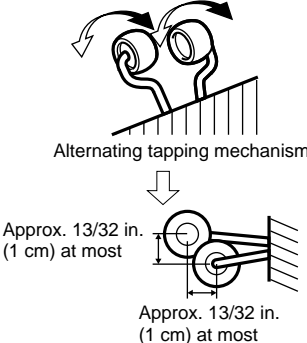
Problem	Probable cause(s)	Suggested remedy
Massage does not start.	The power cord is not plugged in.	Plug the power cord into an AC outlet (120 V).
	The power switch is at the "off" position.	Slide the power switch to "on".
	The operating lock switch is set to "lock" position.	Set the operating lock switch to "open".
	During reclining if any force or resistance is encountered, such as the chair hitting an obstacle, the chair may stop for safety.	Remove any obstacles. If the leg massage operation indicator lamp on the controller blinks and the chair stops, turn off the power switch and then turn on after 10 seconds. Then, press the "on/off" button on the controller to start the massage.
	During operation if the chair encounters any force or resistance, the massage heads stop for safety.	Raise your back slightly from the massage heads. If all operation indicator lamps on the controller blink and the chair stops, turn off the power switch and then turn on after 10 seconds. Then, press the "on/off" button on the controller to start the massage.
Kneading massage cannot be changed immediately to a rolling massage.	The massage heads must move to the narrowest position for a rolling massage.	Wait until the massage heads reach the narrowest position.
Massage heads do not reach your shoulders.	Your shoulders are too high.	Shift your waist forward and recline the chair back.
It seems as if the massage heads are at different heights.	This is because an alternating tapping mechanism is used. It is not a malfunction.  When stopped, the misalignment is approx. 13/32 in. (1 cm) at most.	Press the "tap" button in the manual operation mode. Then press the "quick stop" button to turn off the tapping. Check under the back cushion and cushion insert pad with your hands to see whether the massage heads have stopped in an aligned position. If not, repeat this process until the massage heads are aligned when stopped.

SPECIFICATIONS

Power source:	120 V AC, 60 Hz
Power consumption:	200 W
Kneading speed:	Approx. 28 times/min.
Tapping speed:	Approx. 500 times/min. (per side)
Rolling massage speed:	Approx. 1 cycle every 37 sec.
Massage width:	Shoulder / lower back section: Approx. 2 15/16 in. (75 mm)
Back rolling width/tapping width:	Narrow: Approx. 3 5/16 in. (85 mm) Wide: Approx. 4 5/16 in. (110 mm)
Massage heads up/down travel:	Approx. 23 5/8 in. (600 mm)
Regional back rolling:	Automatic repetition within approx. 4 3/4 in. (120 mm) range
Intensity adjustment:	Adjusts massage head protrusion steplessly within approx. 1 3/4 in. (45 mm) range.
Shoulder position adjustment:	5 steps
Automatic shut-off:	Approx. 15 min.
Dimensions (H x W x D):	Not reclined with legrest lowered: 41 11/32 x 34 41/64 x 40 35/64 in. (1050 x 880 x 1030 mm) Reclined with legrest extended: 29 9/64 x 34 41/64 x 68 7/64 in. (740 x 880 x 1730 mm)
Reclining angle:	Approx. 123° to 160°
Weight:	121 lbs. (55 kg)
Accessories:	Back cushion, headrest, cushion insert pad
Maximum user weight:	264 lbs. (120 kg). See precautions on page 5.