

This Owner's Manual is provided and hosted by [Appliance Factory Parts](#).



# PANASONIC EP3202 Owner's Manual

[Shop genuine replacement parts for PANASONIC  
EP3202](#)



[Find Your PANASONIC Massage Lounger Parts - Select From 25 Models](#)

----- Manual continues below -----

# Panasonic®

Household  
Massage Lounger  
Sillón de masaje para casa  
Fauteuil vibromasseur

## Operating Instructions Instrucciones de uso Mode d'emploi

Model No. **EP3203/EP3202**

Modelo No. **EP3203/EP3202**

N° de modèle **EP3203/EP3202**



Before operating this unit, please read these instructions completely, and save for future reference.

Antes de utilizar esta unidad, lea completamente estas instrucciones y guárdelas por si necesita consultarlas en el futuro.

Avant d'utiliser cet appareil, nous vous recommandons de lire l'ensemble de ces instructions et de les ranger dans un endroit accessible pour une consultation ultérieure.

WEP3203L8108

Thank you for purchasing the Panasonic Household Massage Lounger EP3203/EP3202. Please read this manual carefully to ensure optimum performance and safety.

## **IMPORTANT SAFETY INSTRUCTIONS**

Basic precautions should always be followed when using an electrical unit, including the following.

Please ensure that you read all instructions before using the Household Massage Lounger.

### **DANGER** – To reduce the risk of electric shock:

1. Always unplug the unit immediately after use.
2. Always unplug the unit before cleaning.

### **WARNING** – To reduce the risk of burns, fire, electric shock, or injury to persons:

1. Always insert the power plug all the way into the outlet to reduce the risk of short-circuit and fire.
2. The unit should never be left unattended when plugged in. Always unplug the unit when not in use.
3. Close and continuous supervision is necessary when the unit is used by people who are limited in their ability to move or communicate.
4. Only use the unit for the purpose described in these instructions.
5. Do not stand on the unit.
6. Do not use any accessories other than those recommended by the manufacturer.
7. This unit should not be used by children. Keep children away from the unit. Always return the seat to the upright position and retract the legrest completely to avoid possible injury. Make sure that nothing is in the way when retracting the legrest.
8. Never operate the unit if it has a damaged power cord or plug. Return the unit to the nearest authorized service center if it is not working properly, if it has been dropped or damaged, or if it has been immersed in water.
9. Always raise the back cushion to check that the fabric of the unit itself has not been ripped before using the unit. Please also check other areas to ensure that the fabric has not been ripped. No matter how small the rip, if you find one then immediately stop using the unit, unplug the power cord and have the unit repaired at an authorized service center.
10. Keep power cords away from heated surfaces. Do not carry the unit by the power cord. Do not allow pins, rubbish or moisture to come into contact with the plug.
11. Do not use the unit on top of heating appliances, such as electric carpets, etc.
12. Never block the air openings during operation and make sure that all air openings are kept free of lint and hair, etc. Do not drop or insert anything into any of the openings of the unit.
13. Do not use the unit in bathrooms or other damp or humid places as this may cause electric shock or cause the unit to malfunction. Do not spill water, etc. onto the control panel.
14. Do not use the unit outdoors.
15. Do not use the unit in places where aerosol spray products are in use or where oxygen is being used.
16. When unplugging the unit, turn off all controls before removing the plug from power outlet. Do not use the unit with a transformer as this may lead to malfunction or electric shock.
17. Connect this unit to a properly grounded outlet only. See Grounding Instructions.
18. To avoid electric shock or injury, do not attempt to open or disassemble any part of the unit as it contains no user-serviceable parts.

## **SAVE THESE INSTRUCTIONS**

# SAFETY PRECAUTIONS

## WARNING: To avoid the risk of injury:

1. Pregnant women, people who are ill, in poor physical shape or undergoing medical treatment, and people suffering from back, neck, shoulder or hip pain should consult their doctor before using the unit. If you have a pacemaker, defibrillator, or other personal medical device, consult with the manufacturer of your device before using the unit. Your physician may be able to assist you in obtaining this information.
2. Sit down slowly after checking the position of the massage heads. Never put any part of your body between the massage heads as the squeezing action of the massage heads may cause injury. Never put your fingers or feet in the gap between the backrest and seat, the backrest and the armrest, the seat and cover under the armrest, or the gap between the legrest and the footrest. Do not place your fingers or any part of your body in the mechanism below the legrest, or between the legrest and footrest.
3. Do not use the unit against bare skin. While thin clothing may increase effectiveness, exposing the skin directly to the massager may irritate the skin.  
Do not use the unit while wearing anything hard on your head like a hair accessory, etc.
4. Do not use the unit for massaging the head, abdomen, front neck, elbows or knees. Do not use excessively strong massage action on the back of the neck.
5. When using the body searching function, always ensure that the shoulder position is correct. If the shoulder position is not correct, use the Neck Roller Position Adjustment Button to adjust it properly. You can adjust the shoulder position in this way in the Programmed Operation, Self Program and Rolling in the Manual Operation. Failure to align the shoulder position correctly can lead to injury.
6. Do not stretch the back muscles for more than approximately 15 minutes at a time. To avoid overstretching the muscles which may result in discomfort, do not use the unit for more than 5 minutes when first using it. You can gradually increase the duration and strength of the massage as you become used to it.  
Do not massage any one point for more than 5 minutes at a time.  
Excessive massaging can overstimulate the muscles and nerves and result in an adverse effect.  
To prevent excessive massaging, do not use the massager for more than a total of 15 minutes each session. After approximately 15 minutes, the massage heads will be retracted and stop moving. The back cushion can be removed if you want to experience a stronger back massage. Exercise extreme care when you use this mode in order to avoid back pain or injury. Use only for short periods of time (no more than 15 minutes). Reinstall the back cushion if you want to restore to normal massage intensity.
7. While using the massager, if you start feeling sick or if the massage seems painful, stop using it immediately. While using the massager, if the pressure seems too strong, the movement of the massage heads can be stopped at any time by pressing the Quick Stop Button.
8. Do not go to sleep while using the unit. Do not use the unit after drinking alcohol.
9. When the seat back is in a reclined position, do not sit on it or sit with your legs resting on the headrest. Do not sit on the legrest as the unit may fall over.
10. Do not allow children or pets to play on or around the unit, especially during operation.
11. Do not unplug the unit or turn it off during operation. Unplug the unit immediately if there is a power outage.
12. Be sure to start on the gentle massage program if using the massager for the first time. The shiatsu massage is stronger and should be enjoyed after one has gotten accustomed to the chair.
13. Do not allow children to play on this mechanized furniture or operate the mechanism. Legrest folds down on closing so that a child could possibly be injured. Always leave in an upright and closed position. Keep hands and feet clear of mechanism. Only the occupant should operate it.

# OPERATING PRECAUTIONS

## **WARNING: To avoid damaging the chair, follow these precautions:**

1. The chair is designed for a maximum user weight of 264lbs (120kg). Exceeding the maximum weight may cause permanent damage to the massage mechanism and/or other components of the unit. Any such damage is deemed to be user abuse and is not covered under the Limited Warranty.
2. Do not sit on or drop the control panel. Do not pull the control panel cord or the power cord. Be careful not to catch the cord of the control panel between the armrest and the chair back.
3. Do not treat the chair roughly, such as turning the chair on its side, turning the chair over or standing on it.
4. Do not treat the covering roughly.
  - Keep sharp or pointed objects away from the covering of the chair. Be careful not to drop lit ashes, lit cigarettes or matches on the chair.
  - Exposure to direct sunlight can cause fading or a change in color of the covering.
5. If the massager functions abnormally, immediately turn off the power and have the massager checked by an authorized service center.
6. Do not attempt to repair the massager yourself.
7. Do not repeatedly operate any switch at short intervals. Such action may cause the switch to malfunction.
8. Some noise may be heard coming from the massager while in use. This is due to the structure of the massager and is normal.
9. Make sure there are no obstacles behind the chair before reclining it. The chair can be reclined to a maximum angle of 170°. If the back hits a wall or pillar, the chair may malfunction. Be sure to have ample space behind the chair. Recline the chair slowly in order to avoid contact with an obstacle.
10. When excessive pressure is applied to the massage heads, they may stop moving for safety. When moving the heads up from the lowered position, one's body weight may stop the heads' movement. In such case, slightly raise your body and allow the massage heads to move up.
11. After each massage, slide the power switch, which is located on the right side of the chair, to the "off" position and turn its lock switch to the "lock" position.
12. Do not sit on the chair with wet body or hair.
13. The unit must not be used in "wet rooms" (sauna, swimming pool) or outdoors.

# GROUNDING INSTRUCTIONS

- The product must be grounded. If it should malfunction, grounding provides the path of least resistance for electric current to reduce the risk of electric shock.
- This product is equipped with a cord having an equipment-grounding conductor and a grounding plug. The plug must be plugged into an appropriate outlet that is properly installed and grounded in accordance with all local codes and ordinances.

## DANGER

- Improper connection of the equipment-grounding conductor can result in a risk of electric shock. Check with a qualified electrician if you are in doubt as to whether the product is properly grounded. Do not modify the plug provided with the product even if it does not fit the outlet. Have a proper outlet installed by a qualified electrician.
- This product is for use on a nominal 120-volt circuit and has a grounding plug that looks like the plug shown in Figure A. Make sure that the product is connected to an outlet having the same configuration as the plug. No adaptor should be used with this product.

**Figure A**

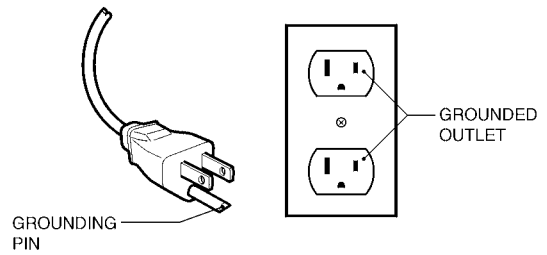

# BEFORE USING THE UNIT

## SETTING UP THE MASSAGE LOUNGER

After removing everything from the box, you should have the following

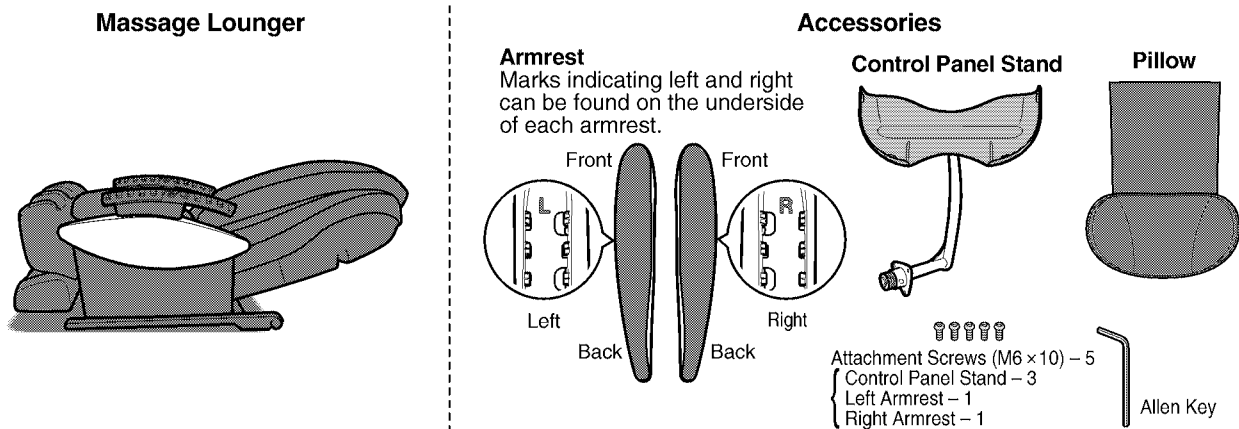

## Where to Use the Unit

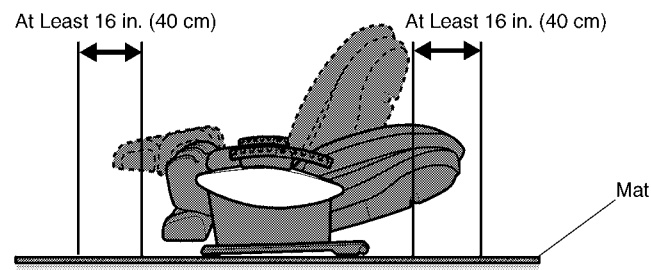

- Ensure there is adequate space for reclining
- Do not use the massage lounger in direct sunlight or in places where it will be exposed to high temperatures, such as in front of a heater, etc., as this can cause discoloration or hardening of the synthetic leather.
  - Place the unit on a mat to prevent floor damage.

**CAUTION**

- Do not use the unit in areas with high humidity, such as the bathroom, etc. as this can lead to electric shock or other accidents.
- Do not allow children to play on the unit. Doing so may lead to accidents or injury.
- Place the unit on a totally flat surface. Failure to do so may result in the seat tipping over.

## Attaching the Armrests

### 1. Insert the armrests into the seat.

- Marks indicating left and right can be found on the underside of each armrest.

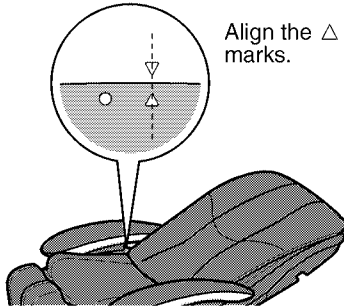

### 2. Push the armrest forward until it clicks into position.

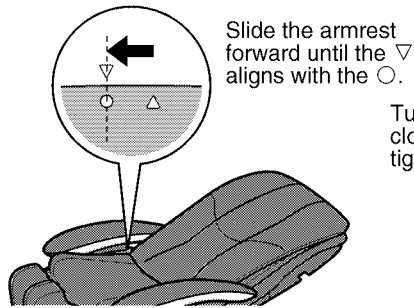

### 3. Insert the attachment screw into the hole and use the Allen key to secure it.

(Repeat the procedure for the armrest on the other side.)

Turn the screw clockwise to tighten it.

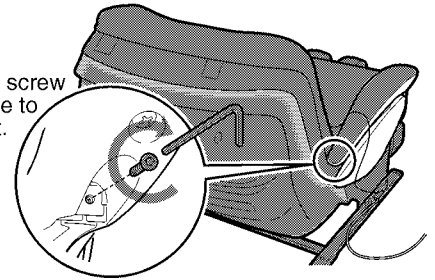

## Attaching the Control Panel Stand

Secure the control panel stand to the right hand side of the unit using the three screws provided.

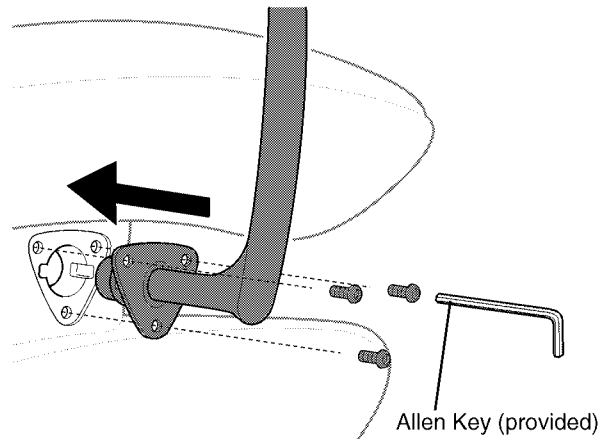

## Attaching and Removing the Control Panel

When attaching the control panel, slide it in from the top.

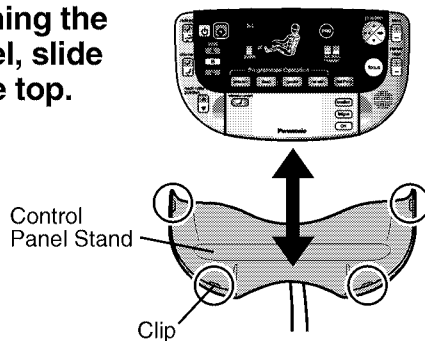

Slide the control panel up to remove it.

- Loosen the screw to situate the control panel stand at the desired angle, then tighten screw again. For smooth removal of the control panel, press on the back of the unit while sliding up.

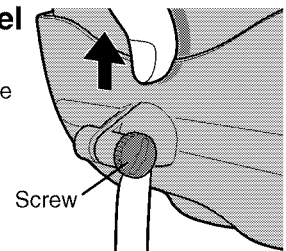



### Adjusting the Control Panel Stand

1. The control panel stand can rotate forward and back.

2. The angle can also be adjusted.

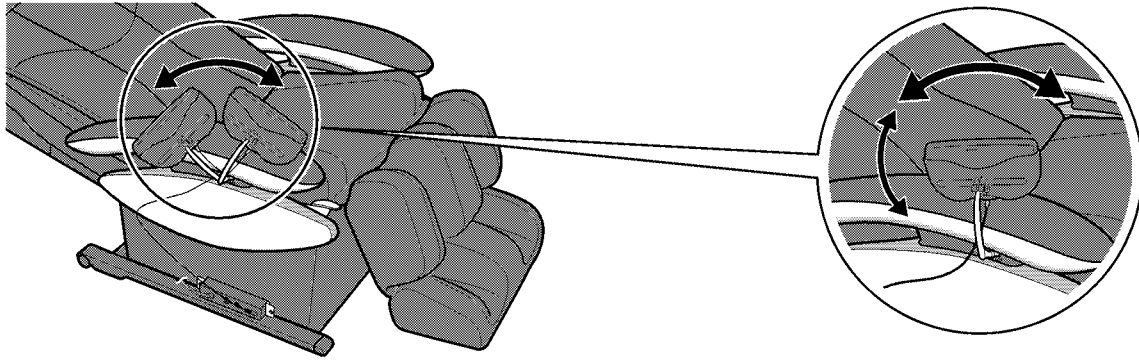

### Return the Backrest to the Upright Position

1. Plug the power plug into the power outlet.

2. Turn the lock switch to the “Open” position.

3. Turn on the power switch on the back of the unit.

4. Push  Twice (See Page 10)

- The backrest will return to the upright position automatically.
- The massage heads will move to the retracted position.

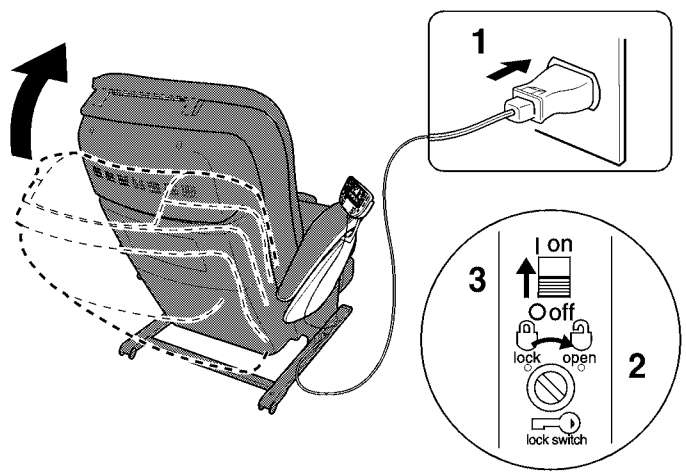

### Attaching the Pillow

Attach the pillow using the fasteners on the pillow and on the top of the backrest.

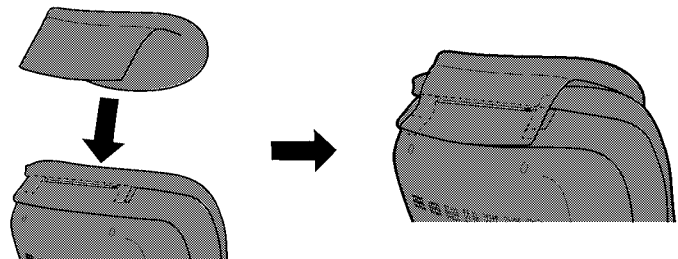

## BEFORE USING THE UNIT

### Please Check the Following Before Using the Unit

#### Check the Surrounding Area

- (1) Check that there is nothing around the unit.
- (2) Check that there is enough room (16 in.) to recline the unit.

#### Lower the Legrest Prior to Sitting Down.

- When the legrest is raised, press  to lower the legrest before sitting down.
- Do not sit on the legrest when it is raised. Doing so may cause it to collapse down or bend the ottoman. The ottoman is not meant to support full body weight.

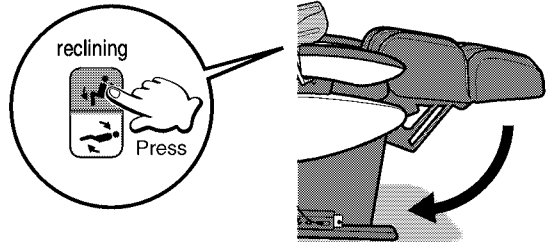

#### Adjust the Height of the Pillow

- Adjust the height of the pillow using the pillow fastener.
- Adjust the front part of the pillow so that it supports the back of the head and will not be too far down when massaging the neck.

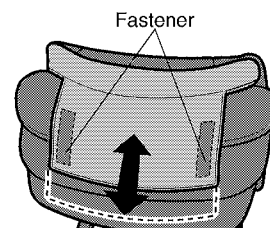

# PART NAMES AND FUNCTIONS

## Massage Lounger

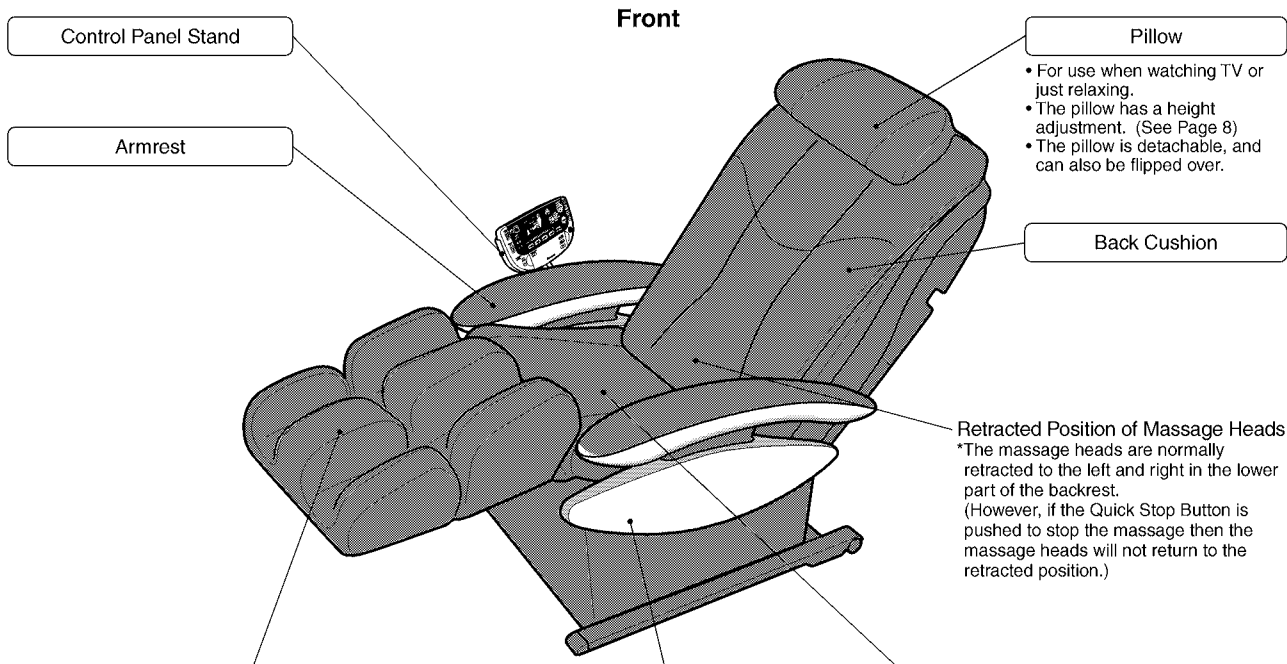

**Legrest**  
 • Includes an air massage function.

**When Lowered**

• Massages the calves and the soles of the feet.

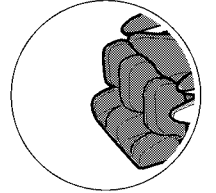

**When Raised**

• Massages the legs from the ankles to the knees.

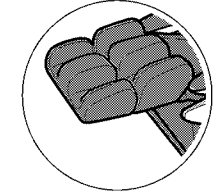

**Seat**  
 • Includes an air massage function.

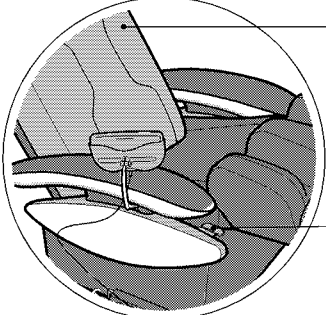

**Backrest**  
 (Contains massage heads.)

**Legrest Slide Lever**  
 • Used to slide the legrest in and out. (See Page 14)

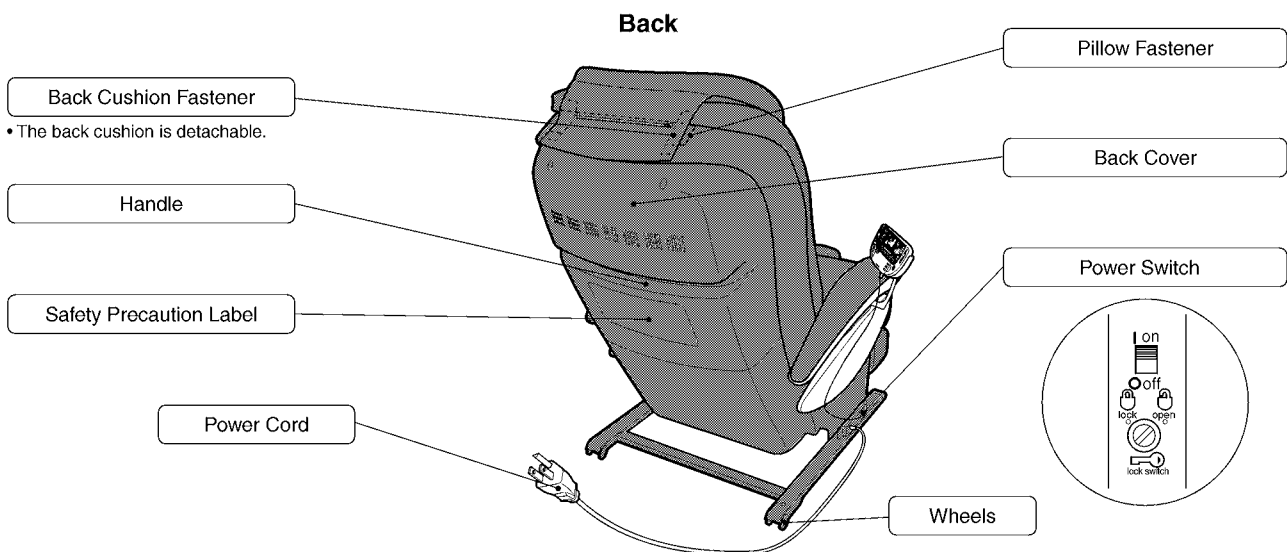

**Back Cushion Fastener**  
 • The back cushion is detachable.

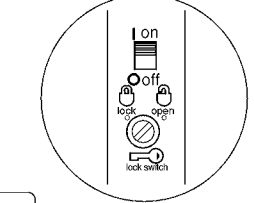

## CONTROL PANEL

### ON/OFF Button

- Press this button to start the massage and to stop it at any time during the massage.
- \* The massage heads will not move until you press one of the Programmed Operation buttons or Manual Operation buttons.
- \* If this button is pressed during the massage, the massage heads will move to the retracted position and both the backrest and the legrest will return to their original positions.

### Quick Stop Button

- Press this button to stop the massage immediately. (The massage heads will stop in the position they are in without retracting and air will be released from the legrest.)

### Voice Navigation Volume Switch (Located on the top side of the control unit.)

- Slide the switch to increase, decrease or cut voice navigation volume.
- \* Even when the volume is set to the OFF position you will still hear "beep" whenever you press one of the buttons.
- \* In the interests of safety the "beep-beep-beep" sound cannot be eliminated.

### Display

- The display shows the kind of massage selected.

### Reclining Button

- Use this button to adjust the angle of the backrest and legrest.

### Ottoman Button

- Use this button to adjust the angle of the legrest.

### Neck Roller Position Button

- Pressing this button allows the unit to adjust the shoulder position after searching the position of your body.

### Vibration ON/OFF Button (EP3203 only)

- Open the cover to manually select massage settings.

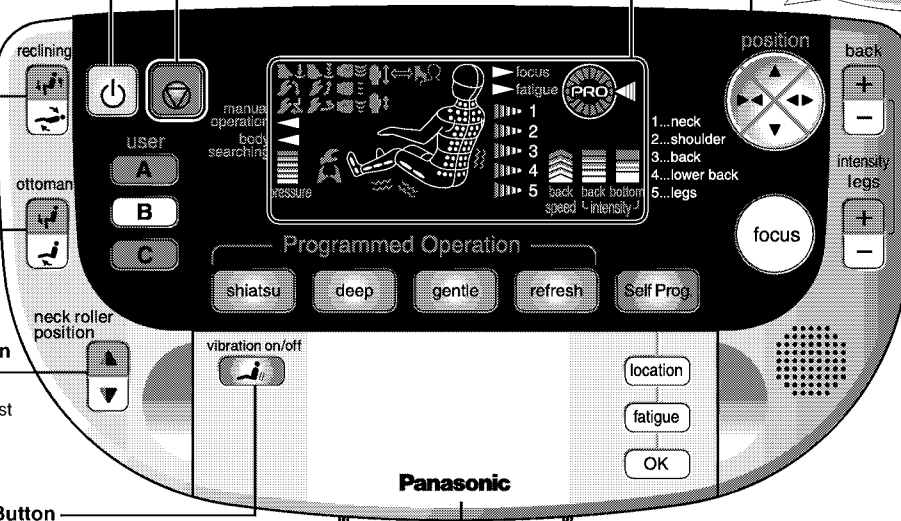

### Voice Navigation

This feature provides a simple explanation of operating procedures and massage settings.

#### Example

- Explanation of Operating Procedures  
"Please select a pre-programmed or self-programmed massage from one of the blinking controls".
- Explanation of Massage Settings  
"We will now scan your back". "The massage is starting".
- Explanation of Program  
"The Shiatsu program is the strongest program". (When Shiatsu program is selected.)

**Go to any one of the following sections if you want to start the massage lounge immediately.**

**When you want to use the massage lounge straight away.**

### PROGRAMMED OPERATION (shiatsu, deep, gentle, refresh)

This program is ideal for the following people:

- Those who feel tired all over.
- Those who want to operate the massager simply by using one of the 15 minute stored programs.

**When you want a massage suited to your degree of fatigue.**

### SELF PROGRAM

This program is ideal for the following people:

- Those who feel tired in different parts of their body.
- Those who want only their shoulders or legs massaged. This program allows the user to customize the massage. (See Page 15)

### USER ADJUSTMENT FUNCTIONS

**When you want more control over individual massage settings.**

### MANUAL OPERATION (open the control panel)

This program is ideal for the following people:

- Those who want to massage a certain area using a certain kind of massage.
- Those who want to make many different adjustments to massage settings.

# USING THE MASSAGE LOUNGER

## WHEN YOU WANT TO USE THE MASSAGE LOUNGER RIGHT AWAY. (PROGRAMMED OPERATION)

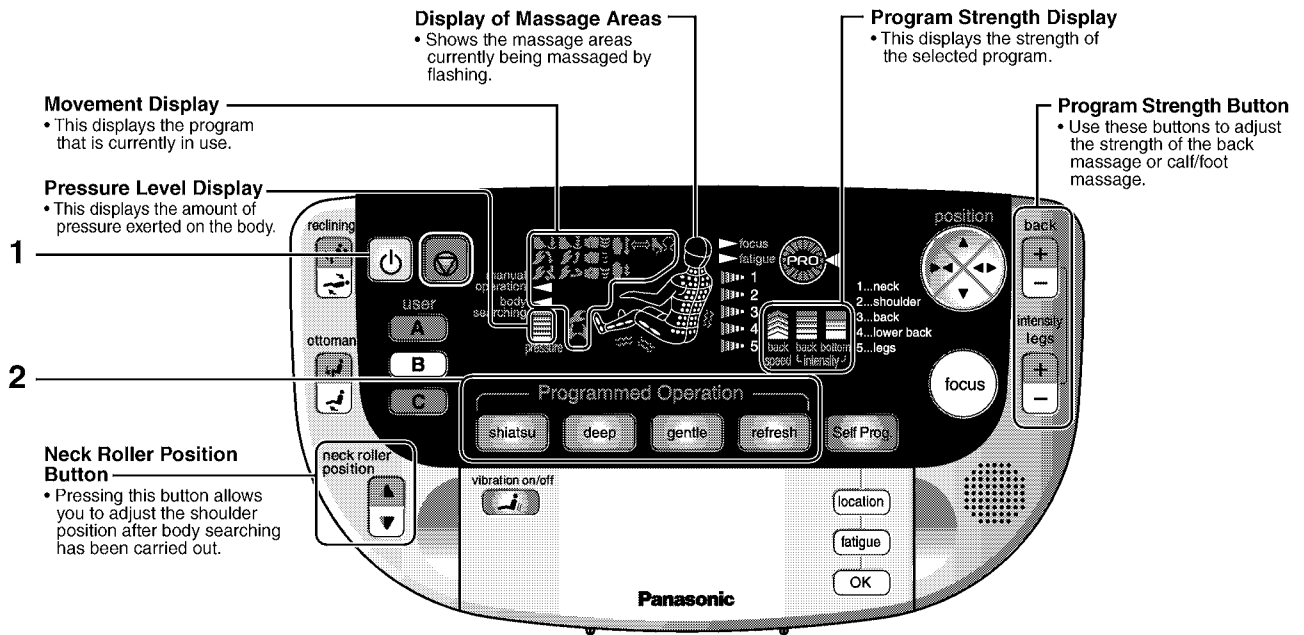





### 1. Press .

- The Programmed Operation buttons (four) and the Self Program buttons will start to flash.
- The massage heads will not start to move until you press one of the program buttons.

### 2. Select the program you want.

- Please press one of the flashing buttons.
- See Page 13 for details regarding the content of each of these Programmed Operation.
- It is possible to change programs during the massage by pressing one of the other program buttons.

- |                                                                                                                                                                                                                                                                                                      |                                                                                                                                                                                                                                                                                                                      |
|------------------------------------------------------------------------------------------------------------------------------------------------------------------------------------------------------------------------------------------------------------------------------------------------------|----------------------------------------------------------------------------------------------------------------------------------------------------------------------------------------------------------------------------------------------------------------------------------------------------------------------|
| <p> <b>shiatsu</b></p> <ul style="list-style-type: none"> <li>• This program uses mainly Shiatsu massage to provide a strong massage that is ideal for people who have extremely stiff shoulders, etc.</li> </ul> | <p> <b>gentle</b></p> <ul style="list-style-type: none"> <li>• This program uses a gentle massage to help soothe tired body with a gentler, longer Swedish style massage strokes.</li> </ul>                                      |
| <p> <b>deep</b></p> <ul style="list-style-type: none"> <li>• This program uses kneading massage to thoroughly relax stiff muscles in many areas. Still a strong massage.</li> </ul>                               | <p> <b>refresh</b></p> <ul style="list-style-type: none"> <li>• This is a more general program using a variety of massage movements to help refresh people when they're feeling tired. Mixes both Shiatsu and Swedish.</li> </ul> |

### 3. Sit as far back in the seat as possible with your head on the pillow (back cushion/backrest).

Press the program button you desire to start the massage. The seat will automatically recline to the massage position and body searching will commence.

- You will feel a light tapping sensation on your shoulders. Always check the shoulder position and when necessary adjust it manually with the neck roller position button.
- Body searching can be carried out for people with a height of 4.6 ft (140 cm) to 6.1 ft (185 cm).

After body searching has been completed the massage will commence.

- The air massage on the legs/calf will commence at the same time that body searching commences.
- You can freely adjust the angle of the backrest and legrest.
- Slide the legrest to adjust the position of your knees and calves. (See Page 14)

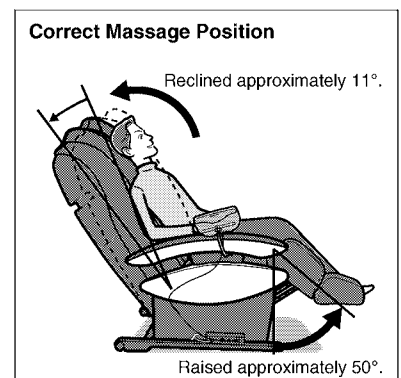

- If the massage lounge is reclined further than this angle then it will not automatically recline.



#### 4. After the Massage has been Completed the Unit will Automatically Stop.

After the designated program has been completed the massage lounger will automatically stop. (Approximately 15 minutes.)

##### Stopping the Massage during a Program

- Press  again.
- The legrest will automatically be lowered and the massage heads will return to the retracted position. After the massage heads have stopped moving the backrest will return to the original position.

##### Stopping the Massage Immediately

- Press  if you want to stop the massage immediately.
- All movement will immediately stop.
- Please press  twice in order to return the massage heads to the retracted position.
- \* After the program has been completed the voice navigation will provide information regarding user program functions and  will flash.

##### Adjusting the Strength of the Back Massage

Please press  to adjust massage strength.

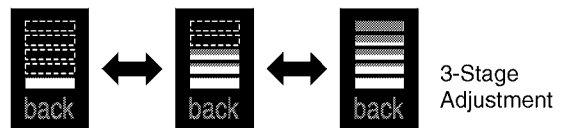

##### Adjusting the Strength of the Leg/Calf Massage

Please press  to adjust massage strength.

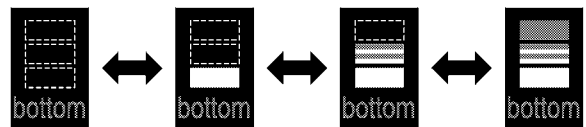

\* When the strength is set to 0 (i.e. no bars are lit on the display) the leg/calf air massage will stop and change to the back massage only.

##### Turning off Vibration

Please press  to stop the vibration in the desired area. Press it again to restart it. (EP3203 only.)



##### Body Searching — Adjusting Shoulder Position

The massage rollers will rise up the back until they reach the area behind the neck, after which they will descend to the level of the shoulders where soft tapping will be carried out for approximately 10 seconds.

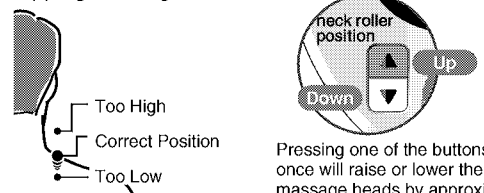

Use the Neck Roller Position Adjustment button to properly set the shoulder position while soft tapping is being carried out.



- When there is nobody sitting in the seat or when body searching has not been carried out successfully, “massage terminated” will be announced and the soft tapping will stop. If this happens then please sit as far back as possible with your head on the pillow (back cushion/backrest) and push  to carry out body searching again.
- When someone else wishes to use the massage lounger midway through a massage, please push  to stop the massage and start from the beginning again as the shoulder position will vary from person to person.

## Additional Information

### Display of Massage Areas

Sometimes the massage areas displayed on the control panel will be different from what you are actually experiencing.

\* Due to limitations in the size of the display, the massage areas displayed on the control panel are only a general indication of the area being massaged. This means that sometimes the areas that are actually being massaged are different from those shown on the display. Areas of massage displayed may change depending on changes to massage intensity or position of massage heads.

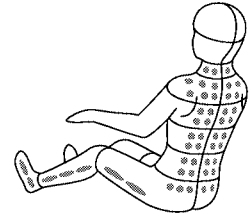

### Pressure Level Display

The pressure being applied to the body is shown on the display.

- The actual pressure experienced may vary from the level indicated on the display.
- Depending on the seatback fabric, the pressure level indicated may change even when nobody is sitting in the seat.

### Pressure Feedback Function

The strength of the massage (pressure level) is automatically adjusted if it is too much or too little.

- The standard body pressure level varies according to the strength of the program selected.



### Programmed Operation

- Please see Page 25 for details regard the lower body massage.
- The movements below are shown in simplified form for the sake of illustration.

### Shiatsu Program

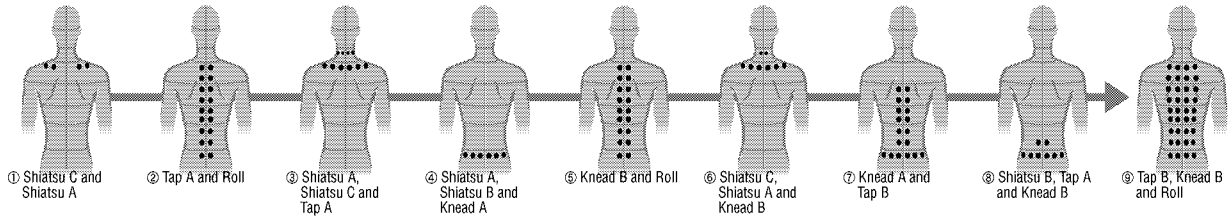

### Deep Program

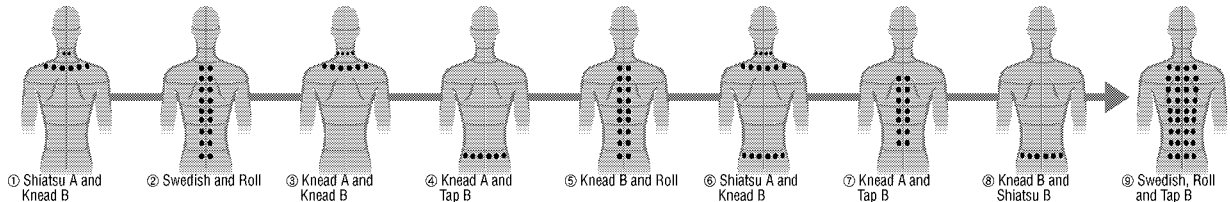

### Gentle Program

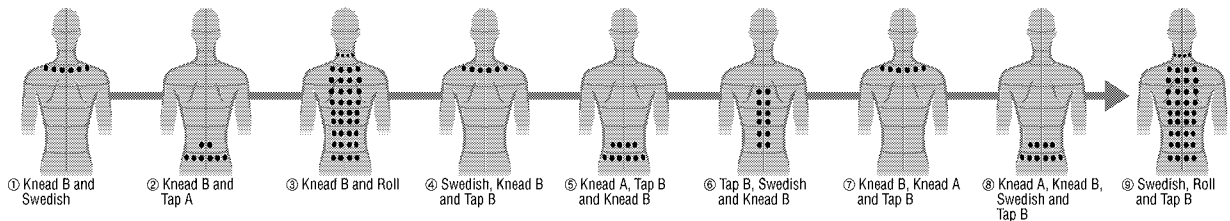

### Refresh Program

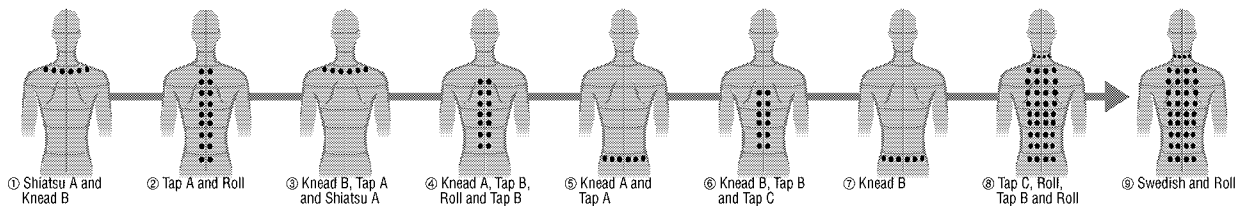

## ADJUSTING THE SEAT

### Reclining the Massage Lounger

#### 1. Hold down until you reach the desired angle.

- Holding the button down will recline the seat and raise the legrest.
- Shortly after the backrest starts to recline the legrest will be raised.
- When both the backrest and legrest have been raised or lowered as far as possible you will hear a “beep-beep-beep” sound.
- The backrest and legrest may reach their limits at different times.
- Adjust the position of the back cushion so that it does not come into contact with your elbows.

#### 2. Release when you have reached the desired position.

- If you have reclined the back more than you want, press  to raise it again.
- Do not recline the back too far when first using the unit as you may find the massage to be too strong.

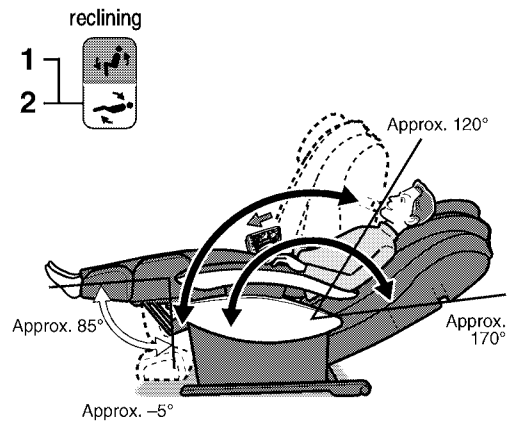

#### Raising the Backrest and Legrest

Hold down  to raise the backrest and legrest

- When both the backrest and legrest have been raised as far as possible you will hear a “beep-beep-beep” sound.

### Raising and Lowering Only the Legrest

#### Raising the Legrest

Hold down  to raise the legrest.

- When the legrest has been raised as far as possible you will hear a “beep-beep-beep” sound.

#### Lowering the Legrest

Hold down  to lower the legrest.

- When the legrest has been lowered as far as possible you will hear a “beep-beep-beep” sound.
- Ensure that the legrest slide has been fully retracted before lowering the legrest otherwise it will hit the floor (see below).

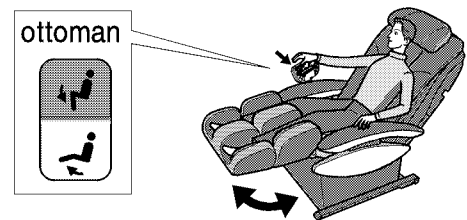

### Extending the Legrest

#### 1. Slide the legrest out to the desired position by pulling the legrest slide lever.



When you wish to retract the legrest, pull the legrest slide lever to release the legrest. Raise your legs slightly to allow the springs to retract the legrest.

#### 2. Release the legrest lever.

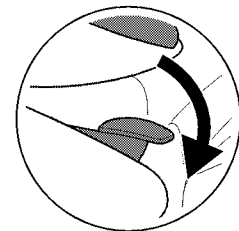

Once you have released the legrest slide lever the legrest will click into place and lock.



## WHEN YOU WANT TO CREATE YOUR OWN MESSAGE PROGRAM (SELF PROG.)

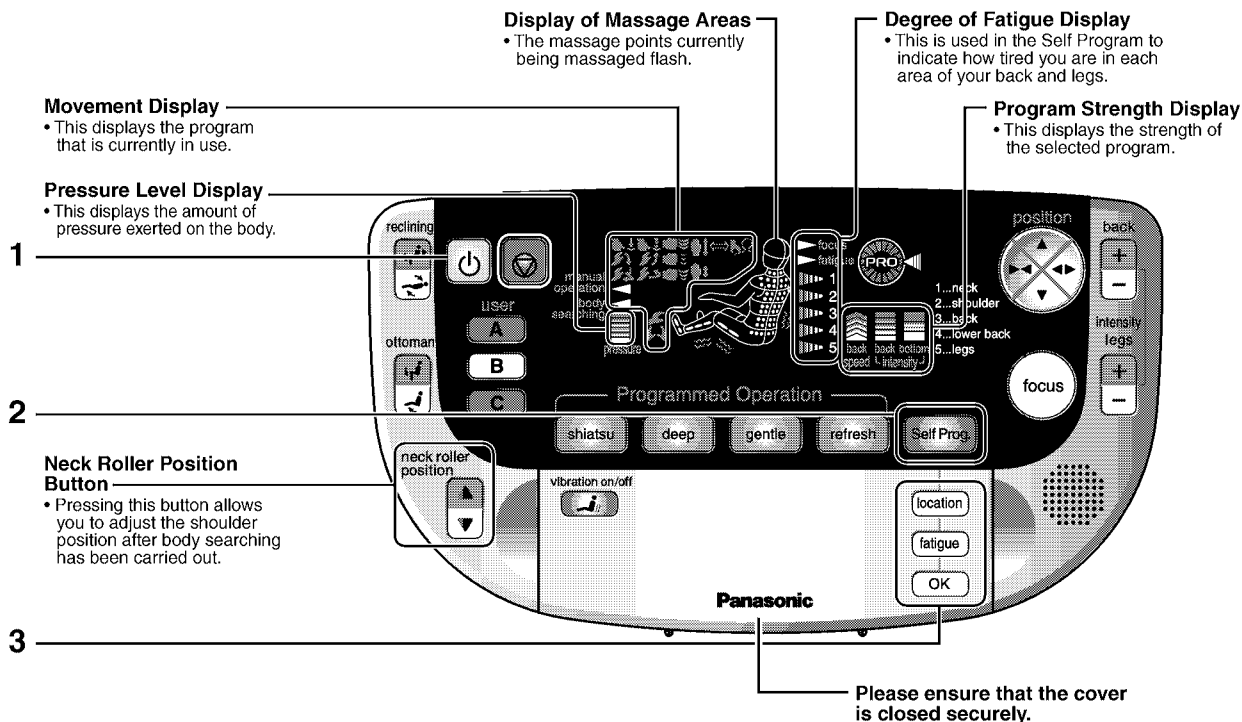

### 1. Press .

- Programmed Operation buttons (four) and the Self Program buttons will start to flash.

### 2. Press .

- The Degree of Fatigue indicators on the display will all start to flash on the neck area.
- The message heads will not start to move until you press .
- \* It is not possible to use the Self Program if the cover of the control panel is not completely closed.

### 3. Select the degree of Fatigue.

- (1) Press  to select the desired area of the body. The button will toggle down each time you press it.

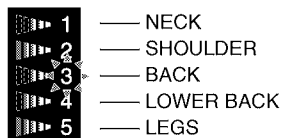

- The area of the body selected will start to flash.

- (2) Press  to select the degree of fatigue.

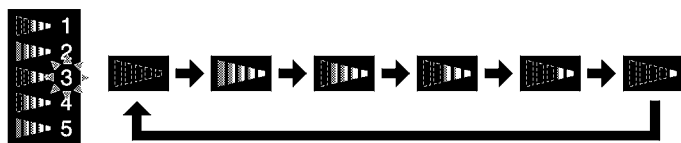

The degree of fatigue will decrease as you continue to press the button.  
After reaching the minimum setting, if you press the button again it will return to the maximum setting.  
The greater your selection, the more time and movement will be spent on that area. (See Page 18 for examples.)

- (3) Press  after you have finished inputting settings for the various parts of the body.

The message lounge will automatically create the message program best suited to the information you have input.  
Your selections will not be recorded until you have pressed .

#### 4. Sit back in the seat as far as possible with your head on the pillow (back cushion, backrest).

After pressing  the seat will automatically recline to the massage position and body searching will commence.

- You will feel a light tapping sensation on your shoulders. Always check the shoulder position and when necessary adjust it manually.

After body searching has been completed the massage will begin.

- The air massage on the lower body will commence at the same time that body searching commences. (If the legs has not been selected then the air massage will not commence.)
- You can freely adjust the angle of the backrest and legrest.
- Slide the legrest to adjust the position of your knees and calves. (See extending the legrest on Page 14.)

#### Self Program Example

“My shoulders and lower back are a bit sore today so I think I’ll focus on those areas.”

(1) I just want a light massage on my neck so I’ll set this at 1.

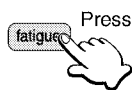

Degree of Fatigue



1

(2) My shoulders are really stiff so I’ll set this at 5.

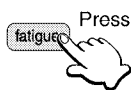

5

(3) My back’s fine so I’ll set this at 0.

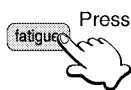

0

(4) My lower back feels pretty stiff so I’ll set this at 4.

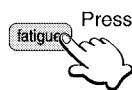

4

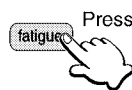

(5) I just want a light massage on my legs so I’ll set this at 1.



1

#### 5. After the massage has been completed the unit will automatically stop.

After the designated program has been completed the unit will automatically stop. The usual program takes about 15 minutes.

- If you want to stop the massage during a program press . Press  if you want to stop the massage immediately.
- \* After the program has been completed the voice navigation will provide information regarding user program functions and  will flash.

## Changing the Degree of Fatigue During the Program

- After pressing the button corresponding to the area you want to change and making any changes, press **OK**.
- You can change the program even during mid-program by following the procedures on Pages 15 and 16.

(1) Press **location** to select the area you want to change.





(2) Press **fatigue** to input the degree of fatigue.



(3) Press **OK** after you have finished making the desired changes.

### Additional Information

The message will be carried out in descending order from the greatest degree of fatigue.

- If the degree of fatigue selected is the same, the message will be carried out in the following order. Neck -> Shoulders -> Back -> Lower Back.
- If the degree of fatigue selected for any particular area is , then no message will be carried out in that area and the message heads may merely pass over that area on the way to the next selected area.
- If the degree of fatigue selected for the Neck to the Lower Back is , no upper body message will be carried out.
- If the degree of fatigue selected for the Legs is , no air message will be carried out.

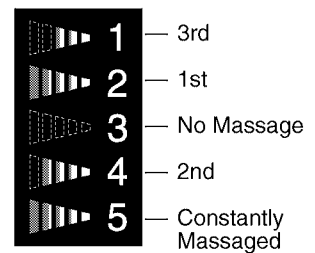

### Degree of Fatigue Settings are NOT Massage Strength Settings

- The movement and duration of the message is determined by the unit based on the degree of fatigue selected.
- Use the Strength buttons to adjust the strength of the message.
- Please note that in the Self Program message strength for the legs cannot be set to 0.
- The focus button cannot be used in Self Program mode.

## Additional Information

### Details regarding Self Program

- A simple explanation of the movements is provided below.

#### Stiff Neck/Fatigue

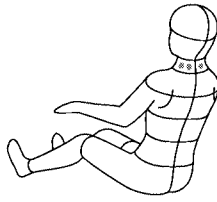

Degree of Fatigue



After using Knead B to relax the area surrounding the neck, Knead C and Tap A are used to massage areas of more severe stiffness.

After using Knead B to relax the area surrounding the neck, Tap A and Knead B are used to relax the muscles.

After using Knead B to relax the area surrounding the neck, Tap B and Knead C are mainly used to finish off with.

Tap B and Knead B are used to relax the area surrounding the neck.

Tap B is mainly used to relax the area surrounding the neck.

#### Stiff Shoulders/Fatigue

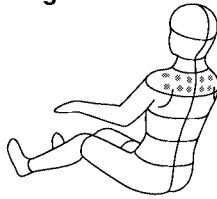

Degree of Fatigue



After using Shiatsu C, Tap A and Shiatsu A to relax the shoulders, a kneading massage is used along the shoulder blades.

After using mainly Shiatsu C and Shiatsu A to relax the shoulders, Knead C and Knead A are used on the area surrounding the shoulders.

After using mainly Tap B and Tap A to relax the shoulders, Shiatsu A and Knead B are used to finish off the area surrounding the shoulders.

Mainly kneading and Tap B are used to thoroughly relax the area surrounding the shoulders.

Mainly Tap B is used to gently relax the area surrounding the shoulders.

#### Back Muscle Fatigue

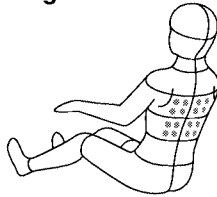

Degree of Fatigue



After using Knead B to relax the back muscles, Shiatsu B is then used to stretch the back muscles after which Knead A, Knead B and Knead C are used to relax the back muscles.

After using Knead B to relax the back muscles, Shiatsu B is then used to stretch the back muscles after which Knead A and Knead B are used to relax the back muscles.

Knead B and Knead A are used along the back muscles to relax them.

After using Tap B to relax the back muscles, Knead B and Knead A are used to relax them.

Mainly Tap B and Swedish are used to thoroughly relax the back muscles.

#### Lower Back Fatigue

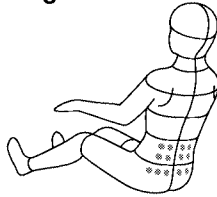

Degree of Fatigue



Knead B, Shiatsu B and Tap A are used to thoroughly relax the lower back muscles.

Knead B, Shiatsu B and Knead A are used to thoroughly relax the lower back muscles.

In addition to Knead B and Swedish, Tap C is used to relax the lower back muscles.

After using Tap B, Knead B and Tap B are used to relax the muscles.

Mainly Tap B and Swedish are used to thoroughly relax the muscles.

#### Legs/Soles of the Feet/Seat

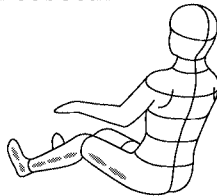

Degree of Fatigue



The selected area is repeatedly grasped and then squeezed. (See Page 26 for explanation of "grasp" and "squeeze" massage.)

After the selected area has been repeatedly grasped it is then repeatedly squeezed.

After the selected area has been relaxed using grasping and squeezing it is then finished off with a rubbing movement.

After the selected area has been slightly relaxed using grasping and squeezing a rubbing movement is used.

A rubbing movement is used to gently relax the selected area.

## WHEN YOU WANT MORE CONTROL OVER INDIVIDUAL MESSAGE SETTINGS. (USER ADJUSTMENT FUNCTIONS)

Using the User Memory Buttons allow you to customize the back massage. The more you use these functions the more you'll customize it to provide just what it is you like.

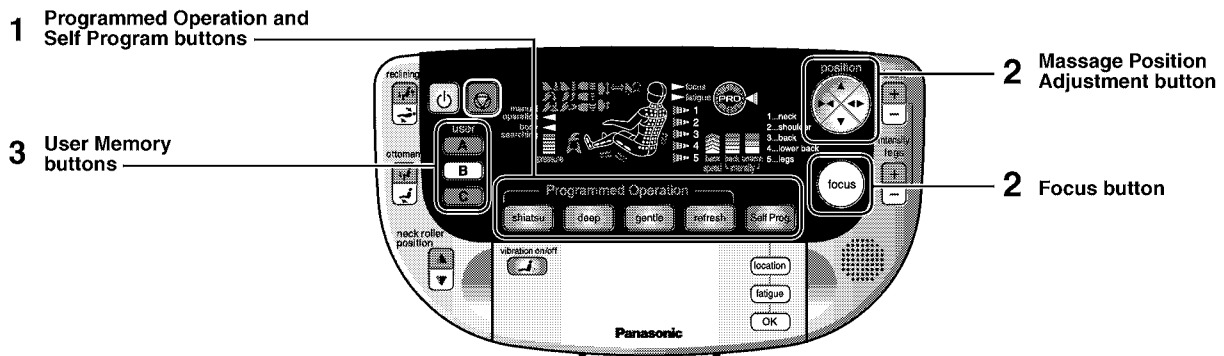





## When you Want More Control over Individual Massage Settings

1. Select and start the program (Programmed Operation and Self Program) you desire by following the procedures shown on Pages 11~18.
2. After the massage starts, adjust the program to your individual needs.

Spend more time on the location and type of message you like with the focus button.

Press  to increase the time spent on a particular location and type of message.





- During the program when the massage feels particularly good, press  to concentrate on that particular massage action.
-  will flash and the unit will increase the amount of time spent on that particular type of message.
- That particular kind of message action will be repeated once more.
- The location and the type of message will be recorded and the program will be changed to emphasize this area and type of message during the overall program.
- The focus function cannot be used in the Self Program.
- The focus function cannot be used when ,  or  are displayed.

### Fine Tuning Message Location.

Press  to fine tune the message location.

- Press this button to make minor adjustments to the location and lateral movement of the message heads during a program.
-  will start flashing.
- The message heads will move in accordance with the buttons you press.
- The location to which you have moved the message heads will be recorded and the program will be changed to move to this location whenever the program is selected.
- If you press the button and hear “peep-peep-peep”, this means that the message heads cannot be moved in the direction you have selected.

## 3. Recording the adjustments you have made.

- (1) After the program has finished, or when you have pressed , after the message heads have moved back to the retracted position  will start flashing after 20 seconds.
- (2) Select and press the User Memory Button you want to record this program in. (Press one of the buttons while  are flashing. They will flash for approximately 15 seconds.)
- (3) The button you selected and pressed will then continue to flash,  will flash and then the message will be completed.

### Recording over existing programs.

- If you try and record over an existing program then the button you have pressed will flash quickly.
- Press the same button again to erase the existing information and record the new information.
- If you do not want to erase the information, select and press another of the User Memory Buttons.

- If you decide that you do not want to record the information, press  without pressing any of the User Program buttons to cancel.
- While the information is being saved, none of the other buttons apart from the reclining and legrest button can be used.

## When you Want More Control over Individual Message Settings

1. Press .

2. Select and press the User Memory Button you require.

(You can actually press one of the User Program buttons without pressing .)



3. Select and press the program you desire. (i.e., shiatsu, deep, gentle, refresh, Self Prog.)

The specific treatment areas you recorded are displayed.

- The massage lounger will carry out body searching to check whether or not someone with the same physical characteristics is using the unit. (Nothing will be displayed and no sounds will be emitted during this period.) If the physical characteristics are the same as those recorded the previous time then the massage will start immediately. If, however, the physical characteristics are determined to be different then body searching will be carried out in the normal way before the massage begins.

### Creating a Customized Program

After following the procedures outlined on this page and the previous page, after the program has finished and while the button is still flashing press the same User Memory Button. You must press A or B or C to record any changes made.

### Erasing Recorded Data

- It is possible to restore the factory default settings.  
(It is not possible to return to the previously recorded User Program setting.)

(1) Press .

(2) Select and press the button with the information you want to erase.

- The button will stop flashing and the Programmed Operation buttons will start flashing.



(3) Hold the same button down (for at least 3 seconds) until , ,  and  stop flashing.

- The button selected will start to flash (for approximately 15 seconds).

(4) Press the same button again while it is flashing.

- The data recorded will be erased and the button will stop flashing.

## Additional Information

### Detailed Information regarding User Adjustment Functions

#### (1) What happens when I press ?

- The program will be changed so that the overall amount of time spent on that particular area during the program is increased.
- The massage action at the time when the button was pressed will first be repeated.
- The massage action at the time when the button was pressed will be increased in that area when that same massage action is carried out within the massage program.
- The overall time of the massage (approximately 15 minutes) will not be increased.
- This function cannot be used in the Self Program.

#### (2) What happens when I press ?

- The point where the massage is currently being carried out will be changed slightly.
- This is to ensure that the correct acupressure points can be reached on people with different physical characteristics.
- The button can be pushed once in each direction. This moves the massage heads approximately 11/16" (1.8 cm) up or down and approximately 1/4" (0.6 cm) left or right from the center of the pre-programmed acupressure point.
- The new point will be recorded and whenever that point is massaged during a program the massage heads will automatically move there.
- The new point is used in all programs.

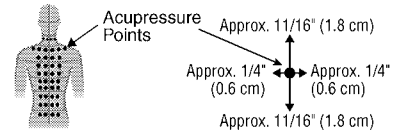

(The information recorded in each User Memory Button is independent of other User Memory Buttons.)

### Message Point Priority Display

When  is pressed or adjustments are made to the user data the results are shown in the Message Point Priority Display.



- The amount of time that will be spent on each point during the next massage is displayed.
- The higher the level, the longer the amount of time that will be spent on that point.
- The number of levels is an indication only and is not necessarily an exact indicator of the proportion of time that will be spent on each point.

### Advanced Use of the User Program Function

- Programmed Operations were created by professional massage therapists in accordance with the aim of each program. While based on these programs, the User Adjustment Functions allow users to modify the massage parameters. Therefore, it is not possible to focus on one particular area using this function (e.g. the shoulders) during a single massage. If you want to focus on one particular area then please use the Self Program or the Manual Operation.

### What Kind of Data Can Be Recorded?

#### Recordable Data

- The five Programmed Operations can be recorded in each of the User Adjustment Functions buttons. (The massage actions of Programmed Operations. The data from the previous Self Program.)
- Data regarding physical characteristics. (When the User Adjustment Functions button is pressed and the massage begins, body searching is carried out in accordance with this data and if that data matches then the massage begins. If it does not match then body searching is carried out again.)

#### The following are not recorded as part of the User Adjustment Functions:

- Data regarding Manual Operations.
- Massage lounge position (reclining angle and legrest angle).
- Data regarding the leg/calf massage.
- When Manual Operation has been selected during a Programmed Operation.
- Massage strength settings in the Programmed Operations.
- When the massage has been stopped by pressing  and the massage terminated.

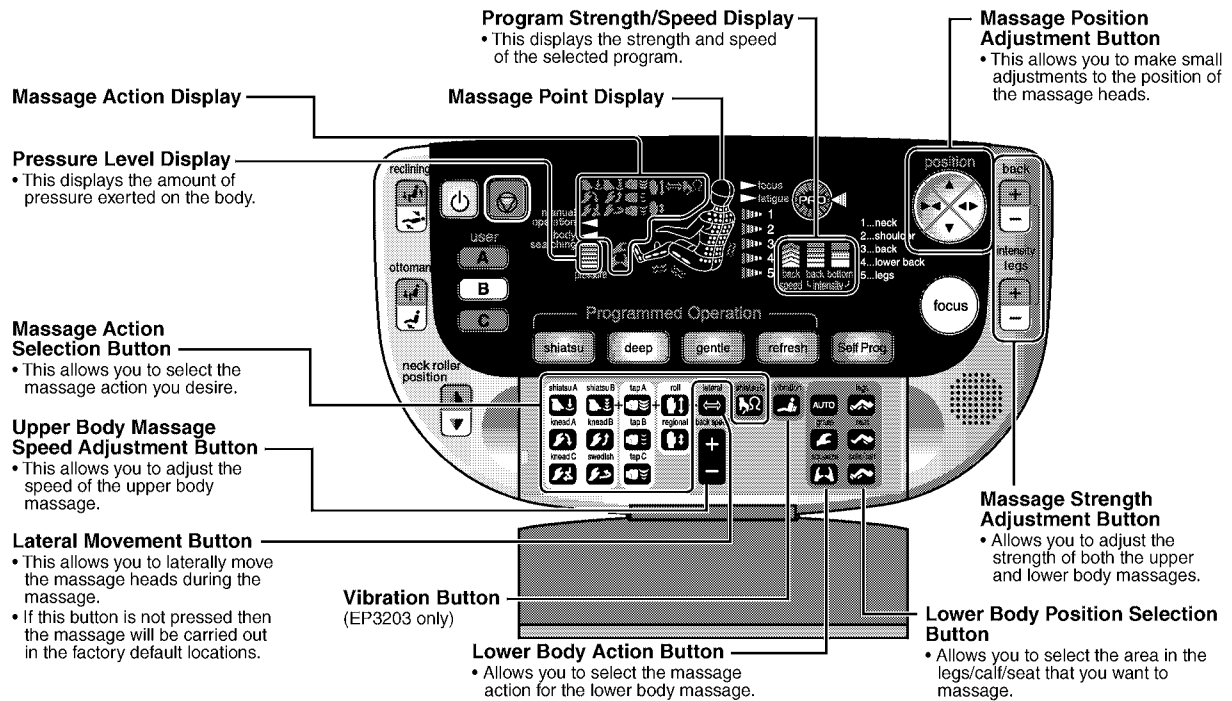

# WHEN YOU WANT TO CONTROL EVERYTHING YOURSELF. (MANUAL OPERATION)



## Upper Body Massage

1. Press .
2. Open the cover.
3. Select the massage action you desire and press the appropriate button.

Sit as far back in the seat as possible with your head on the pillow (back cushion/backrest).

- After pressing    body searching will be carried out in order to verify the shoulder position before the massage begins. (The shoulder position can also be adjusted.)
- The icons of the massage actions selected are shown on the display.
- You will feel a light tapping sensation on your shoulders. Always check the shoulder position and when necessary adjust it manually.

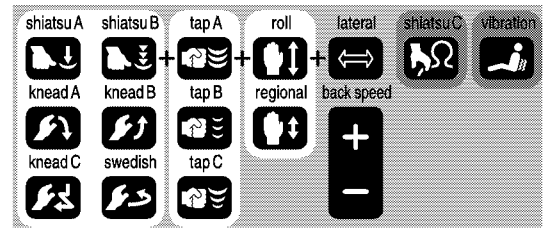
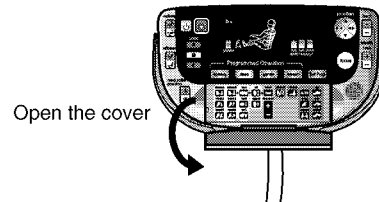

### You can Combine Multiple Massage Actions

- Press the buttons of the massage actions you require.

(Example)

Press the following buttons if you want to combine Shiatsu A, Tap A and Roll

- (1) Press . (2) Press . (3) Press .

\* The order in which the buttons is pressed does not matter.



- The selected massage actions are shown in the display.

- It is not possible to combine the massage actions within each of the groups shown in the diagram. e.g. It is not possible to combine Shiatsu A, Swedish, Tap A and Tap B, etc.

### Stopping a particular Massage Action

- To remove a massage action press the button corresponding to that action again. These switches are on/off toggles.

(Example)

If you want to remove Roll from the selection shown above then press .



- Roll has been removed from the massage action shown in the display.



## 4. When you want to customize your massage even more.

You can adjust the height and lateral movement of the massage heads, as well as the speed and strength of the massage.

### Adjusting Message Position



Press

- Press the button as many times as you like in any direction to move the massage heads to the position you require.
- Each time you press the button the massage heads move approximately 1 1/16" (1.8 cm) up or down and approximately 1/4" (0.6 cm) left or right.
- If you hold the up or down button down the massage heads will continue to move until you release the button.
- When the massage heads have been moved as far as possible you will hear a "peep-peep-peep" sound.
- In some places the strength of the massage will be automatically reduced.
- The approximate position of the massage will be shown on the display.
- In some cases the massage action will not immediately change even though the massage action button is pressed.

### Adjusting Message Speed



Press

- You can press the button as many times as you like to increase or decrease the speed of the massage.
- When the speed of the massage has been increased or decreased as much as possible you will hear a "beep-beep-beep" sound.
- It is not possible to adjust Shiatsu C.
- The speed of the massage is shown on the Massage Action Display in five stages.

### Adjusting Message Strength

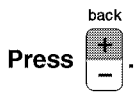

Press

- You can press the button as many times as you like to increase or decrease the strength of the massage.
- When the strength of the massage has been increased or decreased as much as possible you will hear a "beep-beep-beep" sound.
- In some places the strength of the massage will not be able to reach the maximum level of 5.
- The strength of the massage is shown on the Massage Action Display in five stages.
- Shiatsu C can be adjusted in five stages.
- In some cases the massage action will not immediately change even though the massage action button is pressed.

### Adjusting Lateral Movement



Press

- Press this button to increase the width of the massage in the location the massage heads were in when you pressed the button.
- ⇔ will be shown on the display.
- In some places the strength of the massage will be automatically reduced.
- Press the button again to revert to normal massage action.

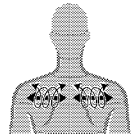

## 5. After the massage has been completed the unit will automatically stop.

- The unit will automatically stop approximately 15 minutes after the massage begins.
- If you want to continue using the massage lounge then we recommend that you wait at least 10 minutes in between each massage.
- If you want to stop the massage during a program press . Press if you want to stop the massage immediately.
- \* When stopping the massage when using Shiatsu C or Roll, the voice navigation will provide an explanation of the User Program function and will flash. In this case, if you press one of the User Memory Buttons only body searching data will be saved. (i.e. Details regarding the Manual Operation will not be saved.)

### Massage Actions (Upper Body)

shiatsu A



**Shiatsu:** This feels as though the thumbs of both hands are being used to work on the acupressure points. The initial strong push is followed by a short pause to give the impression of a professional shiatsu massage therapist.

shiatsu B



**3-Stage Shiatsu:** This massage features three increasingly strong pushes.

knead A



**Pressing:** This massage presses stiff muscles toward the outside and is effective on areas around the shoulder blades on the outer shoulders as well as the lower back.

knead B



**Kneading:** With this massage, a strong push is followed by a quick release in a rhythm that is designed to relax stiff muscles. It is ideal for loosening stiff muscles in the neck and beside the spine.

knead C



**Deep Kneading:** With this massage the massage heads work slowly over the acupressure points in a deep kneading motion.

swedish



**Wide Kneading:** This motion is like the palms of both hands being used to press and rub over a wide area from both sides of the body. This type of massage is ideal for someone wanting a broad swedish style massage on the back or lower back.

tap A



**Tapping:** This motion is like a fist used in a rhythmic pattern to provide a solid tapping that is designed to eliminate stubborn stiffness and tiredness.

tap B



**Soft Tapping:** With this massage soft tapping is carried out in a rhythmic pattern alternately to the left and right.

tap C



**Rhythmic Tapping:** With this massage slow tapping is alternated with light tapping to relax stiff muscles.

roll



**Rolling:** The massage heads become rollers that roll over the back up and down from the neck to the lower back to stretch the back muscles and relieve tension.

regional



**Regional Rolling:** The massage heads become rollers that roll over the back muscles, but this time in a specified 4 in. location.

shiatsu C



**Pressing:** With this massage the shoulder muscles are pressed down from directly above to bring relief to stiff muscles.

vibration



**Vibration:** The high frequency vibration action helps your tense body to relax. This is ideal when used together with rolling, etc. for a full body massage. (EP3203 only)

## Additional Information

### How to Get the Most Out of Your Massage Lounger

- (1) Start with a rolling massage only to allow your body to get used to the massage lounger. This stretches out your spine and relieves pressure from your cervical disks.
- (2) Next use a kneading or tapping massage in areas surrounding stiff muscles.
- (3) To finish off with use a rolling massage again to stretch your spine again.

### Example of a Localized Massage

#### Neck and Shoulders

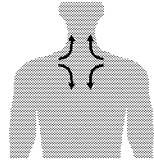

Use Knead B on the neck and Knead A, Shiatsu C and Shiatsu A on the shoulders.

#### Back

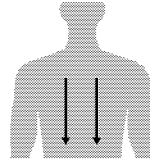

Use Swedish, Knead C and Soft Shiatsu up and down the back.

#### Lower Back

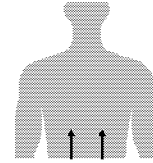

Use Swedish and Shiatsu B from the bottom to the top.

### Adjusting Massage Strength

- For safety reasons there are areas where it is not possible to select a massage strength of 5.
-  is pressed when massage strength has been set to 4 or 5, massage strength will automatically be set to 3 or 4 depending on the type of massage before lateral massage is carried out.
- When using Roll independently or in combination with other kinds of massage, the maximum massage strength setting is 3.

Points where massage can be carried out at the maximum strength of 5.



Points where massage can only be carried out at a maximum strength of 4.



Points where rolling massage can be carried out up and down the back.

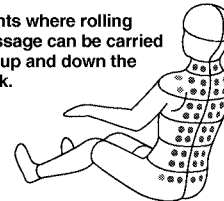

When the strength of the massage has reached 4 you will hear a "peep-peep-peep" sound.

### Rolling Massage

- When a massage is being carried out over a wide area, if Roll is selected, then the width of the massage will automatically be reduced before the Roll massage begins.

### Upper Body Massage Adjustment

The scope of the massage rollers depending on the type of massage selected is shown below.

#### Rolling Massage

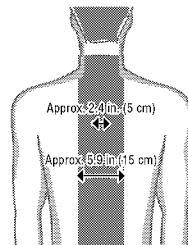

#### Other Massage

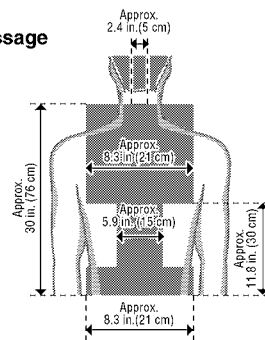

## Leg/Calf/Seat Massage

### Preparation

**Adjust the angle of the legrest and slide before starting a massage.**

- It is also possible to adjust the legrest and slide during a massage.

Air will be released while you are pressing  .  
Please change the position of your legs while air is being released.

When you want to massage the soles of your feet and your calves.

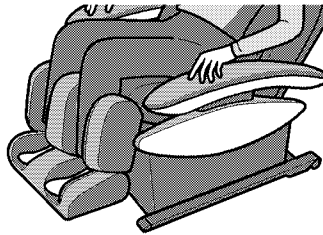

When you want to massage your legs from your ankles to your calves.

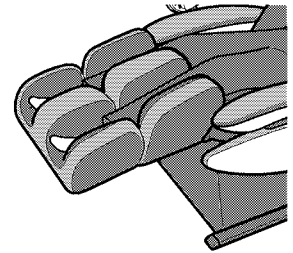

1. Press  .

2. Open the cover.

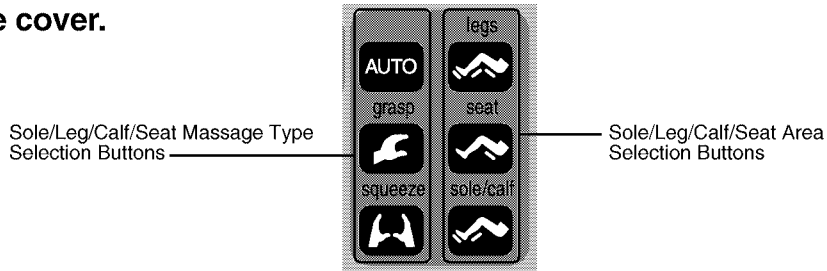

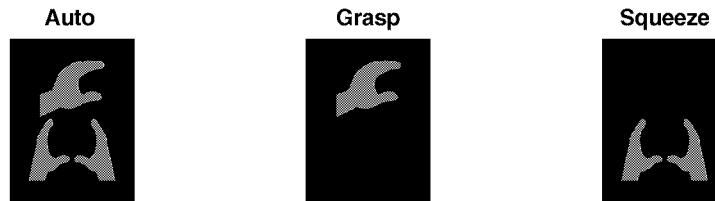

3. Select the area and massage type you require.

- The areas and massage actions you have selected will be shown on the display. (See below.)



- If you press one of the Sole/Leg/Calf/Seat Area Selection Buttons first then the massage action will be set to Auto.
- If you press one of the Sole/Leg/Calf/Seat Massage Type Selection Buttons first then the entire lower body will be selected.
- You can change to a different massage or a different area during the massage. If you change the massage or area then the air will be completely released before the massage begins again.

**If you press one of the Sole/Leg/Calf/Seat Massage Type Selection Buttons while carrying out Sole/Leg/Calf/Seat massage at the same time as carrying out back massage, the air massage will be terminated and only the back massage will continue.**

- If you press one of the Sole/Leg/Calf/Seat Massage Type Selection Buttons while carrying out only a Sole/Leg/Calf/Seat massage, then the massage will not stop.  
To stop the massage please press  or  .



4. Adjusting Massage Strength.

- Massage strength can be adjusted in three stages.

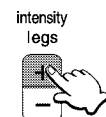
- Press  as many times as you like until you reach the required strength.
- When the strength of the massage has reached its limit you will hear a “beep-beep-beep” sound.
- The strength of the massage will be shown in Program Strength/Speed Display.



## 5. After the massage has been completed the unit will automatically stop.

- The unit will automatically stop approximately 15 minutes after the massage begins.
- It will take a number of seconds for the air to be completely released. (After pressing  you will hear air being released.)
- Press  if you want to stop the massage during a program. Press  if you want to stop the massage immediately.

### Massage Actions (Lower Body)

grasp



#### Grasp

- After applying pressure to the sides and backs of the legs, pressure is applied to each of the points on the calves and the muscles in the calves are relaxed in a rhythmic manner.
- This kind of massage is ideal after exercising when your muscles feel tired.

squeeze



#### Squeeze

- After applying pressure to the sides and backs of the legs, pressure is applied to the calves and they are slowly squeezed from the bottom up.
- This kind of massage is ideal for preventing swelling in the feet.



#### Auto

- In addition to the Grasp and Squeeze actions mentioned above, a diverse range of actions are used to promote the circulation of blood through the backs of the legs and feet that are prone to swelling, and to help refresh tired muscles.

Grasping



Squeezing

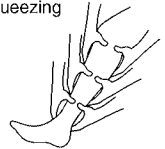



# AFTER COMPLETING THE MASSAGE

## RETURN THE SEAT TO THE ORIGINAL POSITION

1. Check that nothing is under the legrest and that air is being released.



2. Press  to return the backrest and legrest to their original positions.

- If you have slid the legrest out, ensure that it has been retracted before you press .

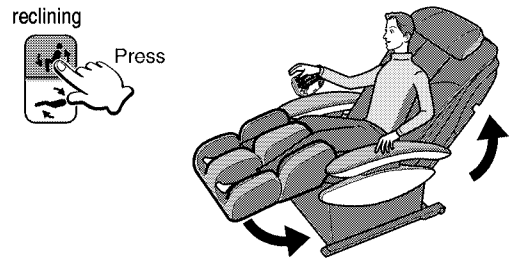

3. Replace the control panel in the control panel stand.

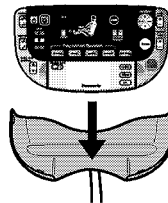

## DISCONNECT THE POWER

1. Turn the power supply switch to the off position.

2. Turn the lock switch to the lock position.

3. Unplug the power cord.

4. The unit should be switched to the off and the lock engaged when not using.

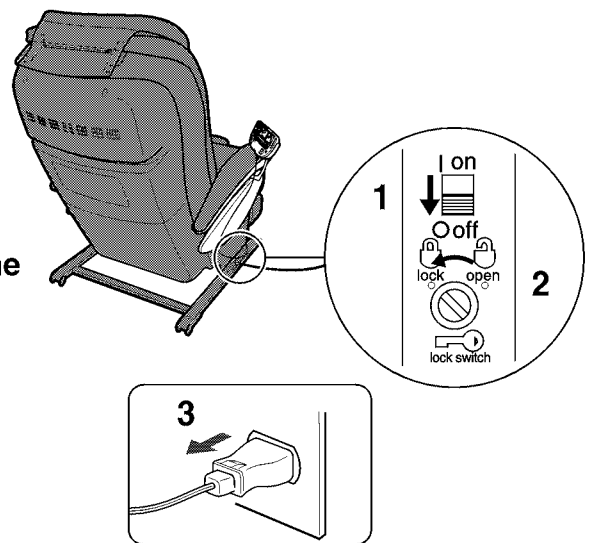

# CLEANING AND MAINTENANCE

## Moving the Unit

### Using the Wheels to Move the Unit

- Please lift up the front of the unit when moving it by holding the pipe section on either side of the legrest.
- \* Please be careful because the unit is heavy.
- It is easier to move the unit with the massage heads retracted and the backrest in the upright position.
- \* Place a mat on the floor and gently roll the unit over it to avoid damaging the floor.
- \* Do not move the unit while someone is seated on it.
- \* Please remove the control panel from the control panel stand.
- \* Please make sure the legrest slider is fully retracted when moving the unit.

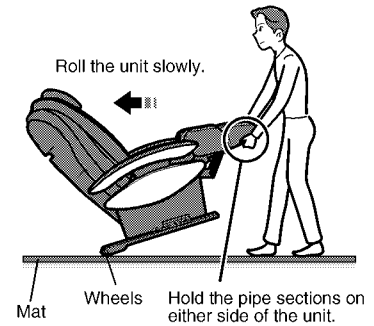

### Lifting the Unit

- Move the chair by having one person hold onto the pipe sections on either side of the legrest and another person use the handles on the back.
- \* Please hold the handles and legrest securely to avoid dropping the unit as it may damage your floor.
- \* Please make sure the legrest slider is fully retracted when moving the unit.

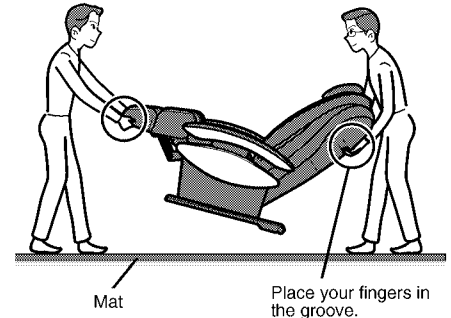

## CAUTION

- Do not move the unit while someone is seated on it.
- When moving the unit using the wheels, remove all obstacles from around it, make sure the backrest is in the upright position, lift it no higher than waist height (no higher than 32 in. (80 cm)) and roll it slowly.

Failure to do so may cause the unit to tip over, which may lead to damage or injury.

## Synthetic Leather on the Pillow, Back Cushion and Armrests

- Wipe these areas with a soft, dry cloth. (Do NOT use cloths containing any kind of chemical, etc.)
- If the synthetic leather is particularly dirty, soak a soft cloth in water or a 3~5% solution of mild detergent, wring it out thoroughly and tap the surface with it. Next, rinse the cloth in water, wring it out thoroughly and then wipe any remaining detergent from the surface, wipe the surfaces with a soft dry cloth and allow them to dry naturally. (Do NOT use a hair dryer to try to dry the surfaces more quickly.)

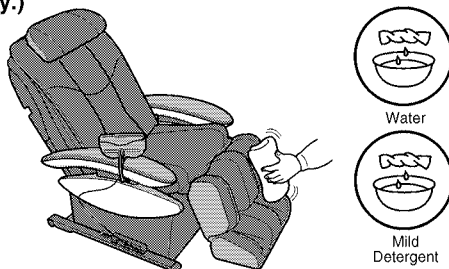

- Do not allow the unit to be in contact with these areas for extended periods of time as this may lead to discoloration.

## CAUTION

Always unplug the unit before cleaning it. Never touch a power plug with wet hands.

Failure to follow these instructions may lead to electrocution or burns.

## Pipe and Plastic Areas

- (1) Wipe the unit with a cloth that has been soaked in a mild detergent and then thoroughly wrung out.
- (2) Next wipe the unit with a cloth that has been moistened with just water and thoroughly wrung out.
  - \* Make sure you thoroughly wring out the cloth first when cleaning the control panel.
- (3) Allow the unit to dry naturally.
  - Please do NOT use thinners, benzene or alcohol.

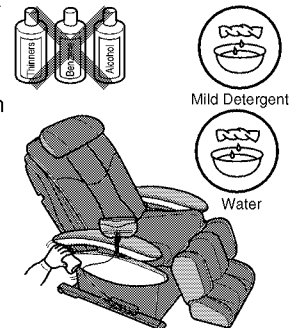

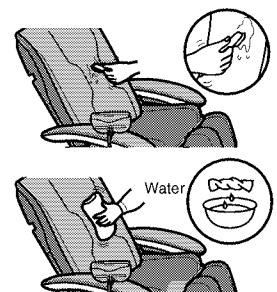

## Seat Fabric

- (1) Wipe the seat fabric with a cloth that has been soaked in a mild detergent and then thoroughly wrung out.
- (2) Use a mild detergent and brush on areas where the seat fabric has become particularly soiled. Be careful not to brush the fabric too much as you may damage it.
- (3) Next wipe the fabric with a cloth that has been moistened with just water and thoroughly wrung out.
- (4) Allow the fabric to dry naturally.



# TROUBLESHOOTING

PROBLEM	
Problem	Cause and Remedy
<p><b>Motor Noises</b></p> <ul style="list-style-type: none"> <li>• It sounds and feels like the massage heads are straining to get over wrinkles in the cloth.</li> <li>• The motor groans when it comes under load.</li> <li>• There is excessive noise during Tapping. (The noise is greater at the top of the massage lounger.)</li> <li>• There is a creaking noise when the massage heads are in operation.</li> <li>• There is a sound when the vibration action is selected. (EP3203 only.)</li> <li>• There is a rattling sound when the massage heads move up or down.</li> <li>• The belt can be heard rotating.</li> <li>• There is a rubbing sound produced by the massage heads rubbing on the seat fabric.</li> <li>• There is a noise when the backrest cushion moves over the armrest when the seat is reclining.</li> <li>• There is a noise when I sit down.</li> <li>• There is a strange sound when the massage heads move in and out.</li> <li>• When the power switch is turned on there is a humming sound.</li> <li>• Air massage-related sounds. There is a hissing sound of air escaping. There is a humming sound from the pump.</li> <li>• The legrest rattles.</li> </ul>	<p>▶ These sounds are perfectly normal and will not have any effect on the operation of the unit.</p>
<p><b>The massage heads stop during operation.</b></p>	<p>▶ <u>If excessive force is applied to the massage heads during operation, in the interests of safety the massage heads may stop moving.</u> If this occurs, raise your body slightly before restarting it. If all markings and buttons on the control panel start to flash, which is extremely unusual, turn off the power switch, wait for approximately 10 seconds and then turn the power switch on again.</p>
<p><b>In the Self Program the button does not flash even though it has been pushed</b> (i.e. it is not possible to select the Degree of Fatigue).</p>	<p>▶ The cover of the control panel has not been closed properly (i.e. it has to click into place). (See Page 15)</p>
<p><b>The massage heads do not come up to the shoulder or neck.</b></p>	<p>▶ The position of the massage heads is incorrect. (See Page 12)</p>
<p><b>The height of the left and right massage heads is different.</b></p>	<p>▶ An alternating tapping method is employed, which means that this phenomenon will naturally occur. There is nothing wrong with the unit.</p>
<p><b>The air in the seat is not being released.</b></p>	<p>▶ If the power cord is unplugged or there is a power cut while air massage is being carried out, the air will be trapped in the unit. The air will automatically be released when the power cord is plugged back in again (or when the power comes back on).</p>

Problem	Cause and Remedy
<p><b>It is not possible to recline the unit. The legrest cannot be raised or lowered.</b></p>	<p>▶ If the unit encounters an obstacle or if excessive force is exerted on it during operation, in the interests of safety the unit will come to a stop. If all markings and buttons on the control panel start to flash, which is extremely unusual, turn off the power switch, wait for approximately 10 seconds and then turn the power switch on again.</p>
<p><b>Reclining does not take place even though a massage is started in Programmed Operation. (The seat does not automatically recline.)</b></p>	<p>▶ In some cases the seat may not automatically recline depending on the position (angle) of the backrest or the legrest.</p>
<p><b>The backrest does not return to the upright position.</b></p>	<p>▶ The backrest will not return to the upright position if the timer is activated or the  button is pressed.</p>
<p><b>The legrest does not go down.</b></p>	<p>▶ The legrest will not go down properly if the legrest slide has been extended. Try again after retracting it.</p>
<p><b>The unit will not operate at all.</b></p> <ul style="list-style-type: none"> <li>• Upper body (neck to lower back) massage.</li> <li>• Lower body (calves to seat) massage.</li> </ul>	<p>▶</p> <ul style="list-style-type: none"> <li>• The power cord has been disconnected. (See Page 7)</li> <li>• The power switch on the unit has not been turned on. (See Page 7)</li> <li>• After pressing  button Programmed Operation button or the Manual Operation button has not been pushed. (See Pages 11, 15, 22)</li> </ul>
<p><b>The unit has been damaged.</b></p>	<p>▶ Stop using the unit immediately.</p>
<p><b>The power cord or power plug is abnormally hot.</b></p>	<p>▶ Stop using the unit immediately.</p>

For service information, call 1-800-338-0552 (USA only) to find out about the servicer in your area.



# SPECIFICATIONS

<b>Power Supply:</b>	AC120 V 60 Hz
<b>Power Consumption:</b>	260 W
<b>Upper Body Massage</b>	
Massage Area (Up-Down):	Approx. 30 in. (76 cm) (The massage heads move a total of approx. 64 cm)
Massage Area (Left-Right):	Distance between Massage Heads during Operation
	Neck, Shoulder, Lower Back: Approx. 2.0 – 8.3 in. (5 – 21 cm)
	Back: Approx. 2.0 – 5.9 in. (5 – 15 cm)
Massage Area (Forward-Back):	Approx. 3.9 in. (10 cm)
Up-Down Movement Speed:	Approx. 25 – 90 sec. return.
Massage Speed:	Knead A, B: Approx. 9 – 15 cycles/min.
	Tap: Approx. 200 – 700 sec. (one way)
Lateral/Vertical Travel:	Lateral Travel: Approx. 2.0 in. (5 cm) left-right auto return
	Vertical Travel (Long): Approx. 30 in. (76 cm) up-down auto return
	Vertical Travel (Short): Approx. 4 in. (10 cm) up-down auto return
Massage Width:	Rolling, Vertical Movement: Approx. 2.0 – 5.9 in. (5 – 15 cm)
	Other than the above: Same as massage area (left-right).
<b>Lower Body Massage</b>	
Air Pressure:	Strong: Approx. 22 kPa
	Medium: Approx. 16 kPa
	Weak: Approx. 10 kPa
<b>Reclining Angle:</b>	Backrest: Approx. 120° – 170°
	Legrest: Approx. -5° – 85°
<b>Automatic Shut-Off:</b>	Approx. 15 min. for both upper and lower body
<b>Dimensions:</b>	
When not reclined. (H × W × D)	45.3 × 30.3 × 49.2 in. (115 × 77 × 125 cm)
When reclined. (H × W × D)	28.3 × 30.3 × 72.8 in. (72 × 77 × 185 cm)
<b>Weight of Unit:</b>	Approx. 164 lbs (74 kg)
<b>Weight in Box:</b>	Approx. 195 lbs (88 kg)
<b>Maximum User Weight:</b>	264 lbs (120 kg)
<b>Minimum Distance from Wall:</b>	16 in. (40 cm)