

This Owner's Manual is provided and hosted by [Appliance Factory Parts](http://www.appliancefactoryparts.com).



PANASONIC NC-EM22P Owner's Manual

[Shop genuine replacement parts for PANASONIC
NC-EM22P](#)



[Find Your PANASONIC Small Appliance Parts - Select From 148 Models](#)

----- Manual continues below -----

Electric Thermo Pot Bouilloire
電子保温熱水瓶 電気ジャー

Operating Instructions Manuel d'utilisation 使用説明書 取扱説明書

NC-EM22P/NC-EM30P

Table of Contents

IMPORTANT SAFEGUARDS
Part Names and Handling Instructions
Overheating Protection
How to Use
Daily Maintenance
Cleaning with Citric Acid
Troubleshooting
Replacement of Parts
Specifications

Table des matières

PRÉCAUTIONS IMPORTANTES
Nomenclature et instructions de manipulation
Protection contre la surchauffe
Utilisation
Entretien quotidien
Nettoyage du réservoir intérieur avec de l'acide citrique
Guide de dépannage
Remplacement des pièces
Spécifications

Thank you for purchasing the electric thermo pot.
Please read these instructions carefully and
save this manual for future use.

Nous vous remercions d'avoir arrêté votre choix.
Avant d'utiliser l'appareil, il est recommandé de lire
et de le conserver pour consultation.

承蒙您購買NC-EM22P/NC-EM30P/NC-EM30P電氣
保溫熱水瓶。之後請妥善保存此說明書。

電氣保溫熱水瓶、NC-EM22P/NC-EM30P/NC-EM30P
の說明書をよくお読みの上、正しくお使いください。
この説明書をよくお読みの上、正しくお使いください。

**Panasonic Consumer Electronics Company,
Division of Matsushita Electric Corp of America.**
One Panasonic Way, Secaucus, New Jersey 07094
For assistance, please call 1-800-211PANA
or send e-mail to: consumerproducts@panasonic.com
or visit us at www.panasonic.com

Panasonic Canada Inc.
5770 Ambler Drive,
Mississauga, Ontario, L4W 2T3
<http://www.panasonic.ca>

© 2003 Matsushita Electric Industrial Co., Ltd.
Printed in Thailand Imprimé en Thaïlande

PZ05A4872
C1203T2104

IMPORTANT SAFEGUARDS

When using electrical appliances, basic safety precautions should always be followed, including the following:

1. **Read all instructions.**
2. **Do not touch hot surfaces, especially the steam vent. Use handles or knobs.**
3. **To protect against fire, electric shock and personal injury, do not immerse cord, plugs, or Thermo Pot in water or other liquid. Do not splash water or other liquid over them.**
 - Do not pour water directly from the tap.
 - Do not put the unit in a sink or allow it to get wet.
 - Do not turn the unit upside down when the bottom is wet.
4. **Close supervision is necessary when any appliance is used by or near children.**
 - Do not allow children and persons unfamiliar with the appliance to use it. Do not leave the unit within the reach of infants.
 - You must pay special attention to prevent infants from putting the body plug into their mouths.
5. **Unplug from outlet when not in use and before cleaning. Allow to cool before putting on or taking off parts, and before cleaning the appliance.**
 - When unplugging, pull by the power plug - not the cord.
6. **Do not operate any appliance with a damaged cord or plug or after the appliance malfunctions, or has been damaged in any manner. Return appliance to the nearest authorized service center for examination, repair or adjustment.**
 - Never disassemble, repair, or modify the unit.
 - If the supply cord is damaged, it must be replaced by a special cord available from the manufacturer or its service agent.
7. **The use of accessory attachments not recommended by the appliance manufacturer may result in fire, electric shock or personal injury.**
8. **Do not use outdoors.**
9. **Do not let cord hang over edge of table or counter, or touch hot surfaces.**
10. **Do not place on or near a hot gas or electric burner, or in a heated oven. Do not place on unstable surfaces or surfaces that can be affected by heat, or near walls or furniture.**
11. **Extreme caution must be used when moving an appliance containing hot liquids.**
 - When carrying the unit, do not touch the lid opening lever.
12. **Always attach plug to appliance first, then plug cord into the wall outlet.**
 - Make sure the power plug is correctly inserted in to the wall outlet when in use.
 - Do not connect or disconnect the power plug or the body plug with wet hands.
13. **Use a single outlet that matches the power rating of the unit.**
14. **Clean dust from the power plug or the body plug regularly.**
 - A build-up of dust on the plug will attract condensation, which could cause cable damage resulting in fire. Remove the plugs and clean them with a dry cloth.



Main unit

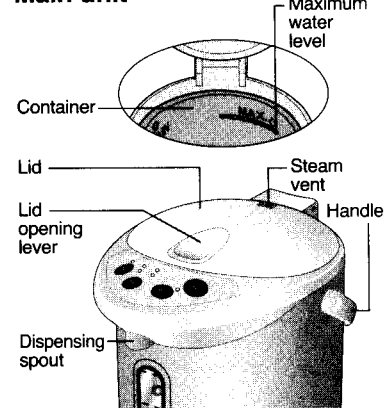

Power cord

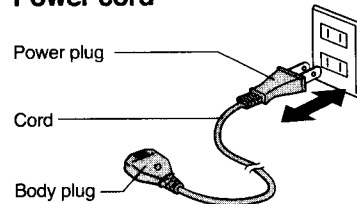

24. **Do not rotate the unit while dispensing.**
25. **Do not use appliance for other than intended use.**
 - Do not use to store ice. Condensation may cause electric shock and malfunction.
 - Do not heat tea bags, tea leaves or other items. Steam may spurt out and cause burns. The container may burn or corrode, and the appliance may be damaged.

SAVE THESE INSTRUCTIONS

Note:

- A. A short cord is provided to reduce the risk of tripping.
- B. Extension cords are available and should be used only if necessary.
- C. If extension cord is used,
 - 1) the marked electrical rating of the extension cord must be at least equal to the electrical rating of the appliance.
 - 2) the cord should be arranged so that it is not pulled across the tabletop where it can be pulled over.
- D. This appliance has a polarized plug. If the plug does not fit fully in the outlet, reverse the plug. Do not modify the plug in any way.

Part Names and Handling Instructions

Main Features

• **Keeps water warm economically**
The 6-hour timer and 185 keep-warm can reduce electricity costs. (See "For Economy Use" on P.12)

• **Keeps warm temperature selections includes 140 keep-warm.**
It is ideal for making baby formula.

• **Cleaning with citric acid regularly allows the product to function at its best.**
(See "Cleaning with Citric Acid" on P.14)

• **Be sure to let milk cool down and mix it with cool boiled water before giving it to a baby.**

(See "140 keep-warm function" on P.12)

Main unit

Dispensing spout

Water level float

It cannot be seen when water level is above the window rim.

Minimum water level mark

Add water before the minimum water level is reached.

Rotating base (360 degrees)

When rotating the pot, do not allow the cord to wind around the unit.

Steam vent

Lid

Handle

Leave the handle in place, when the unit is in use.

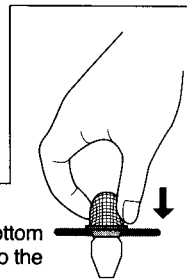

Mesh filter (Replaceable part)

It may have been come off from the bottom of the container. Push it completely into the correct position (See P.16)

Do not place the unit onto a vinyl table cloth or similar material.
(The odor of the vinyl or similar may be carried over into the water.)

Power cord

Power plug

Cord

Body plug

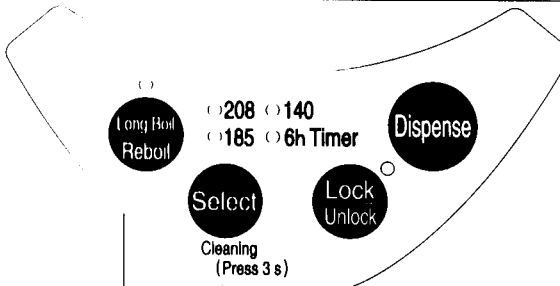
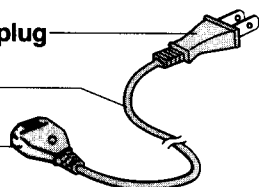

Operation Panel

If the protective film is still covering the surface of the operation panel, peel it off before using the operation panel.

How to Remove the Lid

1. Press the depression in the lid opening lever, and lift the lid.

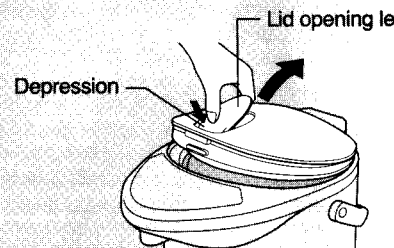

• **To close**
Press down on the lid until it clicks.

Overheating Protection

If an empty container is heated, the overheating protection (from being heated) will be activated. The protection that can occur due to overheating. This will...



How to cancel the display

Pour water into the container, and press the...

If an empty container is heated, an odor...
Please observe the following.
• Do not connect the power without pouring water.
• Do not boil water when less than the minimum water level.
• After water is added, do not leave the unit unattended.

Before you use this pot for the first time, boil water in it to clean the thermo pot container and (Boil some water, dispense about half the hot water and then empty the container.)

the sections through which the hot water is dispensed

1 Boiling water

- Pour in water with another container. Close the lid securely.
- Securely plug the body plug horizontally into the body.
- Plug into wall outlet.
- The "208" indicator light flashes, the "Long Boil/Reboil" indicator light is lit and water starts boiling.
- After the water has been boiled, the "Long Boil/Reboil" indicator light goes off. Then the "208" indicator light will be lit and the boiled water will be kept warm at approx. 208°F (98°C) automatically.

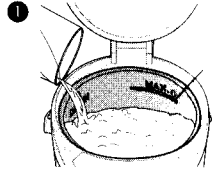

Maximum water level mark

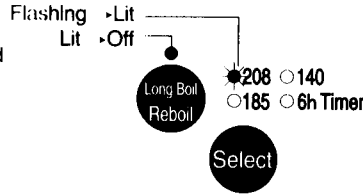
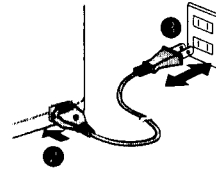

Time required to boil water

- NC-EM22P: approx. 20 min.
- NC-EM30P: approx. 27 min.
- NC-EM40P: approx. 35 min.
- (Amount of water : Maximum / Room temperature : 68°F (20°C))

How to reduce the chlorine in the water

- Press 'Long Boil/Reboil' key to make the indicator light flash. Extends the boiling time by about 6 minutes to reduce the chlorine in the water.
- Press 'Long Boil/Reboil' key again to boil.



2 Dispensing

- Press the 'Lock/Unlock' key to release lock. The indicator light beside the key will be lit.
- Press 'Dispense' key and dispense the hot water. The 'Dispense' key will be re-locked automatically in 10 seconds after dispensing hot water. (The "Unlock" indicator light will go off.)
 - To lock the key immediately after dispensing water, press the 'Lock/Unlock' key. (The "Unlock" indicator light will go off.)

Reboil

Press the 'Long Boil/Reboil' key to reboil water that is being kept warm. The "Long Boil/Reboil" indicator light will be lit. (The keep warm temperature setting is left unchanged.)

Time required for the reboil procedure :

- When keep warm is set at 208 keep-warm : 2-3 min.
- When keep warm is set at 185 keep-warm : 4-8 min.
- When keep warm is set at 140 keep-warm : 9-18 min.
- (Amount of water : Maximum / Room temperature : 68°F (20°C))

When the water runs low

Refill water before it becomes lower than the minimum water level mark.

When the unit is not used

Unplug, and remove the lid. Pour out any remaining hot water via the 'DRAIN' mark.

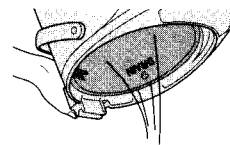

For Economy Use

When the unit will not be used for a short time, are sleeping or when you go out for the day, or keep-warm you can reduce the amount of

185 keep-warm function

Press the 'Select' key to select "185" keep-warm. The "185" indicator light will be lit.

The temperature of hot water will drop to approx.

Time required to reach approx. 185°F (85°C)

- NC-EM22P/NC-EM30P : Approx. 1 hour
- NC-EM40P : Approx. 2 hours

(Amount of water : Maximum / Room temperature)

6-hour timer

Press the 'Select' key to select the "6h Timer".

When the timer is started, the indicator light will

6 hours later, water starts boiling and timer in

While water is boiling, "Long Boil/Reboil" indi

and "185" indicator light will be flashing.

When the water is brought up to boiling temp

Reboil" indicator light will go off. The "185" ind

to steadily lit and water will be kept warm at a

Even if the keep-warm temperature setting was water will be kept warm at approx. 185°F (85°C)

140 keep-warm function

Press the 'Select' key to select "140" keep-w

The "140" indicator light will flash.

The temperature of hot water will drop to app

and the indicator light will change to steadily

Time required to reach approx. 140°F (60°C)

- NC-EM22P/NC-EM30P : Approx. 3 - 4 hours
- NC-EM40P : Approx. 4.5 - 5.5 hours

(Amount of water : Maximum / Room temper

Previous Keep-warm setting : 208)

Be sure to let milk cool down or mix it with before giving it to a baby.

Note

- After power is restored in the event of a pow set to 208, even if the "6h Timer" or the "18
- When the temperature of hot water has dro to boiling temperature again.
- Reboil may not start automatically dependi In such a case, press 'Long Boil/Reboil' key
- The keep-warm temperature or the timer ca
- When the 185 keep-warm is selected while temperature first, then drop to approx. 185° Indicator light will change from flashing to s
- If more water is added while water is being reaches a full boil. When water needs to be

Caution

- Do not use the unit near an open flame. (T
- Do not supply water directly from the tap or (If the water overflows the pot and it enters the
- Do not leave water standing in the containe
- Do not pour water out of the pot over the si (Water infiltration may cause a malfunction)

Main unit and lid

Clean with a damp, well-wrung cloth.

●Do not wet or soak the main unit in water.
(If water enters the main unit from the bottom or from the dispensing spout, it can also get into the electrical components in the main unit and may cause a malfunction.)

- Do not use detergents. (They may leave an odor.)
- Do not use benzine or thinner. (They may damage the surface.)

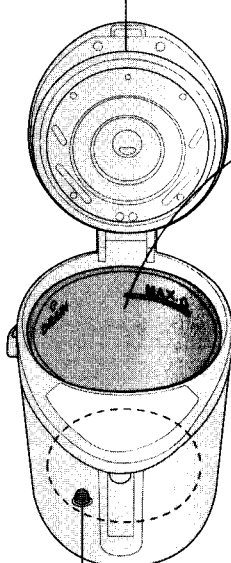
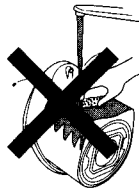

Inner container

Clean with a wet sponge.

●Do not use polishing powder, a scrub brush or a nylon brush.
(They may damage the fluororesin finish of the inner container.)

When the container shows signs of being covered with scale

While you are using this unit, minerals contained in the water (like calcium) can get stuck on the inner container or on the mesh filter. This is called "scale", and it is harmless.

- Milky-white gritty surface
- White or glittering floating material
- Discoloration in the finish like dark brown, gray, or green areas.

These are not signs of discoloration or corrosion of the inner container itself, or flakes from the fluororesin covering.



To maintain the pot's performance, clean the inner container once every two or three months using citric acid. (See P.14)

Mesh filter

Clean the filter with a brush.

When filter is clogged, water does not flow smoothly.

*After cleaning the filter, be sure to reattach it to the inner container.

Note

- Do not wash in a dishwasher and never put it in a heated dish dryer. (The unit may become deformed.)
- To store the unit, dry it thoroughly and put it into a plastic bag with a seal. Seal the bag to keep insects from getting in.

1. Make sure that the mesh filter is attached.
2. Put citric acid in the inner container.
 - Amount of citric acid to be used at one time
 - NC-EM22P: 40 g (one package) or three to four level tablespoons
 - NC-EM30P/NC-EM40P: 80 g (two packages) or seven level tablespoons
3. Add water to the maximum water level. Mix the citric acid and water well. Close the lid.
4. Connect the plug immediately after start. Then press the 'Select' key more than 3 seconds.

Cleaning start

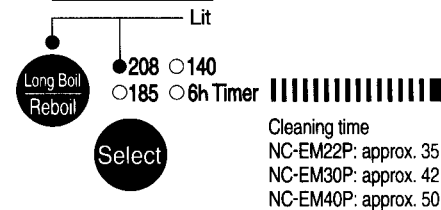

5. Unplug, remove the lid and throw away the water.
6. Refill with water and boil it to remove the scale. Then throw the hot water away via the tap.

Precautions

- Use only our citric acid to clean this thermo pot.
- Do not fill with water above maximum water level.
- Fill the container only with tap water. (Do not use distilled water.)

The citric acid is available from an automatic dispenser.

- * Follow the directions for cleaning printed on the dispenser.
- * Since the citric acid used for cleaning is a food grade, it is safe to use.

Note

- To remove any discoloration from the area around the inner container, use a wet sponge.
- If the discoloration cannot be removed by rubbing, use a wet sponge.

Before calling a service supplier, please check the following possible causes.

Troubleshooting

If...	Possible cause	How to fix
White or glittering flakes floating in the hot water.	<ul style="list-style-type: none"> ●The cause of this is "scale". (See P.13) It is not flakes of fluororesin. * Water with a large content of minerals in it such as mineral water or ionised water, is more likely to cause a scale or white layer in the hot water. 	<ul style="list-style-type: none"> ●Clean the inner container with an wet sponge. (See P. 13) ●If the "scale" won't come out, clean with citric acid. (See P. 14)
Hot water from the unit has an unpleasant odor.	<ul style="list-style-type: none"> ●Odors of chlorine remain depending on the amount of chlorine in tap water. ●When the unit is new, resin used in manufacture may give off a mild odor. This will disappear with use. ●If the unit is placed on surfaces such as a vinyl sheet, the odor may be carried over into the water. 	<ul style="list-style-type: none"> ●Press the 'Long Boil/Reboil' key to reduce the chlorine. (See P.11)
Hot water does not flow out smoothly from the dispensing spout.	<ul style="list-style-type: none"> ●The mesh filter may be clogged with "scale". (See P.13) 	<ul style="list-style-type: none"> ●Clean the filter with a brush. (See P.13) ●If the "scale" cannot be removed, replace the filter. (See P.16)
Hot water won't dispense.	<ul style="list-style-type: none"> ●The automatic lock has been engaged. 	<ul style="list-style-type: none"> ●Press the 'Lock/Unlock' key.
Hot water comes out by itself.	<ul style="list-style-type: none"> ●Water has been added above maximum water level. 	<ul style="list-style-type: none"> ●Lower the water level.
The water is not boiled.	<ul style="list-style-type: none"> ●The plug has been disconnected. 	<ul style="list-style-type: none"> ●Connect the plug.
The outside of the main unit is hot.	<ul style="list-style-type: none"> ●Since the unit keeps water warm at a high temperature, if the room temperature is very high, the outside of the main unit may reach about 130°F (55°C). This is normal. 	
The indicator lights flash alternately.	<ul style="list-style-type: none"> ●Overheating protection has been activated (See P.10) 	<ul style="list-style-type: none"> ●Add water and press 'Long Boil/Reboil' key.
	<ul style="list-style-type: none"> ●The indicator lights may flash alternately by adding boiling water or the way the water is supplied. 	<ul style="list-style-type: none"> ●Press the 'Long Boil/Reboil' key.
	<ul style="list-style-type: none"> ●When the inner container is cleaned with citric acid, citric acid have built up on the bottom. 	<ul style="list-style-type: none"> ●Disconnect the plug, and stir the citric acid well to disperse.

- If the problem is not fixed after checking the above possible causes, or if you think something may be wrong, disconnect the body plug from the unit. Wait at least 10 seconds and then re-connect the plug.
- The semi-transparent inner part inside the lid may become yellowish. This does not affect operation of the unit.
- The rattling noise in the lid is made by small ball-shaped components which prevent water from flooding out if the unit topples over.
- The clicking sound is made by the microprocessor which adjusts heating.

Rubber gaskets
 Replace gaskets if they crack, lose their plia for any other reason, allow steam to escape between the container and the lid.

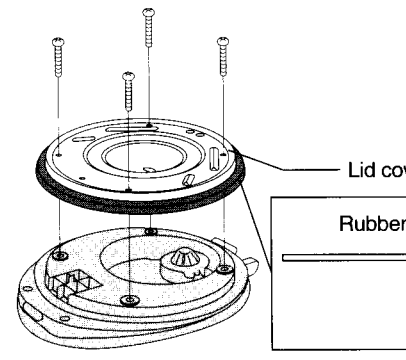

Remove lid, unscrew 4 tapping screws and the lid cover.
 Exchange the gaskets and then place the lid back and secure with the tapping screws.

Specifications

Model No.		
Power supply		
Power consumption	When boiling water	
	When keeping warm	
Average power consumption in keeping warm (Amount of water : maximum / Room temperature : 68°F (20°C))		
	at 208	app
	at 185	app
	at 140	app
Dimensions (H x W x D) When the handle is tilted		approx (approx)
Weight (including power cord)		approx
Rated capacity		approx

* Under certain conditions, such as at very high temperature, please avoid using the unit in such condition.
 * If the unit will be left unused during cold conditions, the inner container may freeze causing damage.