

PANASONIC SD-YD250 Owner's Manual

[Shop genuine replacement parts for PANASONIC SD-YD250](#)

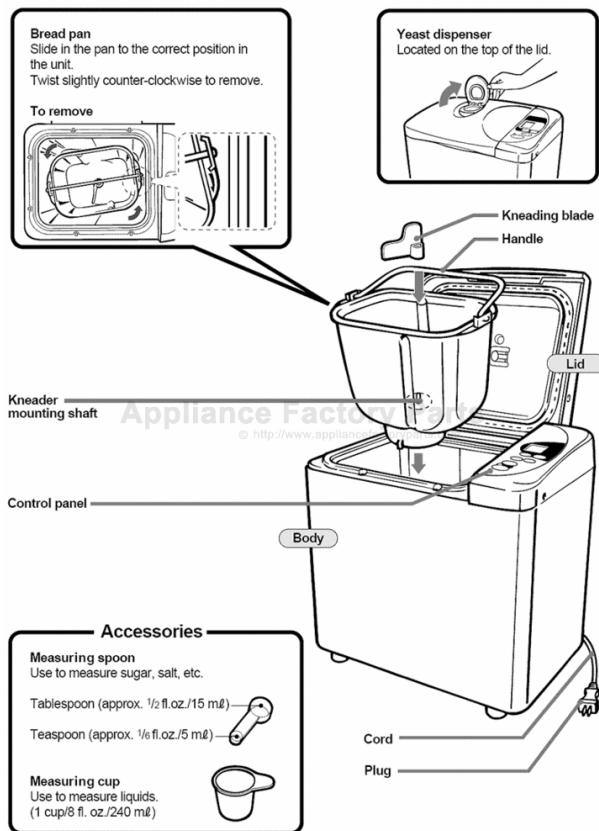

[Find Your PANASONIC Small Appliance Parts - Select From 148 Models](#)

----- Manual continues below -----

Panasonic®

SD-YD250

Bread Bakery®

Automatic Bread Maker

**OPERATING
INSTRUCTIONS
&
RECIPES**

For help or advice using your new *Bread Bakery®*,
please call 1-800-211-PANA, Monday to Friday,
9 a.m. to 9 p.m.(Eastern time), Saturday and Sunday,
9 a.m. to 7 p.m.(Eastern time)

IMPORTANT SAFEGUARDS

When using electrical appliances, basic safety precautions should always be followed including the following:

1. READ ALL INSTRUCTIONS BEFORE USE.
2. Follow all warnings and instructions marked on the product.
3. Unplug this product from wall outlet when not in use and before cleaning.
Do not immerse appliance in water or other liquid. Use a soft sponge and mild detergent when cleaning the inside of the pan or kneading blade. The cabinet may be cleaned with a cloth, dampened with a mild soap and water solution.
4. Do not touch hot surfaces. Use mitts when handling hot materials, and allow metal parts to cool before cleaning.
5. Close supervision is necessary when any appliance is used near children.
6. Do not allow anything to rest on power cord. Do not plug in cord where persons may walk on, or trip over it.
7. Do not operate any appliance with a damaged cord or plug. Refer servicing of appliance to an authorized Panasonic service center if the unit should malfunction or be damaged in any manner.
8. This appliance is not intended for commercial use. It is for household use only.
9. The use of attachments not recommended by manufacturer may cause damage or injury.
10. Avoid contacting moving parts.
11. Do not use outdoors. Do not use appliance for other than intended use.
12. Do not let cord hang over edge of table or counter, or touch hot surfaces.
13. Do not place on or near a hot gas or electric burner, or in a heated oven.
14. To disconnect, grip plug and pull from wall outlet. Never pull on cord.
15. The unit may vibrate or move during the kneading process. Do NOT place the unit near the edge of a countertop. Place the unit securely where movement of the unit will not cause it to fall off the countertop.

SAVE THESE INSTRUCTIONS

Note:

- A. A short power-supply cord is provided to reduce the risk resulting from becoming entangled in or tripping over a longer cord.
- B. Extension cords are available and may be used if care is exercised in their use.
- C. If extension cord is used:
 - (1) the marked electrical rating of the extension cord should be at least as great as the electrical rating of the appliance,
and
 - (2) the longer cord should be arranged so that it will not drape over the countertop or tabletop where it can be pulled on by children or tripped over unintentionally.
- D. This appliance has a polarized plug (one blade is wider than the other). As a safety feature, this plug will fit in a polarized outlet only one way. If the plug does not fit fully in the outlet, reverse the plug. If it still does not fit, contact a qualified electrician. Do not attempt to defeat this safety feature.

Table of Contents

Basic principles when baking with <i>Bread Bakery</i> ®	3
-Basic features	3
Baking programs.....	4
Parts identification	5
Control panel-display/functions.....	6
How to use.....	7—12
-To use the timer for baking loaves only with the BAKE option.....	10
-Using the BAKE RAPID option.....	10
-Using the DOUGH option.....	11
-Using the BAKE ONLY program.....	11—12
How to clean.....	12
Slicing and storing the bread	13
Leakage of bread ingredients from the bread pan.....	13
Specifications	13
Display indications for abnormal conditions	14
Before calling for service	15—16
Ingredients.....	17—18
Other ingredients used for flavored loaves	19
Tips for baking whole wheat & multigrain breads	19
Differences in baking results	20
Recipes.....	21—33
Basic recipes	21—23
Whole wheat recipes.....	24—25
Multigrain recipes.....	26
French recipes.....	27
Dough recipes.....	28—30
Pizza dough recipes.....	31
Bake only recipes	32—33
Warranty.....	34

Basic Features

MENU Bread programs available:

- BASIC. For producing loaves of bread using strong wheat flour (bread flour).
 WHOLE WHEAT. . . . For loaves using whole wheat flour as the main ingredient.
 MULTIGRAIN. For breads with cereals/grains such as rye, millet, soy, corn etc. mainly using wholemeal strong flour.
 FRENCH For loaves with crisp crust and open texture. The taste is crisp because sugar is not included in the ingredients.
 PIZZA A rapid dough program for pizza, focaccia and other Italian breads.
 BAKE ONLY A program for baking cakes only.

SELECT Baking options available:

- BAKE The unit automatically mixes ingredients, kneads the dough, rises it and bakes it.
 BAKE RAPID The unit mixes ingredients, kneads the dough, rises it and automatically bakes it faster than the standard BAKE option.
 BAKE SANDWICH. . . The unit automatically makes a medium size loaf of bread with a soft crust suitable for sandwich slices.
 BAKE RAISIN The unit automatically makes bread as in the BAKE option. A beeper sounds to let you know when to add dried fruits, such as raisins. This is to prevent them from being crushed during the kneading process.
 DOUGH The unit automatically prepares dough for pizzas, dinner rolls, donuts, croissants, etc.
 DOUGH RAISIN The unit automatically prepares dough as in the DOUGH option. A beeper sounds to let you know when to add dried fruits as in the BAKE RAISIN option.

A 13-hour timer allows you to prepare everything the night before and wake up to the aroma of freshly baked bread. (Certain BAKE options only). The result may differ when the timer is used.
 The beep sounds eight times when baking on the BAKE option or rising of dough on the DOUGH option is completed.
 The beep also sounds in the BAKE RAISIN and DOUGH RAISIN option, when the machine pauses for 1 minute during the kneading process to add the raisins, chopped dried fruits and / or nuts.

SIZE and **CRUST** Choices

The choice of size and crust color is possible for the following options:
 If not selected, the *Bread Bakery*® will automatically select XL size with a medium crust.

	Size Selection			Crust Colour Selection		
	XL	L	M	Dark	Medium	Light
basic BAKE	✓	✓	✓	✓	✓	✓
basic BAKE RAPID	✓	✓	✓	✓	✓	✓
basic BAKE RAISIN	✓	✓	✓		✓	✓
whole wheat BAKE	✓	✓	✓			
whole wheat BAKE RAPID	✓	✓	✓			
whole wheat BAKE RAISIN	✓	✓	✓			

- Size and crust colour will be affected by the room temperature and the quality of flour and/or other ingredients.

Baking programs

- NOTE:**
- The duration of each process is approximate and will vary according to the ambient temperature.
 - The following time is when the timer is not used. (The availability to choose the timer is indicated with a tick (✓) in the “timer” column.)
 - There will be keep-warm of up to 60 minutes after the baking is complete until the STOP pad is pressed, for all BAKE options. The keep-warm is not available for the DOUGH option and the BAKE ONLY option.
 - For BAKE RAISIN & DOUGH RAISIN options, there will be a break of 3 minutes during the kneading process to add dried fruits and nuts.

BAKE options

		Basic Bake Basic Bake Sandwich	Basic Bake Rapid	Basic Bake Raisin	Whole Wheat Bake Whole Wheat Bake Sandwich Multigrain Bake	Whole Wheat Bake Rapid	Whole Wheat Bake Raisin	French Bake	Bake Only
P r o c e s s	Rest	30 ~ 60 min	—	30 ~ 60 min	60 ~ 90 min	15 min	60 ~ 90 min	40 min ~ 1 hr 55 min	—
	Knead	15 ~ 30 min	15 ~ 20 min	15 ~ 30 min	15 ~ 25 min	15 ~ 25 min	15 ~ 25 min	10 ~ 20 min	—
	Rise	1 hr 50 min ~ 2 hr 20 min	approx. 1 hour	1 hr 50 min ~ 2 hr 20 min	2 hr 20 min ~ 2 hr 50 min	approx. 1 hr 40 min	2 hr 20 min ~ 2 hr 50 min	2 hr 55 min ~ 4 hr 10 min	—
	Bake	50 min	35 min	50 min	50 min	45 min	50 min	55 min	30 ~ 90 min
Total		4 hours	1 hr 55min	4 hours	5 hours	3 hours	5 hours	6 hours	30 ~ 90 min
Timer		✓			✓			✓	

DOUGH options

		Basic Dough Basic Dough Raisin	Whole Wheat Dough Whole Wheat Dough Raisin Multigrain Dough	French Dough	Pizza Dough
P r o c e s s	Rest	30 ~ 50 min	55 ~ 75 min	40 min ~ 1 hr 35 min	—
	Knead	15 ~ 30 min	15 ~ 25 min	10 ~ 20 min	10 ~ 15 min
	Rise	1 hr 10 min ~ 1 hr 30 min	1 hr 40 min ~ 2 hours	1 hr 45 min ~ 2 hr 40 min	10 ~ 15 min
	Knead	—	—	—	Approx. 10 min
	Rise	—	—	—	Approx. 10 min
Total		2 hr 20 min	3 hr 15 min	3 hr 35 min	45 min
Timer					

Parts identification

Bread pan

Slide in the pan to the correct position in the unit.
Twist slightly counter-clockwise to remove.

To remove

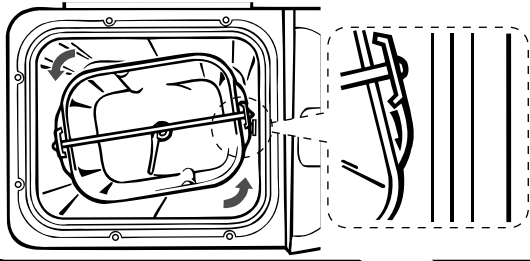

Yeast dispenser

Located on the top of the lid.

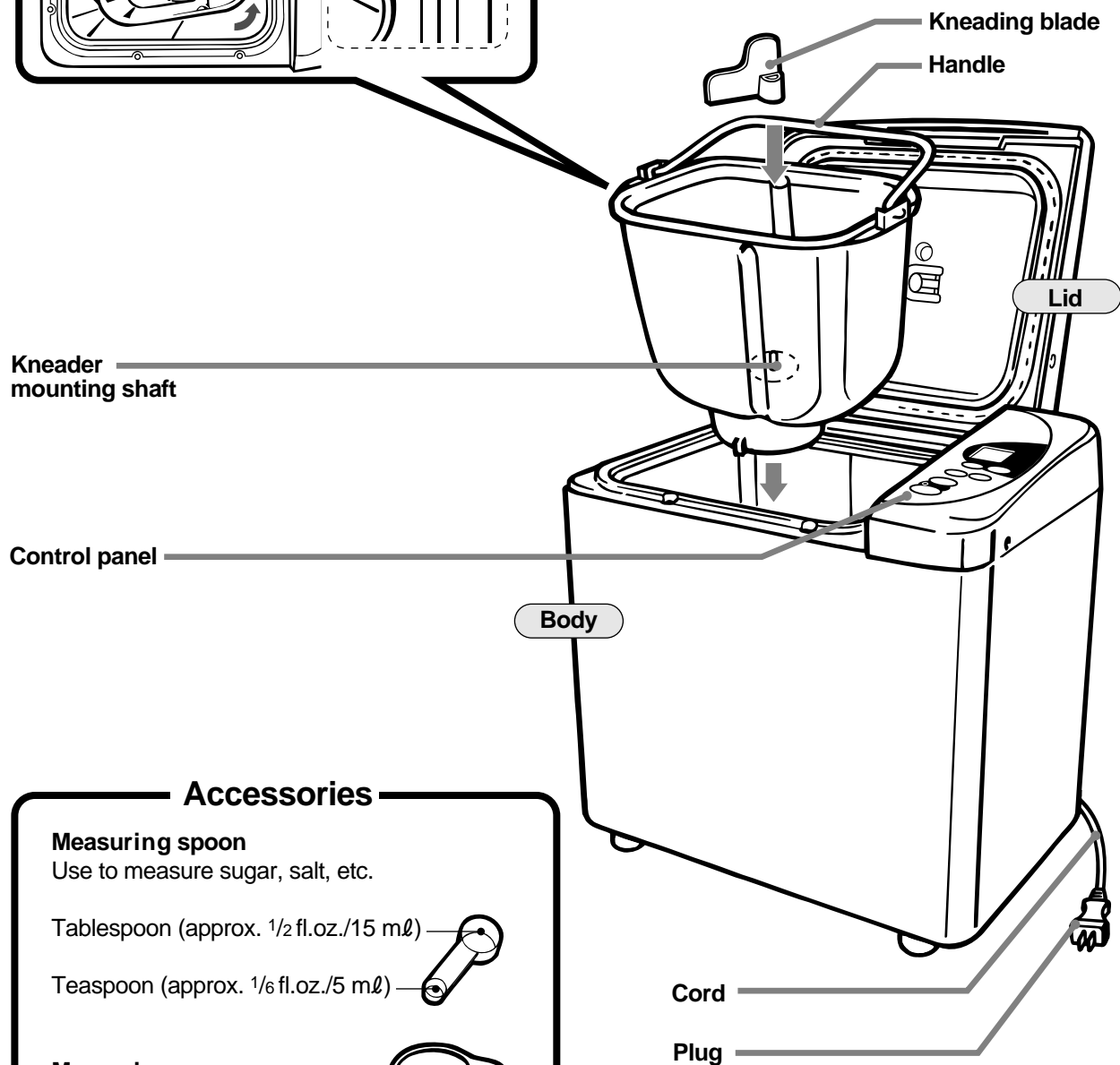
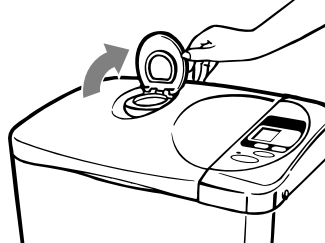

Accessories

Measuring spoon

Use to measure sugar, salt, etc.

Tablespoon (approx. 1/2 fl.oz./15 ml)

Teaspoon (approx. 1/6 fl.oz./5 ml)



Measuring cup

Use to measure liquids.
(1 cup/8 fl. oz./240 ml)



Control panel-display/functions

Be sure you understand the function of each pad before using the *Bread Bakery*®.

NOTE: The unit has a protective film overlay on the control panel to prevent scratching or marring during shipping.

You may peel this film off and discard it.

Display window

All modes and indications are shown here for reference.

MENU

Press to select the type of bread: basic, whole wheat, multigrain, french, pizza or bake only. (It is not necessary to press this pad for basic.) Each time the pad is pressed, the display will change accordingly.

SELECT

Press to choose the bake option: BAKE, BAKE RAPID, BAKE SANDWICH, BAKE RAISIN, DOUGH or DOUGH RAISIN. (It is not necessary to press this pad for BAKE.) Each time the pad is pressed, the display will change accordingly.

SIZE

Press this pad to select the size of the loaf for: BAKE, BAKE RAPID & BAKE RAISIN options of basic and wholewheat bread.

CRUST

Press this pad to select the color of the crust for BAKE, BAKE RAPID & BAKE RAISIN options of basic bread.

TIMER

Press this pad to set the timer and to set the baking time for the bake only option. The time will advance 10 minutes each time this pad is pressed. (1 minute for the bake only option.) The timer setting will change rapidly if constant pressure is applied to the pad.

Indicator light



The red light will be lit when in operation. It will flash when the bread baking or the dough making is completed. It will also flash in a different frequency when operated in abnormal conditions.

START/STOP

Press this pad to start operation or begin the timer. Press this pad to stop operation or cancel the timer setting. To stop operation, the pad must be pressed and held for 1 second.

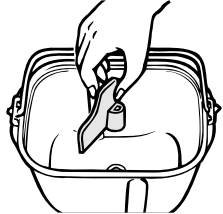
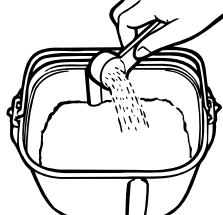
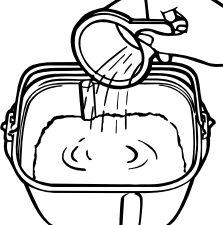

How to use

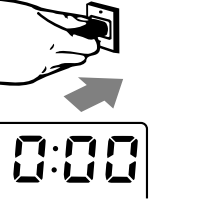
	Steps	Notes
1	 <p>Remove the bread pan from the unit. Twist slightly counter-clockwise and pull up, using the handle. Mount the kneading blade on the shaft. Make sure that the kneading blade and the kneading shaft are free of bread crumbs.</p>	<p>The kneading blade is designed to fit loosely on the shaft with some room for turning.</p>
2	 <p>Place all the ingredients <i>except the liquids and dry yeast</i> inside the bread pan.</p> <p>RAISIN modes only You may place dried fruits later when the beeper sounds to prevent them from being crushed (see step 10.)</p>	<p>See recipes on P. 21-33. Flour, dry milk, salt, sugar, butter, etc., first.</p>
3	 <p>Pour water and other liquids, if any, into the bread pan.</p>	
4	 <p>Place the bread pan inside the body. Be sure the bread pan contacts the bottom of the unit. Turn the handle down.</p>	<p>Wipe off any moisture or foreign matter from the outside of the bread pan before placing it in the unit. If the bread pan is not placed correctly, the dough will not be kneaded properly.</p>
5	 <p>Yeast dispenser lid</p> <p>Close the top lid. Fill the yeast dispenser with the correct amount of dry yeast. After START/STOP is pressed, the yeast will automatically drop into the bread pan at the proper time. Close the yeast dispenser lid.</p>	<p>If any moisture remains on the dispenser, the yeast may not drop completely.</p>
6	 <p>Close the top lid. Plug into a 120 volt outlet. 0:00 appears. DO NOT press START at this stage (The machine will default to an extra large basic bread with medium crust, if START is pressed now.). Select your program first.</p>	<p>Position the unit away from edge of the table or counter-top. The unit may vibrate or move during the kneading process. Place the unit where it will not fall off should the unit move during the kneading process.</p>

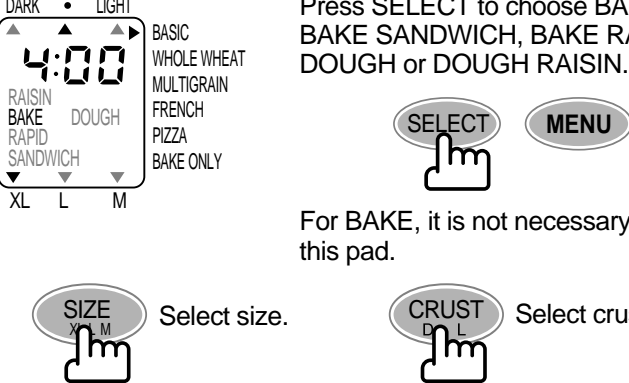
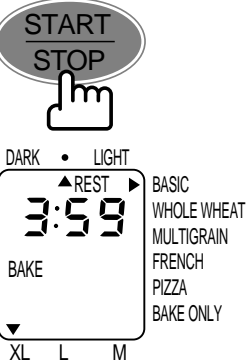
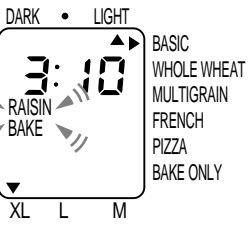
	Steps	Notes
<p>7</p>  <p>Press SELECT to choose the type of bread indicated on the right of display.</p> <p>Keep pressing the pad to move the arrow down the list of bread types.</p> <p>For basic, it is not necessary to press this pad.</p> <p>For bake only program, refer to P.11 — 12 for instructions.</p>	<p>See P. 3 for choice of bread programs.</p>	
<p>8</p>  <p>Press SELECT to choose BAKE RAPID, BAKE SANDWICH, BAKE RAISIN, DOUGH or DOUGH RAISIN.</p> <p>For BAKE, it is not necessary to press this pad.</p> <p>Select size.</p> <p>Select crust color.</p>	<p>See P. 3 for choice of baking options.</p> <p>The option you require will flash.</p> <p>See availability of size and color selection on P. 3.</p>	
<p>9</p>  <p>Press START/STOP. When the red light comes on, the program is set and no pads are now operable.</p> <p>“REST ” begins.</p> <p>The resting settles the temperature of the bread pan and ingredients.</p> <p>After rest, the process will proceed to knead, then to rise and finally, bake.</p> <p>The time remaining until the bread is finished is displayed in hours and minutes. (3:59, 3:58 . . .)</p> <p>Note: To cancel, press START/STOP and hold for 1 second. The display will go blank, begin again from step 7.</p> <p>The above display is for basic—BAKE, XL size, medium colour.</p>	<p>When TEMP blinks, see P.14.</p> <p>There will be no mixing action during resting.</p> <p>A clicking noise may be heard during operation. This is not a malfunction.</p> <p>For information of the process of each option, see P. 4.</p> <p>The time required for each of the steps will vary according to factors such as voltage fluctuation and room temperature.</p>	
<p>10</p> <p>RAISIN options only</p>  <p>In the last part of kneading, there will be two sessions of beep sound. RAISIN on display will blink and kneading will stop for 3 minutes.</p> <p>Add the dried fruits during this period to prevent them from being crushed.</p> <p>Close the lid and leave the unit.</p> <p>When 3 minutes have passed, kneading will begin again and the RAISIN will stop blinking.</p> <p>The above display is for basic-BAKE RAISIN, XL size, light color.</p>	<p>The raisin beep will sound :</p> <p>For basic: 42~72 minutes from Start.</p> <p>For whole wheat: 72~102 minutes from Start.</p> <p>Do not put your finger in the dough, or touch the bread pan while adding the dried fruits.</p> <p>During operation, do not remove the pan, nor unplug the power cord.</p> <div style="border: 1px solid black; padding: 5px; width: fit-content;"> <p>The timer cannot be used for this option.</p> </div>	

Steps

Notes

11

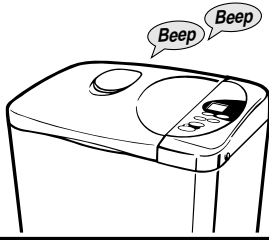

The beeper will sound eight times and the indicating light will flash when the bread is baked, or the dough is completed.

12

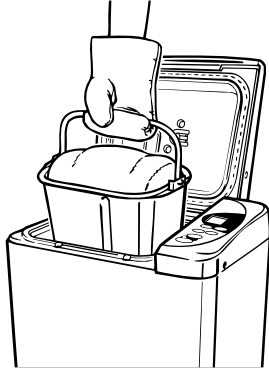

Press START/STOP.
Promptly open the lid and remove the bread pan using oven gloves.
Note: If the START/STOP is not pressed and the bread pan is not removed, the unit proceeds to keep the bread warm for 1 hour or until START/STOP is pressed to prevent condensation of the steam.
For DOUGH options, follow each recipe directions for further steps instructed in the cook book.

**The bread pan will be very hot.
Do not place it on any plastic surfaces. Handle carefully.**

If the bread is left in the unit, further browning of crust color may occur.

13

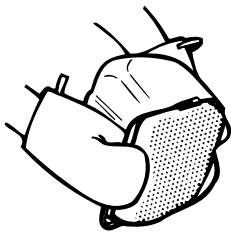

Turn the pan upside down.
Shake the pan several times to release the bread.

If the kneading blade comes out with the bread, use a heat-resistant plastic utensil to remove it.

For DOUGH options, when baking is completed, remove from the oven, using oven gloves.

The bread and the kneading blade will be very hot.

A metal utensil may scratch the finish of the kneading blade.

14

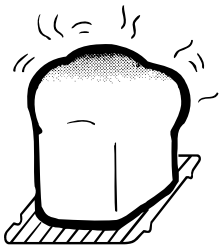

Place the bread on a wire rack to cool and allow the steam to escape.

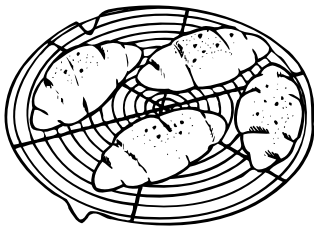

See Slicing and storing the bread on P. 13.

15



Unplug after use.

—Allow at least 1 hour for the unit to cool down before the next use.

To use the timer (BAKE option only)

Follow the same steps as in pages 7– 9 except step 9.
For step 9, follow the instructions below.

Steps	Notes
 <p>Press TIMER to set the amount of time in which you want the bread to be ready.</p> <p>Time may be set for any length of time from 4 hours to 13 hours for BASIC, from 5 hours to 13 hours for WHOLE WHEAT and MULTIGRAIN, from 6 hours to 13 hours for FRENCH.</p>	<p>See P. 6 for further explanation of the TIMER pads.</p>

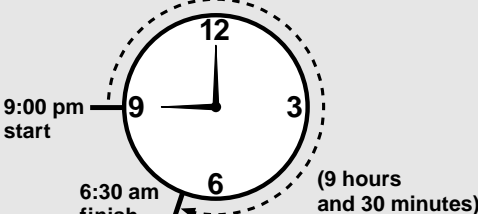



Example:
If the present time is 9:00 pm, and you want the bread to be finished at 6:30 am tomorrow morning, set the timer to *9:30* (9 hours and 30 minutes), the time required until the completion of the bread.

  <p>The above display is for basic-BAKE, XL size, medium colour.</p>	<p>Press START/STOP.</p> <p>The time remaining before the bread is finished is displayed in hours and minutes.</p> <p>There will be no action while the timer is working.</p>
--	--

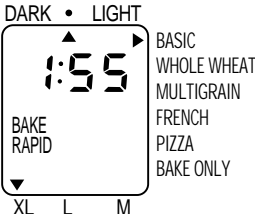

Using the BAKE RAPID option

Follow the previous steps 1-6. For step 7, choose either **BASIC** or **WHOLE WHEAT** (there is no **BAKE RAPID** option for the **MULTIGRAIN** or **FRENCH**). For steps 8 & 9, follow the instructions below.



	<p>Press SELECT pad to choose BAKE RAPID.</p> <p>Then select size and crust colour.</p>
	 <p>The remaining time is displayed in hours and minutes.</p> <p>The above display is for BASIC-BAKE (RAPID) option, XL size, medium color.</p> <div style="border: 1px solid black; padding: 2px; text-align: center;">The timer cannot be used for this option.</div>



Using the DOUGH option

Follow the previous steps 1–7.

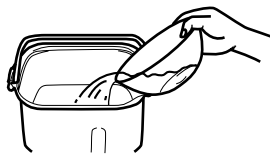
	Steps	Notes
8	 Press SELECT to choose DOUGH or DOUGH RAISIN. Note: For PIZZA DOUGH, press select until the arrow points at it. You do not have to press SELECT.  Press Start pad. DOUGH will stop flashing.	Dough will flash. The resting settles the temperature of the bread pan and ingredients.
9	<p>The beeper will sound eight times and the indicating light will flash when the dough is completed. Press STOP pad when the beeper stops. Remove the bread pan. Close the lid. Unplug after use.</p>  The display will go out when the beeper stops, but the indicating light will flash until the STOP pad is pressed.	
10	Shape and give dough final rising before baking in a conventional oven as per the recipes given.	
11	When baking is completed, remove from the oven, using your oven gloves and cool on a wire rack.	The timer cannot be used for this option.



Using the bake only program

	Steps	Notes
1	 Prepare cake in a separate mixing bowl.	Follow instructions in the Cookbook for details.
2	 Place the mixture carefully into the lined bread pan. (The kneading blade must be removed.)	Ensure that the bread pan is lined with baking parchment so the cake mixture does not touch the sides.
3	 Press select to choose BAKE ONLY.	

	Steps	Notes
4	 <p>Press TIMER to set the required time. (Between 30 to 90 minutes.) The Timer cannot be used to delay the start of baking.</p>	Time indication starts from 30 minutes and moves up to 1 hour 30 minutes in 1 minute increment.
5	 <p>Press START / STOP.</p>	
6	<p>Note: Upon completion of baking, you may check the consistency of the baked product by piercing the centre with a skewer. If the baking is still insufficient, you may additionally bake by repeating above steps 3 & 4, after START/STOP has been pressed. The additional baking time may be set as long as the accumulated baking time does not exceed 90 minutes.</p>	<div style="border: 1px solid black; padding: 5px;"> <p>When checking with a skewer, take utmost care not to burn yourself as the oven cavity will be extremely hot.</p> </div>

How to clean

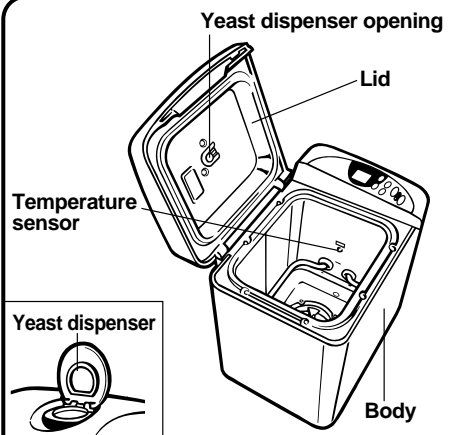
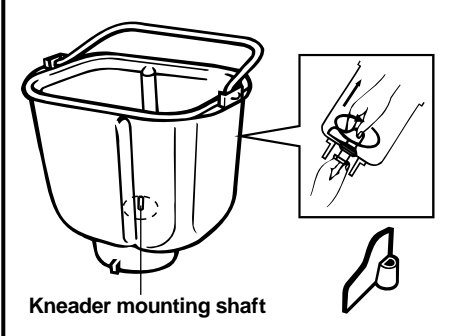
Before cleaning the unit, unplug and allow the unit to cool.

	<p>Body and Lid Body and lid should be wiped clean with a damp cloth. Use only mild liquid detergent. For baked-on materials, use a non scratch scourer and detergent on the interior. Do not use cleansers, steel wool pads, or other abrasive materials. Do not use benzine, thinner, alcohol, etc.</p> <p>Temperature sensor Wipe gently and avoid deforming the temperature sensor.</p> <p>Yeast dispenser Wipe clean with a dry cloth. If a damp cloth is used, the dispenser must be dry completely before reuse.</p>
	<p>Bread pan and kneading blade If the kneading blade cannot be easily removed from the pan by twisting the mounting shaft, pour lukewarm water into the cooled pan and allow to soak for 5—10 minutes. Remove the blade. Always remove the blade and wash the pan with mild, liquid detergent after each use. DO NOT SUBMERGE THE PAN IN WATER. Do not use other abrasive materials or the pan may be scratched. These parts are not dishwasher safe.</p>
	<p>Measuring cup and spoon Rinse and wipe dry.</p>

1. Be sure that the unit and the bread pan have dried completely before storing.
2. On the interior of the body some discolouration may occur with use.

Slicing and storing the bread

Cool the bread on a wire rack before slicing or storing.

Slicing homemade bread

Homemade bread can be cut with a bread knife.

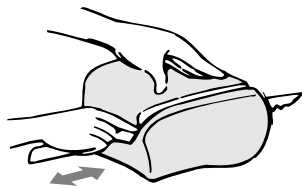

Place the loaf on its side and cut with a sawing motion.

Storing homemade bread

After cooling the bread completely at room temperature, wrap it in a foil or a plastic bag to preserve freshness.

To enjoy the taste of freshly baked homemade bread, try to consume your bread as soon as possible.

For longer storage, wrap well and store in the freezer.

It is better to slice the loaf before freezing.

Leakage of bread ingredients from the bread pan

With extended use, a small quantity of ingredients may leak out from the outlet of the bread pan. This is normal. The bread pan is designed so that the ingredients in the kneader mounting shaft unit may be discharged to prevent rotation stoppage.

When the kneader mounting shaft does not rotate, it is necessary to replace the kneader mounting shaft unit with a new one.



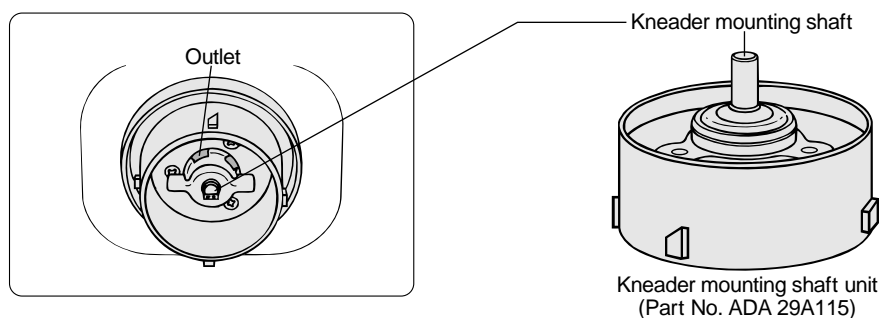

Consult with your authorised Panasonic Service Centre for servicing or for purchase of replacement parts.

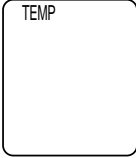
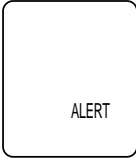

Specifications

Power supply	120V AC 60 Hz
Power consumed	550 W
Capacity	max. 21 ³ / ₄ oz./620 g of bread flour min. 14 ³ / ₄ oz./400 g of bread flour
Timer	Digital timer (up to 13 hours)
Protective device	Self-resetting motor protector
Dimensions (H X W X D)	approx. 14 X 13 ¹ / ₃ X 9
Weight	approx. 15 lbs.
Accessories	Measuring cup, measuring spoon

Display indications for abnormal conditions

Condition	Reason/Cause	How to reset/restart
 <p>TEMP appears on display.</p>	<p>The unit is hot (above 40°C/105°F). This may occur during repetitive use. You must allow the unit to cool down before reusing.</p>	<p>Leave the unit as it is.</p> <p>When the unit has cooled to below 105°F/40°C, TEMP will disappear from the display window and the red indicating light will go out.</p> <p>This indicates that the unit is now ready to use.</p>
 <p>ALERT is on display.</p>	<p>There has been a 10-minute or less power cut. (The power plug has been inadvertently pulled out or the breaker has activated.) Or there has been a slight change in the power supplied to the machine.</p>	<p>If the interruption in the power supply is momentary, the operation will not be affected.</p> <p>If the power is restored within 10 minutes, the bread maker will operate again. However, the bread may not turn out well.</p>
 <p>0:00 is on display.</p>	<p>There has been more than 10 minutes of power loss due to power failure, unplugging of the power cord, or a malfunctioning of household fuse or breaker.</p>	<p>Remove the dough and start again using all new ingredients.</p>
<p>Not baked at all, although the operation appears to have proceeded.</p>	<p>Motor protection device has activated. This only happens when the unit is overloaded and an excessive force is applied to the motor. After about 30 minutes, the motor automatically starts running again.</p>	<p>Check to see if the kneader mounting shaft can rotate.</p> <div style="display: flex; justify-content: space-around; align-items: center;"> <div style="text-align: center;">  <p>Yes</p> <p>Make sure you did not use too much or too hard/heavy ingredients, then start again using all new ingredients.</p> </div> <div style="text-align: center;">  <p>No</p> <p>Service will be required.</p> </div> </div>

Motor protection device

If the unit is overloaded and an excessive force is applied to the motor, the protection device will stop the motor. After approximately 30 minutes, the motor will automatically start running again. It is recommended to restart with fresh ingredients.

Remedy 1

If the kneading blade is restricted by hard dough, take out the dough. The unit will restart 30 minutes later.

Remedy 2

Check to see if the kneader mounting shaft of the bread pan can rotate. If it can rotate, restart the bread maker after 30 minutes. If it cannot rotate, service will be required.

Before calling for service

		BAKING RESULTS:				
		Neither the indicating light nor the display light up.	Smoke emitted from steam vent. Burning smell.	Sides of bread collapse and bottom is damp.	Bread rises too much.	
		<p>Please check the following:</p> 				
OPERATIONAL ERRORS	Unplugged.		<input type="radio"/>			
	Ingredient spilled on heater element.			<input type="radio"/>		
	Power interruption (display 0:00).					
	Start/Stop pad was pressed after starting.					
	Top lid was open during operation.					
	Selection was wrong (DOUGH option was chosen).					
	Bread left in bread pan too long after baking.				<input type="radio"/>	
	Bread sliced just after baking (Steam was not allowed to escape).					
	Water added after kneading flour.					
	Kneading blade not installed properly in pan.					
INGREDIENT PROBLEMS	MEASUREMENT ERRORS	Flour	Not enough			
			Too much			<input type="radio"/>
		Yeast	Not enough			
			Too much			<input type="radio"/>
			No yeast			
		Water	Not enough			
	Too much				<input type="radio"/>	
	No sweetening agents					
	Ingredients used other than prescribed.					<input type="radio"/>
	Flour	Old flour used.				
		Wrong type of flour used.				<input type="radio"/>
	Yeast	Yeast not placed in pan first, or liquids touched yeast before kneading.				<input type="radio"/>
		Old yeast used.				
Wrong type of yeast used.						
Temperature of water was either too hot or too cold. (Not within optimum temperature range of 68 ± 8°F/20 ± 5°C.)						

Collapsed after over-rising.	Bread doesn't rise enough.	Unleavened or not leavened enough				Not baked.	Slices unevenly and is sticky.
		Top of bread floured.	Under-browned and sticky.	Browned and floured sides, center sticky and raw.	Sides brown but flour coated bottom.		
			○			○	
			○			○	
						○	
						○	
							○
		○		○			
○							
			○				
	○				○		
○							
	○						
	○						
	○						
	○						
	○						
	○						
	○						
	○						
	○						

Ingredients

Since the bread program on your Automatic *Bread Bakery*® is completely computerised, the success of your loaf depends on the quantity and quality of the ingredients

Flour:

Wheat flour provides the bulk and structure of bread. Flour is classified into two types, strong flours which are milled from hard wheat and weak flours which are milled from soft wheat. The difference in the two types of wheat is the content of proteins that form gluten (gluten is the important constituent of bread which provides its structure and its stretchy, chewy texture. Gas which is released during fermentation is trapped within the elastic network of gluten, thus making the dough rise. Gluten development mostly takes place during dough kneading).



Strong flours contain a high content of protein necessary for the development of gluten. Always use strong flour - labelled as suitable for bread making when using the recipes in this book.

Weak flour such as cake flour and pastry flour, are less in protein content and are suitable for products which have a light, crumbly texture and do not require much gluten development.

All purpose flour is used for many purposes, as the name suggests, in home baking. It is slightly weaker than bread flour. In our recipes, it is blended with the bread flour and not used alone.

Self rising flour is a white flour to which baking powder and sometimes salt have been added.

Weak flours, all purpose flour and self-rising flour may not be substituted for bread flour in the included recipes.

Whole wheat flour is made by grinding the entire wheat kernel, including the bran and germ. 100% whole wheat bread or breads containing a high percentage of whole wheat flour will be lower in height and heavier in texture than bread baked with a high percentage of bread flour. This is because the gluten strands are cut by the edges of bran flakes and the germ, rich in minerals, inhibits fermentation.

Rye flour contains some proteins but these do not form sufficient gluten. Therefore, bread baked with rye flour will be dense and heavy. When a recipe in this book calls for rye flour, do not use more than the stated quantity, as it could overload the motor.

Other flour: Products milled from other grains are occasionally used in bread. i.e. corn meal, rice, millet, soy, oat, buckwheat and barley flours. These do not contain protein that form sufficient gluten and therefore they should not be substituted for bread flour in the recipes. For gluten free bread making see page 6. Do not add more than the stated amount in the following recipes, otherwise a good result will not be achieved.

Sugars:

Sugars or sweetening agents have the following purposes in bread making:

- They add sweetness and flavour.
- They add softness and fineness to the texture.
- They give crust colour.
- They contribute to keeping qualities by retaining moisture.
- They provide food for yeast.

Besides granulated sugar or caster sugar, brown sugar, honey and molasses can be substituted in the recipes. Recipes including fruit generally require less added sugar due to the high sugar content of the fruit.



Fats:

The major purpose of fats in bread baking are:

- They tenderize the bread.
- They add flavour and richness.
- They contribute to keeping qualities by retaining moisture.

Any fat can be used, however, we recommend butter for the best flavour and texture.



Ingredients

Milk and milk products:

Their main purposes are:

- They enhance flavour.
- They increase the nutritional value of bread.
- Milk solids include protein, lactose (milk sugar), and minerals.

Most recipes call for the use of milk powder.

NEVER use fresh milk on the overnight programme. Otherwise it may sour during the rest time, spoiling the final flavour.



Salt:

Salt has the following functions in bread baking.

- It strengthens gluten structure and makes it more stretchable.
- It inhibits yeast growth.
- It enhances the flavour.

Therefore, too much salt will inhibit fermentation whereas too little will result in weak gluten structure. Both will result in a bread with low volume and poor texture. Use ordinary table salt. DO NOT USE coarsely GROUND SALT.



Liquid:

Cold tap water should be used.

(For BAKE RAPID, lukewarm water should be used, especially during the very cold winter months.)

Cold fresh milk can be substituted to improve the keeping quality and nutritional value of the loaf, which will have a softer browner crust.

NEVER use fresh milk on the overnight program.

Always measure the liquid stated in the recipe carefully, using the measuring cup provided.

TOO MUCH LIQUID will cause the dough to collapse, giving a poor appearance.

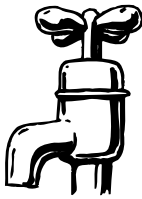

Yeast:

Yeast is a living organism, a microscopic plant which works as a leavening agent in bread baking. It acts on sugars and changes them into carbon dioxide gas and alcohol.

This gas production causes the leavening or the rise of yeast dough.

The alcohol evaporates during baking.

Yeast is available in two forms: fresh and dry. Dry yeast is available in two types; the type that requires preliminary fermentation and the type that is used dry and may be mixed with other ingredients.

For *Bread Bakery*®, use the latter type. **Do not use fresh yeast or dry yeast that requires preliminary fermentation.** Always use yeast marked active dry, instant or breadmachine yeast on the packet. Do not dissolve yeast in water before use. It is placed dry in the bread pan first, before all other ingredients.

As there is an optimum temperature for yeast to activate, your *Bread Bakery*® incorporates a heat sensor to keep the dough at the correct temperature during the rising process.

We use the minimum quantity of yeast required in our recipes to avoid spoiling the flavour of the finished loaf.

Yeast must be stored in the refrigerator for short term storage.

For longer storage, keep in the freezer.

Its reactions to temperature are as follows:

34°F.....	Inactive (Storage temperature)
60°F to 70°F.....	Slow action
70°F to 90°F.....	Best growth (Fermentation and proofing temperatures for bread growth)
Above 120°F	Yeast is killed

Chemical leaveners

Chemical leaveners are those that release gases produced by chemical reactions. Chemical leaveners used in this book are baking soda (sodium bicarbonate) and baking powder.

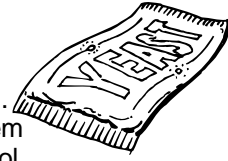

Other ingredients used for flavored loaves

Egg:

These are sometimes added to nutritionally enrich the dough, they also improve the keeping properties and colour of the baked product. Medium sized eggs are used.

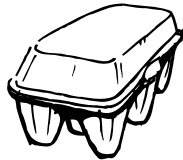

Fruits:

Dried fruits are used in some of the following recipes. Total weight of dried fruits used should not exceed recommendations in the recipes. When using fresh fruit, use only as directed in the following recipes, as the water content of the fruit will affect the loaf volume.



Bran:

Approximately 4—5 tbsp can be added to boost the fibre content. (Do not use more than this recommended amount as it will affect the volume of the loaf). Bran cereals may be used in more quantities. Refer to recipes.



Wheat germ:

Approx 60 ml (4 tbsp) can be added to give a nuttier flavour.

Herbs:

Herbs are used to add flavour to the bread. These can be used fresh or dried. If using dried herbs only small amounts (1—2 tsp) are required. For fresh herbs follow the guidelines in the recipes.

Vitamin C (Ascorbic Acid):

Ascorbic acid is a bread improver i.e. it helps improve the volume of the loaf. This is now incorporated into the Fast Action Easy Bake yeast and does not have to be added as a separate ingredient, although we recommend adding 1/4 tsp Vitamin C powder to certain whole wheat loaves to improve the rise.



Nuts:

Nuts may be used, but chop them finely. Use no more than the recipe recommends. The height of bread when nuts are used, may be low because the chopped nuts will cut the gluten structure.



When adding nuts as well as dried fruit, their total weight should not exceed that recommended in the recipes. Remember to chop them finely as these interfere with mixing.

Spices:

Spices are used to add flavour to the bread. Only small amounts (1 teaspoon to 2 teaspoon) are required.



Seeds:

These may be added to give flavour and texture to the bread. Be careful if using larger seeds, that are particularly hard, as they could scratch the non-stick coating.

Tips for baking whole wheat and multigrain breads

The result of breads, such as whole wheat breads and multigrain breads, are affected greatly by the quality of ingredients, especially the flour. The flour quality is affected by the keeping methods, the temperature, humidity, etc. Another important factor about the flour is that its quality also differs from year to year, season to season due to the quality of the wheat crop affected by the weather.

Sometimes due to bad weather conditions, the crop may not grow with as much gluten forming properties as it would require to produce flour for making excellent breads.

When the quality of flour is poor, the bread may not rise, or collapse after rising due to weak gluten. In such cases, take the following measures to obtain better results.

1. At least 1/8 of the flour (about 7 oz.) should be white bread flour, rather than whole wheat flour.
- and/or 2. Reduce 1/8 cup to 1/4 cup of water from the regular amount.

If above still does/do not solve problems,

3. Reduce the amount of dry yeast to 1 teaspoon.

The loaf produced by above methods may be low or small.

Differences in baking results

Baking results differ according to several factors including the environmental conditions, electricity fluctuation, choice of ingredients and their brands, measurement and quality. To avoid poor baking results, the following should be remembered:

✂ Bake at optimum temperature.

Temperature is one of the most important factors in bread baking. Although the *Bread Bakery*® is designed to sense the temperature and automatically control the heating system during the entire process of baking, it should be remembered that fair results may be obtained only if the room temperature is 41°F to 86°F. For optimum results, bake in a room between 68°F to 77°F.

Temperature of ingredients will also affect the bread result. Although it is best to have all the ingredients the same temperature as the room temperature (that is, within the optimum temperature range), the temperature of ingredients are often very difficult to control. The temperature of water is the easiest to adjust. When using BAKE RAPID mode and the room temperature is very cold, between 41°F—50°F, adjust water to approximately 68°F.

Other environmental factors such as humidity and altitude may affect the bread result. In normal room humidity, the effect may be slightly seen in the color and the luster of the crust. Experimentation will be necessary regarding the correct amount of yeast to be used at different altitudes.

✂ Measure the ingredients accurately.

Accurate measurement is essential in achieving good baking results. Weighing the ingredients would be more accurate than measuring them in cups. This is why in this book's recipes, many ingredients are given in weight as well as in cup/spoon measurements.

The only ingredients that may be appropriate in measuring by volume, that is, by cups and spoons, are liquids and very small quantities of dry ingredients, such as the yeast and spices. These are difficult to weigh by a kitchen scale. Even in such instances, measure the amount accurately by scooping the ingredient in the measuring cup or the spoon of the desired size until the measure is more than full. Level the top with the straight edge of a metal spatula to remove the excess. Do not tap the bottom of the cup or spoon on the table to hold another scoop.

Correct way to use
a measuring cup.
(Use provided measuring cup.)

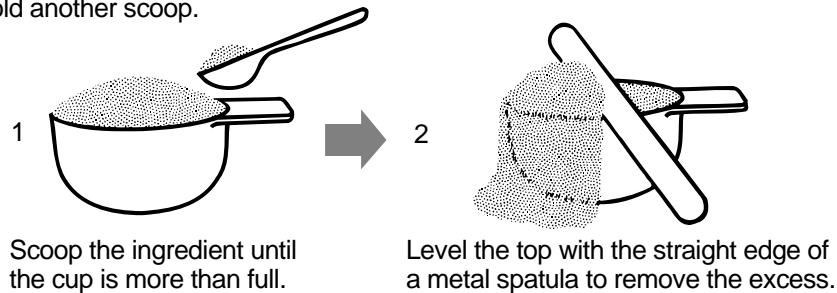

✂ Always use fresh ingredients.

Check the date on the package before purchasing and use the ingredients before they become outdated. After opening the package, store in the refrigerator. Yeast should always be kept in the refrigerator regardless of whether or not its package is opened. Flour should be kept in a cool, dry place (below 68°F). If such a place is not available, store it in the refrigerator.

Yeast is one of the ingredients whereby you cannot determine its freshness through visual inspection. A quick way to check its life is to pour a teaspoon of yeast in a 1/4 cup of warm water of 105°F to 115°F with a teaspoon of sugar. Set aside for a few minutes. The yeast is dead or is not activating if foam does not cover the surface of water as the result of fermentation. In such cases, *do not use the yeast packed in the same package, but open a fresh one.*

✂ Use the prescribed ingredients.

Ingredients other than those specified in the recipe should not be used. For further information on the ingredients read P.17 to P.19.

✂ Electrical fluctuations

Electrical fluctuations will affect the height, the texture and the color of bread. It is recommended that the unit is used where the electricity supply is constant.

Basic

BAKE & BAKE RAPID mode

For BAKE RAPID mode, add extra 1 tsp of dry yeast.

C=cup(s), tsp=teaspoon(s), TBSP=Tablespoon(s)

<Note for measuring flour>

The amounts shown in () are not as precise as weight measurements.

For better results, please use weight measurements. (1 cup = 4.92 oz.)

Basic White Bread

	XL		L		M	
	C/TBSP/tsp	oz./fl.oz.	C/TBSP/tsp	oz./fl.oz.	C/TBSP/tsp	oz./fl.oz.
Bread flour	(4 ⁷ / ₁₆ C)	21 ³ / ₄ oz.	(3 ¹¹ / ₁₆ C)	18 ¹ / ₄ oz.	(3 C)	14 ³ / ₄ oz.
Salt	2 tsp		2 tsp		1 ¹ / ₂ tsp	
Dry milk	2 TBSP		2 TBSP		1 ¹ / ₂ TBSP	
Butter	2 ¹ / ₂ TBSP		2 TBSP		1 ¹ / ₂ TBSP	
Sugar	2 TBSP		1 ³ / ₄ TBSP		1 ¹ / ₂ TBSP	
Water	1 ³ / ₄ C	14 fl.oz.	1 ¹ / ₂ C	12 ¹ / ₄ fl.oz.	1 ¹ / ₄ C	10 fl.oz.
Dry yeast	1 ¹ / ₂ tsp		1 ¹ / ₄ tsp		1 tsp	

() : measurements not as precise as weight measurements.

Carrot Spice Bread

	XL		L		M	
	C/TBSP/tsp	oz./fl.oz.	C/TBSP/tsp	oz./fl.oz.	C/TBSP/tsp	oz./fl.oz.
Bread flour	(4 ⁷ / ₁₆ C)	21 ³ / ₄ oz.	(3 ¹¹ / ₁₆ C)	18 ¹ / ₄ oz.	(3 C)	14 ³ / ₄ oz.
Salt	2 tsp		2 tsp		1 ¹ / ₂ tsp	
Dry milk	2 TBSP		2 TBSP		1 ¹ / ₂ TBSP	
Butter	2 ¹ / ₂ TBSP		2 TBSP		1 ¹ / ₂ TBSP	
Carrots, grated	1/4 C		2 ¹ / ₂ TBSP		2 TBSP	
Allspice	4 tsp		1 TBSP		2 tsp	
Honey	2 TBSP		2 TBSP		1 ¹ / ₂ TBSP	
Water	1 ¹ / ₂ C	12 ¹ / ₄ fl.oz.	1 ⁷ / ₁₆ C	11 ¹ / ₄ fl.oz.	1 ¹ / ₈ C	9 fl.oz.
Dry yeast	1 ¹ / ₂ tsp		1 ¹ / ₄ tsp		1 tsp	

() : measurements not as precise as weight measurements.

Cranberry Bread

	XL		L		M	
	C/TBSP/tsp	oz./fl.oz.	C/TBSP/tsp	oz./fl.oz.	C/TBSP/tsp	oz./fl.oz.
Bread flour	(4 ⁷ / ₁₆ C)	21 ³ / ₄ oz.	(3 ¹¹ / ₁₆ C)	18 ¹ / ₄ oz.	(3 C)	14 ³ / ₄ oz.
Salt	2 tsp		2 tsp		1 ¹ / ₂ tsp	
Dry milk	2 TBSP		2 TBSP		1 ¹ / ₂ TBSP	
Butter	2 ¹ / ₂ TBSP		2 TBSP		1 ¹ / ₂ TBSP	
Sugar	2 TBSP		1 ³ / ₄ TBSP		1 ¹ / ₂ TBSP	
Cranberry juice	3/4 C	6 fl.oz.	5/8 C	5 fl.oz.	1/2 C	4 fl.oz.
Water	1 C	8 fl.oz.	15/16 C	7 ¹ / ₄ fl.oz.	3/4 C	6 fl.oz.
Dry yeast	1 ¹ / ₂ tsp		1 ¹ / ₄ tsp		1 tsp	

() : measurements not as precise as weight measurements.

Egg Bread

	XL		L		M	
	C/TBSP/tsp	oz./fl.oz.	C/TBSP/tsp	oz./fl.oz.	C/TBSP/tsp	oz./fl.oz.
Bread flour	(4 ⁷ / ₁₆ C)	21 ³ / ₄ oz.	(3 ¹¹ / ₁₆ C)	18 ¹ / ₄ oz.	(3 C)	14 ³ / ₄ oz.
Salt	2 tsp		2 tsp		1 ¹ / ₂ tsp	
Dry milk	2 TBSP		2 TBSP		1 ¹ / ₂ TBSP	
Butter	2 ¹ / ₂ TBSP		2 TBSP		1 ¹ / ₂ TBSP	
Sugar	2 TBSP		1 ³ / ₄ TBSP		1 ¹ / ₂ TBSP	
Egg	2		2		1	
Milk with the egg*	1 ³ / ₄ C	14 fl.oz.	1 ¹ / ₂ C	12 ¹ / ₄ fl.oz.	1 ¹ / ₄ C	10 fl.oz.
Dry yeast	1 ¹ / ₂ tsp		1 ¹ / ₄ tsp		1 tsp	

*Place the egg (s) in the measuring cup, then add milk. () : measurements not as precise as weight measurements.

Herb Bread

	XL		L		M	
	C/TBSP/tsp	oz./fl.oz.	C/TBSP/tsp	oz./fl.oz.	C/TBSP/tsp	oz./fl.oz.
Bread flour	(4 ⁷ / ₁₆ C)	21 ³ / ₄ oz.	(3 ¹¹ / ₁₆ C)	18 ¹ / ₄ oz.	(3 C)	14 ³ / ₄ oz.
Salt	2 tsp		2 tsp		1 ¹ / ₂ tsp	
Dry milk	2 TBSP		2 TBSP		1 ¹ / ₂ TBSP	
Butter	2 ¹ / ₂ TBSP		2 TBSP		1 ¹ / ₂ TBSP	
Dry parsley	1/4 C		3 TBSP		2 TBSP	
Caraway seeds	3 TBSP		2 TBSP		1 TBSP	
Dill seeds	3 TBSP		2 TBSP		1 TBSP	
Water	1 ⁷ / ₈ C	15 fl.oz.	1 ⁷ / ₁₆ C	11 ¹ / ₄ fl.oz.	1 ¹ / ₈ C	9 fl.oz.
Dry yeast	1 ¹ / ₂ tsp		1 ¹ / ₄ tsp		1 tsp	

() : measurements not as precise as weight measurements.

BAKE & BAKE RAPID mode

For BAKE RAPID mode, add extra 1 tsp of dry yeast.

C=cup(s), tsp=teaspoon(s), TBSP=Tablespoon(s)

<Note for measuring flour>

The amounts shown in () are not as precise as weight measurements.

For better results, please use weight measurements. (1 cup = 4.92 oz.)

Basic**Milk Bread**

	XL		L		M	
	C/TBSP/tsp	oz./fl.oz.	C/TBSP/tsp	oz./fl.oz.	C/TBSP/tsp	oz./fl.oz.
Bread flour	(4 ⁷ / ₁₆ C)	21 ³ / ₄ oz.	(3 ¹¹ / ₁₆ C)	18 ¹ / ₄ oz.	(3 C)	14 ³ / ₄ oz.
Salt	2 tsp		2 tsp		1 ¹ / ₂ tsp	
Dry milk	2 TBSP		2 TBSP		1 ¹ / ₂ TBSP	
Butter	2 ¹ / ₂ TBSP		2 TBSP		1 ¹ / ₂ TBSP	
Sugar	2 TBSP		1 ³ / ₄ TBSP		1 ¹ / ₂ TBSP	
Milk	1 ¹³ / ₁₆ C	14 ¹ / ₂ fl.oz.	1 ¹ / ₂ C	12 ¹ / ₄ fl.oz.	1 ¹ / ₄ C	10 fl.oz.
Dry yeast	1 ¹ / ₂ tsp		1 ¹ / ₄ tsp		1 tsp	

Pepperoni & Cheese Bread

() : measurements not as precise as weight measurements.

	XL		L		M	
	C/TBSP/tsp	oz./fl.oz.	C/TBSP/tsp	oz./fl.oz.	C/TBSP/tsp	oz./fl.oz.
Bread flour	(4 ⁷ / ₁₆ C)	21 ³ / ₄ oz.	(3 ¹¹ / ₁₆ C)	18 ¹ / ₄ oz.	(3 C)	14 ³ / ₄ oz.
Salt	2 tsp		2 tsp		1 ¹ / ₂ tsp	
Dry milk	2 TBSP		2 TBSP		1 ¹ / ₂ TBSP	
Sugar	2 TBSP		1 ³ / ₄ TBSP		1 ¹ / ₂ TBSP	
Pepperoni, finely chopped		4 oz.		3 oz.		2 oz.
Provolone cheese, chopped	³ / ₈ C		¹ / ₄ C		¹ / ₈ C	
Parmesan cheese, grated	³ / ₁₆ C		¹ / ₈ C		¹ / ₁₆ C	
Garlic powder	¹ / ₂ tsp		¹ / ₂ tsp		¹ / ₄ tsp	
Onion powder	¹ / ₂ tsp		¹ / ₂ tsp		¹ / ₄ tsp	
Oregano	¹ / ₄ tsp		¹ / ₄ tsp		¹ / ₄ tsp	
Olive oil	1 TBSP		2 tsp		1 tsp	
Water	1 ⁵ / ₈ C	13 fl.oz.	1 ⁷ / ₁₆ C	11 ¹ / ₂ fl.oz.	1 ³ / ₁₆ C	9 ¹ / ₂ fl.oz.
Dry yeast	1 ¹ / ₂ tsp		1 ¹ / ₄ tsp		1 tsp	

Rye Bread with Onions and Caraway

() : measurements not as precise as weight measurements.

	XL		L		M	
	C/TBSP/tsp	oz./fl.oz.	C/TBSP/tsp	oz./fl.oz.	C/TBSP/tsp	oz./fl.oz.
Bread flour	(4 ⁷ / ₁₆ C)	21 ³ / ₄ oz.	(3 ¹ / ₁₆ C)	18 ¹ / ₄ oz.	(3 C)	14 ³ / ₄ oz.
Rye flour	¹ / ₄ C		³ / ₁₆ C		¹ / ₈ C	
Salt	2 tsp		2 tsp		1 ¹ / ₂ tsp	
Dry milk	2 TBSP		2 TBSP		1 ¹ / ₂ TBSP	
Sugar	2 TBSP		1 ³ / ₄ TBSP		1 ¹ / ₂ TBSP	
Butter	2 ¹ / ₂ TBSP		2 TBSP		1 ¹ / ₂ TBSP	
Onions, chopped	³ / ₈ C		¹ / ₄ C		¹ / ₈ C	
Caraway seeds	1 ¹ / ₂ TBSP		1 TBSP		2 tsp	
Water	1 ¹ / ₂ C	12 ¹ / ₄ fl.oz.	1 ³ / ₈ C	11 fl.oz.	1 ³ / ₁₆ C	9 ¹ / ₂ fl.oz.
Dry yeast	1 ¹ / ₂ tsp		1 ¹ / ₄ tsp		1 tsp	

Spicy Cheese

() : measurements not as precise as weight measurements.

	XL		L		M	
	C/TBSP/tsp	oz./fl.oz.	C/TBSP/tsp	oz./fl.oz.	C/TBSP/tsp	oz./fl.oz.
Bread flour	(4 ⁷ / ₁₆ C)	21 ³ / ₄ oz.	(3 ¹ / ₁₆ C)	18 ¹ / ₄ oz.	(3 C)	14 ³ / ₄ oz.
Salt	2 tsp		2 tsp		1 ¹ / ₂ tsp	
Dry milk	2 TBSP		2 TBSP		1 ¹ / ₂ TBSP	
Sugar	2 TBSP		1 ³ / ₄ TBSP		1 ¹ / ₂ TBSP	
Dry mustard	2 tsp		1 ¹ / ₂ tsp		1 tsp	
Black pepper	¹ / ₂ tsp		¹ / ₂ tsp		¹ / ₄ tsp	
Butter	2 ¹ / ₂ TBSP		2 TBSP		1 ¹ / ₂ TBSP	
Cheddar cheese, shredded	³ / ₈ C		¹ / ₄ C		³ / ₁₆ C	
Worcester sauce	2 TBSP		1 ¹ / ₂ TBSP		1 TBSP	
Water	1 ⁷ / ₈ C	15 fl.oz.	1 ⁹ / ₁₆ C	12 ¹ / ₂ fl.oz.	1 ⁵ / ₁₆ C	10 ¹ / ₂ fl.oz.
Dry yeast	1 ¹ / ₂ tsp		1 ¹ / ₄ tsp		1 tsp	

Zucchini

() : measurements not as precise as weight measurements.

	XL		L		M	
	C/TBSP/tsp	oz./fl.oz.	C/TBSP/tsp	oz./fl.oz.	C/TBSP/tsp	oz./fl.oz.
Bread flour	(4 ⁷ / ₁₆ C)	21 ³ / ₄ oz.	(3 ¹ / ₁₆ C)	18 ¹ / ₄ oz.	(3 C)	14 ³ / ₄ oz.
Salt	2 tsp		2 tsp		1 ¹ / ₂ tsp	
Dry milk	2 TBSP		2 TBSP		1 ¹ / ₂ TBSP	
Sugar	2 TBSP		1 ³ / ₄ TBSP		1 ¹ / ₂ TBSP	
Cinnamon	2 tsp		1 ¹ / ₂ tsp		1 tsp	
Cloves, Powdered	1 tsp		¹ / ₂ tsp		¹ / ₄ tsp	
Butter	2 ¹ / ₂ TBSP		2 TBSP		1 ¹ / ₂ TBSP	
Walnuts, finely chopped	⁵ / ₁₆ C		¹ / ₄ C		³ / ₁₆ C	
Zucchini, grated	⁵ / ₁₆ C		¹ / ₄ C		³ / ₁₆ C	
Water	1 ¹ / ₂ C	12 fl.oz.	1 ⁵ / ₁₆ C	10 ¹ / ₂ fl.oz.	1 ¹ / ₁₆ C	8 ³ / ₄ fl.oz.
Dry yeast	1 ¹ / ₂ tsp		1 ¹ / ₄ tsp		1 tsp	

() : measurements not as precise as weight measurements.

Basic Raisin

Select BAKE RAISIN mode

C=cup(s), tsp=teaspoon(s), TBSP=Tablespoon(s)

Ingredients in *italics* should be added at the beep.

<Note for measuring flour>

The amounts shown in () are not as precise as weight measurements.

For better results, please use weight measurements. (1 cup = 4.92 oz.)

Basic Raisin

	XL		L		M	
	C/TBSP/tsp	oz./fl.oz.	C/TBSP/tsp	oz./fl.oz.	C/TBSP/tsp	oz./fl.oz.
Bread flour	(4 ⁷ / ₁₆ C)	21 ³ / ₄ oz.	(3 ¹¹ / ₁₆ C)	18 ¹ / ₄ oz.	(3 C)	14 ³ / ₄ oz.
Salt	2 tsp		2 tsp		1 ¹ / ₂ tsp	
Dry milk	2 TBSP		2 TBSP		1 ¹ / ₂ TBSP	
Butter	2 ¹ / ₂ TBSP		2 TBSP		1 ¹ / ₂ TBSP	
Sugar	2 TBSP		1 ³ / ₄ TBSP		1 ¹ / ₂ TBSP	
Water	1 ³ / ₄ C	14 fl.oz.	1 ¹ / ₂ C	12 ¹ / ₄ fl.oz.	1 ¹ / ₄ C	10 fl.oz.
Dry yeast	1 ¹ / ₂ tsp		1 ¹ / ₄ tsp		1 tsp	
<i>Raisins</i>		4.4 oz.		3 ¹ / ₂ oz.		3 oz.

() : measurements not as precise as weight measurements.

*If you find that the raisins do not get mixed into the dough but remain burnt on the surface of the loaf, which then come off after being baked, increase 1—2 tablespoons of water to make the dough softer the next time.

Fruit Nut Bran

	XL		L		M	
	C/TBSP/tsp	oz./fl.oz.	C/TBSP/tsp	oz./fl.oz.	C/TBSP/tsp	oz./fl.oz.
Bread flour	(4 ⁷ / ₁₆ C)	21 ³ / ₄ oz.	(3 ¹¹ / ₁₆ C)	18 ¹ / ₄ oz.	(3 C)	14 ³ / ₄ oz.
Salt	2 tsp		2 tsp		1 ¹ / ₂ tsp	
Dry milk	2 TBSP		2 TBSP		1 ¹ / ₂ TBSP	
Butter	2 ¹ / ₂ TBSP		2 TBSP		1 ¹ / ₂ TBSP	
Sugar	2 TBSP		1 ³ / ₄ TBSP		1 ¹ / ₂ TBSP	
Bran flakes	1 ¹ / ₄ C		1 ¹ / ₄ C		1 ¹ / ₈ C	
Sliced almonds	3 ³ / ₈ C		5 ⁵ / ₁₆ C		1 ¹ / ₄ C	
Water	1 ³ / ₄ C	14 fl.oz.	1 ¹ / ₂ C	12 ¹ / ₄ fl.oz.	1 ¹ / ₄ C	10 fl.oz.
Dry yeast	1 ¹ / ₂ tsp		1 ¹ / ₄ tsp		1 tsp	
<i>Dried fruit bits</i>		3 ¹ / ₂ oz.		3 oz.		2 oz.

() : measurements not as precise as weight measurements.

Basic Sandwich

Select BAKE SANDWICH mode

C=cup(s), tsp=teaspoon(s), TBSP=Tablespoon(s)

These loaves are all one size. Size selection cannot be made.

<Note for measuring flour>

The amounts shown in () are not as precise as weight measurements.

For better results, please use weight measurements. (1 cup = 4.92 oz.)

Basic Sandwich

	C/TBSP/tsp	oz./fl.oz.
Bread flour	(3 C)	14 ³ / ₄ oz.
Salt	1 ¹ / ₂ tsp	
Dry milk	1 ¹ / ₂ TBSP	
Butter	1 ¹ / ₂ TBSP	
Sugar	1 ¹ / ₂ TBSP	
Water	1 ¹ / ₄ C	10 fl.oz.
Dry yeast	1 tsp	

() : measurements not as precise as weight measurements.

Walnut Cinnamon

	C/TBSP/tsp	oz./fl.oz.
Bread flour	(3 C)	14 ³ / ₄ oz.
Salt	1 ¹ / ₂ tsp	
Dry milk	1 ¹ / ₂ TBSP	
Butter	1 ¹ / ₂ TBSP	
Brown sugar	1 ¹ / ₂ TBSP	
Cinnamon	1 tsp	
Walnuts	3 ³ / ₁₆ C	
Water	1 ¹ / ₄ C	10 fl.oz.
Dry yeast	1 tsp	

() : measurements not as precise as weight measurements.

BAKE & BAKE RAPID mode

For BAKERAPID mode, add extra 1 tsp of dry yeast

C=cup(s), tsp=teaspoon(s), TBSP=Tablespoon(s)

The amounts shown in () are not as precise as weight measurements.

For better results, please use weight measurements. (1 cup = 4.92 oz.)

Whole Wheat**100% Whole Wheat**

	XL		L		M	
	C/TBSP/tsp	oz./fl.oz.	C/TBSP/tsp	oz./fl.oz.	C/TBSP/tsp	oz./fl.oz.
Whole wheat flour	(4 ⁵ / ₁₆ C)	21 ³ / ₁₆ oz.	(3 ¹¹ / ₁₆ C)	18 ¹ / ₄ oz.	(3 C)	14 ³ / ₄ oz.
Salt	2 tsp		2 tsp		1 ¹ / ₂ tsp	
Dry milk	2 TBSP		2 TBSP		1 ¹ / ₂ TBSP	
Butter	2 ¹ / ₂ TBSP		2 TBSP		1 ¹ / ₂ TBSP	
Molasses	2 TBSP		1 ³ / ₄ TBSP		1 ¹ / ₂ TBSP	
Water	1 ³ / ₄ C	14 fl.oz.	1 ¹ / ₂ C	12 ¹ / ₄ fl.oz.	1 ¹ / ₄ C	10 fl.oz.
Dry yeast	1 ¹ / ₂ tsp		1 ¹ / ₄ tsp		1 tsp	

() : measurements not as precise as weight measurements.

Honey Walnut

	XL		L		M	
	C/TBSP/tsp	oz./fl.oz.	C/TBSP/tsp	oz./fl.oz.	C/TBSP/tsp	oz./fl.oz.
Whole wheat flour	(4 ⁵ / ₁₆ C)	21 ³ / ₁₆ oz.	(3 ¹¹ / ₁₆ C)	18 ¹ / ₄ oz.	(3 C)	14 ³ / ₄ oz.
Salt	2 tsp		2 tsp		1 ¹ / ₂ tsp	
Dry milk	2 TBSP		2 TBSP		1 ¹ / ₂ TBSP	
Butter	2 ¹ / ₂ TBSP		2 TBSP		1 ¹ / ₂ TBSP	
Walnuts, finely chopped	1 ¹ / ₂ C	1 ³ / ₄	3 ³ / ₈ C	1 ¹ / ₂ oz.	1 ¹ / ₄ C	1 ¹ / ₄ oz.
Honey	2 TBSP		1 ³ / ₄ TBSP		1 ¹ / ₂ TBSP	
Water	1 ³ / ₄ C	14 fl.oz.	1 ¹ / ₂ C	12 ¹ / ₄ fl.oz.	1 ¹ / ₄ C	10 fl.oz.
Dry yeast	1 ¹ / ₂ tsp		1 ¹ / ₄ tsp		1 tsp	

() : measurements not as precise as weight measurements.

Nut Bran

	XL		L		M	
	C/TBSP/tsp	oz./fl.oz.	C/TBSP/tsp	oz./fl.oz.	C/TBSP/tsp	oz./fl.oz.
Whole wheat flour	(2 ¹ / ₈ C)	10 ¹ / ₂ oz.	(1 ⁷ / ₈ C)	9 ¹ / ₈ oz.	(1 ¹ / ₂ C)	7 ³ / ₈ oz.
Bread flour	(2 ¹ / ₈ C)	10 ¹ / ₂ oz.	(1 ⁷ / ₈ C)	9 ¹ / ₈ oz.	(1 ¹ / ₂ C)	7 ³ / ₈ oz.
Salt	2 tsp		2 tsp		1 ¹ / ₂ tsp	
Dry milk	2 TBSP		2 TBSP		1 ¹ / ₂ TBSP	
Almond slices	1 ¹ / ₂ C		3 ³ / ₈ C		1 ¹ / ₄ C	
Bran flakes	1 ¹ / ₂ C		3 ³ / ₈ C		1 ¹ / ₄ C	
Honey	2 TBSP		1 ³ / ₄ TBSP		1 ¹ / ₂ TBSP	
Water	1 ³ / ₄ C	14 fl.oz.	1 ¹ / ₂ C	12 ¹ / ₄ fl.oz.	1 ¹ / ₄ C	10 fl.oz.
Dry yeast	1 ¹ / ₂ tsp		1 ¹ / ₄ tsp		1 tsp	

() : measurements not as precise as weight measurements.

Peanut Sesame

	XL		L		M	
	C/TBSP/tsp	oz./fl.oz.	C/TBSP/tsp	oz./fl.oz.	C/TBSP/tsp	oz./fl.oz.
Whole wheat flour	(2 ¹ / ₈ C)	10 ¹ / ₂ oz.	(1 ⁷ / ₈ C)	9 ¹ / ₈ oz.	(1 ¹ / ₂ C)	7 ³ / ₈ oz.
Bread flour	(2 ¹ / ₈ C)	10 ¹ / ₂ oz.	(1 ⁷ / ₈ C)	9 ¹ / ₈ oz.	(1 ¹ / ₂ C)	7 ³ / ₈ oz.
Salt	2 tsp		2 tsp		1 ¹ / ₂ tsp	
Dry milk	2 TBSP		2 TBSP		1 ¹ / ₂ TBSP	
Peanut butter	1 ¹ / ₄ C	2 ¹ / ₄ oz.	3 ³ / ₁₆ C	2 oz.	1 ¹ / ₈ C	1 ¹ / ₂ oz.
Brown sugar	2 TBSP		1 ¹ / ₂ TBSP		1 TBSP	
Sesame seeds	3 ³ / ₈ C		1 ¹ / ₄ C		1 ¹ / ₈ C	
Water	1 ¹³ / ₁₆ C	14 ¹ / ₂ fl.oz.	1 ⁹ / ₁₆ C	12 ¹¹ / ₂ fl.oz.	1 ¹ / ₄ C	10 fl.oz.
Dry yeast	1 ¹ / ₂ tsp		1 ¹ / ₄ tsp		1 tsp	

() : measurements not as precise as weight measurements.

Whole Wheat Yogurt

	XL		L		M	
	C/TBSP/tsp	oz./fl.oz.	C/TBSP/tsp	oz./fl.oz.	C/TBSP/tsp	oz./fl.oz.
Whole wheat flour	(4 ⁵ / ₁₆ C)	21 ³ / ₁₆ oz.	(3 ¹¹ / ₁₆ C)	18 ¹ / ₄ oz.	(3 C)	14 ³ / ₄ oz.
Salt	2 tsp		2 tsp		1 ¹ / ₂ tsp	
Dry milk	2 TBSP		2 TBSP		1 ¹ / ₂ TBSP	
Butter	2 ¹ / ₂ TBSP		2 TBSP		1 ¹ / ₂ TBSP	
Brown sugar	2 TBSP		1 ¹ / ₂ TBSP		1 TBSP	
Sesame seeds	3 ³ / ₈ C		1 ¹ / ₄ C		1 ¹ / ₈ C	
Yogurt (plain)	1 C		3 ³ / ₄ C		1 ¹ / ₂ C	
Water	1 ⁵ / ₁₆ C	7 ¹ / ₂ fl.oz.	7 ⁷ / ₈ C	7 fl.oz.	1 ¹³ / ₁₆ C	6 ¹ / ₂ fl.oz.
Dry yeast	1 ¹ / ₂ tsp		1 ¹ / ₄ tsp		1 tsp	

() : measurements not as precise as weight measurements.

Whole Wheat Raisin

Select BAKE RAISIN mode

C=cup(s), tsp=teaspoon(s), TBSP=Tablespoon(s)

Ingredients in *italics> should be added at the beep.*

<Note for measuring flour>

The amounts shown in () are not as precise as weight measurements.

For better results, please use weight measurements. (1 cup = 4.92 oz.)

Whole Wheat Raisin

	XL		L		M	
	C/TBSP/tsp	oz./fl.oz.	C/TBSP/tsp	oz./fl.oz.	C/TBSP/tsp	oz./fl.oz.
Whole wheat flour	(4 ¹ / ₄ C)	21 oz.	(3 ¹¹ / ₁₆ C)	18 ¹ / ₄ oz.	(3 C)	14 ³ / ₄ oz.
Salt	2 tsp		2 tsp		1 ¹ / ₂ tsp	
Dry milk	2 TBSP		2 TBSP		1 ¹ / ₂ TBSP	
Butter	2 ¹ / ₂ TBSP		2 TBSP		1 ¹ / ₂ TBSP	
Molasses	2 TBSP		1 ³ / ₄ TBSP		1 ¹ / ₂ TBSP	
Water	1 ⁷ / ₈ C	15 fl.oz.	1 ⁵ / ₈ C	13 fl.oz.	1 ⁵ / ₁₆ C	10 ³ / ₄ fl.oz.
Dry yeast	1 ¹ / ₂ tsp		1 ¹ / ₄ tsp		1 tsp	
<i>Raisins</i>		4.4 oz.		3 ¹ / ₂ oz.		3 oz.

() : measurements not as precise as weight measurements.

*If you find that the raisins do not get mixed into the dough but remain burnt on the surface of the loaf, which then come off after being baked, increase 1—2 tablespoons of water to make the dough softer the next time.

Apple Raisin

	XL		L		M	
	C/TBSP/tsp	oz./fl.oz.	C/TBSP/tsp	oz./fl.oz.	C/TBSP/tsp	oz./fl.oz.
Basic flour	(2 ¹ / ₈ C)	10 ¹ / ₂ oz.	(1 ¹³ / ₁₆ C)	9 oz.	(1 ¹ / ₂ C)	7 ¹ / ₃ oz.
Whole wheat flour	(2 ¹ / ₈ C)	10 ¹ / ₂ oz.	(1 ¹³ / ₁₆ C)	9 oz.	(1 ¹ / ₂ C)	7 ¹ / ₃ oz.
Salt	2 tsp		2 tsp		1 ¹ / ₂ tsp	
Dry milk	2 TBSP		2 TBSP		1 ¹ / ₂ TBSP	
Butter	2 ¹ / ₂ TBSP		2 TBSP		1 ¹ / ₂ TBSP	
Sugar	1 ¹ / ₂ TBSP		1 TBSP		2 tsp	
Cinammon	2 tsp		1 ¹ / ₂ tsp		1 tsp	
Apple, grated	1 ¹ / ₂ C	3 ³ / ₄ oz.	3 ³ / ₈ C	3 oz.	1 ¹ / ₄ C	1 ³ / ₄ oz.
Water	1 ³ / ₈ C	11 fl.oz.	1 ¹ / ₄ C	10 fl.oz.	1 ¹ / ₁₆ C	8 ¹ / ₂ fl.oz.
Dry yeast	1 ¹ / ₂ tsp		1 ¹ / ₄ tsp		1 tsp	
<i>Raisins</i>		4.4 oz.		3 ¹ / ₂ oz.		3 oz.

() : measurements not as precise as weight measurements.

Orange Anise

	XL		L		M	
	C/TBSP/tsp	oz./fl.oz.	C/TBSP/tsp	oz./fl.oz.	C/TBSP/tsp	oz./fl.oz.
Basic flour	(2 ¹ / ₈ C)	10 ¹ / ₂ oz.	(1 ¹³ / ₁₆ C)	9 oz.	(1 ¹ / ₂ C)	7 ¹ / ₃ oz.
Whole wheat flour	(2 ¹ / ₈ C)	10 ¹ / ₂ oz.	(1 ¹³ / ₁₆ C)	9 oz.	(1 ¹ / ₂ C)	7 ¹ / ₃ oz.
Salt	2 tsp		2 tsp		1 ¹ / ₂ tsp	
Dry milk	2 TBSP		2 TBSP		1 ¹ / ₂ TBSP	
Butter	2 ¹ / ₂ TBSP		2 TBSP		1 ¹ / ₂ TBSP	
Brown sugar	2 TBSP		1 ¹ / ₂ TBSP		1 TBSP	
Anise	3 tsp		2 tsp		1 tsp	
Orange juice	3 ³ / ₄ C	6 fl.oz	5 ⁵ / ₈ C	5 fl.oz	1 ¹ / ₂ C	4 fl.oz
Water	1 C	8 fl.oz	1 ⁵ / ₁₆ C	7 ¹ / ₄ fl.oz	3 ³ / ₄ C	6 fl.oz
Dry yeast	1 ¹ / ₂ tsp		1 ¹ / ₄ tsp		1 tsp	
<i>Orange zest, chopped</i>	3 ³ / ₈ C		1 ¹ / ₄ C		2 TBSP	

() : measurements not as precise as weight measurements.

Whole Wheat Sandwich

Select BAKE SANDWICH mode

C=cup(s), tsp=teaspoon(s), TBSP=Tablespoon(s)

These loaves are all one size. Size selection cannot be made.

<Note for measuring flour>

The amounts shown in () are not as precise as weight measurements.

For better results, please use weight measurements. (1 cup = 4.92 oz.)

Whole Wheat Sandwich

	C/TBSP/tsp	oz./fl.oz.
Whole wheat flour	(3 C)	14 ³ / ₄ oz.
Salt	1 ¹ / ₂ tsp	
Dry milk	1 ¹ / ₂ TBSP	
Butter	1 ¹ / ₂ TBSP	
Molasses	1 ¹ / ₂ TBSP	
Water	1 ¹ / ₄ C	10 fl.oz.
Dry yeast	1 ¹ / ₄ tsp	

() : measurements not as precise as weight measurements.

Whole Wheat Herb

	C/TBSP/tsp	oz./fl.oz.
Whole wheat flour	(3 C)	14 ³ / ₄ oz.
Salt	1 ¹ / ₂ tsp	
Dry milk	1 ¹ / ₂ TBSP	
Butter	1 ¹ / ₂ TBSP	
Brown sugar	1 ¹ / ₂ TBSP	
Basil flakes	1 TBSP	
Parsley flakes	1 TBSP	
Garlic powder	1 ¹ / ₂ tsp	
Water	1 ¹ / ₄ C	10 fl.oz.
Dry yeast	1 ¹ / ₄ tsp	

() : measurements not as precise as weight measurements.

Select BAKE mode

C=cup(s), tsp=teaspoon(s), TBSP=Tablespoon(s)

These loaves are all one size. Size selection cannot be made.

<Note for measuring flour>

The amounts shown in () are not as precise as weight measurements.

For better results, please use weight measurements. (1 cup = 4.92 oz.)

Multigrain

Anadama

	C/TBSP/tsp	oz./fl.oz.
Whole wheat flour	(3 ³ / ₄ C)	18 ² / ₃ oz.
Salt	2 tsp	
Dry milk	2 TBSP	
Butter	2 ¹ / ₂ TBSP	
Cornmeal	¹ / ₄ C	
Molasses	2 TBSP	
Water		13 ¹ / ₂ fl.oz.
Dry yeast	1 ¹ / ₂ tsp	

() : measurements not as precise as weight measurements.

Cracked Wheat Sunflower

	C/TBSP/tsp	oz./fl.oz.
Whole wheat flour	(3 ³ / ₄ C)	18 ² / ₃ oz.
Salt	2 tsp	
Dry milk	2 TBSP	
Butter	2 ¹ / ₂ TBSP	
Brown sugar	2 TBSP	
Cracked wheat cereal	¹ / ₄ C	
Unsalted sunflower seeds	¹ / ₄ C	
Honey	2 TBSP	
Water		13 ¹ / ₂ fl.oz.
Dry yeast	1 ¹ / ₂ tsp	

() : measurements not as precise as weight measurements.

Ancient

	C/TBSP/tsp	oz./fl.oz.
Whole wheat flour	(3 ³ / ₄ C)	18 ² / ₃ oz.
Salt	2 tsp	
Dry milk	2 TBSP	
Butter	2 ¹ / ₂ TBSP	
Brown sugar	3 TBSP	
Amaranth grains	2 TBSP	
Quinoa grains	2 TBSP	
Water		13 ¹ / ₂ fl.oz.
Dry yeast	1 ¹ / ₂ tsp	

() : measurements not as precise as weight measurements.

Multigrain

	C/TBSP/tsp	oz./fl.oz.
Whole wheat flour	(1 ³ / ₄ C)	8 ¹ / ₂ oz.
Bread flour	(2 C)	10 oz.
Soy flour	2 TBSP	
Cornmeal	2 TBSP	
Cracked wheat cereal	2 TBSP	
Oatmeal	1 TBSP	
Flax seeds	1 TBSP	
Salt	2 tsp	
Dry milk	2 TBSP	
Butter	2 ¹ / ₂ TBSP	
Molasses	2 TBSP	
Water		13 ¹ / ₂ fl.oz.
Dry yeast	1 ¹ / ₂ tsp	

() : measurements not as precise as weight measurements.

Bran & Sesame

	C/TBSP/tsp	oz./fl.oz.
Whole wheat flour	(3 ³ / ₄ C)	18 ² / ₃ oz.
Salt	2 tsp	
Dry milk	2 TBSP	
Butter	2 ¹ / ₂ TBSP	
Brown sugar	2 TBSP	
Sesame seeds	¹ / ₄ C	
Wheat bran cereal	¹ / ₄ C	¹ / ₂ oz.
Water		13 ¹ / ₂ fl.oz.
Dry yeast	1 ¹ / ₂ tsp	

() : measurements not as precise as weight measurements.

Seven Grain

	C/TBSP/tsp	oz./fl.oz.
Whole wheat flour	(3 ³ / ₄ C)	18 ² / ₃ oz.
Salt	2 tsp	
Dry milk	2 TBSP	
Butter	2 ¹ / ₂ TBSP	
7—grain cereal	³ / ₈ C	
Molasses	2 TBSP	
Water		13 ¹ / ₂ fl.oz.
Dry yeast	1 ¹ / ₂ tsp	

() : measurements not as precise as weight measurements.

Select **BAKE** mode

C=cup(s), tsp=teaspoon(s), TBSP=Tablespoon(s)
This loaf is one size. Size selection cannot be made.
 <Note for measuring flour>
 The amounts shown in () are not as precise as weight measurements.
 For better results, please use weight measurements.
 (1 cup = 4.92 oz.)

French Bread

	C/TBSP/tsp	oz./fl.oz.
Bread flour	(3 C)	14 ³ / ₄ oz.
Salt	1 ¹ / ₂ tsp	
Butter	1 TBSP	
Water		10 ¹ / ₂ fl.oz.
Dry yeast	1 tsp	

() : measurements not as precise as weight measurements.

Select **DOUGH** mode

C=cup(s), tsp=teaspoon(s), TBSP=Tablespoon(s)
This loaf is one size. Size selection cannot be made.
 <Note for measuring flour>
 The amounts shown in () are not as precise as weight measurements.
 For better results, please use weight measurements.
 (1 cup = 4.92 oz.)

Baguette (French sticks) (Yield 2)

	C/TBSP/tsp	oz./fl.oz.
Bread flour	(3 C)	14 ³ / ₄ oz.
sugar	1 TBSP	
Salt	1 ¹ / ₂ tsp	
Dry milk	1 TBSP	
Butter	2 TBSP	
Water		8 ³ / ₄ fl.oz.
Dry yeast	1 ¹ / ₂ tsp	
Poppy seeds, optional	3 TBSP	

() : measurements not as precise as weight measurements.

- 1** Make the dough according to instructions on P.7—9.
- 2** Divide the dough into 2 equal portions. Roll each portion into a ball.
- 3** Place the dough in a greased bowl. Cover. Rest for about 20 minutes. (Place in the refrigerator during the summer time.)
- 4** Roll each ball into a rectangle, using a rolling pin.
- 5** Starting at one short edge, roll the dough up tightly into a thin log, pinching the edges to seal. Taper and round ends.
- 6** Place on a greased baking pan. Spray water on top. Proof at 90°F for 60 minutes or until nearly doubled.
- 7** Brush with water. With a sharp knife, make 3 or 4 diagonal cuts about ¹/₄ inch deep across top of the logs.
- 8** Sprinkle with poppy seeds if desired.
- 9** Bake in 375°F oven for 25 to 30 minutes or until golden brown.
If your oven allows for steaming, bake with steam for first 10 minutes.

Select DOUGH mode

C=cup(s), tsp=teaspoon(s), TBSP=Tablespoon(s)

<Note for measuring flour>

The amounts shown in () are not as precise as weight measurements.

For better results, please use weight measurements. (1 cup = 4.92 oz.)

Dinner Rolls (Yield 18)

16 oz. (3 ¹ / ₄ C)	bread flour
1/4 C	sugar
1 ¹ / ₂ tsp	salt
3 TBSP	dry milk
3 TBSP	butter or margarine
7 ¹ / ₂ fl.oz. (15 ¹⁵ / ₁₆ C)	water
1 ¹ / ₂ tsp	dry yeast
1	egg, beaten for brushing on top
3/4 TBSP	poppy seeds, optional for sprinkling on top
3/4 TBSP	sesame seeds, optional for sprinkling on top

Variation: Whole Wheat Dinner Rolls
Replace 1¹/₂ cups bread flour with whole wheat flour.

() : measurements not as precise as weight measurements.

1 Make the dough according to instructions on P.7—9.

2 Divide the dough into 18 equal portions. Roll each portion into a ball. Cover with a plastic wrap and rest for 20 minutes.



3 Roll one end of the ball on a lightly floured surface to make a cone.



4 Roll each cone into a wedge shape, approximately 1/4 inch thick, using a rolling pin.



5 Starting with the wider end, roll up the wedge loosely towards the narrower end.



6 Place seam side down on a greased baking pan.



7 Spray water on top. Proof at 90°F for 30 to 50 minutes or until nearly doubled.



8 Brush rolls with beaten egg, sprinkle with poppy seeds or sesame seeds if desired.



9 Bake in 350°F oven for 10 to 15 minutes or until golden brown.



Select DOUGH mode

C=cup(s), tsp=teaspoon(s), TBSP=Tablespoon(s)

<Note for measuring flour>

The amounts shown in () are not as precise as weight measurements. For better results, please use weight measurements. (1 cup = 4.92 oz.)

Croissants (Yield 18)

16 oz. (3 ¹ / ₄ C)	bread flour
2 TBSP	sugar
3 TBSP	dry milk
1 ¹ / ₂ tsp	salt
8 fl.oz. (1 C)	water
2 TBSP	butter or margarine
2 tsp	dry yeast
7 oz.	butter or margarine, chilled for folding in the dough
1	egg, beaten for brushing on top

() : measurements not as precise as weight measurements.

1 Make the dough according to instructions on P.7—9.

2 Place the dough in a greased bowl. Cover. Rest the dough in the refrigerator for 30 minutes.

3 Roll 7 oz. of chilled butter between two sheets of waxed paper into a 10X7 inch rectangle. Place back in the refrigerator. Chill at least 1 hour.



4 Roll out the dough on a lightly floured surface into a 12 inch square.



5 Place the rolled out butter over two-thirds of the dough. Fold the third without butter over the center third.



6 Fold the remaining third on top. Seal edges. Rest the dough in the refrigerator for 20 to 30 minutes.

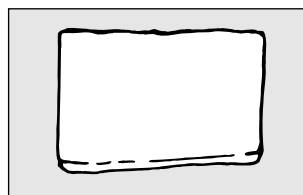

7 Place the dough at right angles to the previous position in #5. Roll out into 12 inch square. Fold into thirds. Wrap and place into refrigerator for 20 to 30 minutes. Fold and roll twice more. Wrap and chill after each rolling. After the final folding, chill several hours or overnight.



8 Cut dough crosswise into thirds. Cut each third in thirds. Cut each third diagonally to form two triangles.

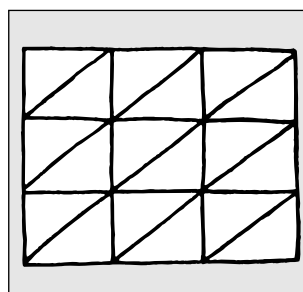

9 Roll up each triangle loosely, starting from the side opposite the point. Curve ends.



10 Place seam side down on a greased baking pan. Spray water on top. Proof at 90°F for 30 to 50 minutes or until nearly doubled.



11 Brush with beaten egg. Bake in 375°F oven for 10 to 15 minutes or until golden brown.

Select DOUGH mode

C=cup(s), tsp=teaspoon(s), TBSP=Tablespoon(s)

<Note for measuring flour>

The amounts shown in () are not as precise as weight measurements.

For better results, please use weight measurements. (1 cup = 4.92 oz.)

Variation: Danish Pastries (Yield 8)

10 ³ / ₄ oz. (2 ³ / ₁₆ C)	bread flour
5 ¹ / ₄ oz. (1 ¹ / ₈ C)	cake flour
3 TBSP	dry milk
1 tsp	salt
2 oz.	butter or margarine
6 fl.oz. (¾ C)	water
2 tsp	dry yeast
7 oz.	butter or margarine for folding in the dough
1	egg, beaten for brushing on top

Fillings

½ ¾ C	apricot jam or marmalade
¼ ⅓ C	canned fruit filling or preserves
½ ¾ C	nut streusel
½ ¾ C	cheese filling

() : measurements not as precise as weight measurements.

1 Follow steps 1 to 6 on P.29. Follow step 7, but repeat the process of folding into thirds and placing in the refrigerator four times, instead of three. Finally, wrap and chill for several hours or overnight.

2 Roll out the dough into 14X17 inches. Cut into 8 squares. Roll each out into about 7 inch square.

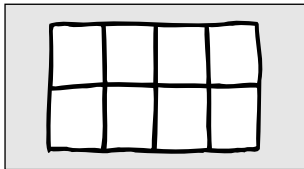

3 Place the filling of your choice in the center of each square. Brush the four corners lightly with water to help them seal when pressed together.

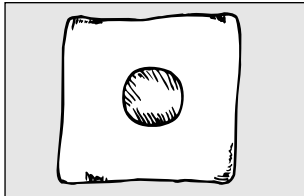

4 Fold two opposite corners over the center. Press down firmly to seal together.

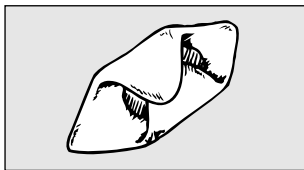

5 Fold the other two corners over the center and press all four corners tightly together.

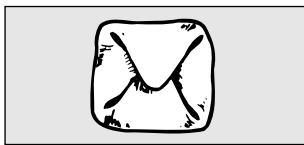

6 Place on greased baking pan. Spray water on top.

7 Proof, brush with beaten egg and bake as croissants.

Brioche (Yield 12)

16 oz. (3 ¹ / ₄ C)	bread flour
2 TBSP	sugar
1 ¹ / ₂ TBSP	dry milk
1 ¹ / ₂ tsp	salt
3 fl.oz. (¾ C)	water
3 oz. (½ C)	butter or margarine
4	eggs
2 ¹ / ₂ tsp	dry yeast
1	egg, beaten for brushing on top

12 brioche or cake cups

() : measurements not as precise as weight measurements.

1 Make the dough according to instructions on P.7—9.

2 Place the dough in a greased bowl. Cover. Rest the dough in the refrigerator for 30 minutes.

3 Divide the dough into 12 equal portions. Roll each portion into a ball. Cover with a plastic wrap and rest for 20 minutes.

4 Using the edge of the hand, pinch off about one-fourth of the dough without detaching it. Roll the dough on the bench so that both parts are round.

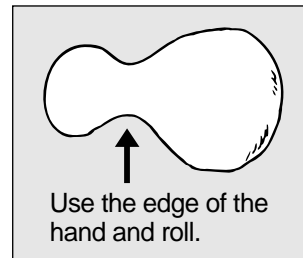

5 Place the dough in the tin large-end first. With fingertips, press the small ball around its circumference into the large one.

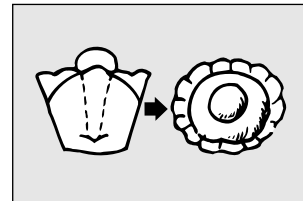

6 Place tins on baking pan. Spray water on top. Proof at 90°F for 30 to 50 minutes or until the larger ball rises above the tin.

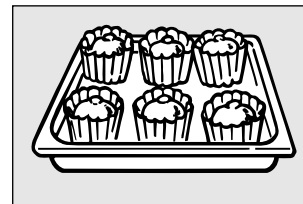

7 Brush with beaten egg. Bake in 350°F oven for 10 to 15 minutes or until golden brown.

Pizza Dough

C=cup(s), tsp=teaspoon(s), TBSP=Tablespoon(s)

<Note for measuring flour>

The amounts shown in () are not as precise as weight measurements. For better results, please use weight measurements. (1 cup = 4.92 oz.)

Pizza (Use pizza program)

Ingredients: Makes 6 small or 2 large

1 tsp	dry yeast
16 ³ / ₄ oz. (3 ³ / ₈ C)	bread flour
1 TBSP	milk powder
1 ³ / ₄ TBSP	sugar
1 tsp	salt
1 TBSP	butter
11 ³ / ₄ fl.oz.	water

²/₃ cup tomato paste, for brushing on top

3 cups Mozzarella cheese, for sprinkling on top

() : measurements not as precise as weight measurements.

- 1 Press MENU until arrow points at pizza .
Press Start/Stop.
- 2 Knead dough on a lightly floured surface until it becomes elastic and springs back when touched.
- 3 Divide into 6 balls or 2 large balls, and place in warm area for 10 minutes.
- 4 Shape each ball into a flat circle. Place the circles on a baking tray and prick with a fork.
- 5 Let rest for 15 minutes at room temperature.
- 6 Brush each circle with 2 tablespoons tomato paste. Sprinkle with Mozzarella cheese. Top with your favorite topping, such as sliced onions, pepperoni, prochuto ham, olives.
- 7 Bake in a preheated 340...F oven for 15—20 minutes.

Focaccia (Use pizza program)

Ingredients: Makes 1 large

2 tsp	dry yeast
16 ³ / ₄ oz. (3 ³ / ₈ C)	bread flour
2 TBSP	milk powder
2 TBSP	sugar
2 tsp	salt
2 TBSP	olive oil
11 ¹ / ₈ fl.oz.	water
1 tsp	bread improver, optional

Topping:

¹ / ₄ C	olive oil
1 TBSP	fine sea salt
2 tsp	dried oregano
2 tsp	dried basil
(1 cup bread flour, extra for kneading)	

() : measurements not as precise as weight measurements.

- 1 Press MENU until arrow points at pizza .
Press Start/Stop.
- 2 Knead dough on a lightly floured surface until it becomes elastic and springs back when touched.
- 3 Shape into a flat circle, place on a baking tray, make holes with the end of a wooden spoon 5 cm apart over the surface of the dough.
- 4 Cover and let rest in a warm place for 20—25 minutes until almost doubled in size.
- 5 Brush surface with olive oil, sprinkle with sea salt, oregano and basil.
- 6 Bake in a preheated 340...F oven for 26—30 minutes.

C=cup(s), tsp=teaspoon(s), TBSP=Tablespoon(s)

<Note for measuring flour>

The amounts shown in () are not as precise as weight measurements. For better results, please use weight measurements. (1 cup = 4.92 oz.)

This program can be used for baking cakes and tea breads. It is not suitable for all types of cake, such as light sponge cakes, Christmas pudding, or those that require going into a hot oven. Make sure that the kneading blade is removed from the pan and the bottom and sides of the bread pan are lined with a waxed baking paper before the cake mixture is added. Ensure that the cake mixture is kept inside the baking sheet. The maximum baking time is 1 hour and 30 minutes.

Banana Tea Loaf

8 oz. (1 ⁵ / ₈ C)	self raising flour
1/4 tsp	bicarbonate of soda
1/2 tsp	salt
3 oz.	butter
2 oz.	caster sugar
1 lb 2 oz.	bananas (with skin), peel & mash
1	medium sized egg, beaten

Optional glaze: apricot jam
walnut/banana chips

() : measurements not as precise as weight measurements.

- 1 Sieve flour, salt, bicarbonate of soda together into a bowl.
- 2 Rub the butter into the flour until it resembles fine breadcrumbs.
- 3 Stir in the sugar, bananas and the beaten egg, mix well.
- 4 Remove the kneading blade from the bread pan and line the bottom and sides with baking parchment.
- 5 Place the mixture into the bread pan, being careful to ensure that the mixture is inside the baking parchment.
- 6 Select the bake only program and enter 45 minutes on the timer.
- 7 After baking, test with a skewer to see if the cake is cooked. If the cake requires extra time, select the bake only program again and enter a further 3 — 5 minutes on the timer. If it is still just slightly sticky, this will cook through during the stand period.
- 8 Take the bread pan out of the bread maker using oven gloves and leave to stand for 5 — 10 minutes before removing from the bread pan and allowing to cool.
- 9 Glaze if desired. Soften the jam, spread over the top of the warm teabread, and sprinkle with walnut or banana chips.

Fruity Cake

12 oz.	mixed dried fruit
2 oz.	chopped dates
2 oz.	chopped walnuts
4 oz.	chopped cherries
10 fl.oz.	water
3 oz.	butter
3	medium sized eggs, beaten
9 oz. (1 ¹³ / ₁₆ C)	plain flour
1 tsp	bicarbonate of soda (baking soda)

() : measurements not as precise as weight measurements.

- 1 Place the fruit, dates, walnuts, cherries, water and butter together and heat until the fat has melted and the liquid is hot. This can be done on the hob or in the microwave oven. (High power for 4 — 5 minutes)
- 2 Allow to cool slightly, then add eggs, flour and the bicarbonate of soda. Mix well.
- 3 Remove the kneading blade from the bread pan and line the bottom and sides with baking parchment.
- 4 Place the mixture into the bread pan, being careful to ensure that the mixture is inside the baking parchment.
- 5 Select bake only program and enter 55 minutes on the timer.
- 6 After baking, test with a skewer to see if the cake is cooked. If the cake requires extra time, select the bake only program again and enter a further 3 — 5 minutes on the timer. If it is still slightly sticky, this will cook through during the stand period.
- 7 Take the bread pan out of the bread maker using oven gloves. Leave to stand for 5 — 10 minutes before removing from the bread pan and allowing to cool.

BAKE ONLY

C=cup(s), tsp=teaspoon(s), TBSP=Tablespoon(s)

<Note for measuring flour>

The amounts shown in () are not as precise as weight measurements. For better results, please use weight measurements. (1 cup = 4.92 oz.)

Gingerbread

1 oz.	demerara sugar
3 oz.	butter
2 oz.	golden syrup
3 oz.	black treacle
8 oz. (1 ⁵ / ₈ C)	plain flour
1 ¹ / ₂ tsp	ground ginger
1 ¹ / ₂ tsp	baking powder
1/2 tsp	bicarbonate of soda
1/2 tsp	salt
5 fi.oz.	milk
1	medium sized egg, beaten

() : measurements not as precise as weight measurements.

- 1 Warm sugar, butter, golden syrup and treacle together until just melted. This can be done on the hob or in the microwave oven (High power for 1 minute).
- 2 Stir in all of the sieved dry ingredients.
- 3 Mix in the milk and the beaten egg.
- 4 Beat thoroughly with a wooden spoon.
- 5 Remove the kneading blade from the bread pan and line the bottom and sides with baking parchment.
- 6 Place the mixture into the bread pan, being careful to ensure that the mixture is inside the baking parchment.
- 7 Select bake only program and enter 35 minutes on the timer.
- 8 After baking, test with a skewer to see if the cake is cooked. If the cake requires extra time, select the bake only program again and enter a further 3 — 5 minutes on the timer. If it is still just slightly sticky, this will cook through during the stand period.
- 9 Take the bread pan out of the bread maker using oven gloves. Leave to stand for 5 — 10 minutes before removing from the bread pan and allowing to cool.

Marbled Chocolate & Vanilla Cake

8 oz.	butter
3 oz.	caster sugar
4	medium sized eggs
8 oz. (1 ⁵ / ₈ C)	self raising flour
1 tsp	vanilla essence
3 oz.	plain chocolate
1 TBSP	milk
1 TBSP	cocoa powder

() : measurements not as precise as weight measurements.

- 1 Cream together the butter and the sugar.
- 2 Beat in the eggs gradually.
- 3 Fold in the flour, then divide the mixture into two bowls.
- 4 Add the vanilla essence to one bowl and mix in.
- 5 Melt the chocolate with the milk and add to the other bowl with the cocoa powder, mix well.
- 6 Remove the kneading blade from the bread pan and line the bottom and sides with baking parchment.
- 7 Place alternate spoonfuls of the vanilla and chocolate mixture into the bread pan, being careful to ensure that the mixture is inside the baking parchment. Then using a spoon lightly swirl the two colours together so that they combine but are not mixed.
- 8 Select the bake only program and enter 50 minutes on the timer.
- 9 After baking, test with a skewer to see if the cake is cooked. If the cake requires extra time, select the bake only program again and enter a further 3 — 5 minutes on the timer. If it is still just slightly sticky, this will cook through during the stand period.
- 10 Take the bread pan out of the bread maker using oven gloves. Leave to stand for 5 — 10 minutes before removing from the bread pan and allowing to cool.

Panasonic Consumer Electronics Company, Division of Matsushita Electric Corporation of America
One Panasonic Way
Secaucus, New Jersey 07094

Panasonic Sales Company, Division of Matsushita Electric of Puerto Rico, Inc
Ave. 65 de Infanteria, Km. 9.5
San Gabriel Industrial Park,
Carolina, Puerto Rico 00985

PANASONIC

Automatic Bread Maker Limited Warranty

Panasonic Consumer Electronics Company or Panasonic Sales Company (collectively referred to as the Warrantor) will repair or replace this product with new or refurbished parts or equivalent product, free of charge in the USA or Puerto Rico, for one (1) year from the date of the original purchase in the event of a defect in materials or workmanship.

Carry-in or mail-in service in the USA can be obtained during the warranty period by contacting a Panasonic Services Company (PASC) Factory Servicenter listed in the Servicenter Directory. Or call, toll free, 1-800-211-7262 to locate a PASC Authorized Servicenter. Carry-in or mail-in service in Puerto Rico can be obtained during the warranty period by calling the local Panasonic Sales Company telephone number listed in the Servicenter Directory.

This warranty is extended only to the original purchaser. A purchase receipt or other proof of date of original purchase will be required before warranty service is rendered.

When shipping the unit carefully pack it and send it prepaid, adequately insured and preferably in the original carton. Include a letter detailing the complaint and provide a day time phone number where you can be reached.

Also, the purchaser will be responsible for shipping the unit to a PASC Factory Servicenter or PASC Authorized Servicenter.

This warranty only covers failures due to defects in materials and workmanship which occur during normal use. The warranty does not cover damage which occurs in shipment, or failures which are caused by products not supplied by the warrantor, or failures which result from accident, misuse, abuse, neglect, mishandling, faulty installation, misapplication, set-up adjustments, improper operation or maintenance, alteration, modification, introduction of sand, humidity or liquids, power line surge, improper voltage supply, lightning damage, maladjustment of consumer controls, improper operation, commercial use such as hotel, office, restaurant, or other business or rental use of the product, or service by anyone other than a PANASONIC SERVICES COMPANY authorized repair facility, or damage that is attributable to acts of God.

LIMITS AND EXCLUSIONS

There are no express warranties except as listed above.

THE WARRANTOR SHALL NOT BE LIABLE FOR INCIDENTAL OR CONSEQUENTIAL DAMAGES RESULTING FROM THE USE OF THIS PRODUCTS, OR ARISING OUT OF ANY BREACH OF THE WARRANTY. ALL EXPRESS AND IMPLIED WARRANTIES, INCLUDING THE WARRANTIES OF MERCHANTABILITY AND FITNESS FOR PARTICULAR PURPOSE, ARE LIMITED TO THE APPLICABLE WARRANTY PERIOD SET FORTH ABOVE

Some states do not allow the exclusion or limitation of incidental or consequential damages, or limitations on how long an implied warranty lasts, so the above exclusions or limitations may not apply to you. This warranty gives you specific legal rights and you may also have other rights which vary from state to state.

If you have a problem with this product that is not handled to your satisfaction, then write to the Consumer Affairs Department at the Company address indicated above.



**Panasonic Consumer Electronics
Company, Division of Matsushita
Electric Corporation of America**
One Panasonic Way Secaucus,
New Jersey 07094

**Panasonic Sales Company,
Division of Matsushita Electric
of Puerto Rico, Inc**
Ave. 65 de Infanteria, Km. 9.5
San Gabriel Industrial Park, Carolina,
Puerto Rico 00985

DZ50A1341
Printed in China