

This Owner's Manual is provided and hosted by [Appliance Factory Parts](#).

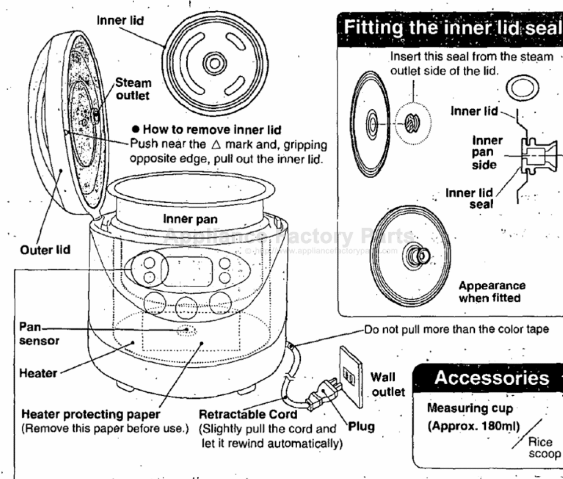

PANASONIC SR-CF05P Owner's Manual

[Shop genuine replacement parts for PANASONIC SR-CF05P](#)



[Find Your PANASONIC Small Appliance Parts - Select From 148 Models](#)

----- Manual continues below -----

Panasonic®

Electronic Rice Cooker/Warmer

ジャー炊飯器

微型電腦飯煲

전자 밥솥/보온기

Operating Instructions

取扱説明書

使用説明書

취급설명서

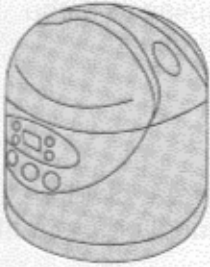

SR-CF05P



Thank you for purchasing the Panasonic Electronic Rice Cooker/Warmer.
For optimum performance and safety, please read these instructions carefully.

この度はパナソニックジャー炊飯器をお買い上げいただき、まことにありがとうございます。
この説明書をよくお読みのうえ、正しくお使いください。

感謝您購買 Panasonic 微型電腦飯煲。為能正確使用及維護您的安全，請詳閱本
說明書。

내셔널 전기 밥솥을 구입하여 주셔서 대단히 감사합니다.

최고의 성능과 안전을 위해 본 사용설명서를 상세히 참조하여 주시기 바랍니다.

IMPORTANT SAFEGUARDS

Do not attempt to operate this appliance before reading all instructions.

When using electrical appliance, basic safety precautions should always be followed, including the following:

DANGER

To avoid injury from electric shock,

- (1) Do not immerse cord, plugs or Rice Cooker (except pan) in water or any other liquid.
- (2) Do not operate any appliance with a damaged cord or plug or after the appliance malfunctions or has been damaged in any manner. Return the appliance to the nearest authorized service facility for examination, repair or adjustment.

WARNING

To avoid risk of electric shock or injury from burns:

- (1) Do not touch hot surfaces. Use handles or knobs.
- (2) Close supervision is necessary when any appliance is used by or near children.
- (3) Unplug from outlet when not in use and before cleaning. Allow to cool before putting on or taking off parts.
- (4) The use of accessory attachments not recommended by the appliance manufacturer may result in fire, electric shock, or injury to persons.
- (5) Do not use outdoors.
- (6) Do not let the cord hang over the edge of table or counter, touch hot surface. Do not place anything on the cord.
- (7) Extreme caution must be used when moving an appliance containing hot liquids.
- (8) Always attach plug to appliance first, then plug cord into a wall outlet. To disconnect, turn any control to "OFF", then remove from plug from wall outlet.
- (9) Do not use this appliance for other than its intended use.
- (10) Oversize foods, metal foil packages, or utensils must not be inserted in the appliance as they may involve a risk of fire or electric shock.
- (11) A fire may occur if the appliance is covered or touching flammable material, including curtains, draperies, walls, and the like, when in operation.

SAVE THESE INSTRUCTIONS

- (12) This product is intended for household use only, and not for commercial applications.

CAUTION

- (1) Do not place on or near a hot gas or electric burner, or in a heated oven.

NOTE

- (A) A short power supply cord is provided to reduce the risk resulting from a long cord snagging, being crimped, or otherwise creating the risk of injury to a person or damage to the cord.
 - (B) Longer detachable power supply cords or extension cords are available and may be used if care is exercised in their use.
 - (C) If a longer detachable power-supply cord is used,
 - (1) The marked electrical rating of the cord should be at least as great as the electrical rating of the appliance, and
 - (2) The cord should be arranged so that it will not drape over the countertop or tabletop where it can be pulled on by children or tipped over unintentionally.
-

This appliance has a polarized plug; (one blade is wider than the other). As a safety feature, this plug will fit into a polarized outlet only one way. If the plug does not fit fully into the outlet, reverse the plug. If it still does not fit, contact a qualified electrician. Do not attempt to defeat this safety feature.

Contents

Cautions	3
Before using the products	5
● Parts Identification	5
● Accessories	5
● How to adjust the current time	5
How to Cook Rice	6·7
● Quick Cook	7
Preset Timer	7
Reheat Rice	8
Cook Timer	8
Keep Warm function	8
How to Clean	21
Specifications	Back Cover

もくじ

安全上のご注意	3
お使いになる前に	9
●各部のなまえと使い方	9
●付属品の確認	9
●現在時刻の合わせ方	9
ごはんの炊きかた	10·11
●高速炊飯	11
予約炊飯	11
あつあつ再加熱	12
クックタイマー	12
保温について	12
お手入れのしかた	21
仕様	裏表紙

目錄

安全上の注意事項	4
使用之前	13
●零件名稱	13
●附件的確認	13
●現在時間的調整方法	13
煮飯的方法	14·15
●快速煮飯	15
預約煮飯	15
再加熱	16
炊煮定時器	16
有關保温	16
整理保養方法	22
規格	封面

차례

안전에 대한 주의사항	4
사용하기 전에	17
●각부의 명칭과 사용방법	17
●부속품 확인	17
●현재시각 맞춤법	17
밥짓기	18·19
●고속 취반	19
예약취반	19
뜨끈뜨끈 재가열	20
쿠킹 타이머	20
보온에 대해서	20
손질방법	22
사양	뒷표지

Cautions

- Plug into properly wired wall outlet. Before you plug in, make sure the voltage of the unit is the same as your local supply.
- Do not immerse the unit in water.
- Paper located between the pan and the heating plate should be removed before use.
- Always keep the outside bottom of the pan and the heating plate clean and dry. Any foreign matter between them will cause cooker to malfunction.
- Do not cover the lid with a cloth. The lid may deform or change color.
- When removing the inner pan from the body, be sure to leave the power plug out of the outlet.
- Set the unit on a stable surface. Do not expose to water, high humidity or heat sources. Do not use the pan directly on open flame.
- Never try to use other than the specified pan.
- Carefully keep the product away from within the reach of children. Be sure to keep the cooker out of the reach of children, especially when cooking. Accidentally pressing the keys may stop the cooker.
- Do not cover the lid with your hand or place your face directly over the steam coming from the cooker. The cooker becomes hot when in use.
- Do not make over, take apart or attempt to repair.

Consult your nearest sales outlet or repair center for repairs.

安全上のご注意

- 電源プラグは根元まで確実に差し込む。
交流120V以外は使用しない。
- 水につけたり水をかけたりしない。
- 内なべとヒーターの間にあるヒーター保護紙は
お使いになる前に取り出してください。
- なべ底に異物、水滴がついたまま使用しない。
故障の原因になります。
- ふたの上にふきんをかけない。
ふたの変形、変色、ひび割れの原因となります。
- 内なべを取り出したときは、必ず電源プラグを抜く。
- 不安定な場所で使わない。
水のかかる所や、火気の近くで使わない。
内なべを直接火にかけない。
- 専用の内なべ以外は使わない。
- 子供など取り扱いに不慣れな方だけで使わせたり、
乳幼児の手の届く所で使わない。
炊飯中誤って操作ボタンを押すと誤動作の原因と
なります。
- 蒸気口に顔や手を近づけない。
炊飯中、本体は熱くなります。
- 絶対に改造、分解、修理をしない。

修理は、お買い上げの販売店または修理相談窓口にご相談ください。

Before using the product

Parts Identification

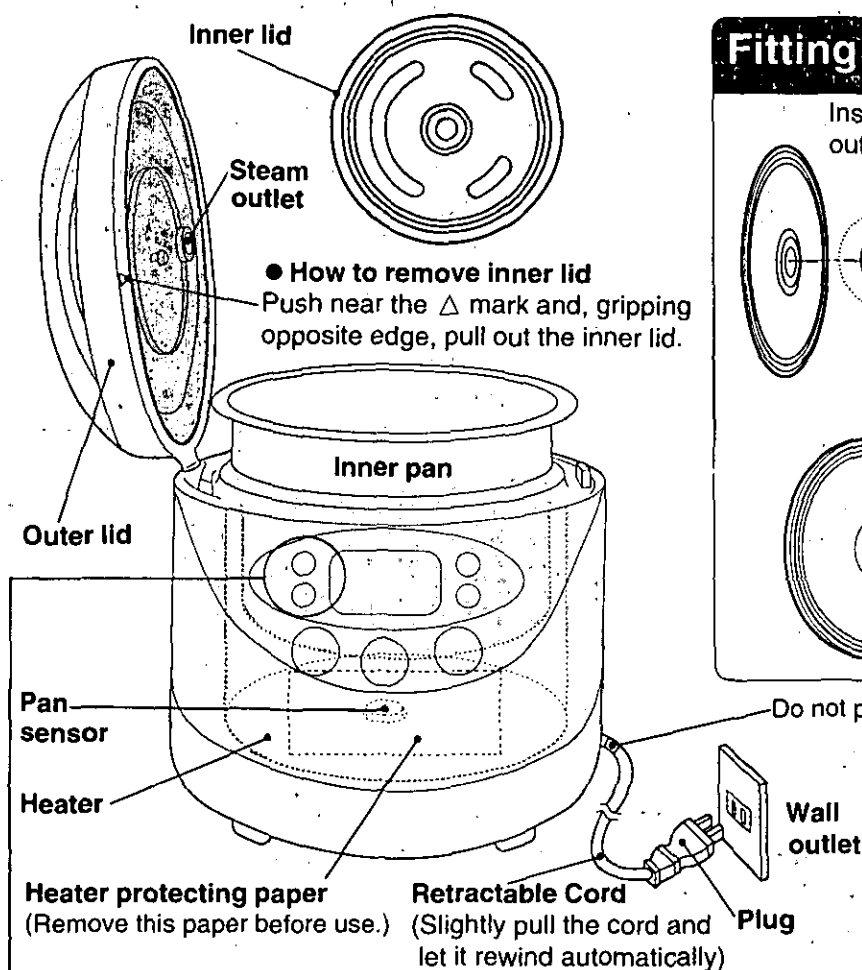

Fitting the inner lid seal

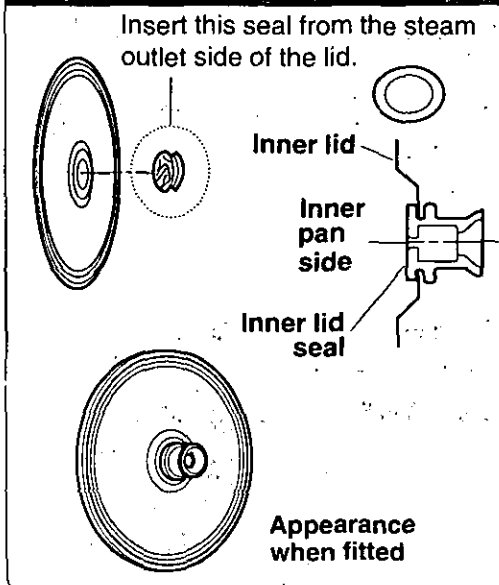

Accessories

Measuring cup
(Approx. 180ml)

Rice scoop

How to adjust the current time.

(Set the time accurately)

1 Plug in.

Do not pull the power cord beyond the colored tape.

2 Adjust the current time.

- Press (Hrs) or (Min) key. The display will start blinking. The clock can be adjusted, while the display is blinking.
- Keep the (Hrs) or (Min) key pressed down to fast forward.
- The time display stops blinking after five seconds.

Display window Hour Minute

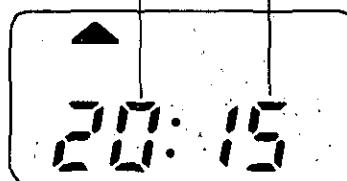

Ex. PM 8:15

Note

- When setting the time at 12 midnight, the time set is 0:00.
- The time cannot be set while cooking, warming or using the preset function.

How to Cook Rice

Control Panel switch

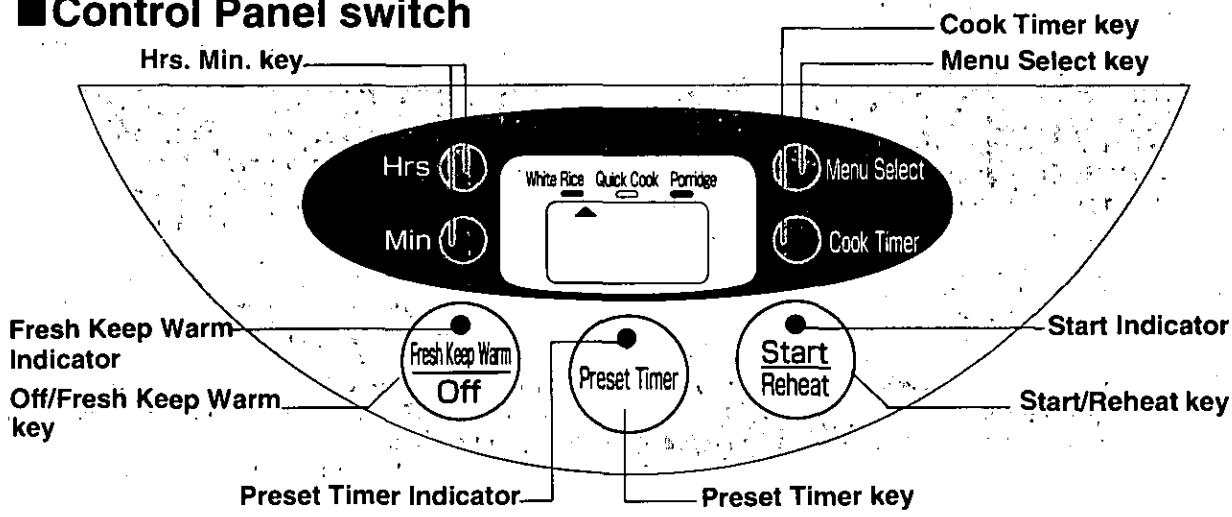

Preparation

1 Measure rice with the provided measuring cup. Rinse rice until water becomes relatively clear.

- Rice can be rinsed in rice cooker inner pan.

2 Add water.
 ■ To cook White Rice or Mixed rice e.g. For 1 cup of rice, add water to LEVEL INDICATOR 1.

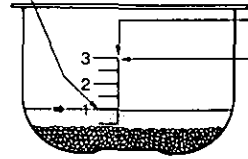

LEVEL INDICATOR
 MAXIMUM LEVEL
 Do not cook with more than this level of water.

- To cook Porridge, rice and water are to be measured with the provided measuring cup.

Rice amount	Water amount
1/2 cup	2 cups
1 cup	3 1/2 cups

* Above table is just for your reference. Adjust amount of water to your personal taste.

3 Attach the inner lid onto the outer lid. Place the pan in the body. Make sure that the pan is directly in contact with the heating plate by turning it slightly from right to left until it seats properly.

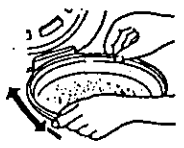

- Wipe the surface of the pan before use. If it is wet, it may cause noise while cooking. It may also damage the unit.

4 Close the outer lid. Make sure to lock properly until it clicks. Plug in.

- If the outer lid is not securely closed, cooking will be affected.
- Do not open the outer lid when in use.

Start to Cook

5 Press (Menu Select) key to select menu. ▲△ indicator shows the menu which is selected.

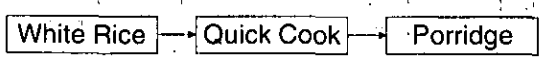

- When cooking Mixed rice, select [White Rice] course.
- When cooking porridge set the ▲ indicator to [Porridge] on the control panel. Otherwise it will boil over.

- 6** Press **(Start)** key to start cooking:
- Start indicator comes on.
 - The unit displays the remaining time as follows:

White Rice	Quick Cook	Porridge
13 min.	10 min.	8 min.

Time until ready for eating (Approx.)		
White Rice	Quick Cook	Porridge
55 min.	29-42 min.	63 min.

Precook course

When rinsed rice is soaked in water for more than 30 minutes, Precook course, which lets rice absorb water, may be shortened by pressing **(Start)** key twice.

Quick Cook Course

- Cooking is finished approximately 20 minutes sooner than with normal rice cooking.
- This is a heating method that gives priority to shortening cooking time. Thus, the rice may be a little firmer and more browned than usual.
- Do not use Quick cook course for Mixed rice.
- Precook cut and Preset timer features cannot be used with Quick cook.

- 7** When the cooking is done, the buzzer sounds with automatic transition to warming.

- 8** Fluff rice as soon as possible (within 30 minutes) after the beeper sounds.
- After use, press Keep Warm/Off key and disconnect the plug.
If you fail to press the key, warming starts automatically when the plug is connected the next time.

- Keep warm function should only be used with plain white rice. Warming other kind of rice menus is not recommended.
- Rice may be too sticky if it is not fluffed.

Preset Timer Set the time you want to eat

- Menus allowing use of timer and allowable time setting.

White Rice	1 hour 10 minutes ~ 13 hours
Porridge	

- 1** Confirm that the currently indicated time is correct.

Select White Rice or Porridge by pressing **(Menu Select)** key.

- 2** Press **(Preset Timer)** key to set the timer.

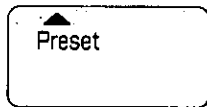

- 3** Press **(Hrs)** and **(Min)** key to set the time you want to eat.

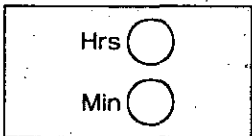

- After setting the timer

➔ To change this time setting, press **(Off)** key and set again.

- [Min] key advances in 10 minutes increments.

- 4** Press **(Start)** key. (Preset Timer indicator comes on to show the timer is set.)

- If the present time is set at more than 13 hours in advance, the time will automatically revert to 13 hours and the rice cooked in 13 hours.

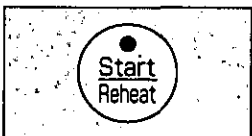

Caution

- Do not put any ingredients or seasonings into the cooker when using the timer.

Note

- When cooking with Preset Timer Rice may become more soft, or more browned than usual.
- The remaining time is not displayed.

Reheat Rice

Reheat the rice during keep warm to make rice hotter.

- 1**
- Fluff rice and make the surface of it flat.
 - Be sure to fluff rice. Otherwise rice may be browned.

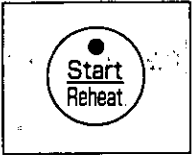
- 2**
- 
- Press **Reheat** key
(Fresh Keep Warm indicator lamp starts blinking)
- The reheating time is about 5 minutes.
 - The beeper sounds with automatic transition to warming.
(Keep Warm indicator lamp comes on.)

3 Fluff rice

- After setting the reheat function
→ To cancel this setting, press [Off] key.

Press **off** key again to keep rice warm.

■ Caution when using Reheat function

- Do not use Reheat function when Keep Warm indicator does not light, because rice cooking function will start.
- Do not use Reheat function except for White Rice, because it may cause browning, or discoloration.
- Reheat function can not be used when the temperature of rice is under 65°C. (Beeper sounds 4 times to let you know that Reheat function was rejected.)
- To prevent rice from drying out.
 - Do not repeat Reheat function.
 - Do not use Reheat function for a small amount of rice.
→ When a small amount of rice is to be reheated, fluff rice and make its surface flat and sprinkle approx. 1 teaspoon water for 1 cup of rice (approx. 165g) in order to keep rice from drying out too much.
- Rice can not be warmed adequately when the amount of rice in the pan is more than 1/2 capacity.

Cook Timer

Put the ingredients and cold or hot water into the pan.

Amount of water to use

Put in 1[1/2] to 2[2/3] cups of water

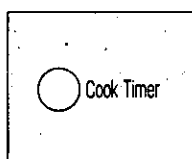
- 1**
- 
- Press **Cook Timer** key to **set the time**
- One push brings up [Cook] on the display.
 - Each push then changes the time through a 60-minute cycle: e.g. 5 min. → 6 min. → ...60 min. → 1 min. → 5 min., etc.

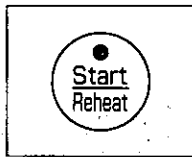
- 2**
- 
- Press **Start** key.
- After cooking has started, the time on the display counts down in one minute intervals.
- When cooking is done there is an audible signal and the rice cooker automatically goes into keep warm mode.

Information

- Rice porridge can not be made from cooked rice with Cook Timer functions.

Note

- To avoid smells, wash the inner pan immediately after use.
- After use press [Off] key and disconnect the plug.

Keep Warm Function

- To avoid smells and discoloration, do not use keep warm mode for more than 12 hours.
- The timer indicates the keep warm period for up to 23 hours, after that the keep warm mode continues to operate, but the timer will recycle to the next 24-hour period.

Time indicated for keep warm period of less than 1 hour

 [h: hour]

- When only a small amount of rice is being kept warm, to avoid excess drying, gather it compactly into the center of the inner pan and occasionally fluff it, sprinkling in a small spoonful of water (approx. 5 cc) per portion of rice.

- Do not use the keep warm mode for mixed rice or rice porridge.
- It is not unusual for there to be condensation on the inner lid when the keep warm mode is used.

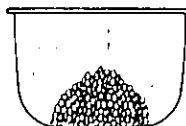

LIMITED WARRANTY PANASONIC ELECTRONIC RICE COOKER/WARMER

Panasonic Company (West) of America will repair and exchange parts for this ELECTRONIC RICE COOKER/WARMER free of charge in the U.S.A. in the event of a manufacturing defect, as follows:

Parts:
New or comparable rebuilt parts in exchange for defective parts for one (1) year after the date of original purchase.

Labor:
Carry-in service for one (1) year after the date of original purchase.

Service:
Carry-in service can be obtained during the warranty period by bringing or mailing your ELECTRONIC RICE COOKER/WARMER to Panasonic Company (West) of America or to authorized service agencies.

This warranty does not cover the postage, freight, or delivery fee for sending the product to and from the service center.

A purchase receipt or other proof of date of original consumer purchase will be required before warranty service is rendered. This warranty covers normal consumer use and does not cover damage which occurs in shipment or failure which results from alteration, accident, misuse, abuse, neglect, installation, improper maintenance or commercial use. If a problem with this product develops during the warranty period, please contact your Panasonic dealer. If the problem is not solved to your satisfaction then write to:

Panasonic Company (West) of America
Division of Matsushita Electric Corporation of America
Specialty Product Section
6550 Katella Ave.
Cypress, California 90630

IMPORTANT NOTICE

Please complete and mail the Purchase Information Card. It may be our only way of contacting you should any problem develop with the product you have purchased.

SR790M088-X Printed in Japan

PANASONIC PURCHASE INFORMATION CARD

Thank you for purchasing this Panasonic product in order to serve you better in the future, we would appreciate your answering the following questions. Your return of this card will enable us to contact you regarding this product should the need arise. Your assistance is greatly appreciated.

1. Mr. Mrs. Ms. Miss.

First Name Initial Last Name

--	--	--

Street

--

City State Zip

--	--	--

2. Telephone Number 3. Date of Purchase

--	--	--	--	--	--

4. Price purchased 5. Type of retail outlet Month Date Year

--	--	--	--	--	--

6. Dealer's Name

--

7. Dealer's Address(state)

--

8. Model No: SR-

FOR YOUR PROTECTION

Complete and mail Purchase Information Card immediately, so that we may contact you directly in the event a safety notification is issued in accordance with the 1972 Consumer Product Safety Act, or for other reasons Panasonic Company (West) of America may deem necessary.

WHEN YOU SHIP THE PRODUCT

Carefully pack and send it postage or freight charge prepaid, adequately insured and preferably in the original carton. Enclose return-postage affixed letter or note, specifying the problem, in the shipping carton.

Customer's Record

Model No. **SR-** Serial No. _____
Dealer's Name _____
Address _____
Date of Purchase _____

IMPORTANT:Please mail the Purchase Information Card immediately.

POST CARD

PLACE
FIRST-CLASS
STAMP
HERE

Panasonic Company (West) of America,
Division of Matsushita Electric Corporation of America
Specialty Product Section
6550 Katella Ave.
Cypress, California 90630.

Specifications 仕様 規格 사양

Model		SR-CF05P
Power Supply		120V
Power consumed (Approx.) W	Cooking	280
	Keep warm	280(11)
Cooking capacity L	White Rice	0.09-0.54(0.5-3 cups)
	Mixed Rice	0.18-0.36(1-2 cups)
	Rice Porridge	0.09-0.18(0.5-1 cups)
Cord Length m		1.2
Weight(Approx.) kg		1.7
Dimensions(H×W×D)(Approx.) cm		21.5×21.5×24.5

品番		SR-CF05P
電源		120V
消費電力(約)W	炊飯時	280
	保温時	280(11)
炊飯容量 L	白米(高速)	0.09-0.54(0.5-3 cups)
	炊き込み	0.18-0.36(1-2 cups)
	おかゆ	0.09-0.18(0.5-1 cups)
コード長さ m		1.2
質量(約) kg		1.7
大きさ(高さ×幅×奥行)(約) cm		21.5×21.5×24.5

型號		SR-CF05P
電源		120V
消費電力(大約) W	煮飯時	280
	保温時	280(11)
米的容量 L	白飯(快速)	0.09-0.54(0.5-3cups)
	什錦飯	0.18-0.36(1-2cups)
	稀飯	0.09-0.18(0.5-1cups)
電源線長度 m		1.2
重量(大約) kg		1.7
尺寸(高×寬×深)(大約) cm		21.5 × 21.5 × 24.5

품번		SR-CF05P
전원		120V
소비전력(약) W	밥지을 때	280
	보온시	280(11)
밥짓기용량 L	쌀밥(고속취반)	0.09-0.54(0.5-3 cups)
	섞어짓기	0.18-0.36(1-2 cups)
	죽	0.09-0.18(0.5-1 cups)
코드길이		1.2
질량(무게)(약) kg		1.7
크기(H x W x D)(약) cm		21.5 x 21.5 x 24.5

Panasonic Consumer Electronics Company.
 Division of Matsushita Electric Corporation of America
 One Panasonic Way Secaucus, New Jersey 07094
 Printed in Malaysia

SH9709-1107
 RZ19A417