

This Owner's Manual is provided and hosted by [Appliance Factory Parts](#).

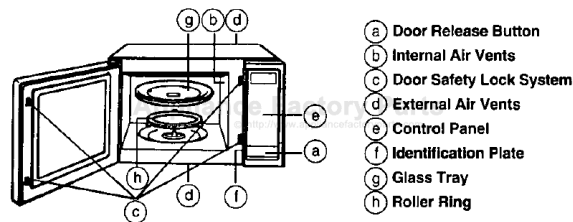

# PANASONIC MQS0660 Owner's Manual

[Shop genuine replacement parts for PANASONIC  
MQS0660](#)



[Find Your PANASONIC Microwave Parts - Select From 742 Models](#)

----- Manual continues below -----

**Quasar®**

# Operating Instructions

Microwave Oven  
Model MQS0660

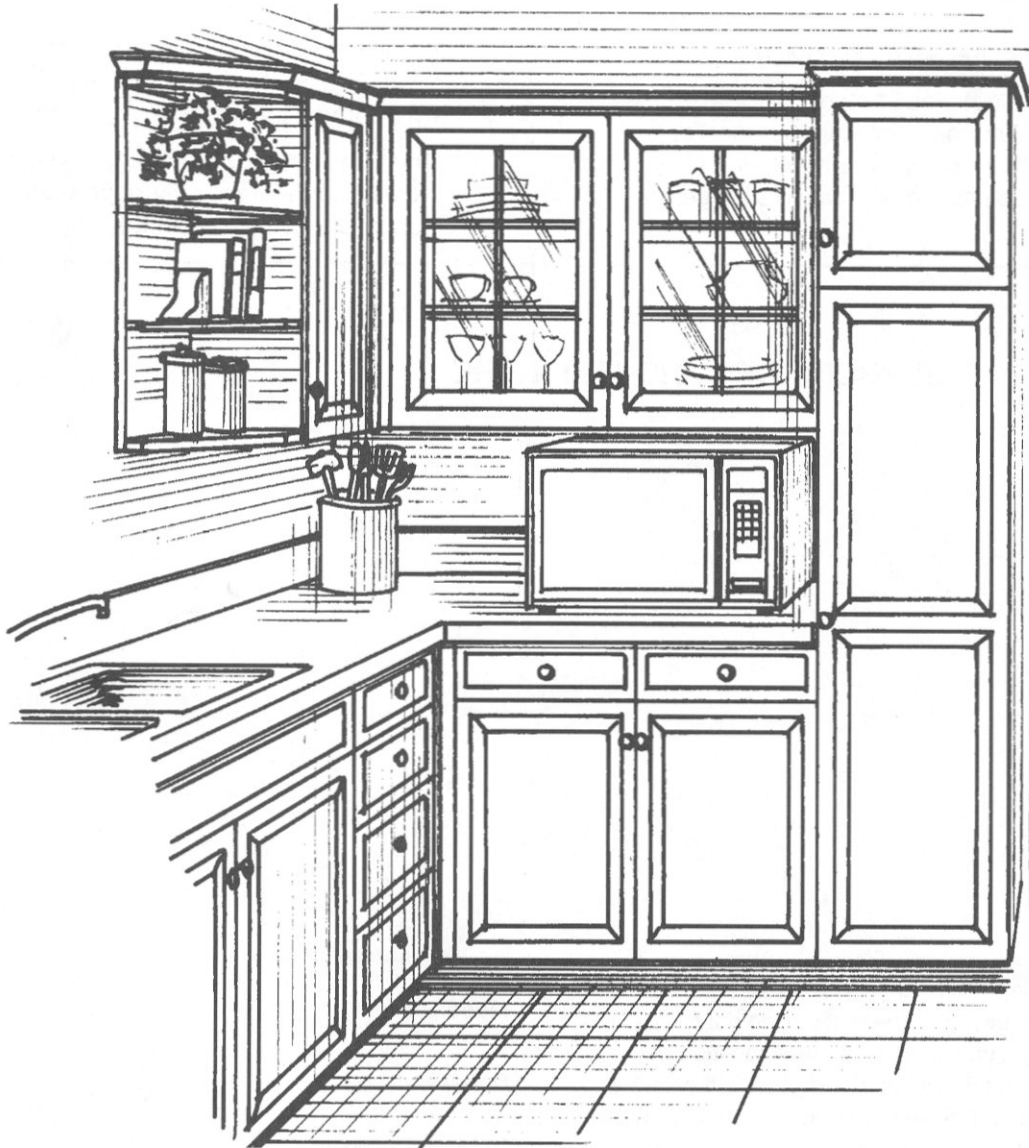

Before operating this oven, please read these instructions completely.

This manual contains Safety Instructions, Operating Instructions and Maintenance of the Oven.  
See Quick Guide on back cover.

**SAVE THIS MANUAL FOR FURTHER REFERENCE.**

*Thank you for purchasing the Quasar Microwave Oven*

## **PRECAUTIONS TO AVOID POSSIBLE EXPOSURE TO EXCESSIVE MICROWAVE ENERGY**

- (a) Do not attempt to operate this oven with the door open since open-door operation can result in harmful exposure to microwave energy. It is important to not defeat or tamper with the safety interlocks.
- (b) Do not place any object between the oven front face and the door, or allow soil or cleaner residue to accumulate on sealing surfaces.
- (c) Do not operate the oven if it is damaged. It is particularly important that the oven door close properly and that there is no damage to the:
  - (1) door (bent)
  - (2) hinges and latches (broken or loosened)
  - (3) door seals and sealing surfaces
- (d) The oven should not be adjusted or repaired by anyone except properly qualified service personnel.

**STAPLE YOUR PROOF OF PURCHASE HERE**

The serial number of this product may be found on the right side of the oven door opening. You should note the model number and the serial number of this oven in the space provided and retain this book as a permanent record of your purchase for future reference.

**Model No** \_\_\_\_\_

**Serial No** \_\_\_\_\_

**Date of Purchase** \_\_\_\_\_

# TABLE OF CONTENTS

## Before Operation

Precautions for Microwave Energy .....	Inside Front Cover
Important Safety Instructions .....	2
Installation Instructions .....	3
Grounding Instructions .....	3
Practical Hints .....	4
Cookware and Utensil Guide.....	5
Food Characteristics.....	6
Cooking Techniques.....	6
Feature Diagram .....	7
Control Panel .....	7

## Operation

Weight Conversion (oz/lb or g/kg) .....	8
Clock Setting .....	8
Child Safety Lock .....	8
Power & Time Setting .....	8
Auto Cooking Pads .....	9
Auto Defrost.....	10
Auto Reheat .....	10
Timer Setting/Stand Time/Delay Start .....	11
Microwave Shortcuts .....	12

## Maintenance

Before Requesting Service.....	13
Care of Your Microwave Oven .....	13
Technical Specifications .....	1
Quick Guide to Operation .....	Back Cover

## Technical Specifications

	MQS0660
Power Consumption:	8.9 Amps, 1000 W
Output:*	600 W
Outside Dimensions (H x W x D):	11 $\frac{1}{2}$ " x 18" x 12 $\frac{1}{2}$ "
Oven Cavity Dimensions (H x W x D):	7 $\frac{1}{2}$ " x 11 $\frac{1}{4}$ " x 11 $\frac{1}{8}$ "
Operating Frequency:	2,450MHz
Uncrated Weight:	Approx. 28 lbs.

\*IEC 705-88 Test procedure  
Specifications subject to change without notice.

# IMPORTANT SAFETY INSTRUCTIONS

Your microwave oven is a cooking device and you should use as much care as you use with a stove or any other cooking device

When using this electric appliance, basic safety precautions should be followed, including the following

**WARNING**—To reduce the risk of burns, electric shock, fire, injury to persons or exposure to excessive microwave energy

- 1 Read all instructions before using the appliance
- 2 Read and follow the specific “**PRECAUTIONS TO AVOID POSSIBLE EXPOSURE TO EXCESSIVE MICROWAVE ENERGY,**” found on back of the front cover
- 3 This appliance must be grounded. Connect only to properly grounded outlet. See “**GROUNDING INSTRUCTIONS**” found on page 3
- 4 Install or locate this appliance only in accordance with the installation instructions on page 3
- 5 Some products such as whole eggs and sealed containers—for example, closed glass jars—may explode and should not be heated in this oven
- 6 Use this appliance only for its intended use as described in this manual. Do not use corrosive chemicals or vapors in this appliance. This type of oven is specifically designed to heat or cook food. It is not designed for industrial or laboratory use
- 7 **Do not allow children to use this appliance, unless closely supervised by an adult**
- 8 Do not operate this appliance if it has a damaged cord or plug, if it is not working properly, or if it has been damaged or dropped
- 9 This appliance should be serviced only by qualified service personnel. Contact the nearest authorized service facility for examination, repair or adjustment
- 10 Do not cover or block any openings on this appliance
- 11 Do not store or use this appliance outdoors. Do not use this product near water—for example, near a kitchen sink, in a wet basement, or near a swimming pool, etc
- 12 Do not immerse the cord or plug in water
- 13 Keep the cord away from heated surfaces
- 14 Do not let the cord hang over the edge of a table or counter
- 15 When cleaning surfaces of the door and oven that come together on closing the door, use only mild, non-abrasive soaps or detergents applied with a sponge or soft cloth
- 16 To reduce the risk of fire in the oven cavity
  - (a) Do not overcook food. Carefully attend the

appliance if paper, plastic, or other combustible materials are placed inside the oven to facilitate cooking

- (b) Remove wire twist-ties from paper or plastic bags before placing the bag in the oven
- (c) If materials inside the oven should ignite, keep the oven door closed, turn the oven off, and disconnect the power cord, or shut off the power at the fuse or circuit breaker panel
- (d) Do not use the cavity for storage purposes. Do not leave paper products, cooking utensils, or food in the cavity when not in use

## General Use

- 1 **DO NOT** tamper with or make any adjustments or repairs to door, control panel housing, safety interlock switches or any other part of the oven. **DO NOT** remove outer panel from oven. Repairs should only be done by a qualified service person
- 2 **DO NOT** operate the oven empty. The microwave energy will reflect continuously throughout the oven causing overheating, if no food or water is present to absorb energy. This could damage the oven and result in the danger of fire
- 3 **DO NOT** use this oven to heat chemicals or any other non-food products. **DO NOT** clean this oven with any product that is labeled as containing corrosive chemicals. The heating of corrosive chemicals in the oven can cause radiation leaks
- 4 **DO NOT** dry clothes, newspapers or other materials in oven. They may catch on fire
- 5 **DO NOT** use recycled paper products unless the paper product is labeled as safe for microwave oven use. Recycled paper products may contain impurities which may cause sparks and/or fires when used
- 6 **DO NOT** use newspapers or paper bags for cooking. Fire can result
- 7 **DO NOT** hit or strike control panel. Damage to controls may occur. Fire can result
- 8 **DO NOT** store flammable materials next to, on top of, or in the oven. These could be fire hazards
- 9 **POT HOLDERS** should always be used when removing items from the oven. Heat is transferred from the HOT food to the cooking container and from the cooking container to the glass tray. The glass tray can be very HOT after removing a cooking container from the oven

## SAVE THESE INSTRUCTIONS

For proper use of your oven, read remaining safety cautions and operation instructions

# INSTALLATION AND GROUNDING INSTRUCTIONS

## Examine Your Oven

Unpack oven, remove all packing material, and examine the oven for any damage such as dents, broken door latches or cracks in the door. Notify the dealer immediately if oven is damaged. **DO NOT** install if the oven is damaged.

## Placement of Oven

1. Oven must be placed on a flat, stable surface. For proper operation, the oven must have sufficient air flow. Allow 3 inches (8 cm) of space on both sides of the oven and 1 inch (2.5 cm) of space on top of oven.
  - a. **DO NOT** block air vents.  
If they are blocked during operation, the oven may overheat. If the oven overheats, a thermal safety device will turn the oven off. The oven will remain inoperable until it has cooled.
  - b. **DO NOT** place oven near a hot damp surface such as a gas or electric range.
  - c. **DO NOT** operate oven when room humidity is too high.
2. This oven was manufactured for household use only.

## Grounding Instructions

This appliance must be grounded. In the event of an electrical short circuit, grounding reduces the risk of electric shock by providing an escape wire for the electric current. This appliance is equipped with a cord having a grounding wire with a grounding plug. The plug must be plugged into an outlet that is properly installed and grounded.

**WARNING** — Improper use of the grounding plug can result in a risk of electric shock. Consult a qualified electrician or service person if the grounding instructions are not completely understood, or if doubt exists as to whether the appliance is properly grounded.

If it is necessary to use an extension cord, use only a three wire extension cord that has a third blade grounding plug, and a three slot receptacle that will accept the plug on the appliance. The marked rating of the extension cord should be equal to or greater than the electrical rating of the appliance.

## Radio Interference

1. Operation of the microwave oven may cause interference to your radio, TV or similar equipment.
2. When there is interference, it may be reduced or eliminated by taking the following measures:
  - a. Clean door and sealing surface of the oven.  
(See Care of Your Microwave Oven found on page 13)
  - b. Place the radio, TV, etc. away from the microwave oven as far as possible.
  - c. Use a properly installed antenna to obtain stronger signal reception.

## Wiring Requirements

1. The oven must be on a **SEPARATE CIRCUIT**. No other appliance should share the circuit with the microwave oven. If it does, the branch circuit fuse may blow or the circuit breaker may trip, or the food may cook slower than times recommended in this manual.
2. The **VOLTAGE** used must be the same as specified on this microwave oven (120 V). Using a higher voltage is dangerous and may result in a fire or other accident causing oven damage. Using a lower voltage will cause slow cooking. Quasar is **NOT** responsible for damage resulting from the use of the oven with other than specified voltage.
3. The oven must be plugged into at least a **15 AMP, 120 VOLT, 60 Hz GROUNDED OUTLET**. Where a standard two-prong outlet is encountered, it is the personal responsibility and obligation of the consumer to have it replaced with a properly grounded three-prong outlet.



4. **TEMPORARY CONNECTIONS** with a two prong adaptor may be made where **LOCAL CODES PERMIT** it. Unless the cover screw is grounded through the house wiring, attaching the adaptor grounding plate to the cover screw will not ground the oven. If there is any doubt that the cover screw is grounded, have it checked by an electrician.



## Power Supply

1. A short power-supply cord is provided to reduce the risks resulting from becoming entangled in or tripping over a longer cord.
2. Longer cord sets or extension cords are available and may be used if care is exercised in their use.
3. If a long cord or extension cord is used, (1) the marked electrical rating of the cord set or extension cord should be at least as great as the electrical rating of the appliance, (2) the extension cord must be a grounding-type 3-wire cord, and (3) the longer cord should be arranged so that it will not drape over the countertop or tabletop where it can be pulled on by children or tripped over accidentally.

## Practical Hints

### Follow These Safety Precautions When Cooking in Your Oven

#### 1) HOME CANNING / DRYING FOODS / SMALL QUANTITIES OF FOODS

- **Do not** use your oven for home canning or the heating of any closed jar. Pressure will build up and the jar may explode. Your oven cannot maintain the food at the proper canning temperature. Improperly canned food may spoil and be dangerous to consume.
- Small quantities of food or foods with low moisture content can dry out, burn or catch on fire.
- **Do not** dry meats, herbs, fruits or vegetables in your oven.

#### IMPORTANT

Proper cooking depends on time set and weight of food. If you use a smaller portion than recommended and cook at the time for the recommended portion, fire can result.

If a fire occurs, turn the oven off and leave the oven door closed. Disconnect the power cord or shut off power at the fuse or circuit breaker panel.

#### 2) POPCORN

Popcorn must be popped in a microwave oven corn popper. Microwave popcorn which pops in its own package is also available. Follow popcorn manufacturers' directions and use a brand suitable for the wattage of your microwave oven. **This oven is rated at 600 W.** Never leave oven unattended when popping popcorn. Allow the popcorn bag to cool before opening it. To prevent steam burns, always open the bag away from your face and body.

#### CAUTION:

**When using pre-packaged microwave popcorn, follow recommended package instructions. If these instructions are not followed, the popcorn may not pop adequately or may ignite and cause a fire.**

#### 3) DEEP FAT FRYING

- **Do not** attempt to deep fat fry in your microwave oven. Cooking oils may burst into flames and may cause damage to the oven and perhaps result in burns. Microwave utensils may not be able to withstand the temperature of the hot oil, and could shatter.

#### 4) EGGS

- **Do not** heat eggs in their shell in a microwave oven. Pressure will build up and the eggs will explode.

#### 5) FOODS WITH NONPOROUS SKINS

- **Potatoes, apples, egg yolks, whole squash and sausages are examples of foods with nonporous skins.** These types of foods must be pierced before microwave cooking to prevent their bursting.
- Use fresh potatoes for baking and cook until just done. Overcooking causes dehydration and may cause a fire. Use recommended weights or fire may occur.

#### 6) LIQUIDS

- Heated liquids can erupt if not mixed with air. **Do not** heat liquids in your microwave oven without first stirring. Stir after heating.

#### 7) GLASS TRAY / COOKING UTENSILS / FOIL

- Cooking utensils get hot during microwaving. Use potholders when removing utensils from the oven or when removing lids or plastic wrap covers from cooking utensils to avoid burns.
- The glass tray will get hot during cooking. It should be allowed to cool before handling or before paper products, such as paper plates or microwave popcorn bags, are placed in the oven for microwave cooking.
- When using foil, skewers, warming rack or utensils made of metal in the oven, allow at least 1-inch (2.5 mm) of space between metal material and interior oven walls. If arcing occurs (sparking), remove metal material (skewers etc.) and/or transfer to a non-metallic container.
- Dishes with metallic trim should **not** be used, as arcing may occur.

#### 8) PAPER TOWELS / CLOTHS

- **Do not** use paper towels or cloths which contain a synthetic fiber woven into them. The synthetic fiber may cause the towel to ignite.
- **Do not** use paper bags or recycled paper products in the microwave oven.

#### 9) BROWNING DISHES / OVEN COOKING BAGS

- Browning dishes or grills are designed for microwave cooking only. Always follow instructions provided by the manufacturer. Do not preheat browning dish more than 8 minutes.
- If an oven cooking bag is used for microwave cooking, prepare according to package directions. Do not use a wire twist-tie to close bag.

#### 10) THERMOMETERS

- **Do not** use a conventional meat thermometer in your oven. Arcing may occur.

#### 11) BABY FORMULA / FOOD

- **Do not** heat baby formula or food in the microwave oven. The glass jar or surface of the food may appear warm while the interior can burn the infant's mouth and esophagus.

#### 12) REHEATING PASTRY PRODUCTS

- When reheating pastry products, check temperature of any fillings before eating. Some foods have fillings which heat faster and can be extremely hot while the surface remains warm to the touch (ex. jelly donuts).

#### 13) GENERAL OVEN USAGE GUIDELINES

- **Do not** use the oven for any reason other than the preparation of food.
- **Do not** leave oven unattended while in use.

## Cookware and Utensil Guide

ITEM	MICROWAVE	COMMENTS
Aluminum Foil	Yes for Shielding only	Small strips of foil can be molded around thin parts of meat or poultry to prevent overcooking. Arcing can occur if foil is too close to oven wall or if too much foil is used.
Browning Dish	Yes	Browning dishes are designed for microwave cooking only. Check browning dish information for instructions and heating chart. Do not preheat for more than 8 minutes.
Brown paper bags	No	May cause a fire in the oven.
Dinnerware Microwave-Safe only	Yes	Check manufacturers' use and care directions for suitability for microwave heating. Some dinnerware may state on the back of the dish, "Oven-Microwave Proof."
Disposable polyester Paperboard Dishes	Yes	Some frozen foods are packaged in these dishes. Can be purchased in grocery stores.
Fast Food Carton with Metal Handle	No	May cause arcing.
Frozen Dinner Tray Metal	Yes	Frozen dinners may be heated in foil tray, if tray is less than ¾-inch (2 cm) high. Place foil tray in center of oven. Leave at least 1-inch (2.5 cm) space between foil tray and oven walls. Heat only 1 foil tray in the oven at a time. For containers more than ¾-inch (2 cm) deep, remove food and place in a similar size microwave-safe container.
Microwave-safe	Yes	
Glass Jars	Yes	Remove lid. Heat food until just warm. Most glass jars are not heat resistant.
Glassware Heat Resistant Oven Glassware and Ceramic, only	Yes	Ideal for microwave cooking and browning. If in doubt, use the container test listed below.
Metal Twist Ties	No	They may cause arcing which could cause a fire in the oven.
Oven Cooking Bag	Yes	Follow manufacturers' directions. Close bag with the nylon tie provided, a strip cut from the end of the bag, or a piece of cotton string. Do not close with metal twist tie. Make six ½-inch (1 cm) slits by closure.
Paper Plates & Napkins	Yes	Use to warm cooked foods, and to cook foods that require short cooking times such as hot dogs.
Paper Towels & Napkins	Yes	Use to warm rolls and sandwiches by microwave.
Plastic Microwave-Safe only Cookware and Storage Dishes	Yes	Should be labeled, "Suitable for microwave heating." Check manufacturers' directions for recommended uses. Some microwave-safe plastic dishes are not suitable for cooking foods with high fat content.
Plastic Foam Cups	Yes	Plastic foam will melt if foods reach a high temperature. Use to bring foods to a low serving temperature.
Plastic Wrap	Yes	Use to cover food during cooking to retain moisture.
Straw, Wicker, Wood	Yes	Use only for short term reheating. Use to bring foods to a low serving temperature.
Thermometers Microwave-safe only	Yes	Use only microwave-safe meat and candy thermometers.
Conventional	No	Not suitable for use in microwave oven.
Wax paper	Yes	Use as a cover to prevent spattering and to retain moisture.

**TO TEST A CONTAINER FOR SAFE MICROWAVE OVEN USE:** Fill a 1 -cup glass measure with water and place it in the microwave oven along with the container to be tested; **heat one minute at HIGH**. If the container is microwave oven-safe, the empty container should remain comfortably cool and the water should be hot. If the container is hot, it has absorbed some microwave energy and should not be used. This test cannot be used for plastic containers.



## Food Characteristics

---

**Bone and Fat:** Both bone and fat affect cooking. Bones may cause irregular cooking. Meat next to the tips of bones may overcook while meat positioned under a large bone, such as a ham bone, may be undercooked. Large amounts of fat absorb microwave energy and the meat next to these areas may overcook.

**Density:** Porous, airy foods such as breads, cakes or rolls take less time to cook than heavy, dense foods such as potatoes and roasts.

**Quantity:** Two potatoes take longer to cook than one potato. As the quantity of the food increases so does the cooking time.

When cooking small amounts of food such as one

or two potatoes, do not leave oven unattended. The moisture content in the food may decrease and a fire could result.

**Shape:** Uniform sizes heat more evenly. The thin end of a drumstick will cook more quickly than the meaty end. To compensate for irregular shapes, place thin parts toward the center of the dish and thick parts toward the edge.

**Size:** Thin pieces cook more quickly than thick pieces.

**Starting Temperature:** Foods that are room temperature take less time to cook than if they are refrigerator temperature or frozen.

## Cooking Techniques

---

**Spacing:** Individual foods, such as baked potatoes, cupcakes and appetizers, will cook more evenly if placed in the oven equal distances apart. When possible, arrange foods in a circular pattern.

**Browning:** Foods will not have the same brown appearance as conventionally cooked foods. Meats and poultry may be coated with browning sauce, Worcestershire sauce, barbecue sauce or shake-on browning sauce. To use, combine browning sauce with melted butter or margarine; brush on before cooking.

**Piercing:** Foods with skins or membranes must be pierced, scored or have a strip of skin peeled before cooking to allow steam to escape. Pierce whole egg yolks and whites, clams, oysters, chicken livers, scallops, whole potatoes and whole vegetables. Whole apples or new potatoes should have a 1-inch strip of skin peeled before cooking. Score sausage, frankfurters and hot dogs.

**Covering:** As with conventional cooking, moisture evaporates during microwave cooking. Casserole lids or plastic wrap are used for a tighter seal. When using plastic wrap, vent the plastic wrap by folding back part of the plastic wrap from the edge of the dish to allow steam to escape. Loosen or remove plastic wrap as recipe directs for stand time. When removing plastic wrap covers, as well as any glass lids, be careful to remove them away from you to avoid steam burns. Various degrees of moisture retention are also obtained by using wax paper or paper towels. However, unless specified, a recipe is cooked uncovered.

**Shielding:** Thin areas of meat and poultry cook more quickly than meaty portions. To prevent overcooking, these thin areas can be shielded with strips of aluminum foil. Wooden toothpicks may be used to hold the foil in place.

**Timing:** A range in cooking time is given in each recipe. The time range compensates for the uncontrollable differences in food shapes, starting temperature and regional preferences. Always cook food for the minimum cooking time given in the recipe and check for doneness. If the food is undercooked, continue cooking. It is easier to add time to an undercooked product. Once the food is overcooked, nothing can be done.

**Stirring:** Stirring is usually necessary during microwave cooking. We have noted when stirring is helpful, using the words once, twice, frequently or occasionally to describe the amount of stirring necessary.

**Rearranging:** Rearrange small items such as chicken pieces, shrimp, hamburger patties or pork chops. Rearrange pieces from the edge to the center and pieces from the center to the edge of the dish.

**Turning:** It is not possible to stir some foods to redistribute the heat. At times microwave energy will concentrate in one area of a food. To help insure even cooking, these foods need to be turned. Turn over large foods, such as roasts or turkeys, halfway through cooking.

**Stand Time:** Most foods will continue to cook by conduction after the microwave oven is turned off. In meat cookery, the internal temperature will rise 5°F to 15°F if allowed to stand, tented with foil, for 10 to 15 minutes. Casseroles and vegetables need a shorter amount of standing time, but this standing time is necessary to allow foods to complete cooking in the center without overcooking on the edges.

**Testing for Doneness:** The same tests for doneness used in conventional cooking may be used for microwave cooking. Meat is done when fork-tender or splits at fibers. Chicken is done when juices are clear yellow and drumstick moves freely. Fish is done when it flakes and is opaque.

## FEATURE DIAGRAM

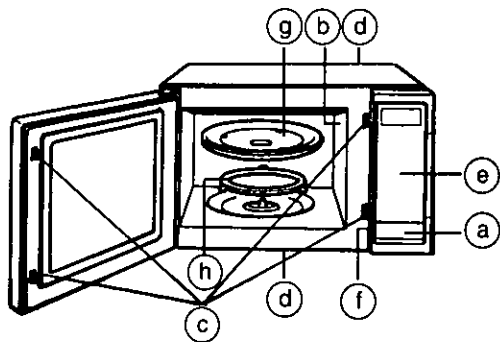

- (a) Door Release Button
- (b) Internal Air Vents
- (c) Door Safety Lock System
- (d) External Air Vents
- (e) Control Panel
- (f) Identification Plate
- (g) Glass Tray
- (h) Roller Ring

## CONTROL PANEL

MQS0660

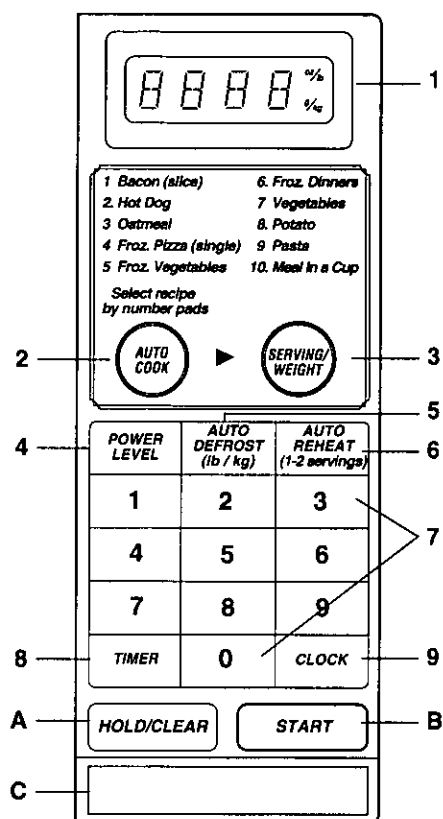

- 1) Display Window
- 2) **AUTO COOK** Pad
- 3) **SERVING/WEIGHT** Pad
- 4) **POWER LEVEL** Pad
- 5) **AUTO DEFROST** Pad
- 6) **AUTO REHEAT** Pad
- 7) Number Pads
- 8) **TIMER** Pad
- 9) **CLOCK** Pad
- A) **HOLD/CLEAR** Pad

Before cooking One tap clears your instruction  
 During cooking One tap temporarily stops the cooking process A second tap cancels all your instructions and the time of day or dot appears on the screen

### B) **START** Pad

One tap allows oven to begin functioning If door is opened or **HOLD/CLEAR** Pad is pressed once during oven operation, **START** Pad must be pressed again to restart oven

### C) Door Release Button

Just press it to open the door If the door is opened during the cooking process, the cooking process will pause Cooking will resume as soon as the door is closed and the **START** Pad is pressed The oven light will stay on or will turn on whenever the door is opened







### Beep Sound

When a pad is pressed correctly, a beep will be heard If a pad is pressed and no beep is heard, the unit did not or cannot accept the instruction The oven will beep twice between programmed stages At the end of any completed program, the oven will beep 5 times

## Conversion

The oven automatically displays weight in imperial. If you wish to use metric system, press **START** Pad once directly after plugging the oven in, the indicator shows g/kg. The indicator will show oz/lb or g/kg when you have to set the weight (e.g., after pressing **AUTO DEFROST** Pad).

## Clock Setting

Example To set 11:25	
1. 	• Press ➤ Dot blinks
2.    	• Enter time of day using the number pads ➤ Time appears in the Display Window, dot is blinking
3. 	• Press ➤ Dot stops blinking, time of day is entered and locked into Display Window

### NOTE

- 1 You can use the oven without setting the clock
- 2 There is no a.m. or p.m. settings. Clock is a 12-hour display
- 3 To reset time of day, repeat the steps above
- 4 The clock will retain time setting only when plugged into power source
- 5 Oven will not operate while dot is blinking

## Child Safety Lock

This feature allows the prevention of use by children (not including door mechanism). You can set **Child Lock** when the Display Window shows a dot or time of day.

### To Set

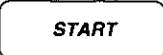
1. 	• Press 3 times ➤ "CHILD" appears in the Display Window
----------------------------------------------------------------------------------------	------------------------------------------------------------



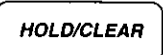

### To Cancel

1. 	• Press 3 times ➤ Dot or time of day reappears in the Display Window
----------------------------------------------------------------------------------------	-------------------------------------------------------------------------

## Power & Time Setting

How do I program power and time?

**Example: To cook at MEDIUM Power for 5 minutes**

1.  4 times = Medium	• Select power level (according to the chart below)
2.    5 00	• Set cooking time using number pads (up to 99 minutes and 99 seconds for a single stage)
3. 	• Press <b>START</b> ➤ Cooking will start The time in the Display Window will begin to count down <b>To recall</b> the selected power level during cooking, press <b>POWER LEVEL</b> Pad

### NOTE





- 1 For 2 or 3 stage cooking, repeat steps 1 and 2 above before pressing **START** Pad
- 2 When selecting HIGH power, you can start from step 2

Press	Power Level	% Power
once	P 100 HIGH	100%
twice	dEF DEFROST	30%
3 times	P 70 MEDIUM-HIGH	70%
4 times	P 50 MEDIUM	50%
5 times	P 30 MEDIUM-LOW	30%
6 times	P 10 LOW	10%

# Auto Cooking

This feature gives you the convenience of utilizing preset microwave settings for these food categories. All you need to do is select the food category and quantity. Then touch **START**. It's that simple. (If your food is slightly different from those listed, you will want to use your own setting (see page 8 for Power & Time Settings))







## ex To Cook 2 Hot Dogs

1.		• Press <b>AUTO COOK</b>
2.		• Use the number pads to select recipe (e.g. Hot dog is 2)
3.		• Press <b>SERVING/WEIGHT</b> to select correct number of servings (according to the chart below)
4.		• Press <b>START</b> ➤Cooking time will appear in the Display Window and begin to count down

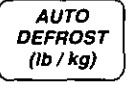
CATEGORY	SERVING/WEIGHT	HINTS
1 Bacon	2,3,4 slices	Place slices of bacon on a microwaveable rack and cover with waxed paper or paper towel
2 Hot Dog	1,2,3 pieces	Pierce Skin. Watch carefully
3 Oatmeal	1,2,3 servings	Following manufacturers' directions for amount of liquid, covering or stirring. Use large container to prevent boil over
4 Froz Pizza (single)	4, 8 oz (115, 225 g)	Follow manufacturers' directions for covering or removing covers. For best results, do not use frozen foods packaged in foil trays. Halfway through cooking, rearrange or stir.
5 Frozen Vegetables	5, 10, 16 oz (150, 300, 450 g)	
6 Frozen Dinners	11, 15 oz (300, 430 g)	
7 Vegetables	4, 8, 12 oz (110, 300, 450g)	Cover with lid or plastic wrap. Add from 2 tbsp to 1/4 cup of water. Stir occasionally during cooking. Let stand, covered, 3-5 minutes before serving.
8 Potato	1,2,3 pieces (6 - 8 oz each)	Potatoes must be pierced several times before cooking. Place on a microwave-safe dish. <b>Do not cover</b>
9 Pasta	2, 4, 6, 8 oz (55, 110, 170, 225 g)	2c water, 1/2t salt, 1/2t oil 3c water, 1/2t salt, 1t oil 4c water, 1/2t salt, 1/2T oil 5c water, 1t salt, 1T oil Place 1 1/2-quarts of water, 1 tbsp oil and 1 tsp salt in a 4 qt casserole. Cover with lid. After beep, add pasta. After cooking, rinse pasta with cold water.
10 Meal in a Cup	7.5 oz 10.5 oz	Follow manufacturers' directions

## Auto Defrost

This feature allows you to defrost meat, poultry and seafood by weight without setting time

Example: To defrost 1 2 lb of meat	
1. 	• Press Weight system will be indicated. Dot blinks
2.  	• Set the weight of the food using the number pads. Weight of the frozen food must be programmed in pounds and tenths of a pound, not ounces. See chart below.  Press  →  for 1 2 lbs
3. 	• Press ▶ Defrosting time appears in the Display Window and begins to count down

### NOTE

- The shape and size of the food will determine the maximum weight the oven can accommodate. The recommended **maximum weight of meat is 4 lbs (1 8 kg), poultry, 6 lbs. (2 7 kg) and seafood, 3 lbs (1 4 kg)**
- The oven beeps once during the defrosting cycle to signal that the food needs to be **turned or rearranged**. To prevent overdefrosting, thin areas or edges can be shielded with strips of aluminum foil.
- For best results, the minimum recommended weight is **0 5 lb (220 g)**.
- Stand time or power level may be programmed after Auto Defrost.



### Conversion Chart

Follow this chart to convert ounces or hundredths of a pound into tenths of a pound. If a piece of meat weighs 1 95 pounds or 1 pound 14 ounces, program 1 9 pounds.

Ounces	Hundredths of a Pound	Tenths of a Pound
0	96 - 05	0 0
1 - 2	06 - 15	0 1
3 - 4	16 - 25	0 2
5	26 - 35	0 3
6 - 7	36 - 45	0 4
8	46 - 55	0 5
9 - 10	56 - 65	0 6
11 - 12	66 - 75	0 7
13	76 - 85	0 8
14 - 15	86 - 95	0 9

## Auto Reheat

This feature allows you to reheat 1 to 2 servings of precooked room temperature and refrigerator temperature foods without setting power and time.

Example: To reheat 2 cups of soup	
1.  twice	• Press until the desired number of servings appears in the Display Window
2. 	• Press ▶ Time appears in the Display Window and begins to count down

### NOTE

- Auto Reheat can be programmed for 1 to 2 servings.
- The recommended food items and approximate weights are listed in the chart below.

Foods	Number of Servings	Serving Size	Starting Temp
Plate of Food	1	12 - 16 oz	Refrig
Meat, Poultry	1 - 2	4 - 6 oz	Refrig
Casseroles	1 - 2	8 oz	Refrig
Side Dishes	1 - 2	4 - 6 oz	Refrig or Room
Soups, Sauces, Gravy	1 - 2	6 - 8 oz	Refrig or Room



### For best results follow these recommendations

- All foods must be previously cooked.
- Foods should always be covered loosely with plastic wrap, wax paper or casserole lid.
- All foods should have a covered stand time of 3 to 5 minutes.
- DO NOT** reheat bread and pastry products. Use manual power and time.
- DO NOT** reheat beverages.



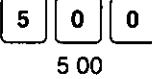

## Timer Setting

This feature allows you to program a Stand Time after cooking is completed and to program the oven as Minute Timer and/or to program Delay Start



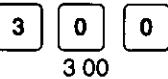

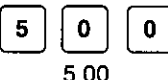
### To Use as a Kitchen Timer:

Example To count 5 minutes	
1. 	• Press
2.  5 00	• Set desired amount of time using the number pads (up to 99 minutes and 99 seconds)
3. 	• Press ▶ Time will count down without oven operating

### To Set Stand Time:

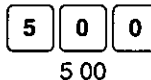
Example: To stand for 5 minutes after cooking (3 mins at MEDIUM Power)	
1.  4 times ↓  3 00	• Set the desired cooking program (see page 8 "Power & Time Setting")
2. 	• Press
3.  5 00	• Set desired amount of Stand Time using the number pads (up to 99 minutes and 99 seconds)
4. 	• Press ▶ Cooking will start After cooking, stand time will count down without oven operating

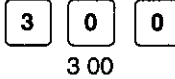
### To Set Delay Start:

Example To delay the start of cooking 5 minutes before setting the cooking program of MED for 3 minutes.	
1. 	• Press
2.  5 00	• Set desired amount of delayed time using the number pads (up to 99 minutes and 99 seconds)
3.  Med = 4 times ↓  3 00	• Set the desired cooking program (see page 8 for directions)
4. 	• Press ▶ Delayed time will count down Then cooking will start

#### NOTES:

- 1 If oven door is opened during the Stand Time or Kitchen Timer, the time on the screen will continue to count down
- 2 Delay Start cannot be programmed before any Auto Control Function  
This is to prevent the starting temperature of the food from rising before defrosting or cooking begins. A change in the starting temperature could cause inaccurate cooking results

## Microwave Shortcuts

FOOD	POWER	TIME (In minutes)	DIRECTIONS
<b>Butter, Melted</b> , ¼ pound <b>Butter, Softened</b> , ¼ pound	<b>LOW</b> <b>MEDIUM-LOW</b>	1 - 2 ½ - 1	Remove wrapper and place butter in a microwave-safe dish
<b>Chocolate, Melted</b> , 1 square (1 oz ) <b>Chocolate, Melted</b> , ½ cup chips	<b>MEDIUM</b> <b>MEDIUM</b>	2 - 3 2 - 3	Remove wrapper and place chocolate in dish. Stir before adding more time. Chocolate holds its shape even when softened.
<b>Bacon, Separated</b> , 1 lb	<b>HIGH</b>	½ - 1	Remove wrapper. After heating, use a plastic spatula to separate slices.
<b>Cream Cheese, Softened</b> , 3 oz	<b>MEDIUM-LOW</b>	½ - 1	Remove wrapper and place in a bowl.
<b>Cup of Water</b> (boiling) 1 cup (8 oz ) 2 cups (16 oz ) <b>Cup of Milk</b> (scalded) 1 cup (8 oz ) 2 cups (16 oz )	<b>HIGH</b> <b>HIGH</b> <b>MED-HIGH</b> <b>MED-HIGH</b>	4 6½ 3½ - 4½ 7 - 8	Heated liquids can erupt if not mixed with air. Do not heat liquids in your microwave oven without stirring first. Stir after heating.
<b>Coconut, Toasted</b> , ½ cup	<b>MED-HIGH</b>	1 - 3	Place in a pie plate or bowl. Stir every 30 seconds.
<b>Ground Beef, Browned</b> , 1 lb	<b>HIGH</b>	3 - 5	Crumble in microwave-safe colander set in another dish. Stir twice.
<b>Ice Cream, Softened</b> , ½ gallon	<b>MEDIUM-LOW</b>	3 - 4	—————
<b>Nuts, Roasted</b> , ½ cup	<b>HIGH</b>	3 - 5	Spread nuts in 9-inch pie plate. Stir twice.
<b>Sesame Seeds, Toasted</b> , ¼ cup	<b>HIGH</b>	2½ - 4	Place in a small bowl. Stir twice.
<b>Brown sugar, Softened</b>	<b>HIGH</b>	½ - ¾	Place 1 cup hard brown sugar in dish with a slice of bread or a wedge of apple. Cover with plastic wrap.
<b>To Remove Oven Odors</b>	<b>HIGH</b>	5	Combine 1 to 1½ cups of water with the juice and peel of one lemon in a small bowl. After heating, wipe interior of oven with damp cloth. Repeat as needed.

# Care of Your Microwave Oven

**BEFORE CLEANING.** Unplug oven at socket of the wall outlet. If impossible, leave oven door open to prevent oven from accidentally turning on.

**Inside of the oven.** Wipe with a damp cloth. Mild detergent may be used if the oven gets very dirty. The use of harsh detergent or abrasives is not recommended.

**Outside oven surfaces.** Clean with a damp cloth. To prevent damage to the operating parts inside the oven, water should not be allowed to seep into ventilation openings.

**Control Panel:** If it becomes wet, clean with a soft, dry cloth. **DO NOT** use harsh detergents or abrasives on the Control Panel.

**Glass Tray:** Remove and wash in warm sudsy water or in a dishwasher.

**Oven Door:** Wipe with a soft cloth when steam accumulates inside or around the outside of the

oven door. During cooking, especially under high humidity conditions, steam is given off from the food. (Some steam will condense on cooler surfaces, such as the oven door.) This is normal.

**The Roller Ring and oven cavity floor.** Wipe the bottom surface of the oven with mild detergent water or window cleaner and dry. The roller ring may be washed in mild sudsy water or dishwasher. These areas should be kept clean to avoid excessive noise.

**STEAM CONDENSATION** can cause the inside of the oven and the oven door to rust. To prevent this, those places must be wiped with a dry cloth to remove any remaining water after oven use.

**AFTER CLEANING:** Be sure to replace the Roller Ring and Glass Tray in the proper position and press **HOLD/CLEAR** Pad to clear the screen.

## Before Requesting Service

### All these are normal:

The oven causes interference with my TV

Some radio and TV interference might occur when you cook with the microwave oven. This interference is similar to the interference caused by small appliances such as mixers, vacuums, blow dryers, etc. It does not indicate a problem with your oven.

The oven lights dim

When cooking with a power other than HIGH, the oven must cycle on/off to obtain the lower power levels. The oven light will dim and clicking noises can be heard when the oven cycles. This is a normal operation.

Steam accumulates on the oven door and warm air comes from the oven vents

During cooking, steam and warm air are given off from the food. Most of the steam and warm air are removed from the oven by the air which circulates in the oven cavity. However, some steam will condense on cooler surfaces such as the oven door. This is normal.

I accidentally ran my microwave oven without any food in it

Running the oven empty for a short time will not damage the oven. However, we do not recommend operating the oven in this manner.

### PROBLEM

### POSSIBLE CAUSE

### REMEDY

Oven will not turn on



The oven is not plugged in securely

Remove plug from outlet, wait 10 seconds and reinsert

Circuit breaker or fuse is tripped or blown

Reset circuit breaker or replace fuse

There is a problem with the outlet

Plug another appliance into the outlet to check if it is working

Oven will not start cooking



The door is not closed completely

Close the oven door securely

Another program entered already in the oven

Press **HOLD/CLEAR** Pad to cancel the previous program and program again

When the oven is turning on, there is a noise coming from the glass tray







The roller ring and oven bottom are dirty

Clean these parts according to "Care of Your Microwave Oven" above

If it seems there is a problem with the oven, contact an authorized Servicenter

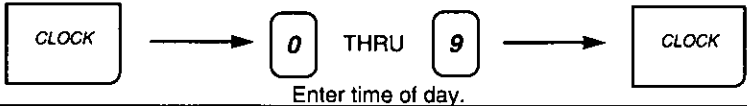
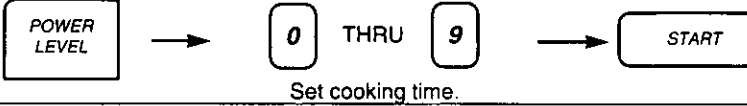
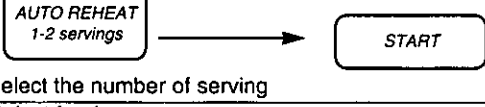

# Quick Guide to Operation

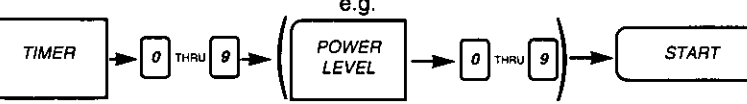
Feature	How to Operate
To Set Clock (page 8)	 <p>CLOCK → 0 THRU 9 → CLOCK Enter time of day.</p>
To Set Power and Time (page 8)	 <p>POWER LEVEL → 0 THRU 9 → START Set cooking time.</p>
To Reheat using "Auto Reheat" Pad (page 10)	 <p>AUTO REHEAT 1-2 servings → START Select the number of serving</p>
To Cook using "Auto Cook" Pads (page 9)	 <p>AUTO COOK → SERVING/WEIGHT → START Select food. e.g.</p>
To Defrost using "Auto Defrost" Pad (page 10)	 <p>AUTO DEFROST lb/kg → 0 THRU 9 → START</p>
To Use as a Kitchen Timer (page 11)	 <p>TIMER → 0 THRU 9 → START</p>
To Set Stand Time (page 11)	 <p>POWER LEVEL → 0 THRU 9 → TIMER → 0 THRU 9 → START Set desired cooking program. e.g.</p>
To Set Delay Start (page 11)	 <p>TIMER → 0 THRU 9 → POWER LEVEL → 0 THRU 9 → START Set desired cooking program. e.g.</p>

# Quasar

Matsushita Consumer Electronics Company  
 Division of Matsushita Electric Corporation of America  
 One Panasonic Way, Secaucus, New Jersey 07094

B00038760AQ

Printed in U.S.A.