

This Owner's Manual is provided and hosted by [Appliance Factory Parts](http://Appliance Factory Parts).

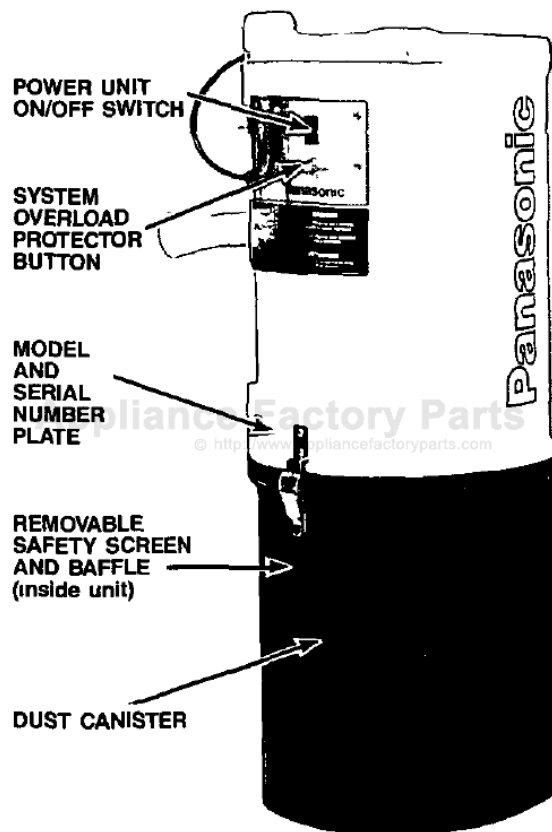

# PANASONIC MC-H1000 Owner's Manual

[Shop genuine replacement parts for PANASONIC  
MC-H1000](#)



[Find Your PANASONIC Vacuum Cleaner Parts - Select From 605 Models](#)

----- Manual continues below -----

# Operating Instructions



## **Panasonic**<sup>TM</sup> BUILT-IN VACUUM CLEANING SYSTEM

Models: MC-H1000  
MC-H2000  
Attachment Kit: MC-H1100

Before operating this unit, please read these instructions completely.

# Contents

Page

<b>BEFORE YOU USE YOUR VACUUM CLEANING SYSTEM</b>	2
<b>GROUNDING INSTRUCTIONS</b>	3
<b>IMPORTANT SAFETY INSTRUCTIONS</b>	4
<b>HOW VACUUM CLEANING SYSTEM WORKS</b>	7
<b>PARTS AND FEATURES</b>	8
<b>ASSEMBLING YOUR VACUUM CLEANING SYSTEM FOR USE</b>	10
<b>USING YOUR VACUUM CLEANING SYSTEM</b>	12
Pile Height Adjustment	13
Attachments	14
For Best Results	17
<b>CARING FOR YOUR VACUUM CLEANING SYSTEM</b>	19
Power Unit	19
Power Nozzle	22
<b>IF YOU NEED SERVICE OR ASSISTANCE</b>	26

## Before you use your vacuum cleaning system

Read the instructions carefully for important use and safety information.

You are personally responsible for:

- Reading and following all safety precautions in this Manual and the "Installation Instructions"
- Having your vacuum cleaning system installed by a qualified installer
- Installing the vacuum cleaning system where it is protected from the elements
- Having your vacuum cleaning system properly connected to the right kind of grounded electrical outlet (See "Installation Instructions")
- Properly assembling the vacuum cleaning system according to the "Installation Instructions" and the directions in this book (See page 10)
- Using the vacuum cleaning system only for jobs normally expected of a home vacuum cleaning system
- Properly maintaining the vacuum cleaning system

# GROUNDING INSTRUCTIONS

Polarized 3-Prong  
Grounding Type  
Outlet

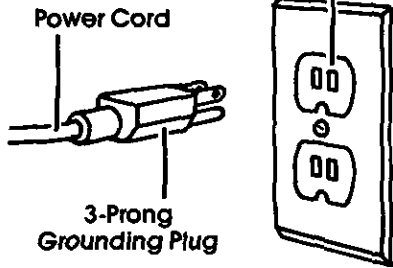

is equipped with a grounding plug as shown above. For your personal safety, the vacuum cleaning system must be grounded. In the event of an electrical short circuit, grounding reduces the risk of electric shock by providing an escape wire for the electrical current. This appliance is equipped with a polarized 3-prong grounding plug. It must be plugged into a correctly polarized mating 3-prong grounding type outlet, properly installed and grounded in accordance with the National Electrical Code and local codes and ordinances.

The vacuum cleaning system is for use on a 120-volt, 60 Hz, AC only 15 ampere fused and properly grounded circuit and

## **! WARNING**

Improper connection of the polarized 3-prong grounding type outlet can result in a risk of electric shock. Check with a qualified electrician or service person if you are in doubt as to whether the outlet is properly grounded. Do not modify the plug provided with the vacuum cleaning system — if it will not fit the outlet, have a proper outlet installed by a qualified electrician.

# IMPORTANT SAFETY INSTRUCTIONS

## ⚠ WARNING

To reduce the risk of fire, electrical shock, injury to persons or damage when using your vacuum cleaner, follow basic safety precautions including the following:

**Read** this manual before assembling or using your vacuum cleaner.

**Use** your cleaner only as described in this manual. Use only with Panasonic recommended attachments.

**Connect** Power Unit to a properly grounded outlet only. See "Grounding Instructions" on page 3.

**Do not** use outdoors or on wet surfaces. Electrical shock could occur.

**Disconnect** Power Unit electrical supply before servicing. Failure to do so could result in electrical shock.

**Disconnect** Power Nozzle electrical supply before servicing or cleaning out brush area. Failure to do so could result in electrical shock or brush suddenly starting.

**Always** turn Power Nozzle off before connecting or disconnecting the hose or Power Nozzle.

**Always** turn Power Nozzle off before unplugging.

**Do not** unplug by pulling on cord. To unplug, grasp the plug, not the cord.

**Do not** use with damaged cord or plug. If Power Nozzle is not working as it

should, has been dropped, damaged, left outdoors, or dropped into water, return it to an authorized Panasonic Service Center.

**Do not** pull or carry by cord, use cord as a handle, close door on cord, or pull cord around sharp edges or corners. Do not run Power Nozzle over cord. Keep cord away from heated surfaces.

**Do not** leave Power Nozzle when plugged in. Unplug from outlet when not in use and before servicing.

**Do not** allow Power Nozzle to be used as a toy. Close attention is necessary when used by or near children.

**Do Not** handle plug or Power Nozzle with wet hands.

**Do not** operate cleaner with a punctured hose. The hose contains electrical wires. Replace if cut or worn. Avoid picking up sharp objects.

**Do not** put any objects into openings.

**Do not** use with any opening blocked; keep free of dust, lint, hair and anything that may reduce air flow.

**Keep** hair, loose clothing, fingers, and all parts of body away from openings and moving parts.

**Do not** use cleaner without filters in place. Always empty the dust canister after vacuuming carpet cleaners or fresheners, powders and fine dust. These products clog the filter and reduce air flow. Failure to clean could cause permanent damage to the cleaner.

**Do not** use the cleaner to pick up sharp objects, small toys, pins, paper, etc. They may damage the cleaner.

**Do not** pick up anything that is burning or smoking, such as cigarettes, matches, or hot ashes.

**Do not** use cleaner to pick up flammable or combustible liquids (gasoline, cleaning fluids, perfumes, etc.), or use in areas where they may be present. The fumes from these substances can create a fire hazard or explosion.

**Use extra care** when cleaning on stairs.

**You** are responsible for making sure that your vacuum cleaner is not used by anyone unable to operate it properly.

## SAVE THESE INSTRUCTIONS

Proper assembly and safe use of your vacuum cleaner are your responsibilities. Your cleaner is intended only for household use. The cleaner should be stored in a dry, indoor area. Read this Manual carefully for important use and safety information.

## Important safety precautions

Read this manual and follow all safety precautions to prevent injury and/or damage to the vacuum cleaning system. When using electrical appliances, basic cautions should be taken including the following:

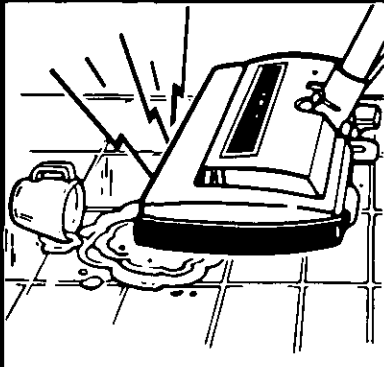

### **! WARNING:**

**ELECTRIC SHOCK  
COULD OCCUR IF  
USED OUTDOORS OR  
ON WET SURFACES.**

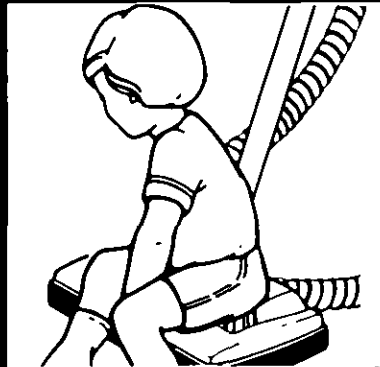

**DO NOT** allow children to play with or ride on any part of the vacuum cleaning system. Injury could result from suction or moving parts. Children should not use the cleaning system unless supervised by an adult.

**DO NOT** operate with punctured hose. It contains electric wires. Shock or fire hazard could result. Replace hose if it is cut or worn.

### **! WARNING:**

**• FOR YOUR SAFETY •  
DISCONNECT ELECTRICAL  
SUPPLY BEFORE SERVICING  
AND/OR CLEANING OUT  
BRUSH AREA AS ELEC-  
TRICAL SHOCK COULD  
OCCUR AND/OR BRUSH  
COULD SUDDENLY  
RESTART.**

**MAKE SURE** the hose is disconnected and unplugged when not in use.

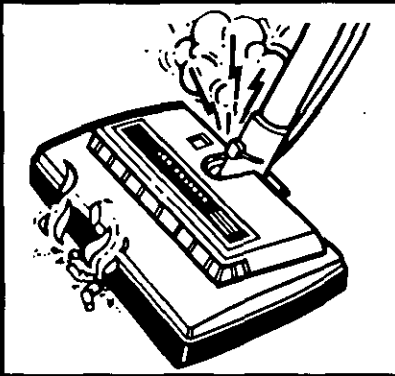

**DO NOT** vacuum cigarette butts, fireplace ashes or flammable vapors from cleaning fluids, perfumes, etc. Fire or explosion could result.

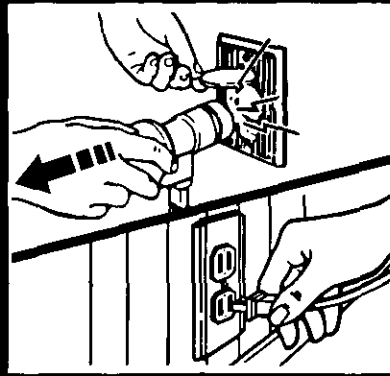

**Always** unplug the hose and hose cord from the wall outlets when not vacuuming. Removing the hose turns off the Power Unit.



**Always** pick up small toys, sharp hard objects, paper, etc. before vacuuming. These objects can damage the cleaner.

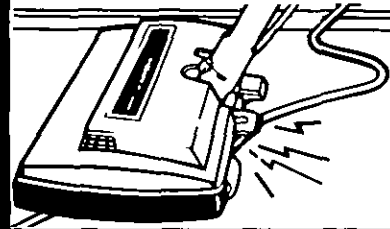

**DO NOT** vacuum over the power cord or place heavy or sharp objects on it. Electrical shock and cord damage could result. Do not operate with a damaged cord or plug.

**NEVER** put hands, feet or hair near the brush or hose end while vacuuming. Personal injury could result.

• FOR YOUR SAFETY •

**DO NOT STORE OR USE GASOLINE OR OTHER FLAMMABLE VAPORS AND LIQUIDS IN THE VICINITY OF THIS OR ANY OTHER APPLIANCE. FIRE AND EXPLOSION COULD RESULT.**

◀ **SAVE THESE INSTRUCTIONS** ▶

# How vacuum cleaning system works

The Power Unit is turned on when the hose is plugged into the wall outlet. Rapidly moving air inside the Power Unit creates suction throughout the system that picks up dirt. The dirt and air are carried through the attachment, hose and built-in wall tubing to the Power Unit. At the Power Unit, dirty air enters the cyclonic separation chamber through the inlet port. As the air circulates, the dirt separates from the air and drops into the dust container. The air then passes through the safety screen and outlet port to the outdoors exhaust port. Outdoors exhausting helps keep your home cleaner.

## **⚠️ WARNING**

### **Electrical Shock And Personal Injury Hazard**

**Disconnect and unplug the vacuuming system before servicing or cleaning it as unit could suddenly start. Failure to do so could result in electrical shock or injury.**

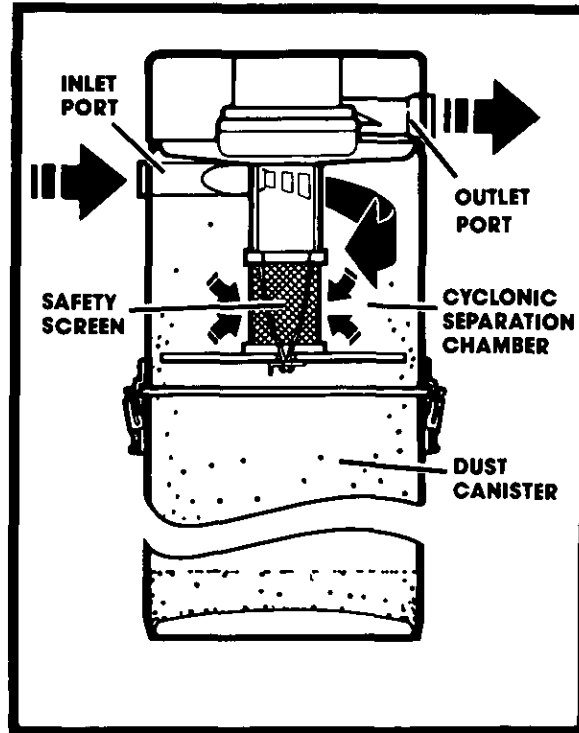



# Parts and Features

It is important to know your vacuum cleaning system parts and features to assure its proper and safe use. Review these before using your vacuum cleaning system.

## Models MC-H1000 and MC-H2000

Copy your model and serial number here . . .

If you need service or call with a question, have this information ready:

1. **Complete** Model and Serial Numbers (from the plates located as shown on each unit).
2. Purchase date from sales slip.

Copy this information in these spaces. Keep this book and your sales slip together in a convenient place.

\_\_\_\_\_

Power Unit Model Number

\_\_\_\_\_

Power Unit Serial Number

\_\_\_\_\_

Power Nozzle Model Number

\_\_\_\_\_

Power Nozzle Serial Number

\_\_\_\_\_

Purchase Date

## OPTIONAL CLEANING ATTACHMENTS to use with your BUILT-IN System

### Power Nozzle for deep-down cleaning (U.L. Class P-F3)

Power out dirt that's deeply embedded in your carpets with our Power Nozzle unit. Its motor-driven beater-bar brush loosens even stubborn dirt so power unit's powerful suction can whisk it away.

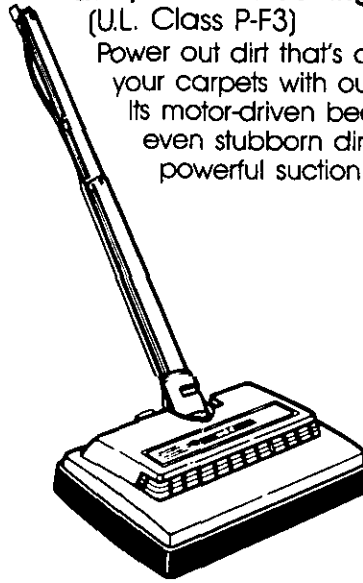

Wall Outlet



Outlets are placed in hallways or near doorways. This allows the 30-ft. hose to reach several rooms from each outlet.

## POWER UNIT

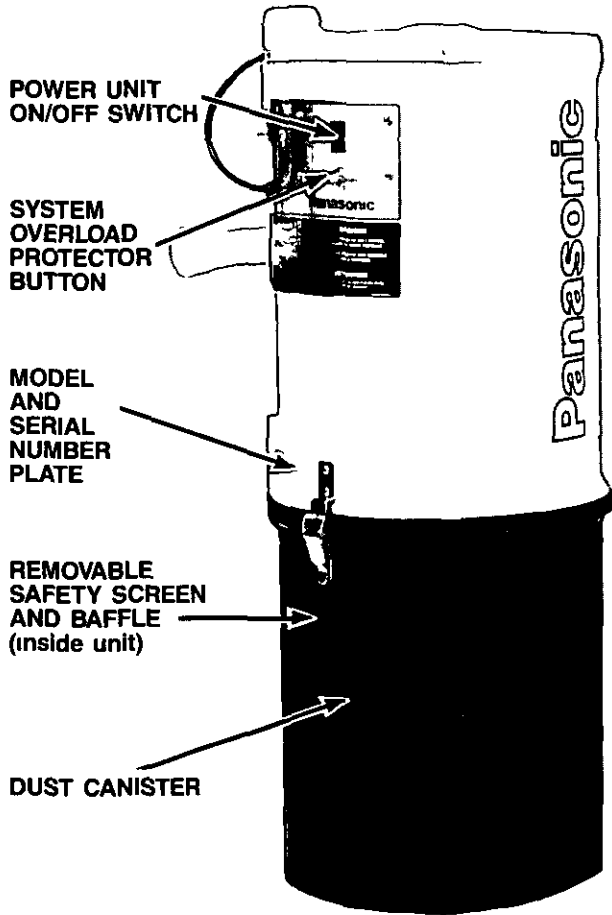

## ATTACHMENT KIT MC-H1100

To use our Power Nozzle unit with built-in system, you must have an Attachment Set MC-H1100 with electrified hose Its dusting brush, crevice tool and floor/wall tool fit on chrome-plated steel wands. Includes tool carrying caddy and hanger bracket for 30-ft electric hose

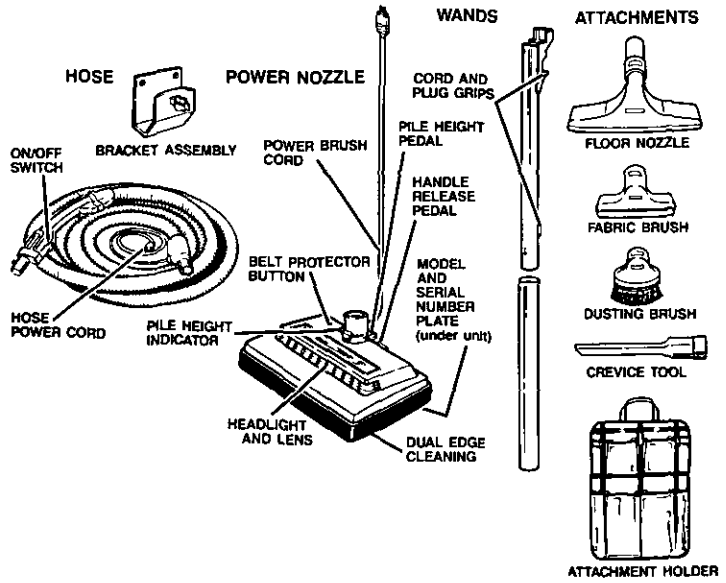

**OPTIONAL OUTLET KITS**  
 MC-H1010 - One valve & fittings  
 MC-H1020 - Two valves & fittings  
 MC-H1030 - Three valves & fittings

## PARTS AND FEATURES

# Assembling your vacuum cleaning system for use

Make sure you have all the parts shown on the "Parts and Features" page. If some parts are missing, call the store where you purchased the system.

## Power Nozzle

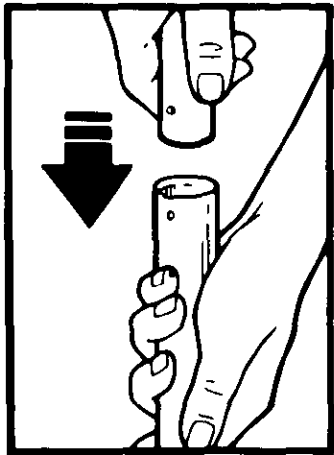

1. Connect and lock the wands together

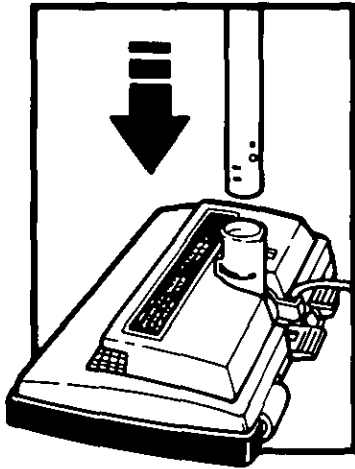

2. Slide the lower wand into the Power Nozzle socket

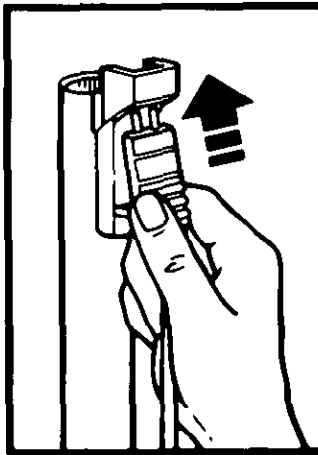

3. Attach the Power Nozzle plug and cord as shown. **Do not force** if hard to insert, turn plug over and try again

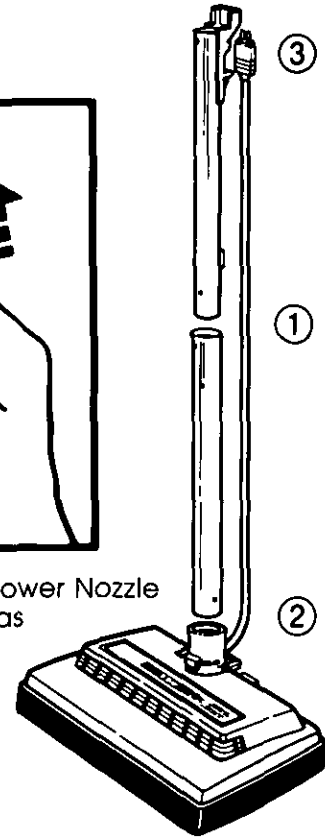

## Hose

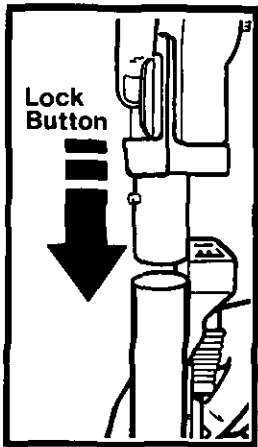

**4.** Slide the handle into the upper wand until the lock button catches

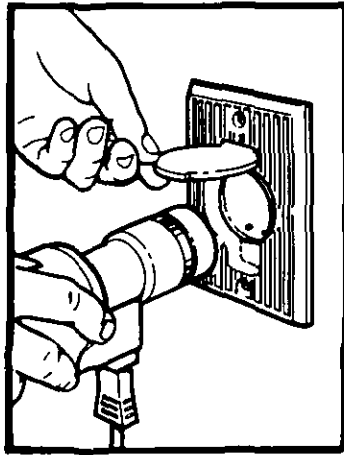

**5.** Lift the wall outlet cover and insert the hose into the outlet. Push firmly to secure. This will turn on the Power Unit.

## Power Unit

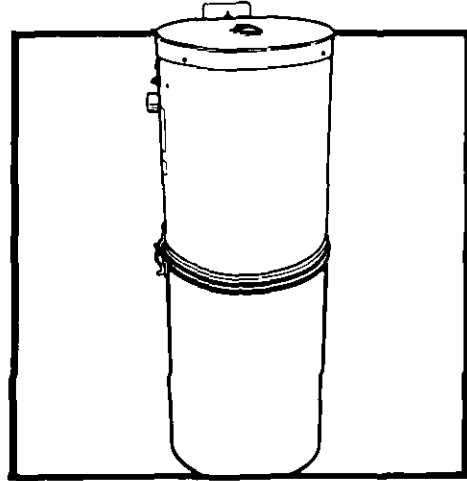

**6.** Before using the first time, make sure the safety screen and dust canister are properly installed. (See pages 19-20.) The Power Nozzle On/Off Switch should be in the "OFF" position.

# Using your vacuum cleaning system

Use your vacuum cleaning system often to keep carpets, floors, furniture, etc. clean. Regular vacuuming helps prevent ground in dirt so carpets stay clean looking longer.

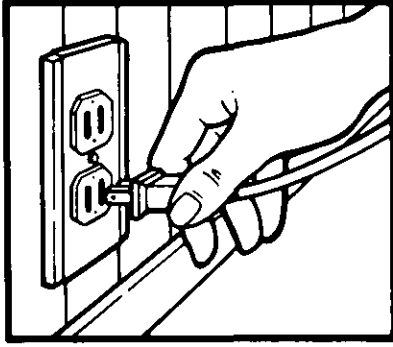

**1.** Handle switch should be OFF. When using the Power Brush, plug hose into a 120 Volt, 60 Hz wall outlet. This provides the power needed to operate the Power Brush.

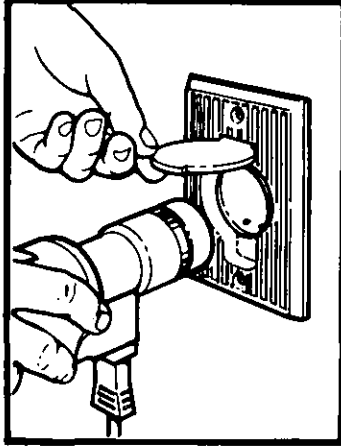

**2.** Lift the wall outlet cover and insert the hose into the outlet. Push in firmly to secure. This will turn on the Power Unit.

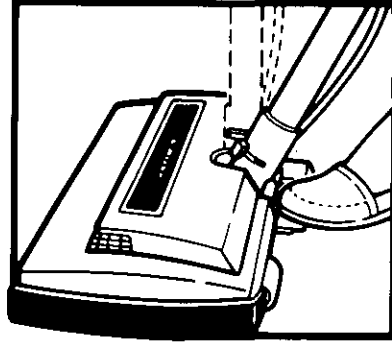

**3.** Press the handle release pedal on the back of the Power Brush to position wands.

## Pile height adjustment

For best results on most carpets, use the **automatic** setting. Use one of the 3 additional settings to make some jobs easier (such as long pile carpets and scatter rugs) and to prevent the vacuum cleaning system from shutting off.

Use the following as a guide:

**AUTO**

Use **AUTO** to vacuum most carpet heights.

**LOW**

Use **LOW** for thick, short to medium pile heights.

**MED**

Use **MED** for most medium to long pile heights.

**HIGH**

Use **HIGH** for thick, long pile heights.

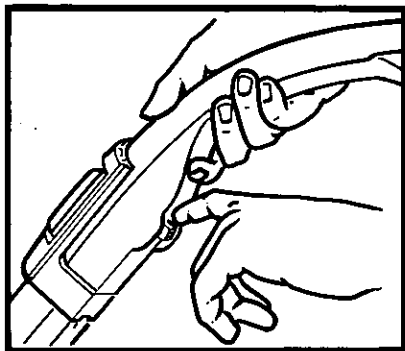

**4.** If Power Nozzle is used, move the "ON-OFF" switch to the ON position. This will automatically turn on the Power Nozzle.

**NOTE:** When cleaning is done, leave hose plugged in for 30 seconds. This will remove dust from the hose and tubing.

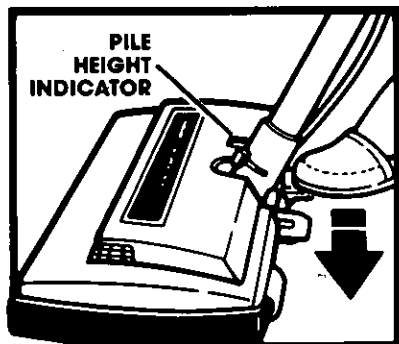

Press the pile height pedal on the back of the Power Nozzle. The setting will show in the window.

# MC-H1100 Attachments

This kit includes two (2) metal extension wands, dusting brush, fabric brush, crevice tool, hose and floor nozzle.

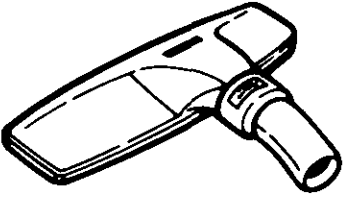

The **Floor Nozzle** is for cleaning hard, smooth surfaces, such as walls and bare floors.

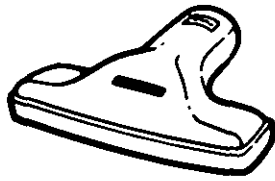

Use the **Fabric brush** on carpeted stairs, upholstered furniture, and draperies, etc.



Use the **Dusting brush** on lamp shades, lighting fixtures, furniture, venetian blinds, books and shelves, etc.

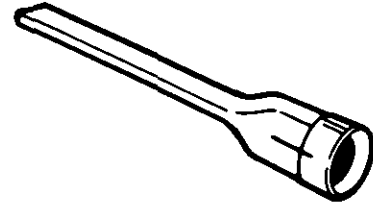

The **Crevice tool** will help clean hard to reach areas, like those between seat cushions, along baseboards and under appliances.

The **Tote Bag** provides a moveable storage place for the attachments and wands when they are not being used. This holder can be hung on a wall and/or carried to a cleaning area.

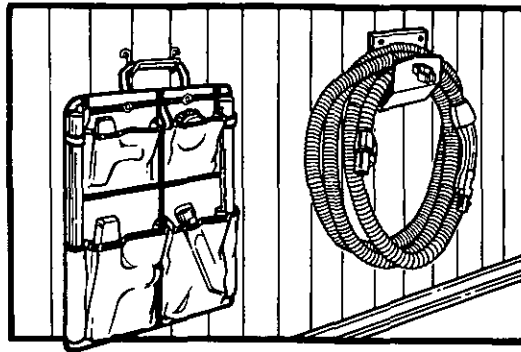

The **Bracket assembly** provides a storage place for the hose when it is not being used. Closets, basements, or garages are convenient installation locations.

To use on end of hose:

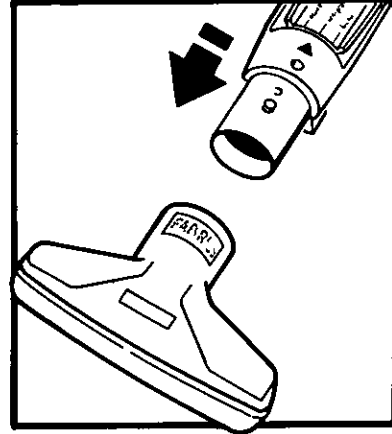
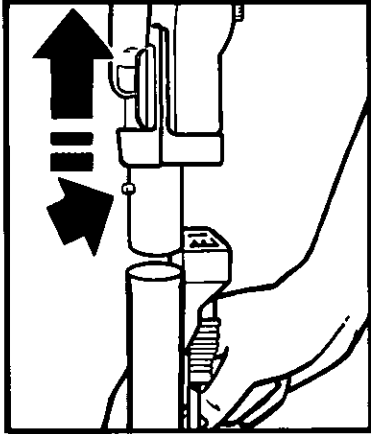

To remove:

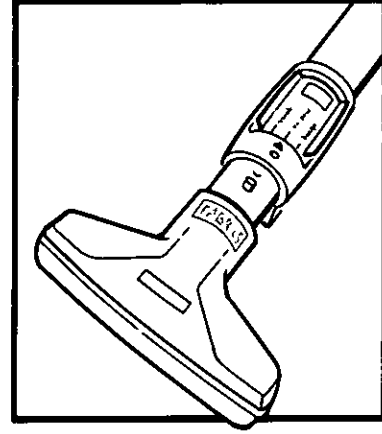

- 2.** Slide on the attachment  
**NOTE:** Some attachments have a hole so the lock button can catch

Press in lock button, if needed, then pull off the attachment

## **! WARNING**

**Electrical Shock Hazard**  
Turn Power Brush to OFF before removing the handle. Failure to do so could result in electrical shock or personal injury.

- 1.** Press in the lock button on the handle and pull the handle out of the wand



To use on wand:

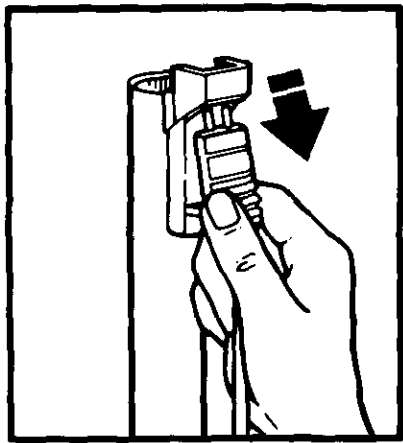

**1. Turn handle control to OFF.** Remove handle from wands. Then pull Power Brush plug out and down.

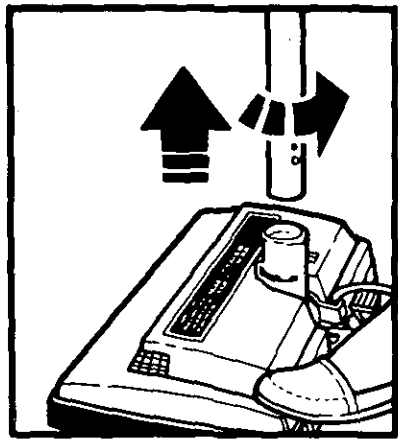

**2. Place foot on Power Brush.** Turn the wands and pull them straight out of the socket.

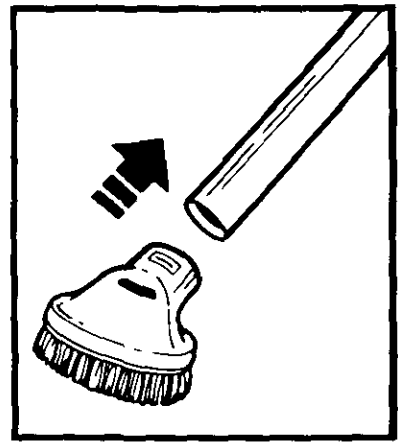

**3. Slide on the attachment.**

## For best results

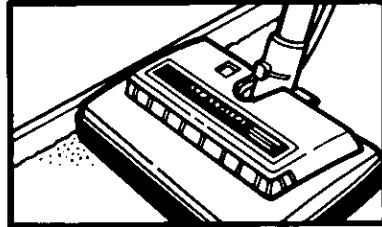

### Carpet edges

Guide either side of the Power Nozzle along a baseboard. The full length brushes help remove trapped dirt at carpet edges.

### Carpeting

Push the Power Nozzle, in an even pattern, over a few sections at a time. Push straight ahead, then pull straight back. At the end of each pull stroke, change the direction of the Power Nozzle to point into the next section. Repeat this pattern, in slow gliding motions. Fast, jerky strokes cause poor cleaning and are more tiring.

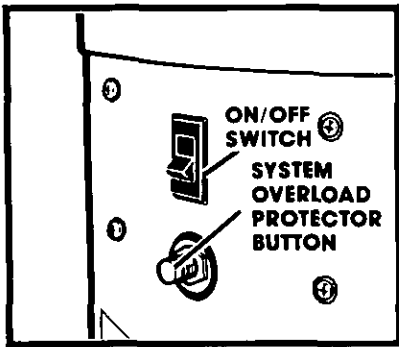

### The System Overload Protector Button

The vacuum cleaning system will shut off if it gets too hot. Unplug the Power Unit and check the system's air path for clogs. Plug in the unit and reset the Overload Protector Button. The ON/OFF Control is used for testing the Power Unit. The Control should be in the OFF position when not being tested.

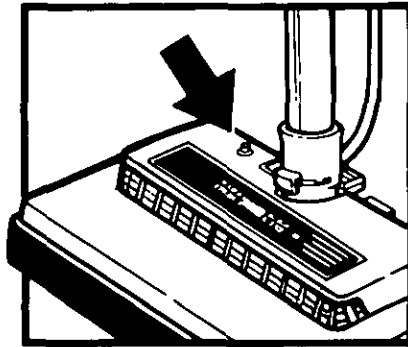

### The Belt Protector Button

The Power Nozzle motor will shut off if the brush is jammed. Turn handle control to OFF, unplug hose and hose cord, and correct the problem. (See Brush Assembly on page 24.) Then push the red reset button so Power Nozzle can be started. Reconnect hose and hose cord. Turn Power Nozzle ON.

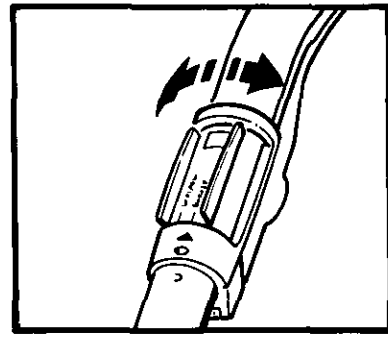

### The Suction Control

Slide the control open to decrease the suction. Open the control for best results on light-weight rugs, draperies, etc... Close the control for maximum suction on carpeting, stairs, upholsteries, etc...

## **! WARNING**

### Electrical Shock And Personal Injury Hazard

Disconnect and unplug the vacuuming system before servicing or cleaning it as unit could suddenly start. Failure to do so could result in electrical shock or injury.

# Caring for your vacuum cleaning system

## **⚠ WARNING**

**Electrical Shock And Personal Injury Hazard**  
Disconnect and unplug the vacuuming system before servicing or cleaning it as unit could suddenly start. Failure to do so could result in electrical shock or injury.

## **Power Unit**

### **Emptying the dust canister**

The dust canister is the lower section of the Power Unit  
Empty canister every two months

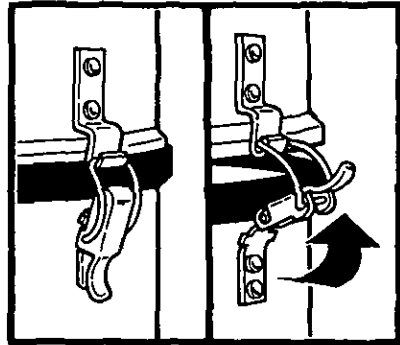

**1. Unplug cord from wall outlet, then release the two side clamps holding the dust canister in place**

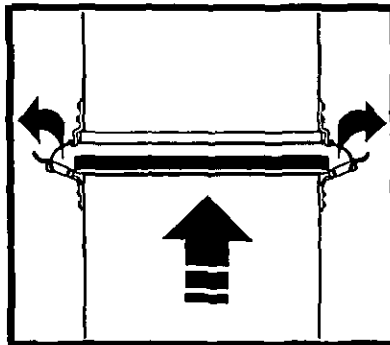

**2. Lift canister slightly to disengage the side clamps**  
Empty the dust canister

### **Cleaning safety screen**

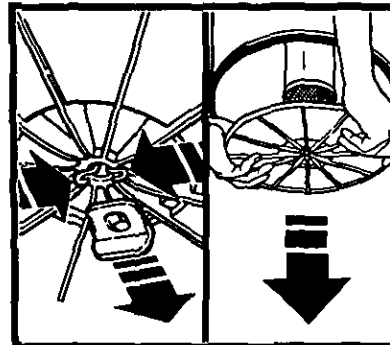

**1. To remove the safety screen and baffle, slide out retainer and squeeze wires (as shown) Pull down on baffle to remove the assembly**

## To replace

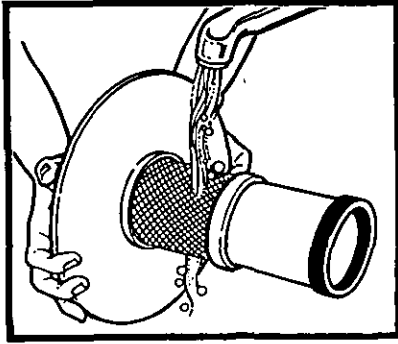

**2.** Tap baffle and safety screen on dust canister to loosen dust, then rinse with water. Dry baffle and screen completely before replacing them.

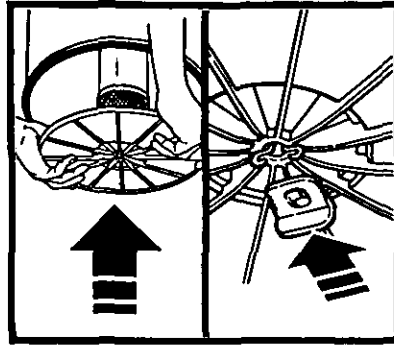

**1.** Slide safety screen and baffle assembly over the wires until the ends snap through the bottom center holes. Replace the retainer.

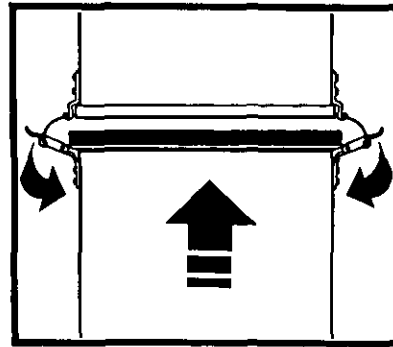

**2.** Replace the dust canister. Attach the two side clamps, then press both latches down at the same time to lock the canister into place. **NOTE: The seal between the Power Unit halves must seat evenly for proper operation.**

# Care Chart

<b>PART</b>	<b>WHAT TO USE</b>	<b>HOW TO CLEAN</b>
<b>Power Nozzle Exterior</b>	Soft cloth and liquid fabric softener	<ul style="list-style-type: none"><li>• <b>Unplug hose and hose cord from wall outlets.</b></li><li>• Wipe with liquid fabric softener on a soft cloth</li><li>• <b>Fabric softener reduces static electricity and dust build-up.</b></li><li>• <b>Do not use abrasive or harsh cleansers.</b></li></ul>
<b>Dust Canister</b>		<ul style="list-style-type: none"><li>• <b>Unplug Power Unit</b></li><li>• Remove dust canister, empty contents, then replace (See pages 19 and 20 )</li></ul>
<b>Safety Screen</b>	Warm water and mild detergent	<ul style="list-style-type: none"><li>• <b>Unplug Power Unit.</b></li><li>• Check safety screen every time dust canister is emptied</li><li>• Remove safety screen and baffle assembly (See page 19 )</li><li>• Gently tap assembly over dust canister, then wash in warm soapy water. Rinse well and dry completely</li><li>• <b>Do not clean in dishwasher</b></li><li>• <b>Do not operate with a wet safety screen or without a safety screen</b></li><li>• Replace the safety screen assembly (See page 20 )</li></ul>
<b>Power Nozzle Brushes</b>		<ul style="list-style-type: none"><li>• <b>Unplug hose and hose cord from wall outlets.</b></li><li>• Turn Power Nozzle over to remove hair and string from around brush assembly</li></ul>
<b>Brush Supports (See page 23)</b>	Screwdriver and a dust cloth	<ul style="list-style-type: none"><li>• <b>Unplug hose and hose cord from wall outlets.</b></li><li>• Remove the Power Nozzle covers. A screwdriver will be needed. See "Changing the belt" (See page 22 )</li><li>• Remove brush assembly from base and disassemble. See "Changing the belt" (See page 22 )</li><li>• <b>DO NOT LOSE THE WASHERS ON THE BRUSH ENDS</b></li><li>• Wipe brush supports with a clean cloth to remove hair, string and lint build-up</li><li>• Replace brush assembly in base, then re-assemble the Power Nozzle. See "Changing the belt" (See page 22 )</li></ul>

<b>PART</b>	<b>WHAT TO USE</b>	<b>HOW TO CLEAN</b>
<b>Hose or Wands</b>	Broom handle	<ul style="list-style-type: none"> <li>• <b>Unplug hose and hose cord from wall outlets.</b></li> <li>• Insert broom handle into wand or hose ends to break up and clear clogs.</li> <li>• <b>BE CAREFUL NOT TO PUNCTURE HOSE.</b></li> </ul>
<b>Attachments</b>	Warm water and mild detergent	<ul style="list-style-type: none"> <li>• <b>Remove from vacuum cleaning system.</b></li> <li>• Wash attachments in warm soapy water, rinse, then air dry.</li> <li>• <b>Do not place attachments in dishwasher.</b></li> <li>• <b>Do not use attachments if wet.</b></li> </ul> <p><b>NOTE: wash attachments that have been used in dirty areas, (such as under a refrigerator), before using them on furniture, draperies, walls, etc. Dirty attachments could leave marks.</b></p>

## **WARNING**

### **Power Nozzle**

**WARNING** – To avoid possible electrical shock or other injury, always unplug the Power Nozzle from the hose before servicing or cleaning the Power Nozzle.

## **Changing the belt**

If the brush stops rotating, the belt may be worn or broken. Check or replace the belt as follows:

**Disconnect hose and hose cord from electrical outlets and remove wands.**

To remove:

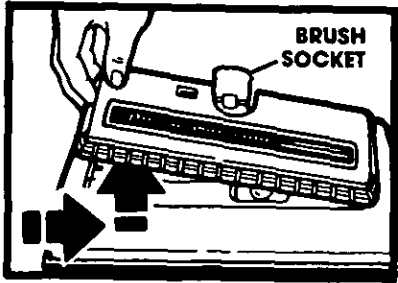

1. Position the Power Nozzle socket in the down position. Remove the light cover. Press in and lift one side, then the other. Be careful to clear the reset button.

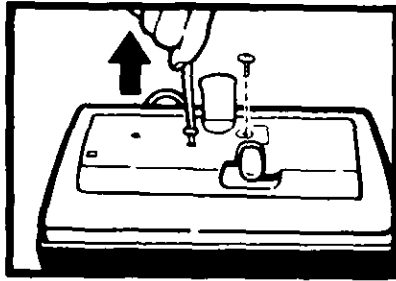

2. Take out 2 screws, to remove the Power Nozzle cover.

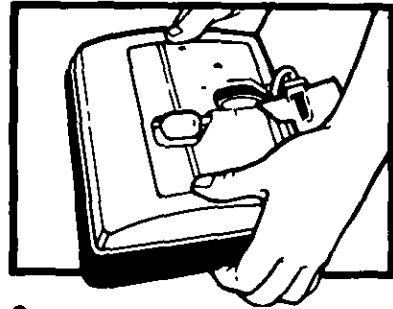

3. Grasp both sides of the cover and flex outward to release the side tabs.

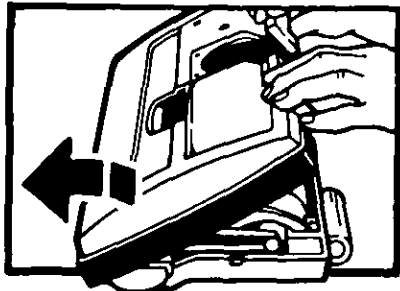

4. Tilt the cover forward until the front tabs snap free.

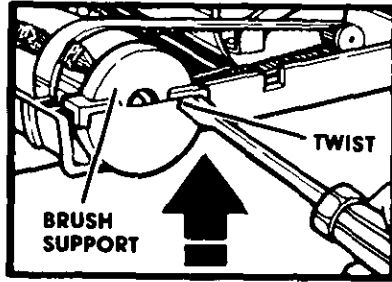

5. Carefully insert and twist a screwdriver between each brush support and the base to free the brush assembly.

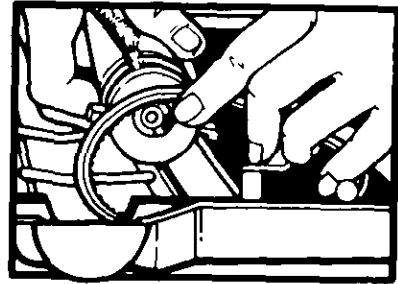

6. Lift the brush assembly to slide off the old belt.



**To replace:**

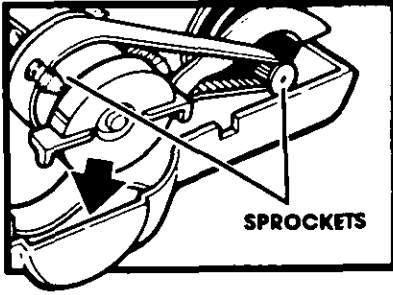

**1.** Place the new belt on the brush and motor drive sprockets. Lower the brush assembly into the base. Snap brush supports into place.

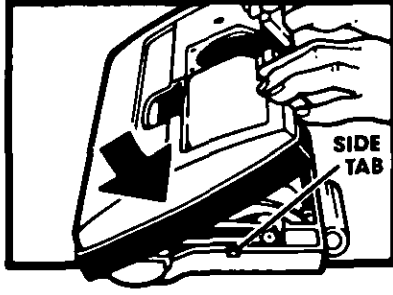

**2.** Line up the front tabs to replace the cover. Be sure the red Belt Protector Button is aligned with the cover opening. Press down on both sides of the cover to lock the side tabs.

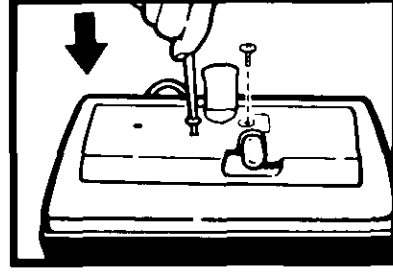

**3.** Replace the cover screws. **NOTE: Do not overtighten. Overtightening could strip the screw holes.** Snap on the light cover.

**Brush Assembly**

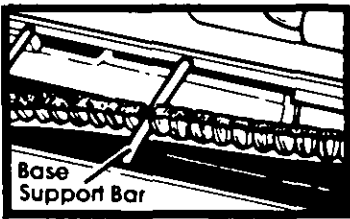

Replace the brushes and beater bar if worn or broken. The brushes should extend past the base supports. The beater bar should be smooth with no chips, gouges, or breaks.

**⚠ WARNING**

**Electrical Shock And Personal Injury Hazard**  
**Disconnect and unplug the Power Brush before servicing or cleaning it as unit could suddenly start. Failure to do so could result in electrical shock or injury.**

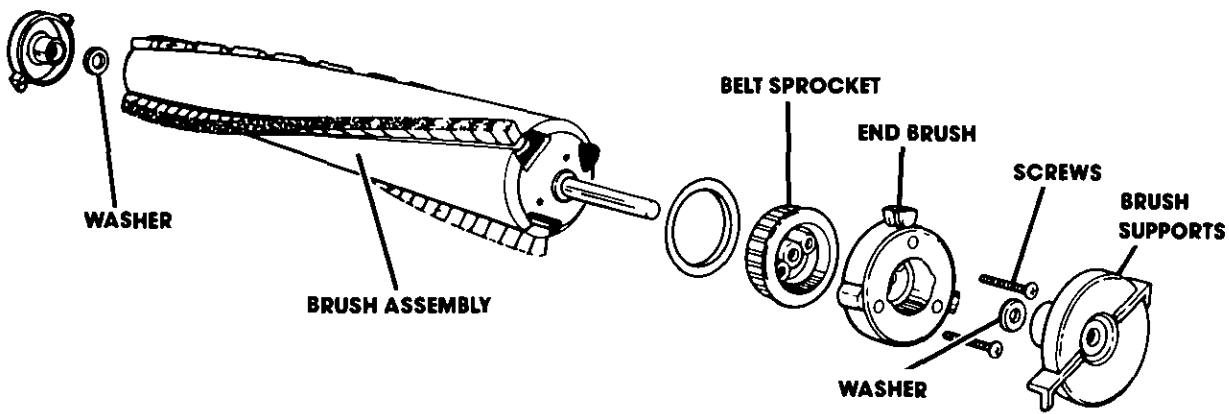

1. Remove the light cover, the Power Nozzle cover and brush assembly by following the steps on pages 22 and 23

2. Pull off the brush supports and washers **DO NOT LOSE THE WASHERS.**

3. Remove the screws, and brush end sprocket

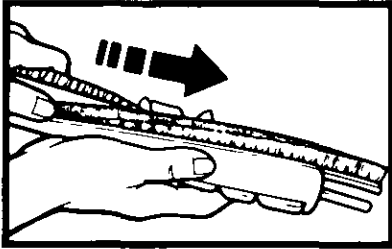

4. Push out the old brushes and beater bar

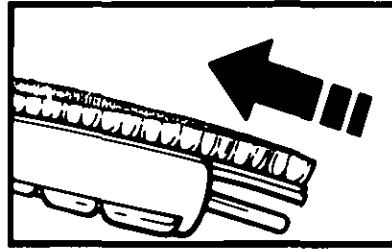

5. Slide the new brushes and beater bar into the slots **NOTE: To make brushes and beater bar easier to install, soak them in warm water for a few minutes, dry completely then slide into the slots**

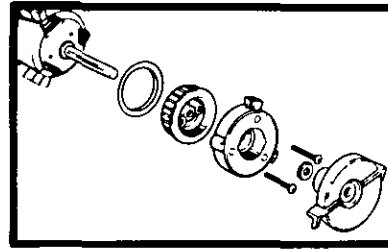

6. Replace the sprocket, so the sprocket tab is aligned with the slot at the beater bar Replace the end brush, screws, washers and brush supports Install the belt and replace the brush assembly and top covers See page 22 for detailed instructions

## Headlight

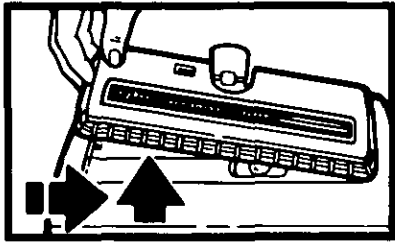

1. Press in and lift one side of the light cover, then the other.

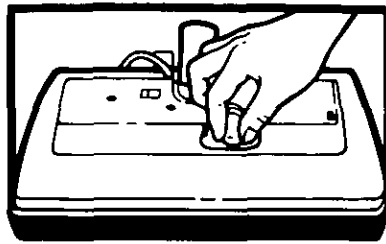

2. Push in and turn the headlight to remove.

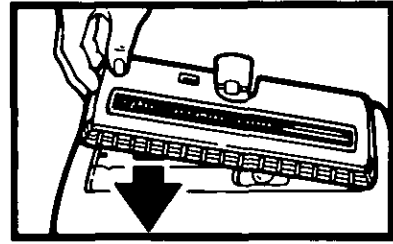

3. Replace the 15-watt bayonet base-type light bulb, then replace the light cover and lens.

**CAUTION:** Do not use a bulb rated over 15 watts. During extended use, heat from the bulb could overheat surrounding plastic parts.

## If you need service or assistance, we suggest you follow these steps:

### Before calling for assistance...

Performance problems often result from little things you can find and fix yourself without tools of any kind.

#### If nothing operates:

- Is the Power Unit power cord plugged into a 120 volt outlet?
- Have you checked your home's fuses or circuit breaker box?

#### If the vacuum cleaning system does a poor job of dirt pick-up:

- Are all the unused hose outlet covers completely closed?
- Is there a suction leak in the system? Turn system on and listen for hissing or whistling.
- Is the dust canister full or the air path clogged?
- Is the safety screen dirty?

#### If the Power Nozzle picks up rug edges or pushes too hard:

- Is the pile height adjustment setting too low? (See page 13.)
- Is the suction control completely closed?

**If the vacuum cleaning system will not run:**

- Are the hose and electrical connections properly attached? (See page 10 & 11.)
- Have you tried a different hose wall valve? The wiring connection to the wall valve may be loose.
- Did you check the Power Unit Overload Protector? Reset if needed. (See page 18.)

**If the vacuum cleaning system starts, then shuts off:**

- Are the hose connections or hose cord connection unplugged?
- Did you check the Power Unit Overload Protector? Reset if needed. (See page 18.)

- Is the pile height adjustment too high? (See page 13.)
- Is the suction control open?
- Is there a hole in the hose?
- Are the Power Nozzle brushes and/or beater bar worn or broken? (See page 25.)
- Is the Power Nozzle belt broken or out of place?

**If the system overload protector button pops:**

- Does the dirt canister need to be emptied?
- Is the safety screen dirty?
- Is there a clog in the air path? (See page 18.)

**If the Power Nozzle light will not work:**

- Are the hose connections completely plugged in?
- Is the bulb burned out?

**If the vacuum cleaning system leaves marks on the carpet, you may be using the wrong vacuuming pattern. (See page 17.)**

**After checking the above service hints, please refer to the back cover for further assistance.**

## What To Do When Service Is Needed

If your Panasonic Vacuum Cleaner needs service, look in the yellow pages of the telephone book under "Home Appliance Service" for your nearest Matsushita Service Company ("MSC") Factory Servicenter, or MSC authorized Servicenter, or call 1-800-545-2672, toll free to find a convenient servicenter. Do NOT send the product to the Executive or Regional Sales offices. They are NOT equipped to make repairs.

Consumers requiring product information or operating assistance with a consumer product should contact:

**CONSUMER AFFAIRS DEPARTMENT 2F-3**

50 Meadowlands Parkway  
Secaucus, N.J. 07094  
(201) 348-9090

**DIAL TOLL FREE**

1-800-545-2672

Matsushita Services Co.

24 hours a day, 7 days a week

Service in Puerto Rico

**MATSUSHITA ELECTRIC OF PUERTO RICO, INC.**

Panasonic Sales Company/Factory Servicenter  
San Gabriel Industrial Park  
65th Infantry Avenue KM 9.5  
Carolina, Puerto Rico 00630 (809) 750-5135

**PANASONIC COMPANY,  
DIVISION OF MATSUSHITA  
ELECTRIC CORPORATION  
OF AMERICA**

1 Panasonic Way  
Secaucus, New Jersey 07094

**PANASONIC COMPANY (WEST) OF AMERICA  
DIVISION OF MATSUSHITA  
ELECTRIC CORPORATION  
OF AMERICA**

6550 Katella Ave.  
Cypress, CA 90630

**PANASONIC SALES COMPANY,  
DIVISION OF MATSUSHITA  
ELECTRIC OF  
PUERTO RICO, INC.**

San Gabriel Industrial Park  
65th Infantry Ave., KM. 9.5  
Carolina, Puerto Rico 00630

C01ZZ00U