

This Owner's Manual is provided and hosted by [Appliance Factory Parts](#).



PANASONIC MC-V3110 Owner's Manual

[Shop genuine replacement parts for PANASONIC
MC-V3110](#)



[Find Your PANASONIC Vacuum Cleaner Parts - Select From 605 Models](#)

----- Manual continues below -----

Panasonic®

COMMERCIAL VACUUM CLEANER

Aspirateur commercial

Commercial aspiradora

MC-V3110

Operating Instructions

Manuel d'utilisation

Instrucciones de operación

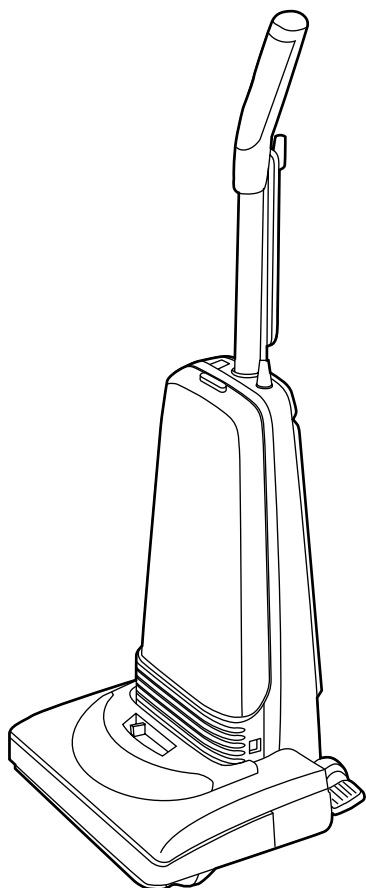

Before operating your vacuum cleaner, please read these instructions completely.

Avant d'utiliser l'appareil, il est recommandé de lire attentivement ce manuel.

Antes de usar su aspiradora, lea completamente estas instrucciones por favor.

C01ZCDH000000

CONSUMER INFORMATION

Please read **IMPORTANT SAFETY INSTRUCTIONS** on page 5 before use. Read and understand all instructions.

TO OUR VALUED CUSTOMER

We are very pleased to welcome you to the Panasonic family of products. Thank you for purchasing this product. Our intent is that you become one of our many satisfied customers.

Proper assembly and safe use of your vacuum cleaner are your responsibilities. Your vacuum cleaner is intended only for commercial use. The cleaner should be stored in a dry, indoor area. Read the Operating Instructions carefully for important use and safety information.

Special care is required when vacuuming certain types of carpet or floor covering. Always check the carpet or floor covering manufacturer's recommended cleaning instructions before vacuuming.

PLEASE PAY CLOSE ATTENTION TO ALL WARNING AND CAUTION STATEMENTS.



WARNING statements are designed to alert you to the possibility of personal injury, loss of human life, and/or damage to the vacuum cleaner and/or personal property if the instructions given are not followed.



CAUTION statements are designed to alert you to the possibility of damage to the vacuum cleaner and/or personal property if the instructions given are not followed.



TO AVOID ELECTRICAL SHOCK

Never vacuum damp or wet surfaces or liquids.
DO NOT store machine outdoors.
Replace worn or frayed power cord immediately.
Unplug from outlet when not in use and before servicing.

TO AVOID ACCIDENTS

Except for hand-held cleaners, keep machine on floor - not chairs, tables, steps, stairs, etc.
Store machine promptly after each use to prevent accidents such as tripping over power cord or machine.
Use machine and accessories only in a manner intended by the manufacturer.
The use of an extension cord is not recommended.

IMPORTANT SAFETY INSTRUCTIONS

When using vacuum cleaner, basic precautions should always be followed, including the following:

READ ALL INSTRUCTIONS BEFORE USING THIS VACUUM CLEANER



WARNING

To reduce the risk of fire, electrical shock, injury:

1. **DO NOT** leave vacuum cleaner when plugged in. Unplug from outlet when not in use and before servicing.
2. To reduce the risk of fire or electric shock - **DO NOT** use outdoors or on wet surfaces.
3. **DO NOT** allow to be used as a toy. Close attention is necessary when used by or near children.
4. Use only as described in this manual. Use only manufacturer's recommended tools.
5. **DO NOT** use with damaged cord or plug. If vacuum cleaner is not working as it should, has been dropped, damaged, left outdoors, or dropped into water, return it to an authorized Panasonic Servicenter.
6. **DO NOT** pull or carry by cord, use cord as a handle, close door on cord, or pull cord around sharp edges or corners. **DO NOT** run vacuum cleaner over cord. Keep cord away from heated surfaces.
7. **DO NOT** unplug by pulling on cord. To unplug, grasp the plug, not the cord.
8. **DO NOT** handle plug or vacuum cleaner with wet hands.
9. **DO NOT** put any objects into openings. **DO NOT** use with any opening blocked; keep free of dust, lint, hair, and anything that may reduce air flow.
10. Keep hair, loose clothing, fingers, and all parts of body away from openings and moving parts.
11. **DO NOT** pick up anything that is burning or smoking, such as cigarettes, matches, or hot ashes.
12. **DO NOT** use without dust bag and/or filters in place.
13. Turn off all controls before unplugging.
14. Use extra care when cleaning on stairs.
15. **DO NOT** use cleaner to pick up flammable or combustible liquids such as gasoline or use in areas where they may be present.
16. **DO NOT** operate cleaner without belt cover properly installed.

SAVE THESE INSTRUCTIONS

Note: Before you plug in your Panasonic vacuum cleaner, make sure that the voltage indicated on the rating plate located at the back of the vacuum cleaner is the same as your local supply.

TABLE OF CONTENTS

CONSUMER INFORMATION	2
IMPORTANT SAFETY INSTRUCTIONS	5
GROUNDING INSTRUCTIONS	10
PARTS IDENTIFICATION	12
FEATURE CHART	13
ASSEMBLY	14
Attaching Handle	14
Tool Storage	16
FEATURES	18
Carpet Height Selector	18
Edge Cleaning	18
Motor Protector	18
TO OPERATE CLEANER	20
ON-OFF Switch	20
Handle Adjustments	20
Using Tools	22
ROUTINE CARE OF CLEANER	24
Cleaning Secondary Foam Filter	24
Replacing HEPA Exhaust Filter	26
Changing Dust Bag	28
Removing and Installing Lower Plate	30
Replacing Belt	32
Cleaning Agitator	34
Replacing Agitator	34
Agitator Assembly	36
Cleaning Exterior and Tools	36
Removing Clogs	38
BEFORE REQUESTING SERVICE	40
WARRANTY	43
WHAT TO DO WHEN SERVICE IS NEEDED	back cover

GROUNDING INSTRUCTIONS

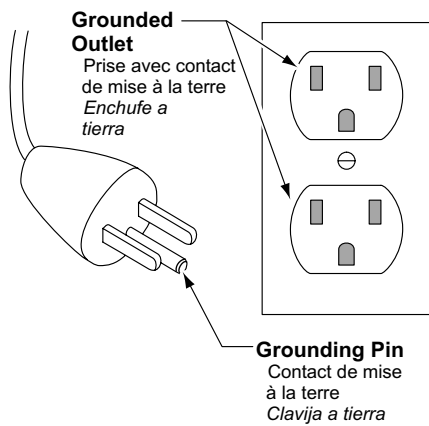

(Fig. A)

This vacuum cleaner must be grounded. If it should malfunction or breakdown, grounding provides a path of least resistance for electric current to reduce the risk of electric shock. This vacuum cleaner is equipped with a cord having an equipment-grounding conductor and grounding plug. The plug must be plugged into an appropriate outlet that is properly installed and grounded in accordance with all local codes and ordinances.



DANGER

- Improper connection of the equipment-grounding conductor can result in a risk of electric shock. Check with a qualified electrician or service person if you are in doubt as to whether the outlet is properly grounded.
- Do not modify the plug provided with the vacuum cleaner – if it will not fit the outlet, have a proper outlet installed by a qualified electrician.
- This vacuum cleaner is for use on a nominal 120-volt circuit, and has a grounding plug that looks like the plug illustrated in (Figure A). Make sure that this vacuum cleaner is connected to an outlet having the same configuration as the plug.
- No adapter should be used with this vacuum cleaner.

Note: Before you plug in your Panasonic vacuum cleaner, make sure that the voltage indicated on the rating plate located at the back of the vacuum cleaner is the same as your local supply.

PARTS IDENTIFICATION

Identificación de piezas Nomenclature

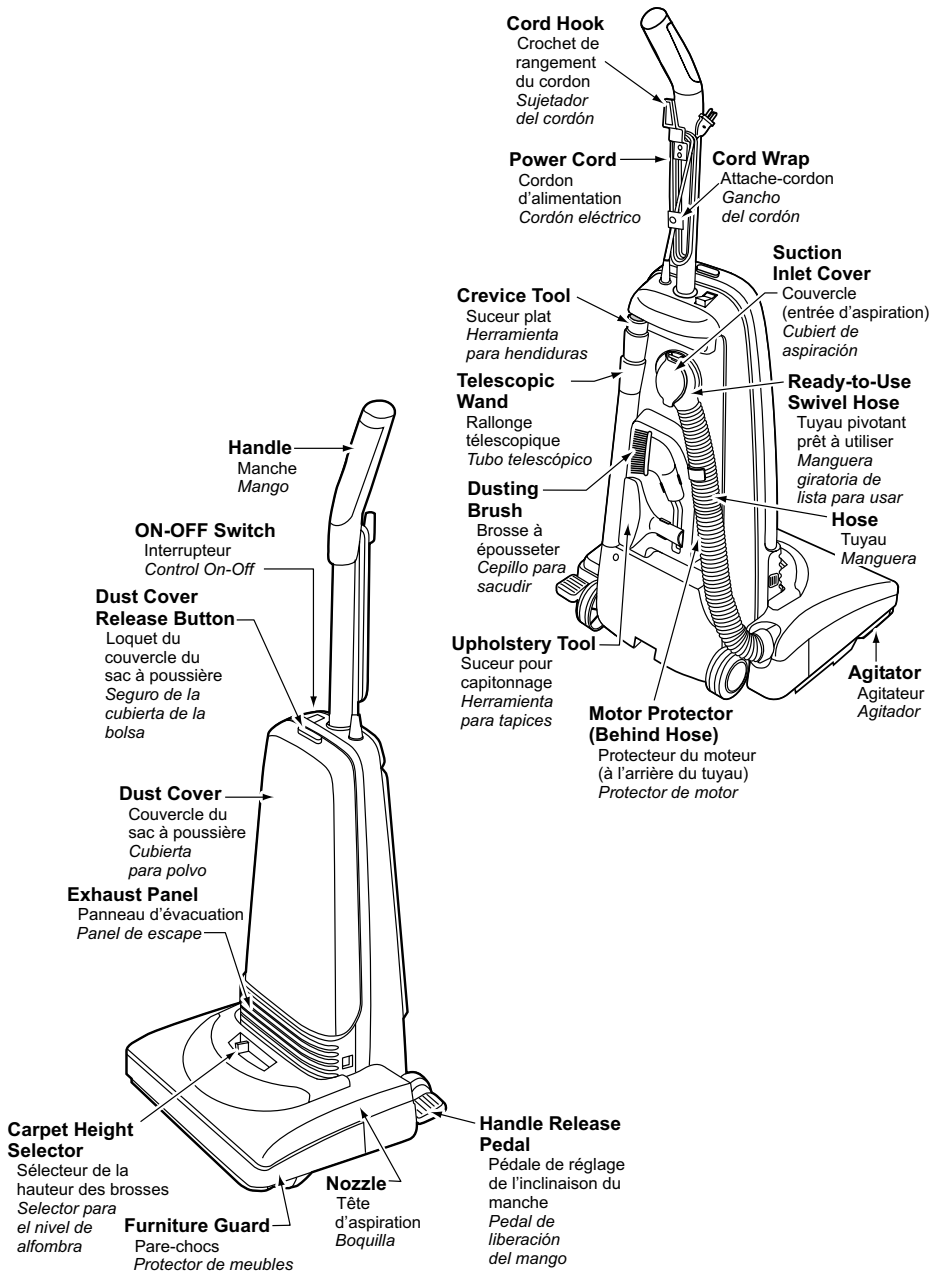

FEATURE CHART

Power	Motor Protector	Height Adjust	Cord Length
120V AC(60Hz)	Yes	4 positions	50 Ft. (15.25m)

Tableau des caractéristiques

Alimentation	Protecteur du moteur	Réglage de la hauteur des brosses	Cordon d'alimentation
120 V c.a. (60 Hz)	Oui	4 positions	15,25 m (50 pi)

Diagrama de características

<i>Voltaje</i>	<i>Protector de motor</i>	<i>Adjust de nivel</i>	<i>Extensión de cordón</i>
120V AC(60Hz)	Si	4 posiciones	15,25 m (50 pi)

ASSEMBLY

Attaching Handle

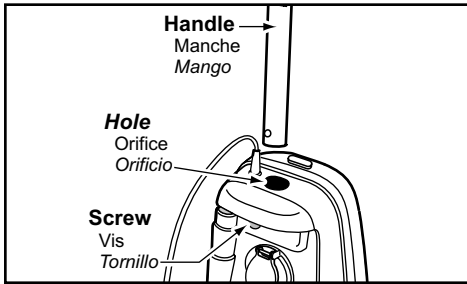

1)

- DO NOT plug in until assembly is complete.
- Remove handle screw.
- Insert handle with cord hook to the back of the cleaner.

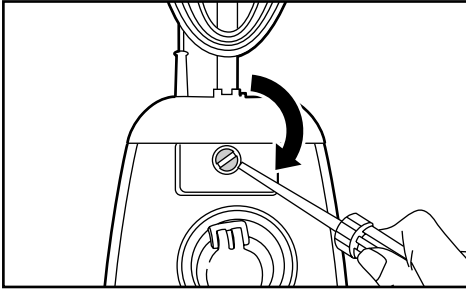

2)

- Insert screw.
- Tighten screw.

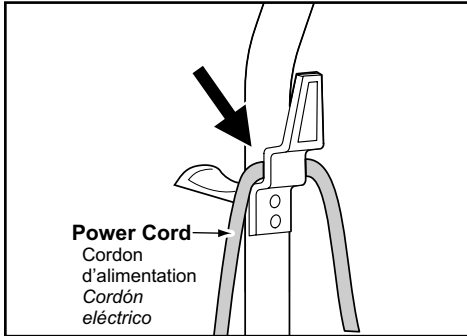

3)

- Push power cord into cord clip.

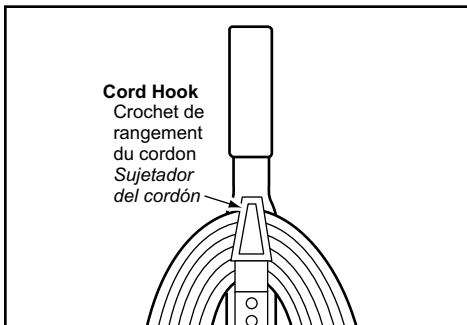

4)

- Wrap power cord around cord hook.
- Secure retainer (plug head) to power cord.

Tool Storage

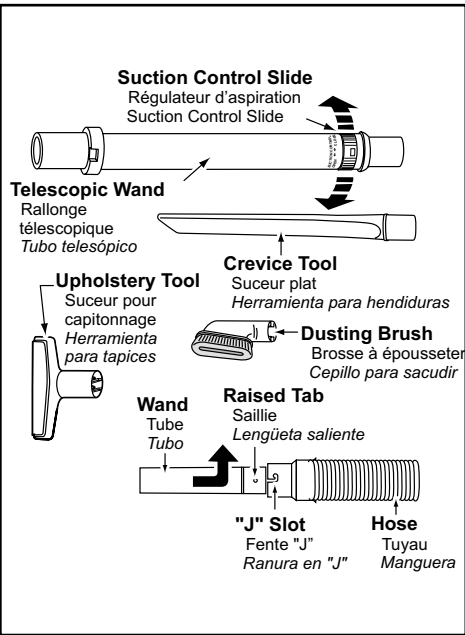

- Some tools may already be stored on vacuum cleaner.
- Insert crevice tool, cleaning end first, into end of telescopic wand opposite the suction control.
- Place telescopic wand on back of cleaner with crevice tool on top.
- Store dusting brush and upholstery tool in rear of dust compartment.
- Insert hose into opening at back of nozzle.
- To use telescopic wand for cleaning, attach it to hose by aligning the two (2) raised tabs on wand with "J" slots in hose, guide tabs along grooves, twist to lock in place.



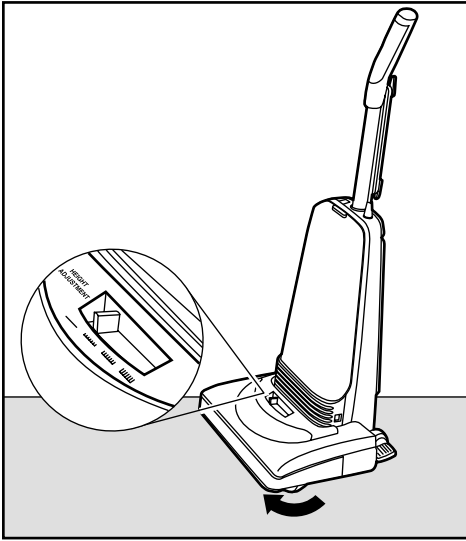

FEATURES

Carpet Height Selector



- Allows for adjustments to efficiently and safely clean different types of floors.
- To select pile height setting, first turn off vacuum.
- Tilt vacuum back and slide adjustment lever to desired setting.

SUGGESTED CARPET HEIGHT SETTINGS:

-  Shag carpet, long pile, plush, scatter rugs.
-  Medium to long pile.
-  Short to medium pile.
-  Very low pile.

Edge Cleaning

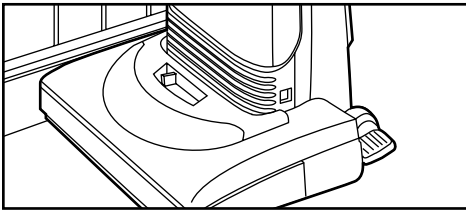

- Edge cleaning feature enables improved cleaning of carpets near walls and furniture.

Motor Protector

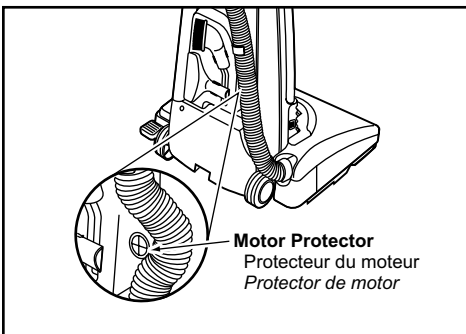

- Automatically opens to provide cooling air to the motor when a clog occurs or when dust bag needs changing.
- Motor protector may open when using tools.
- If motor protector opens, the vacuum will make a slightly different sound.

Note: Do not block motor protector.

TO OPERATE CLEANER

ON-OFF Switch

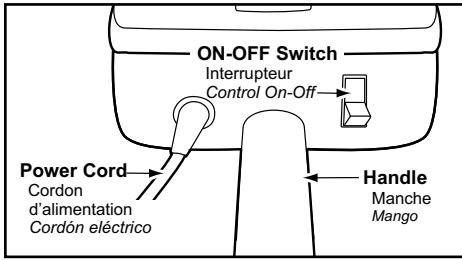

- Ensure ON-OFF switch is OFF.
- Plug the power cord into 120V outlet.
- ON position turns vacuum on.
- OFF position turns vacuum off.

Handle Adjustments

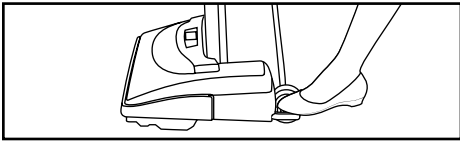

1)

- Step on handle release pedal to change handle position.

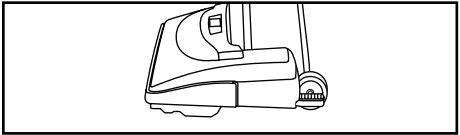

2)

- Move vacuum to upright position for storage and tool use.

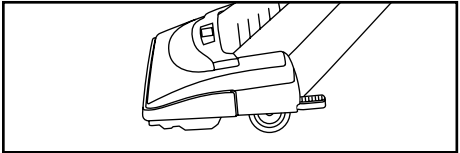

3)

- Move vacuum to middle position for normal use.

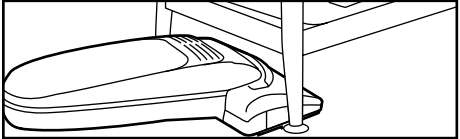

4)

- Use low position for cleaning under furniture.

Using Tools

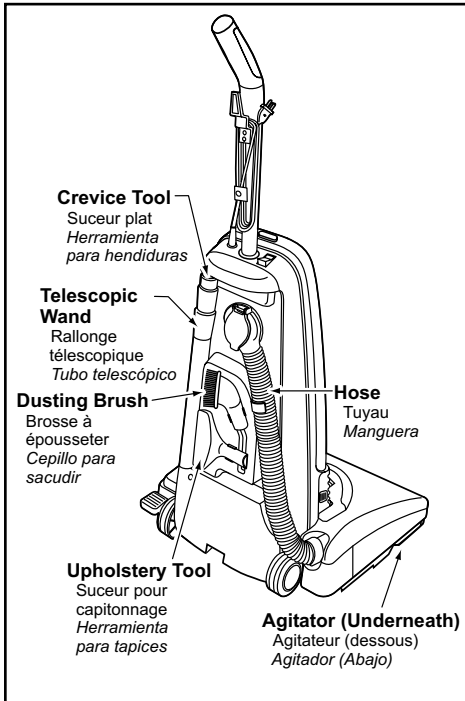

CAUTION

If tools are used, and vacuum is left in upright position, carpet damage could occur.

Agitator rotates when using tools, use care to ensure that nothing comes into contact with agitator.

- Remove lower end of stretch hose from the back of the nozzle by twisting and pulling straight out.
- The tools can be attached to hose, wand or crevice tool.
- Remove telescopic wand from vacuum.
- Remove crevice tool from telescopic wand.
- To extend wand, turn locking ring to **UNLOCK** position and pull out to full length.
- Turn locking ring to **LOCK** position.
- **DO NOT** overextend your reach with hose as it could tip vacuum.
- Place all tools and hose back in the same manner as shown in **TOOL STORAGE**.

Tool Usage

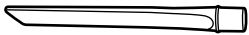

- The Crevice Tool may be used on the following items:
 - Furniture
 - Cushions
 - Drapes
 - Stairs
 - Walls

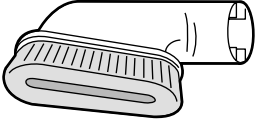

- The Dusting Brush may be used on the following items:
 - Furniture
 - Drapes
 - Stairs
 - Walls

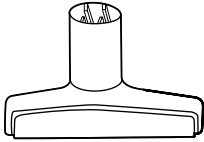

- The Upholstery Tool may be used on the following items:
 - Furniture
 - Cushions
 - Drapes

ROUTINE CARE OF CLEANER

Performing the following tasks will keep your new Panasonic vacuum cleaner operating at peak performance levels and will ensure these high levels for years to come. Check the **BEFORE REQUESTING SERVICE** section in this manual for recommendations on performing some of these tasks to help solve various problems that may occur.

Cleaning Secondary Foam Filter

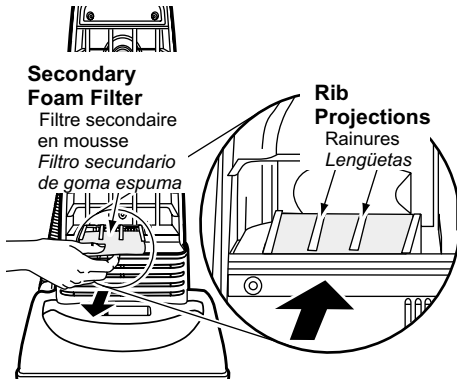

- Secondary foam filter protects the motor.
- Check filter when installing a new dust bag.
- If dirty, pull filter from bottom of dust compartment and clean by rinsing in water.
- When dry, slide filter back into place.
- Ensure filter is fully inserted under plastic rib projections.

Replacing HEPA Exhaust Filter

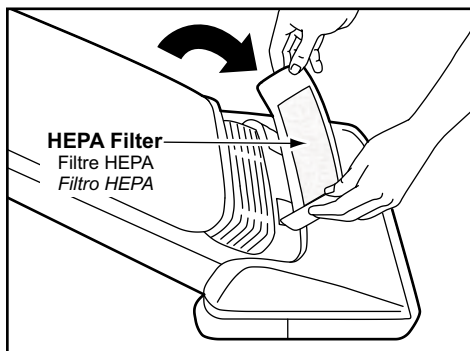

- The HEPA exhaust filter removes dirt from recirculated air.
- Check filter when installing a new dust bag.
- To check filter, place handle in low position.
- Press inward on both sides of exhaust panel and remove by pulling forward.
- Remove filter if dirty.
- Place new filter (Panasonic MC-V197H only) in exhaust panel. **DO NOT CLEAN WITH WATER***
- Position new filter so slits in filter fit around the four (4) raised pins.

* Filter cannot be cleaned and should be replaced at least once each year.

Changing Dust Bag

Always operate vacuum with genuine Panasonic Type U3 Standard or U6 Electrostatic dust bags installed. Panasonic dust bags may be purchased through any authorized Panasonic dealer or ordered from service company.

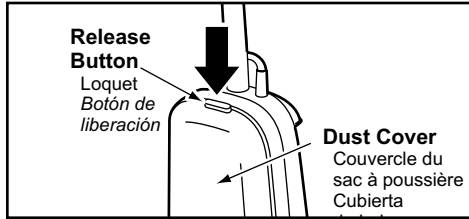

1)

- Press release button and pull outward to remove dust cover.

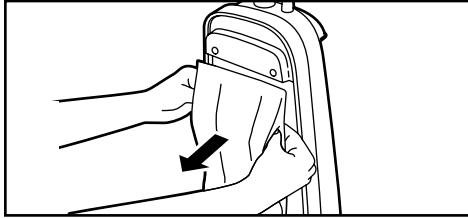

2)

- Remove dust bag by grasping cardboard portion and pulling out.

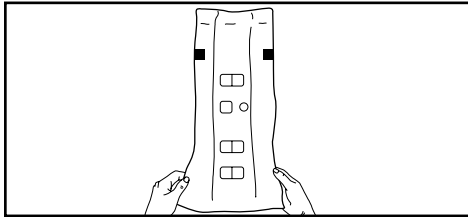

3)

- Spread out new dust bag, taking care not to tear bag.



4)

- Attach new dust bag onto bag holder by holding cardboard portion and pushing back.

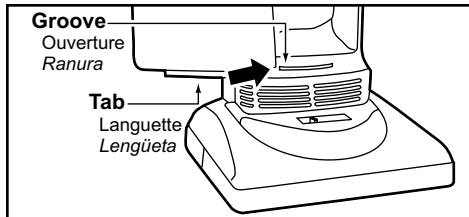

5)

- Reinsert tab on end of dust cover into groove on dust compartment to allow cover to rotate closed.

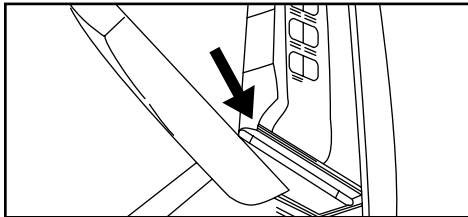

6)

- Rotate dust cover up into closed position and press into place without pinching dust bag.



WARNING *Electrical Shock or Personal Injury Hazard*

*Disconnect the electrical supply before servicing or cleaning the unit.
Failure to do so could result in electrical shock or personal injury from cleaner suddenly starting.*

Removing and Installing Lower Plate

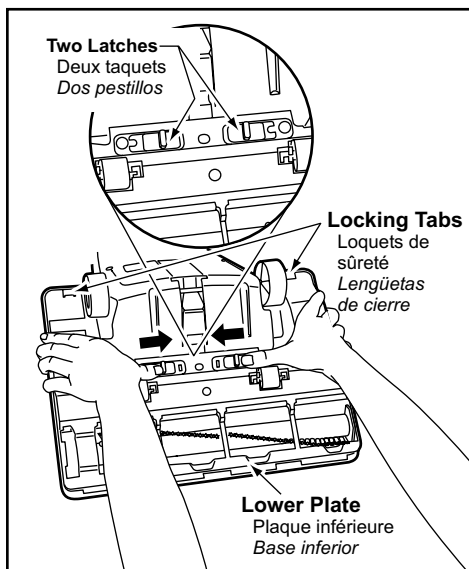

- Always place paper under nozzle whenever lower plate is removed to protect floor.
- Place handle in upright position and turn vacuum over to expose lower plate.
- Release lower plate by pressing two (2) latches and two (2) locking tabs inward as shown.
- Remove lower plate and remove any residue that may exist in belt area.
- Reinstall lower plate by hooking front end of lower plate into slots on front of nozzle housing.
- Make sure all wires are routed properly and not pinched.
- Press lower plate until locking tabs snap into place then push two (2) latches outward.

Replacing Belt

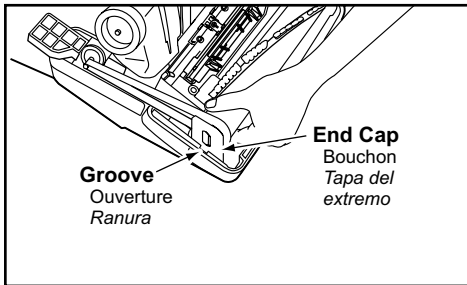
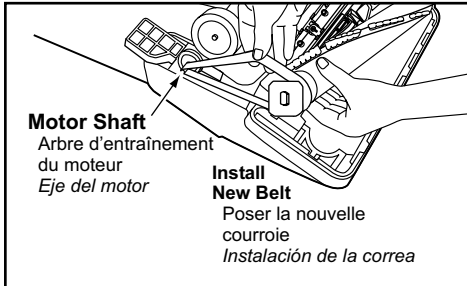
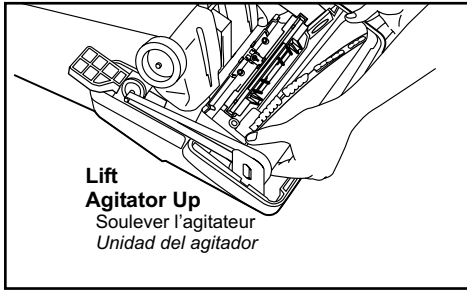

- Replace belt whenever a burning rubber smell caused by excessive slippage occurs.
- Remove lower plate.
- Remove agitator by carefully lifting out.
- Remove worn or broken belt.
- Clean agitator.
- Loop new belt (Panasonic Type UB8 only) around motor shaft and agitator pulley; see illustration for correct belt routing.
- Reinstall agitator back into nozzle housing grooves.
- After reinstalling the agitator, turn it by hand to make sure that belt is not twisted or pinched and that all rotating parts turn freely.
- Reinstall lower plate.

Cleaning Agitator

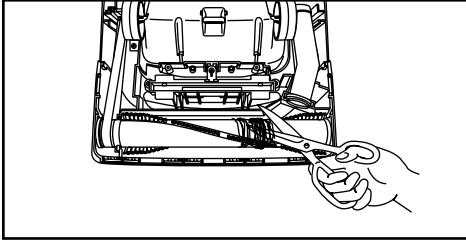

- Clean agitator after every five uses and every time the belt is replaced.
- Remove lower plate.
- Cut off any carpet pile and lint entangled around agitator with a pair of scissors.
- Remove agitator.
- Remove any string or debris located on the end caps, washers or agitator shaft.
- Reinstall agitator and lower plate.

Replacing Agitator

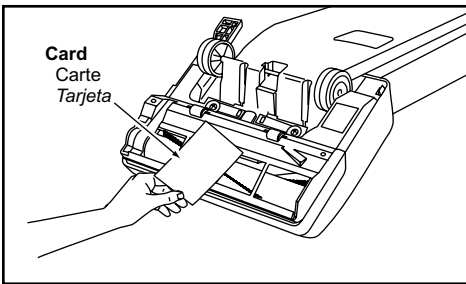

- When the bristles on the agitator are worn so that they do not touch a card held across the lower plate, the agitator should be replaced.
- Remove lower plate and agitator.
- Position belt over belt pulley on the new brush unit.
- Reinstall agitator and lower plate.

Agitator Assembly

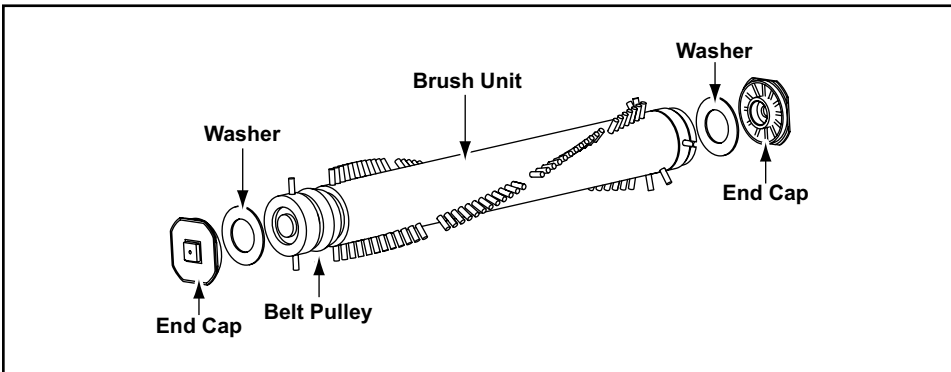

Cleaning Exterior and Tools

- Unplug cord from wall outlet.
- Clean exterior using a clean, soft cloth that has been dipped in a solution of mild liquid detergent and water and wrung dry.
- DO NOT drip water on cleaner and wipe dry after cleaning.
- DO NOT clean tools in dishwasher or clothes washer.
- Wash tools in warm soapy water, rinse and air dry.
- DO NOT use tools if they are wet.

Removing Clogs

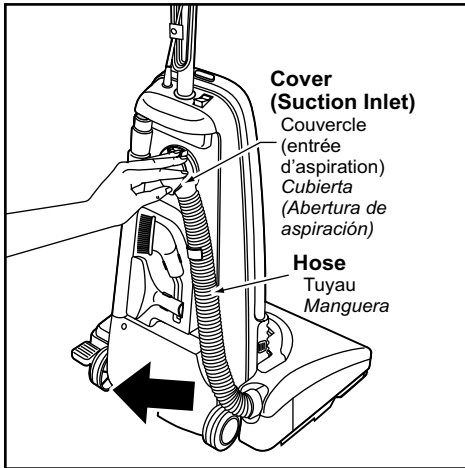

The hose located on the back of the vacuum cleaner carries the dirt from the nozzle up to the dust bag. If the hose should become clogged:

- Unplug vacuum.
- Pull open suction inlet cover and check for clogging.
- Disconnect wand from short hose and check the wand and hose.
- Plug in vacuum cleaner and turn on.

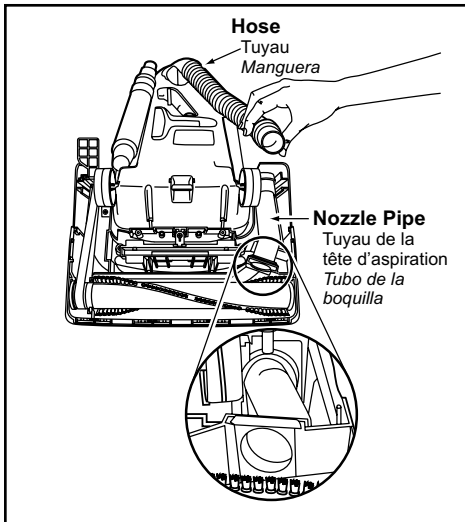

- Disconnect wand and stretch hose in and out to remove clog.
- If clog still exists, turn vacuum cleaner OFF and UNPLUG POWER CORD.
- Turn vacuum over and inspect agitator area for clogs.

BEFORE REQUESTING SERVICE



WARNING *Electric Shock or Personal Injury Hazard.*

Disconnect the electrical supply before servicing or cleaning the unit. Failure to do so could result in electric shock or personal injury from cleaner suddenly starting.

Review this chart to find do-it-yourself solutions for minor performance problems. Any service needed, other than those described in these Operating Instructions, should be performed by an authorized service representative.

PROBLEM	POSSIBLE CAUSE	POSSIBLE SOLUTION
Cleaner will not run.	<ol style="list-style-type: none"> 1. Unplugged at wall outlet. 2. ON-OFF switch not turned on. 3. Tripped circuit breaker/blown fuse at household service panel. 	<ol style="list-style-type: none"> 1. Plug in firmly. Push ON-OFF switch to ON. 2. Push ON-OFF switch to ON. 3. Reset circuit breaker or replace fuse.
Poor job of dirt pickup.	<ol style="list-style-type: none"> 1. Full or clogged dust bag. 2. Broken belt. 3. Carpet height selector incorrect. 4. Clogged hose or nozzle. 5. Hose not inserted fully. 6. Worn agitator. 7. Hole in hose. 8. Dust cover improperly installed. 9. Belt not installed on motor shaft. 	<ol style="list-style-type: none"> 1. Change bag. 2. Replace belt. 3. Set in the correct position. 4. Clean hose or nozzle area. 5. Insert hose. 6. Replace agitator. 7. Replace hose. 8. Properly install dust cover. 9. Install belt on motor shaft.
Dust escapes the paper bag.	<ol style="list-style-type: none"> 1. Bag improperly installed. 2. Bag torn. 	<ol style="list-style-type: none"> 1. Properly install bag. 2. Replace bag.
Cleaner picks up moveable rugs or pushes too hard.	<ol style="list-style-type: none"> 1. Wrong pile height setting. 	<ol style="list-style-type: none"> 1. Adjust setting.

WARRANTY

Panasonic Commercial Vacuum Cleaner Limited Warranty

Panasonic Home and Commercial Products Company (referred to as "the warrantor") will repair this product with new or refurbished parts free of charge, in the U.S.A. or Puerto Rico, for one (1) year from the date of original purchase, in the event of a defect in materials or workmanship.

This Limited Warranty Excludes both Labor and Parts for the following items: disposable dust bags, filters, belts, light bulbs, agitator brushes and batteries (if supplied).

Carry-in or mail-in service in the U.S.A. can be obtained during the warranty period by contacting a Panasonic Services Company (PASC) Factory Servicenter listed in the Servicenter Directory, or by calling toll free, 1-888-350-9590, or by contacting your selling distributor. Carry-in or mail-in service in Puerto Rico can be obtained during the warranty period by calling the local Panasonic Sales Company telephone number listed in the Servicenter Directory.

This warranty is extended only to the original purchaser. A purchase receipt or other proof of date of original purchase will be required before warranty performance is rendered.

This warranty only covers failures due to defects in materials and workmanship which occur during normal use and does not cover damages which occur in shipment, or failures which are caused by products not supplied by the warrantor, or failures which result from accident, misuse, abuse, neglect, mishandling, misapplication, faulty installation, improper operation or maintenance, alteration, modification, power line surge, improper voltage supply, lightning damage, or service by anyone other than a Panasonic Authorized Servicenter, or damage that is attributable to acts of God.

LIMITS AND EXCLUSIONS:

There are no express warranties except as listed above.
THE WARRANTOR SHALL NOT BE LIABLE FOR INCIDENTAL OR CONSEQUENTIAL DAMAGES RESULTING FROM THE USE OF THIS PRODUCT, OR ARISING OUT OF ANY BREACH OF THIS WARRANTY. ALL EXPRESS AND IMPLIED WARRANTIES, INCLUDING THE WARRANTIES OF MERCHANTABILITY AND FITNESS FOR A PARTICULAR PURPOSE, ARE LIMITED TO THE APPLICABLE WARRANTY PERIOD SET FORTH ABOVE.

Some states do not allow the exclusion or limitation of incidental or consequential damages, or limitations on how long an implied warranty lasts, so the above exclusions or limitations may not apply to you.

This warranty gives you specific legal rights and you may also have other rights which vary from state to state. If a problem with this product develops during or after the warranty period, you may contact your dealer or Servicenter. If the problem is not handled to your satisfaction, then write to the Customer Satisfaction Center at the listed address on the back cover.

WARRANTY

Panasonic Canada Inc.

5770 Ambler Drive, Mississauga, Ontario L4W 2T3

PANASONIC PRODUCT - LIMITED WARRANTY

Panasonic Canada Inc. warrants this product to be free from defects in material and workmanship and agrees to remedy any such defect for a period as stated below from the date of original purchase.

Commercial Vacuum Cleaner - Ninety (90) days parts and labour

LIMITATIONS AND EXCLUSIONS

This warranty does not apply to products purchased outside Canada or to any product which has been improperly installed, subjected to usage for which the product was not designed, misused or abused, damaged during shipping, or which has been altered or repaired in any way that affects the reliability or detracts from the performance. Parts such as disposable dust bags, filters, belts, light bulbs and agitator brushes are also excluded from coverage under this warranty.

This warranty is extended to the original end user purchaser only. A purchase receipt or other proof of date of original purchase is required before warranty service is performed.

THIS EXPRESS, LIMITED WARRANTY IS IN LIEU OF ALL OTHER WARRANTIES, EXPRESS OR IMPLIED, EXCLUDING ANY IMPLIED WARRANTIES OF MERCHANTABILITY OR FITNESS FOR A PARTICULAR PURPOSE. IN NO EVENT WILL PANASONIC CANADA INC. BE LIABLE FOR ANY SPECIAL, INDIRECT OR CONSEQUENTIAL DAMAGES.

In certain instances, some jurisdictions do not allow the exclusion or limitation of incidental or consequential damages, or the exclusion of implied warranties, so the above limitations and exclusions may not be applicable.

WARRANTY SERVICE

For product operation and information assistance, please contact your Dealer or our Customer Care Centre at:

Telephone #: (905) 624-5505 Fax #: (905) 238-2360 Web: www.panasonic.ca

For product repairs, please contact one of the following:

- Your Dealer who will inform you of an authorized Servicentre nearest you.
- Our Customer Care Centre at (905) 624-5505 or www.panasonic.ca
- A Panasonic Factory Servicentre listed below:

Richmond, British Columbia

Panasonic Canada Inc.
12111 Riverside Way
Richmond, BC V6W 1K8
Tel: (604) 278-4211
Fax: (604) 278-5627

Calgary, Alberta

Panasonic Canada Inc.
6835-8th St. N.E.
Calgary, AB T2E 7H7
Tel: (403) 295-3955
Fax: (403) 274-5493

Mississauga, Ontario

Panasonic Canada Inc.
5770 Ambler Dr.
Mississauga, ON L4W 2T3
Tel: (905) 624-8447
Fax: (905) 238-2418

Lachine, Québec

Panasonic Canada Inc.
3075, rue Louis A. Amos
Lachine, QC H8T 1C4
Tel: (514) 633-8684
Fax: (514) 633-8020

IF YOU SHIP THE PRODUCT TO A SERVICENTRE

Carefully pack and send prepaid, adequately insured and preferably in the original carton.

Include details of the defect claimed, and proof of date of original purchase.

Ref: VAC_Commercialwar02/03

WHAT TO DO WHEN SERVICE IS NEEDED

If your Panasonic Vacuum Cleaner needs service, look in the yellow pages of the telephone book under HOME APPLIANCE SERVICE for your nearest Panasonic Services Company ("PASC") Factory Servicenter, or PASC authorized Servicenter, or call, 1-800-211-PANA (7262) toll free to find a convenient servicenter. **DO NOT send the product to the Executive or Regional Sales Offices. They are NOT equipped to make repairs.**

If you ship the product

Carefully pack and send it prepaid, adequately insured and preferably in the original carton. Attach a postage-paid letter to the outside of the carton, which contains a description of your complaint. **DO NOT send the product to the Executive or Regional Sales Offices. They are NOT equipped to make repairs.**

**PANASONIC CONSUMER ELECTRONICS COMPANY
DIVISION OF MATSUSHITA ELECTRIC CORPORATION OF AMERICA**

One Panasonic Way
Secaucus, New Jersey 07094
World Wide Web Address
<http://www.panasonic.com>

What to do when service is needed Service après-vente (Canada)

WARRANTY SERVICE

For product operation and information assistance, please contact your Dealer or our Customer Care Centre at:
Telephone #: (905) 624-5505 Fax #: (905) 238-2360 Web: www.panasonic.ca

For product repairs, please contact one of the following:

- Your Dealer who will inform you of an authorized Servicenter nearest you.
- Our Customer Care Centre at (905) 624-5505 or www.panasonic.ca
- A Panasonic Factory Servicenter listed on warranty page.

RÉPARATION SOUS GARANTIE

Pour de l'aide sur le fonctionnement de l'appareil ou pour toute demande d'information, veuillez contacter votre détaillant ou notre service à la clientèle au :

N° de téléphone : (905) 624-5505 N° de télécopieur : (905) 238-2360 Site Internet : www.panasonic.ca

Pour la réparation des appareils, veuillez consulter :

- votre détaillant, lequel pourra vous renseigner sur le centre de service agréé le plus près de votre domicile ;
- notre service à la clientèle au (905) 624-5505 ou www.panasonic.ca;
- un de nos centres de service indiqués sur la page de garantie.

Quando necesita servicio

Si su aspiradora Panasonic necesita servicio, busque el Centro de Servicio Panasonic o un Centro de Servicio PASC autorizado más cercano bajo "Servicio de Electrodomésticos" en las páginas amarillas de la guía de teléfonos o llame gratis al 1-800-211-PANA (7262) para encontrar un centro de servicio conveniente. **No mande el producto a las Executive o Regional Sales Offices. No están equipadas para arreglar estos productos.**

Si manda el producto

Empaquete con cuidado en el cartón original si posible y mándelo prepagado y con seguro suficiente. Ponga una carta con sellos en la que describe su problema con el producto en el exterior del cartón. **No mande el producto a las Executive o Regional Sales Offices. No están equipadas para arreglar estos productos.**

**PANAMEX COMPANY
DIVISION OF MATSUSHITA ELECTRIC CORPORATION OF AMERICA**

One Panasonic Way
Secaucus, New Jersey 07094
World Wide Web Address
<http://www.panasonic.com>

AC01ZCDHZ000
C01ZCDH00000

Printed in Mexico
Impreso en Mexico
Imprimé au Mexique