

This Owner's Manual is provided and hosted by [Appliance Factory Parts](#).



# PANASONIC MC-V5241 Owner's Manual

[Shop genuine replacement parts for PANASONIC  
MC-V5241](#)



[Find Your PANASONIC Vacuum Cleaner Parts - Select From 605 Models](#)

----- Manual continues below -----

# Panasonic®

VACUUM CLEANER

Aspirateur

*Aspiradora*

## MC-V5241

**Operating Instructions**

Manuel d'utilisation

*Instrucciones de operación*

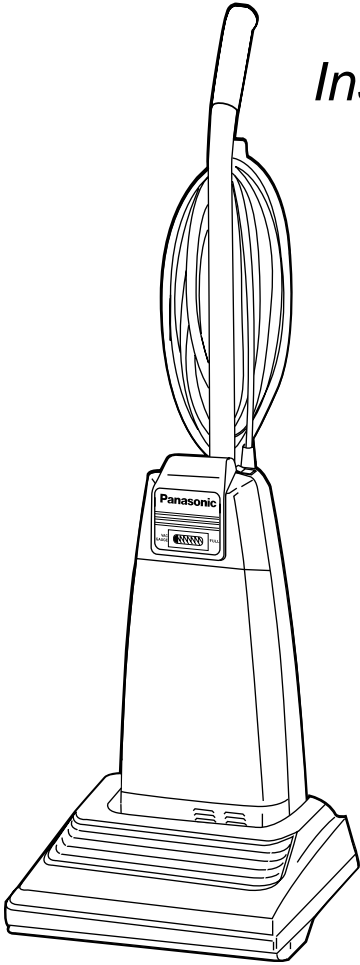

**Before operating your vacuum cleaner,  
please read these instructions completely.**

Avant d'utiliser l'appareil, il est recommandé  
de lire attentivement ce manuel.

*Antes de usar su aspiradora, lea  
completamente estas instrucciones por favor.*

# CONSUMER INFORMATION

Please read **IMPORTANT SAFETY INSTRUCTIONS** on page 5 before use. Read and understand all instructions.

## TO OUR VALUED CUSTOMER

We are very pleased to welcome you to the Panasonic family of products. Thank you for purchasing this product. Our intent is that you become one of our many satisfied customers.

**Proper assembly and safe use of your vacuum cleaner are your responsibilities. Your vacuum cleaner is intended only for household use. The vacuum cleaner should be stored in a dry, indoor area. Read the Operating Instructions carefully for important use and safety information.**

**Special care is required when vacuuming certain types of carpet or floor covering. Always check the carpet or floor covering manufacturer's recommended cleaning instructions before vacuuming.**

## PLEASE PAY CLOSE ATTENTION TO ALL WARNING AND CAUTION STATEMENTS.

### **WARNING**

**WARNING** statements are designed to alert you to the possibility of personal injury, loss of human life, and/or damage to the vacuum cleaner and/or personal property if the instructions given are not followed.

### **CAUTION**

**CAUTION** statements are designed to alert you to the possibility of damage to the vacuum cleaner and/or personal property if the instructions given are not followed.

### **WARNING**

#### **TO AVOID ELECTRICAL SHOCK**

Never vacuum damp or wet surfaces or liquids.  
DO NOT store vacuum cleaner outdoors.  
Replace worn or frayed power cord immediately.  
Unplug from outlet when not in use and before servicing.

#### **TO AVOID ACCIDENTS**

Except for hand-held cleaners, keep vacuum cleaner on floor - not chairs, tables, steps, stairs, etc.  
Store vacuum cleaner promptly after each use to prevent accidents such as tripping over power cord or vacuum cleaner.  
Use vacuum cleaner and accessories only in a manner intended by the manufacturer.  
The use of an extension cord is not recommended.

© 2006 Panasonic Home Appliances Company of North America,

Division of Panasonic Corporation of North America. All rights reserved.

# IMPORTANT SAFETY INSTRUCTIONS

When using your vacuum cleaner, basic precautions should always be followed, including the following:

Read all instructions in this manual before assembling or using your vacuum cleaner.

## **WARNING** To reduce the risk of fire, electrical shock, injury:

1. **Read** all instructions in this manual before assembling or using your vacuum cleaner.
2. **Use** your vacuum cleaner only as described in this manual. Use only with Panasonic recommended attachments.
3. **Disconnect** electrical supply before servicing or cleaning out the brush area. Failure to do so could result in the brush unexpectedly starting, causing personal injury from moving parts.
4. **Do not** leave vacuum cleaner when plugged in. Unplug from outlet when not in use and before servicing.
5. **To reduce** the risk of electrical shock - Do not use outdoors or on wet surfaces.
6. **Do not** allow to be used as a toy. Close attention is necessary when used by or near children.
7. **Do not** use with a damaged cord or plug. If vacuum cleaner is not working as it should, has been dropped, damaged, left outdoors, or dropped in water, return it to a Panasonic Service Center.
8. **Do not** pull or carry by cord, use cord as a handle, close a door on cord, or pull cord around sharp edges or corners. Do not run vacuum cleaner over cord. Keep cord away from heated surfaces.
9. **Do not** unplug by pulling on cord. To unplug, grasp the plug, not the cord.
10. **Do not** handle plug or vacuum cleaner with wet hands.
11. **Do not** put any objects into openings.
12. **Do not** use with any opening blocked; keep free of dust, lint, hair, and anything that may reduce air flow.
13. **Keep** hair, loose clothing, fingers, and all parts of body away from openings and moving parts.
14. **Turn off** all controls before unplugging.
15. **Use** extra care when cleaning on stairs. Do not put on chairs, tables, etc. Keep on floor.
16. **Do not** use vacuum cleaner to pick up flammable or combustible liquids (gasoline, cleaning fluid, perfumes, etc.), or use in areas where they may be present. The fumes from these substances can create a fire hazard or explosion.
17. **Do not** pick up anything that is burning or smoking, such as cigarettes, matches, or hot ashes.
18. **Do not** use vacuum cleaner without dust bag and/or filters in place.
19. **You are** responsible for making sure that your vacuum cleaner is not used by anyone unable to operate it properly.

## SAVE THESE INSTRUCTIONS

### THIS VACUUM CLEANER IS INTENDED FOR HOUSEHOLD USE ONLY

**NOTE:** Before you plug in your Panasonic vacuum cleaner, make sure that the voltage indicated on the rating plate located at the back of the vacuum cleaner is the same as your local electrical supply.

## TABLE OF CONTENTS

CONSUMER INFORMATION .....	2
IMPORTANT SAFETY INSTRUCTIONS .....	5
PARTS IDENTIFICATION .....	10
ASSEMBLY .....	12
Attaching Handle .....	12
FEATURES .....	14
Using Cord Hook .....	14
Automatic Self Adjusting Nozzle .....	14
Edge Cleaning .....	14
Vac Gauge .....	16
Thermal Protector .....	16
TO OPERATE VACUUM CLEANER .....	18
Power Cord .....	18
ON-OFF Switch .....	18
Handle Adjustments .....	18
ROUTINE CARE OF VACUUM CLEANER .....	20
Replacing Secondary HEPA Filter .....	20
Changing Dust Bag .....	20, 22
Removing and Installing Lower Plate .....	24
Replacing Headlight Bulb .....	26
Replacing Belt .....	26, 28
Cleaning Agitator .....	28
Replacing Brushes .....	30
Agitator Assembly .....	32
Cleaning Exterior and Tools .....	32
Removing Clogs .....	34
BEFORE REQUESTING SERVICE .....	36
WARRANTY .....	39, 41
WHAT TO DO WHEN SERVICE IS NEEDED .....	44

## FEATURE CHART

Power	Thermal Protector	Cord Length	Tools
120V AC (60Hz)	Yes	9.1 m (30 Ft.)	Optional

## Tableau des caractéristiques

Alimentation	Protecteur thermique	Longueur du cordon	Accessoires
120 V c.a. (60Hz)	Oui	9,1 m (30 pi)	Optionnels

## Diagrama de características

<i>Voltaje</i>	<i>Protector termal</i>	<i>Extensión de cordón</i>	<i>Herramientas</i>
120 V c.a. (60Hz)	Si	9,1 m (30 pi)	Opcional

# ASSEMBLY

## Attaching Handle

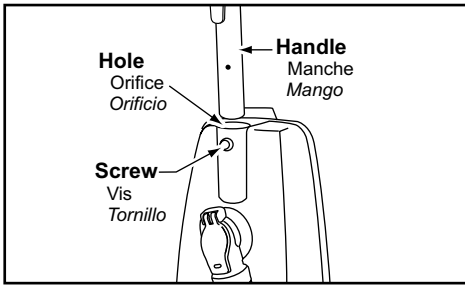

1)

- **DO NOT** plug in until assembly is complete.
- Remove handle screw.
- Insert handle with cord hooks to the back of the vacuum cleaner.

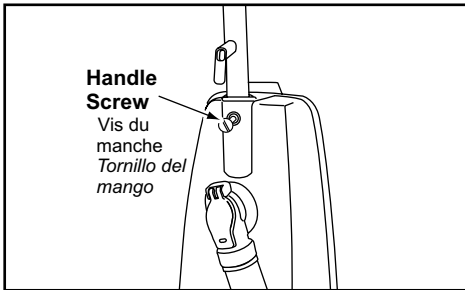

2)

- Insert screw.
- Tighten screw.

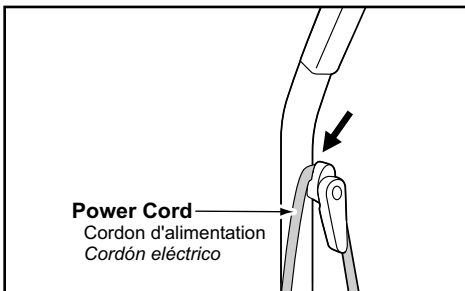

3)

- Push power cord into cord clip.

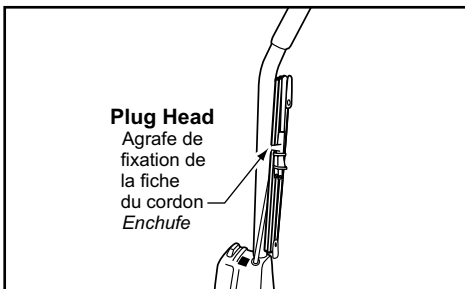

4)

- Wrap power cord around cord hooks.
- Secure retainer (plug head) to power cord.

## FEATURES

### Using Cord Hook

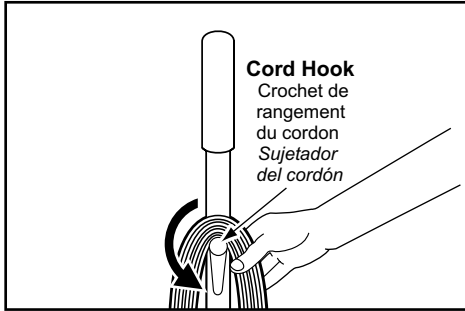

1)

- Detach plug head from power cord.
- Rotate cord hook down to release cord.

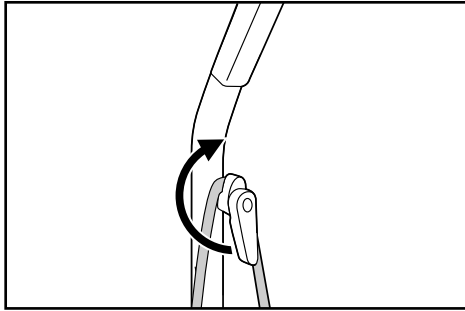

2)

- Return the cord hook to the upright position before attempting to rewind the cord.

### Automatic Self Adjusting Nozzle

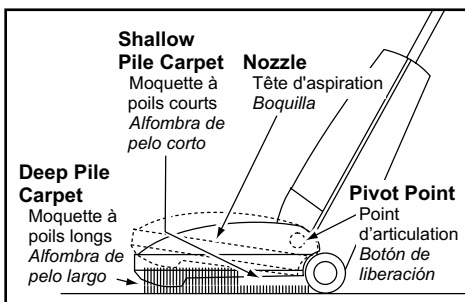

- The nozzle of your Panasonic upright vacuum cleaner automatically adjusts to any carpet pile height.
- Feature allows nozzle to float evenly over carpet pile surfaces.
- No manual adjustments required.

### Edge Cleaning

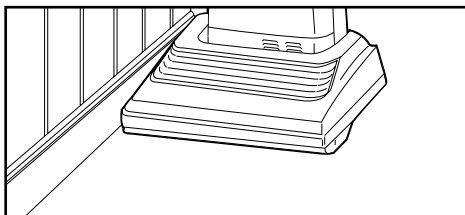

- Edge cleaning feature enables improved cleaning of carpets near walls and furniture.



## Vac Gauge

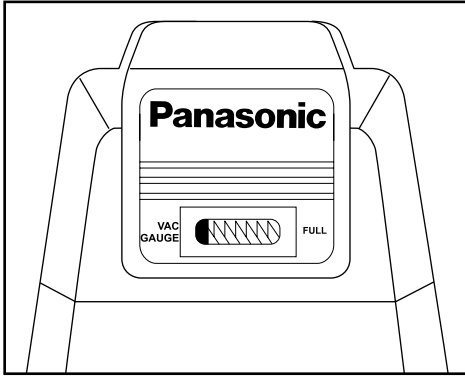

- The vac gauge detects when dust bag needs changing or the vacuum cleaner is clogged.
- Check dust bag when vac gauge indicates FULL.
- If dust bag is full, change bag according to **CHANGING DUST BAG** section.
- If dust bag is not full, check for clogs according to **REMOVING CLOGS** section.

## Thermal Protector

- If a clog prevents the normal flow of air to the motor, the thermal protector turns the motor off automatically to allow the motor to cool in order to prevent possible damage to the vacuum cleaner.
- During this time the headlight remains on.
- To correct problem, turn off and unplug vacuum cleaner, remove clogs, and/or clean/replace filters.
- Replace full bag if necessary.
- Wait approximately thirty (30) minutes, plug vacuum cleaner in, turn on to see if thermal protector has reset. Thermal protector will not reset if vacuum cleaner is not turned off even if vacuum cleaner cools down.

## TO OPERATE VACUUM CLEANER

### Power Cord

**NOTE:** To reduce the risk of electrical shock, this vacuum cleaner has a polarized plug, one blade is wider than the other. This plug will fit in a polarized outlet only one way. If the plug does not fit fully in the outlet, reverse the plug. If it still does not fit, contact a qualified electrician to install the proper outlet. **DO NOT CHANGE THE PLUG IN ANY WAY.** Only use outlets near the floor.

### ON-OFF Switch

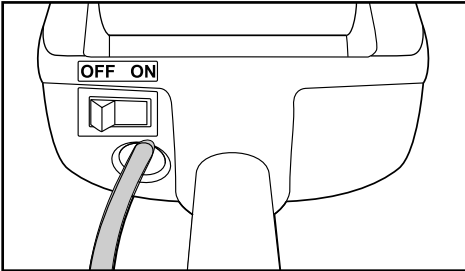

- Ensure ON-OFF switch is OFF.
- Plug the power cord into 120V outlet.
- ON position turns vacuum cleaner on.
- OFF position turns vacuum cleaner off.

### Handle Adjustments

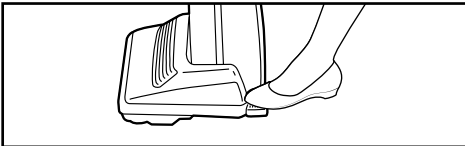

- 1)
- Step on handle release pedal to change handle position.

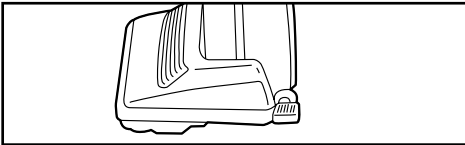

- 2)
- Move vacuum cleaner to upright position for storage and tool use.

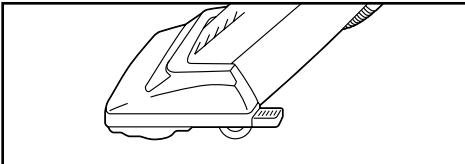

- 3)
- Move vacuum cleaner to middle position for normal use.

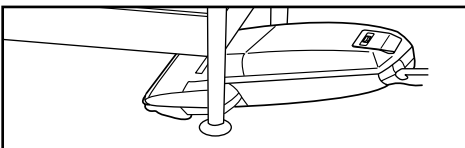

- 4)
- Use low position for cleaning under furniture.

## ROUTINE CARE OF VACUUM CLEANER

Performing the following tasks will keep your new Panasonic vacuum cleaner operating at peak performance levels and will ensure these high levels for years to come. Check the **BEFORE REQUESTING SERVICE** section in this manual for recommendations on performing some of these tasks to help solve various problems that may occur.

### Replacing Secondary HEPA Filter

#### Secondary HEPA Filter (White Side Up)

Filtre secondaire de type HEPA  
(Côté blanc sur le dessus)  
Filtro de HEPA secundario  
(Blanca hacia arriba)

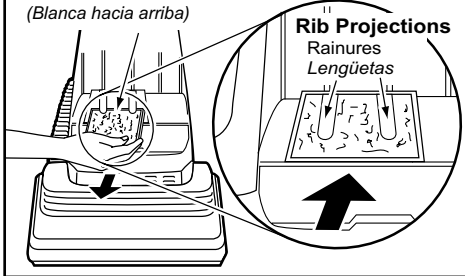

- Secondary HEPA filter protects the motor.
- Check filter when installing a new dust bag.
- If dirty, pull filter from bottom of dust compartment and replace.
- Place new filter, white side up, in dust compartment, **DO NOT CLEAN WITH WATER\***.
- Ensure filter is fully inserted under plastic rib projections.

\*Filter cannot be cleaned and should be replaced at least once each year.

### Changing Dust Bag

Always operate vacuum cleaner with genuine Panasonic Type U3 Standard or U6 Electrostatic dust bags installed. Panasonic dust bags may be purchased through any authorized Panasonic dealer or ordered from service company.

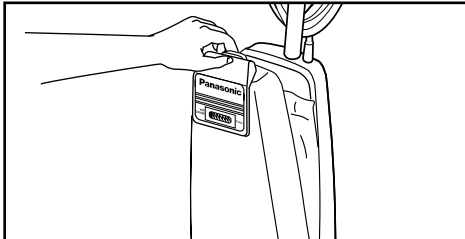

- 1)
- Pull outward on dust cover grip to remove the dust cover.

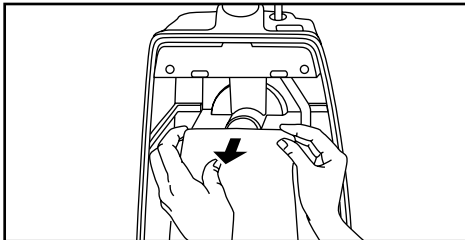

- 2)
- Remove dust bag by grasping cardboard portion and pulling out.

## Changing Dust Bag

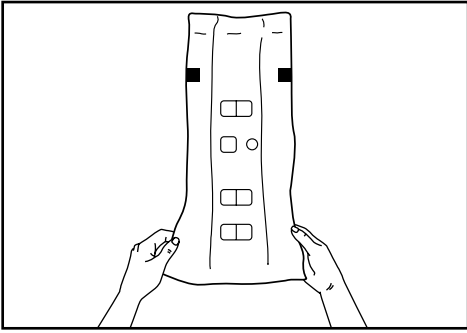

3)

- Spread out new dust bag, taking care not to tear bag.

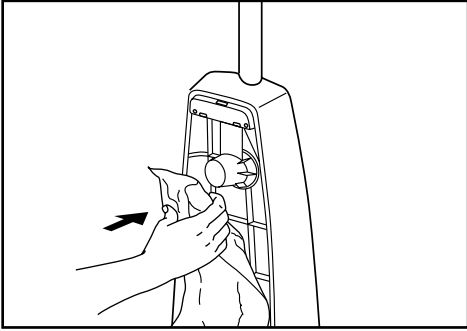

4)

- Attach new dust bag onto bag holder by holding cardboard portion and pushing back.

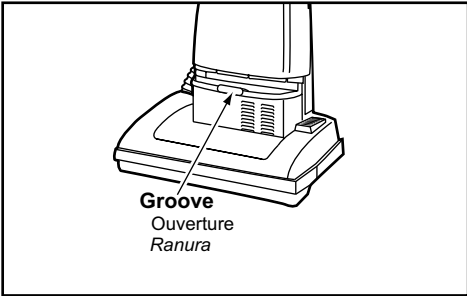

5)

- Reinsert tab on end of dust cover into groove on dust compartment to allow cover to rotate closed.

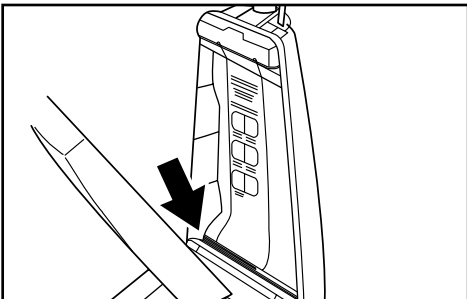

6)

- Rotate dust cover up into closed position and press into place without pinching dust bag.

**! WARNING** Electrical Shock or Personal Injury Hazard

Disconnect the electrical supply before servicing or cleaning the vacuum cleaner. Failure to do so could result in electrical shock or personal injury from vacuum cleaner suddenly starting.

### Removing and Installing Lower Plate

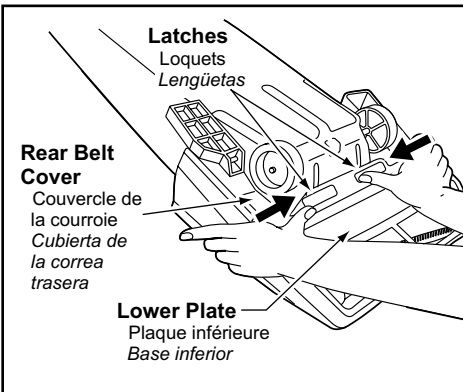

- **Before servicing any parts, disconnect vacuum cleaner from electrical outlet.**
- **Place paper under nozzle any time lower plate is removed to protect floor.**
- **Place handle in upright position and turn vacuum cleaner over to expose lower plate.**
- **Release lower plate by pressing two (2) latches inward.**
- **Remove lower plate and remove any residue that may exist in belt area.**
- **Close the rear belt cover and reinstall lower plate by hooking front end of lower plate into slots on front of nozzle housing.**
- **Make sure all wires are routed properly and not pinched.**
- **Press lower plate into place then push two (2) latches outward.**

## Replacing Headlight Bulb

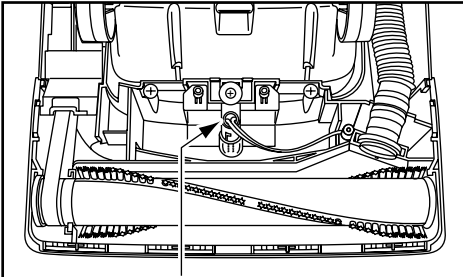

**Bulb Socket Assembly**  
Assemblage de la lampe  
Casquillo portalámparas

- Remove lower plate.
- Remove bulb socket screw, grasp the bulb socket assembly and pull upward while moving it back and forth.
- Remove old bulb from the bulb socket assembly by pushing in while turning counter-clockwise.
- Replace bulb by pushing in while turning clockwise.
- Only use a bulb rated 130 V AC-15 Watts or less.
- Reinstall bulb socket assembly into nozzle housing by pushing it back down into slot and reinstall bulb socket screw.
- Reinstall lower plate.

## Replacing Belt

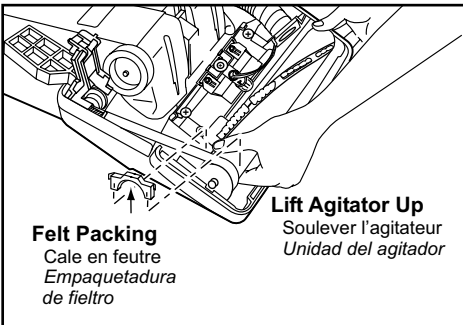

**Felt Packing**  
Cale en feutre  
Empaquetadura  
de fieltro

**Lift Agitator Up**  
Soulever l'agitateur  
Unidad del agitador

- Replace belt whenever a burning rubber smell caused by excessive slippage occurs.
- Remove lower plate.
- Lift rear belt cover and remove felt packing.
- Remove agitator by carefully lifting out.
- Remove worn or broken belt.
- Clean agitator.
- Loop new belt (Panasonic Type UB8 only) around motor shaft and agitator pulley; see illustration for correct belt routing.

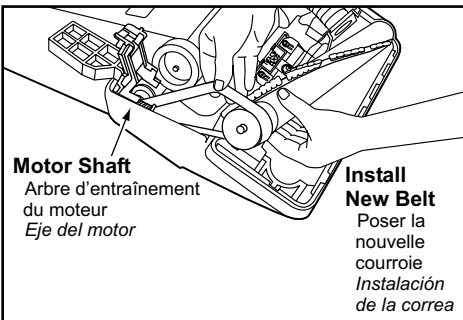

**Motor Shaft**  
Arbre d'entraînement  
du moteur  
Eje del motor

**Install  
New Belt**  
Poser la  
nouvelle  
courroie  
Instalación  
de la correa

## Replacing Belt

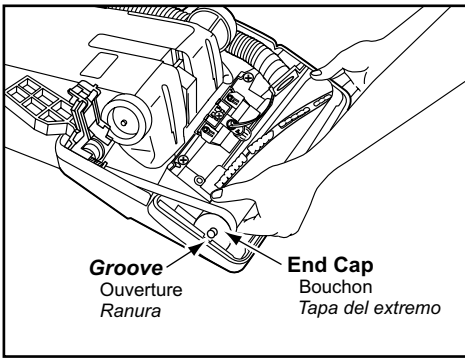

- Reinstall agitator back into nozzle housing grooves.
- Close rear belt cover and reinstall felt packing.
- After reinstalling the agitator, turn it by hand to make sure that belt is not twisted or pinched and that all rotating parts turn freely.
- Reinstall lower plate.

## Cleaning Agitator

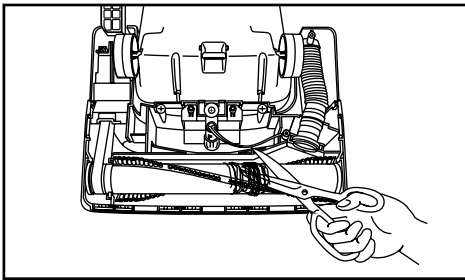

- Clean agitator after every five uses and every time the belt is replaced.
- Remove lower plate.
- Cut off any carpet pile and lint entangled around agitator with a pair of scissors.
- Remove agitator.
- Remove any string or debris located on the end caps, washers or agitator shaft.
- Reinstall agitator and lower plate.

## Replacing Brushes

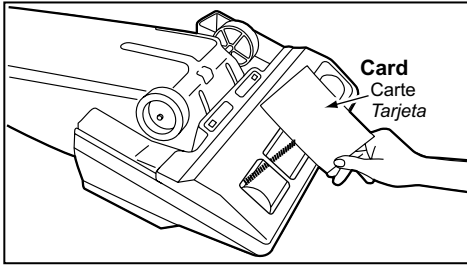

- When the bristles on the agitator are worn so that they do not touch a card held across the lower plate, the brushes should be replaced.
- Remove lower plate and agitator.

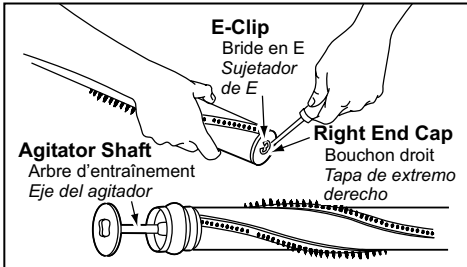

- Remove the E-clip from agitator shaft and end cap.
- Do not bend agitator shaft or lose E-clip.
- Pull agitator shaft out of agitator body.

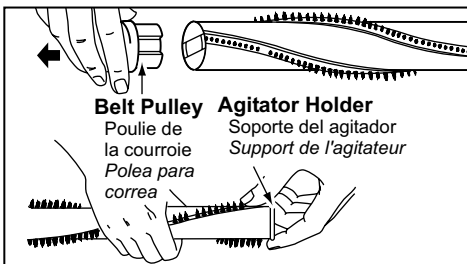

- Pull, or pry out, agitator holder and agitator pulley.
- Push each brush out of agitator body as shown.
- Install new brushes by reversing procedure.
- Reinstall agitator holder and agitator pulley completely.

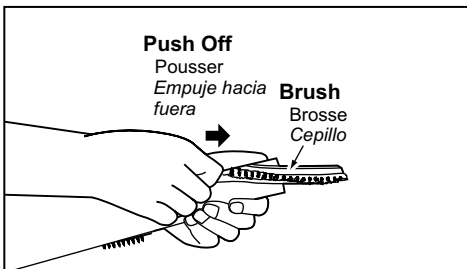

- Reinstall the agitator shaft, end cap and E-clip.
- See exploded view on page 32 for correct assembly of parts.
- Position belt over agitator pulley on the agitator.
- Reinstall agitator and lower plate.



## Agitator Assembly

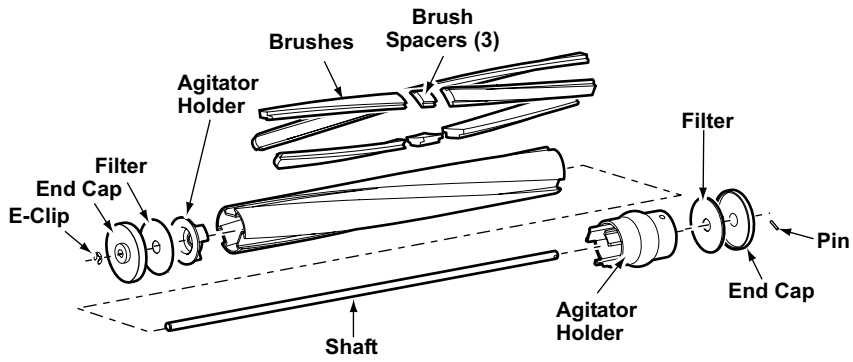

## Cleaning Exterior and Tools

- Unplug cord from wall outlet.
- Clean exterior using a clean, soft cloth that has been dipped in a solution of mild liquid detergent and water and wrung dry.
- DO NOT drip water on vacuum cleaner and wipe dry after cleaning.
- DO NOT clean tools in dishwasher or clothes washer.
- Wash tools in warm soapy water, rinse and air dry.
- DO NOT use tools if they are wet.

## Removing Clogs

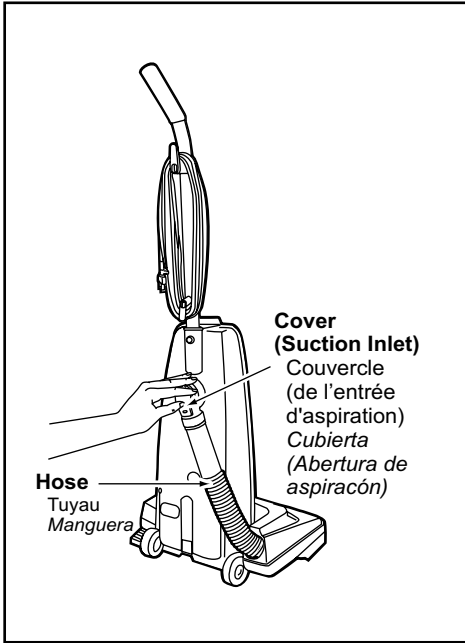

The hose located on the back of the vacuum cleaner carries the dirt from the nozzle up to the dust bag. If the hose should become clogged:

- Unplug vacuum cleaner.
- Pull open suction inlet cover and check for clogging.
- Remove lower plate.
- Remove hose from nozzle by lifting straight up.

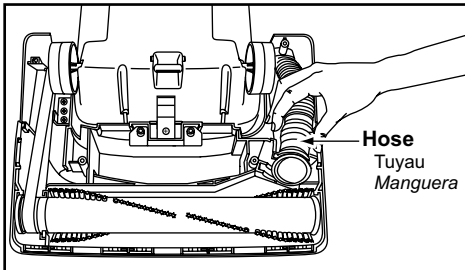

- Inspect hose end and clear any obstructions.
- Reinstall hose and lower plate.

## BEFORE REQUESTING SERVICE

### **WARNING** Electrical Shock or Personal Injury Hazard

Disconnect the electrical supply before servicing or cleaning the vacuum cleaner. Failure to do so could result in electrical shock or personal injury from vacuum cleaner suddenly starting.

Review this chart to find do-it-yourself solutions for minor performance problems. Any service needed, other than those described in these Operating Instructions, should be performed by an authorized service representative.

PROBLEM	POSSIBLE CAUSE	POSSIBLE SOLUTION
<b>Vacuum Cleaner will not run.</b>	<ol style="list-style-type: none"> <li>1. Unplugged at wall outlet.</li> <li>2. ON-OFF switch not turned on.</li> <li>3. Tripped circuit breaker/blown fuse at household service panel.</li> </ol>	<ol style="list-style-type: none"> <li>1. Plug in firmly. Push ON-OFF switch to On.</li> <li>2. Push ON-OFF switch to ON.</li> <li>3. Reset circuit breaker or replace fuse.</li> </ol>
<b>Poor job of dirt pickup.</b>	<ol style="list-style-type: none"> <li>1. Full or clogged dust bag.</li> <li>2. Broken belt.</li> <li>3. Clogged hose or nozzle.</li> <li>4. Hose not inserted fully.</li> <li>5. Worn agitator.</li> <li>6. Hole in hose.</li> <li>7. Dust cover improperly installed.</li> </ol>	<ol style="list-style-type: none"> <li>1. Change bag.</li> <li>2. Replace belt.</li> <li>3. Clean hose or nozzle area.</li> <li>4. Insert hose.</li> <li>5. Replace agitator.</li> <li>6. Replace hose.</li> <li>7. Properly install dust cover.</li> </ol>
<b>Dust escapes the paper bag.</b>	<ol style="list-style-type: none"> <li>1. Bag improperly installed.</li> <li>2. Bag torn.</li> </ol>	<ol style="list-style-type: none"> <li>1. Properly install bag.</li> <li>2. Replace bag.</li> </ol>

# WARRANTY

## Panasonic Platinum Series Vacuum Cleaner Limited Warranty

Panasonic Consumer Electronics Company (collectively referred to as "the warrantor") will repair this product with new or refurbished parts free of charge, in the U.S.A. or Puerto Rico for two (2) years from the date of original purchase in the event of a defect in materials or workmanship.

**This Limited Warranty Excludes both Labor and Parts for the following items which require normal replacement:** Disposable Dust Bag, Filters, Belts, Light Bulbs, Agitator Brushes and Batteries (if supplied).

Carry-in or mail-in service in the U.S.A. can be obtained during the warranty period by contacting a Panasonic Services Company (PASC) Factory Servicenter listed in the Servicenter Directory. Or call, toll free, 1-800-211-PANA (7262) to locate a PASC Authorized Servicenter. Carry-in or mail-in service in Puerto Rico can be obtained during the warranty period by calling the local Panasonic Sales Company telephone number listed in the Servicenter Directory.

This warranty is extended only to the original purchaser. A purchase receipt or other proof of date of original purchase will be required before warranty performance is rendered.

This warranty only covers failures due to defects in materials and workmanship which occur during normal use and does not cover damages which occur in shipment, or failures which are caused by products not supplied by the warrantor, or failures which result from accident, misuse, abuse, neglect, mishandling, misapplication, faulty installation, improper operation or maintenance, alteration, modification, power line surge, improper voltage supply, lightning damage, commercial use such as hotel, office, restaurant or other business or rental use of the product, or service by anyone other than a PASC Authorized Servicenter, or damage that is attributable to acts of God.

### **LIMITS AND EXCLUSIONS:**

There are no express warranties except as listed above.

THE WARRANTOR SHALL NOT BE LIABLE FOR INCIDENTAL OR CONSEQUENTIAL DAMAGES RESULTING FROM THE USE OF THIS PRODUCT, OR ARISING OUT OF ANY BREACH OF THIS WARRANTY. ALL EXPRESS AND IMPLIED WARRANTIES, INCLUDING THE WARRANTIES OF MERCHANTABILITY AND FITNESS FOR A PARTICULAR PURPOSE, ARE LIMITED TO THE APPLICABLE WARRANTY PERIOD SET FORTH ABOVE.

Some states do not allow the exclusion or limitation of incidental or consequential damages, or limitations on how long an implied warranty lasts, so the above exclusions or limitations may not apply to you.

This warranty gives you specific legal rights and you may also have other rights which vary from state to state. If a problem with this product develops during or after the warranty period, you may contact your dealer or Servicenter. If the problem is not handled to your satisfaction, then write to the Consumer Affairs Department at the listed address on the back cover.

# WARRANTY

Panasonic Canada Inc.  
5770 Ambler Drive, Mississauga, Ontario L4W 2T3

## Panasonic Platinum Series Vacuum Cleaner Limited Warranty

Panasonic Canada Inc. warrants this product to be free from defects in material and workmanship and agrees to remedy any such defect for a period as stated below from the date of original purchase.

### Vacuum Cleaner - Two (2) year, parts and labour

In-home Service will be carried out only to locations accessible by roads and within 50 km of an authorized Panasonic service facility.

### LIMITATIONS AND EXCLUSIONS

This warranty does not apply to products purchased outside Canada or to any product which has been improperly installed, subjected to usage for which the product was not designed, misused or abused, damaged during shipping, or which has been altered or repaired in any way that affects the reliability or detracts from the performance, nor does it cover any product which is used commercially. Dry cell batteries are also excluded from coverage under this warranty. This warranty is extended to the original end user purchaser only. A purchase receipt or other proof of date of original purchase is required before warranty service is performed.

**THIS EXPRESS, LIMITED WARRANTY IS IN LIEU OF ALL OTHER WARRANTIES, EXPRESS OR IMPLIED, INCLUDING ANY IMPLIED WARRANTIES OF MERCHANTABILITY AND FITNESS FOR A PARTICULAR PURPOSE. IN NO EVENT WILL PANASONIC CANADA INC. BE LIABLE FOR ANY SPECIAL, INDIRECT OR CONSEQUENTIAL DAMAGES.**

In certain instances, some jurisdictions do not allow the exclusion or limitation of incidental or consequential damages, or the exclusion of implied warranties, so the above limitations and exclusions may not be applicable.

### WARRANTY SERVICE

**FOR PRODUCT OPERATION ASSISTANCE**, please contact:

Our Customer Care Centre:	Telephone #:	(905) 624-5505
	1-800 #:	1-800-561-5505
	Fax #:	(905) 238-2360
	Email link:	"Contact Us" on <a href="http://www.panasonic.ca">www.panasonic.ca</a>

**FOR PRODUCT REPAIRS**, please locate your nearest Authorized Servicentre at [www.panasonic.ca](http://www.panasonic.ca) :

Link : "Servicentres<sup>TM</sup> locator" under "Customer support"

### **IF YOU SHIP THE PRODUCT TO A SERVICENTRE**

Carefully pack and send prepaid, adequately insured and preferably in the original carton.  
Include details of the defect claimed, and proof of date of original purchase.