

This Owner's Manual is provided and hosted by [Appliance Factory Parts](#).



PANASONIC NE-1757A Owner's Manual

[Shop genuine replacement parts for PANASONIC
NE-1757A](#)



[Find Your PANASONIC Microwave Parts - Select From 742 Models](#)

----- Manual continues below -----

Owner's Manual

NE-2157A / NE-1757A / NE-1257A / NE-1258A

2100 Watts/1700 Watts/1200 Watts* Heavy Duty
Commercial Microwave Ovens

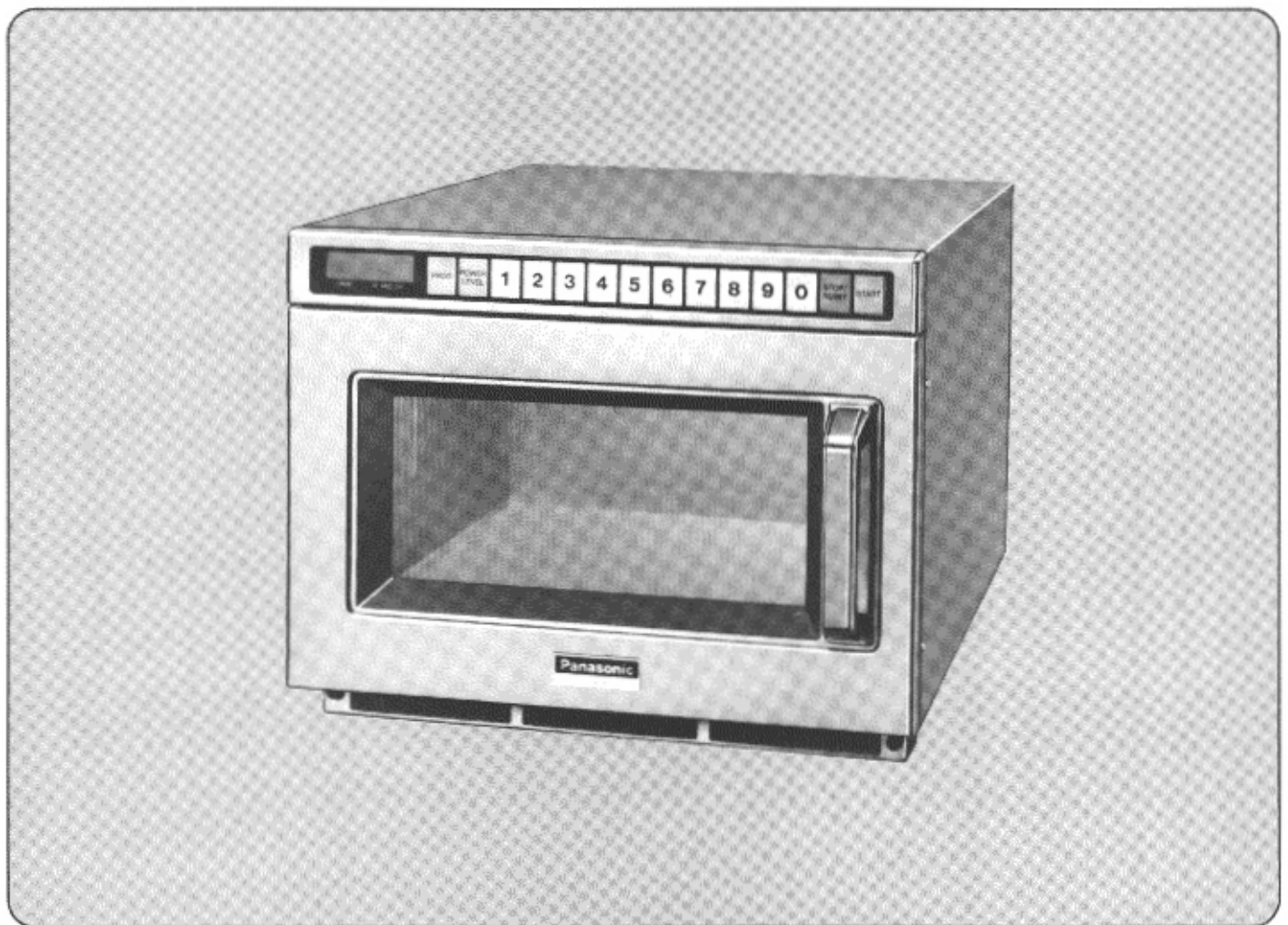

Please read these instructions completely before operating this oven.
*IEC 705-88 Test procedure

Panasonic®

PRECAUTIONS TO AVOID POSSIBLE EXPOSURE TO EXCESSIVE MICROWAVE ENERGY

- (a) **Do not attempt to operate this oven with the door open** since open-door operation can result in harmful exposure to microwave energy. It is important not to defeat or tamper with the safety interlocks.
- (b) **Do not place any object** between the oven front face and the door, or allow soil or cleaner residue to accumulate on sealing surfaces.
- (c) **Do not operate the oven** if it is damaged. It is particularly important that the oven door close properly and that there is no damage to the:
 - (1) door (bent)
 - (2) hinges and latches (broken or loosened)
 - (3) door seals and sealing surfaces
- (d) **The oven should not be adjusted or repaired** by anyone except properly qualified service personnel.

TABLE OF CONTENTS

Operating Instructions		Memory Pad Heating	11
Important Safety Instructions	3	To Read the Cycle Counter	11
Grounding Instructions and Installation	4	To Activate Program Lock	12
Caution	4	To Release Program Lock	12
Power Source Voltage Adjustment	5	To Read Program List	12
How Does The Microwave Work?	5	To Select Beep Tone Options	13
Outline Diagram	6	To Program Air Filter	14
Definitions and Feature Explanations	7	Self Diagnostics Failure Code Explanation	14
How to Operate	8	Anti-Theft Installing Instructions	15
Manual Heating	8	Installation Instructions for Stacking	16
Programming Memory Pads	10	Sanitary Counter Top Seal	16
		Care of Your Microwave Oven	17
		Heating and Defrosting Time Charts	18

Owner's Record

Model No. NE-

Serial No. _____

The serial number of this product may be found on the side of the oven.

Dealer's Name _____

Dealer's Address _____

Date of Purchase _____

See page 14 before calling

Toll Free Service Information

To locate a convenient service agent call

1-800-545-2672

Chef Support: 201-348-7305

IMPORTANT SAFETY INSTRUCTIONS

When using electrical appliances, basic safety precautions should be followed, including the following:

WARNING—To reduce the risk of burns, electric shock, fire, injury to persons or exposure to excessive microwave energy:

1. Read all instructions before using this oven.
2. Read and follow the specific **“PRECAUTIONS TO AVOID POSSIBLE EXPOSURE TO EXCESSIVE MICROWAVE ENERGY”**, on the previous page.
3. This oven must be grounded. Connect it only to properly grounded electrical outlet. See **“GROUNDING INSTRUCTIONS”** found on page 4.
4. Install or locate this oven only in accordance with provided installation instructions.
5. Some items such as whole eggs or sealed containers—for example, closed glass jars—may explode and should not be heated in this oven.
6. Use this appliance only for its intended use as described in this manual. Do not use corrosive chemicals or vapors in this appliance. This type of oven is specifically designed to heat, cook, or dry food.
It is not designed for industrial or laboratory use.
7. **Do not leave children alone**—Children should not be left alone or unattended in an area where appliance is in use. They should never be allowed to sit or stand on any part of the appliance.
8. Do not operate this oven if it has a damaged cord or plug, if it is not working properly, or if it has been damaged or dropped.
9. This oven should be serviced only by qualified service personnel. Contact the nearest authorized service agent for examination, repair or adjustment.
10. Do not cover or block any openings on this oven.
11. Do not store or use this oven outdoors. Do not use this oven near water—for example, near a kitchen sink, in a wet basement, or near a swimming pool.
12. Do not immerse cord or plug in water.
13. Keep cord away from heated surfaces.
14. Do not let the cord hang over edge of the table or counter.
15. When cleaning the surfaces of the door and the oven that come together, use only a mild, non-abrasive soaps or detergents applied with a sponge or soft cloth.
16. To reduce the risk of fire in the oven cavity:
 - (a) Do not overcook food. Carefully attend the oven if paper, plastic, or other combustible materials are placed inside the oven to facilitate cooking.
 - (b) Remove wire twist-ties from paper or plastic bags before placing the bag in the oven.
 - (c) If materials inside the oven should ignite, keep oven door closed, turn the oven off, and disconnect the power cord, or shut off the power at the fuse or circuit breaker panel.
 - (d) Do not use the cavity for storage purposes. Do not leave paper products, cooking utensils, or food in the cavity when not in use.

SAVE THESE INSTRUCTIONS

For proper use of your oven read remaining safety cautions and operating instructions.

Grounding Instructions and Installation

Placement of the Oven

Locate the oven on a smooth, flat and stable surface. There should be no gap between the table surface and the bottom of the oven. Do not place the oven in a hot or damp area, ie. near a stove. Free airflow around the oven is important. There is a possibility of a small amount of interference with weak broadcast signals if the microwave oven is too close to a radio or TV.

Grounding Instructions

This oven must be grounded electrically. In the event of an electrical short circuit, grounding reduces the risk of electric shock by providing an escape wire for the electric current. This appliance is equipped with a cord having a grounding wire with a grounding plug. The plug must be plugged into an outlet that is properly installed and grounded.

WARNING—improper use of the grounding plug can result in a risk of electric shock.

Consult a qualified electrician or service person if the grounding instructions are not completely understood, or if doubt exists as to whether the appliance is properly connected.

If it is necessary to use an extension cord, use only a three wire extension cord that has a three blade grounding plug, and a three slot receptacle that will accept the plug on the appliance. The marked rating of the extension cord should be equal to or greater than the electrical rating of the oven.

Anti-Theft Device

This Microwave Oven is equipped with one mounting hole on the bottom of the unit. Use a $\frac{5}{16}$ inch bolt to anchor the unit to your shelf or counter.

See "Anti-Theft" Installing Instructions" on page 15 for specific mounting instructions.

Removal of Protective Film

A blue protective film is used to prevent scratching of the outer case during transportation. Peel the film from the exterior of the oven before installation or use.

Wiring Requirements

No other appliance should share the circuit with the microwave oven. If it does, the branch circuit fuse may overload and either cause the oven to heat slower than expected or blow the fuse.

A. For Models NE-1257A / NE-1258A

The oven must be on a SEPARATE, 20 amp, 60 Hz—120 V GROUNDED CIRCUIT.

NE-1257A / NE-1258A

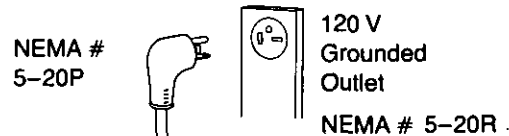

B. For Models NE-1757/NE-2157

1. This oven must be on a separate, 60 Hz GROUNDED CIRCUIT - minimum 15 amps for NE-1757; minimum 20 amps for NE-2157.
2. The microwave ovens are built to operate on 2 different voltages (230-240 V or 208 V). Be sure that the voltage selector connector (on the back of the oven) is set for your power supply. Using a higher voltage setting is dangerous and may result in overheating of the electrical components thus shortening their life expectancy or possibly causing a fire or other accident. Using a lower voltage will lower the power output of the oven, resulting in slower heating of the food. Panasonic is NOT responsible or damage resulting from the use of the oven with other than specified voltage.

NE-1757A

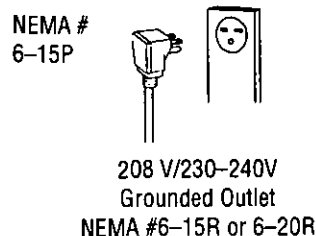

NE-2157A

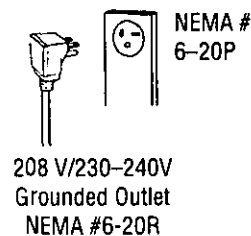

Caution

1. Do not attempt to tamper with or make any adjustments or repairs to the door, control panel housing, safety interlocks switch or any other part of the oven. Do NOT remove the outer panel of the oven. Repairs should only be done by a qualified service person.
2. Do NOT operate the oven empty. The microwave energy will reflect continuously throughout the oven if no food or water is present to absorb energy.
3. If a fire occurs in the oven, press the Stop/Reset pad and LEAVE THE DOOR CLOSED. Disconnect the power cord, or shut off the power at the fuse or circuit breaker panel.
4. Do NOT attempt to dry clothes, newspapers or other materials in the oven, as they may catch on fire.
5. Do NOT use recycled paper products, as they may contain impurities which may cause sparks and/or fires.
6. Do NOT use newspapers or paper bags for cooking.
7. Do NOT hit or strike the control panel. Damage to controls may occur.
8. POT HOLDERS may be needed when removing food from the oven. Heat is transferred from the hot food to the container.
9. Do NOT store flammable materials next to, on top of, or in the oven. It could be a fire hazard.
10. Do NOT operate the oven without the spatter shields (located in the top of inner cavity) in place.

Power Source Voltage Adjustment

The microwave oven Models NE-1757 and NE-2157 are factory set for 208 V operation. For 230 V–240 V operation, the following adjustment MUST be made.

- (Step 1)** Unscrew the voltage adjustment panel cover which is located on the back of the oven. Do not remove any other parts from the oven.
- (Step 2)** Remove the white connector and plug the black connector into the socket.
- (Step 3)** Store the unused white connector in the rectangular opening.
- (Step 4)** Reattach the voltage adjustment panel cover to the cabinet.

For 230 V–240 V—Use black connector plug.

For 208 V—Use white connector plug.

To go from 230 V–240 V to 208 V circuit follow steps 1–4 above, except at step 2, plug the white connector plug into the socket and store the black plug in the rectangular opening.

CAUTION

Make sure that the power cord is unplugged before removing the voltage adjustment panel cover.

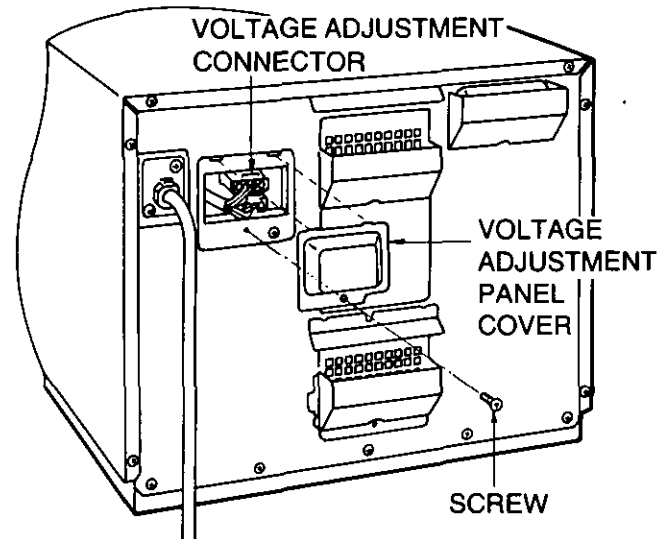

How Does The Microwave Work?

Microwaves are a form of high frequency radio waves similar to those used by a radio including AM, FM, and CB. They are, however, much shorter than radio waves; approximately five inches long. Electricity is converted into microwave energy by the magnetron tube. From the magnetron tube, microwave energy is transmitted to the oven cavity where it is: reflected, transmitted and absorbed.

Reflection

Microwaves are reflected by metal just as a ball is bounced off a wall. A combination of stationary (interior walls) and rotating antenna, located underneath the bottom shelf and above the ceiling cover assure that the microwaves are well distributed within the oven cavity to produce even heating or cooking of foods.

Transmission

Microwaves pass through some materials such as paper, glass and plastic much like sunlight shining through a window. Because these substances do not absorb or reflect the microwave energy, they are ideal materials for microwave oven heating containers.

Absorption

During heating, microwaves will be absorbed by food. They penetrate to a depth of about $\frac{3}{4}$ to $1\frac{1}{2}$ inches. Microwave energy excites the molecules in the food (especially water, fat and sugar molecules), and causes them to vibrate at a rate of 2,450,000,000 times per second. This vibration causes friction, and heat is produced just as you will feel heat produced if you vigorously rub your hands together. The internal heating of larger foods is done by conduction. The heat which is produced by friction is conducted to the center of the food. Foods also continue to heat by conduction during standing time.

Because microwaves dissipate, much like sunlight as it reaches the Earth's surface, they are not stored in food.

Radio Interference

1. Operation of the microwave oven may cause interference to your radio, TV or similar equipment.
2. When there is interference, it may be reduced or eliminated by taking the following measures:
 - a. Clean door and sealing surfaces of the oven. (See Care of Your Microwave Oven found on page 17.)
 - b. Place the radio, TV, etc. away from the microwave oven as far as possible.
 - c. Use a properly installed antenna, to obtain stronger signal reception.

Outline Diagram

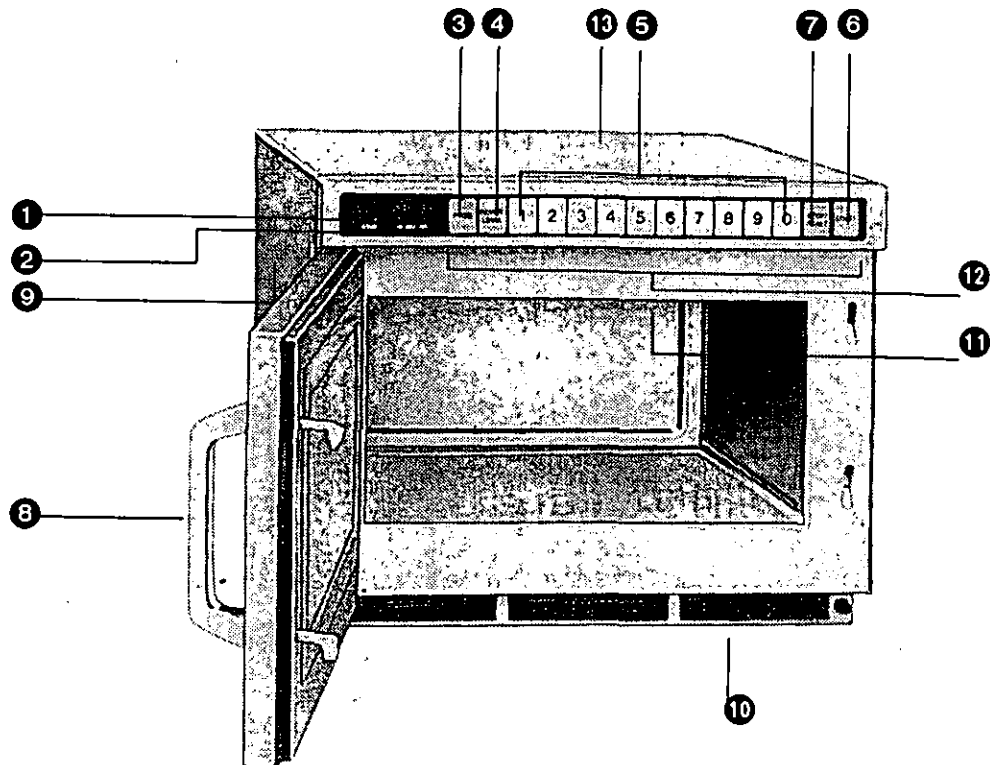

- | | |
|----------------------------------------------|-------------------------------------------------------------|
| ① Digital Display Window (see blow up below) | ⑧ Door Handle |
| ② Power Level Indicator Display | ⑨ Cavity Light Bulb Cover |
| ③ Program Pad | ⑩ Air Filter |
| ④ Power Level Selector Pad | ⑪ Splatter Shield
(top of inner cavity) |
| ⑤ Number/Memory Pads | ⑫ Control Panel |
| ⑥ Start Pad | ⑬ Voltage Adjustment Panel Cover
(rear side of the oven) |
| ⑦ Stop/Reset Pad | |

DIGITAL DISPLAY WINDOW

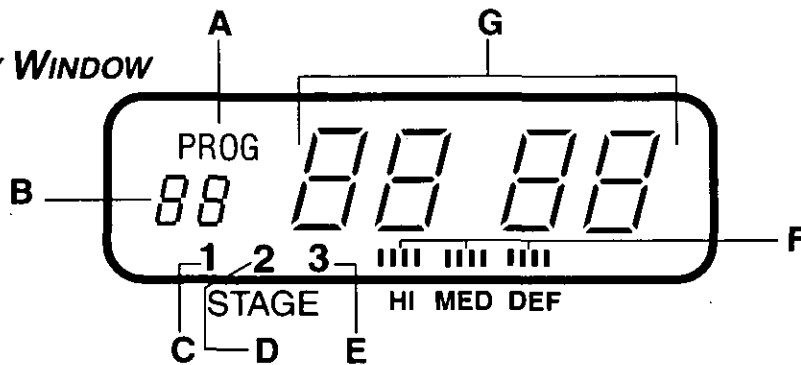

- | | |
|-------------------------------|-------------------------------|
| A—Program Display | E—3rd Stage Heating Indicator |
| B—Memory Pad Number Display | F—Power Level Indicator |
| C—1st Stage Heating Indicator | G—Time Display (min.sec.) |
| D—2nd Stage Heating Indicator | |

Definitions and Feature Explanations

This oven has many features not typically found on other commercial Microwave Ovens.

FEATURE	EXPLANATION
Manual Heating	Gives the user maximum flexibility to set the oven to desired heating time and power level. Ideal for menus that require variations in heating.
Single Stage Heating	Allows the oven to run at the selected power level for the selected heating time.
Two/Three Stage Heating	Allows the oven to be set to begin heating at one power level then shift automatically to a different power level after designated amount of heating time (ie. HI to MED or DEF to HI).
Interrupt Function	Allows opening the oven door to check on the food in the cavity. Closing the door and touching the Start Pad resumes heating. Cooking time does not erase while you check on your food. NOTE: Interrupt Feature is de-activated in "Program Lock."
Repeat Function (For Manual Heating Only)	After you remove your food from the oven the timer is automatically reset to repeat the last heating time and power level. This is especially convenient for Daily Specials that you do not want to program into a memory pad.
Two Step Operation (In "Program Unlock" Only)	Gives you time to confirm and or revise the selected heating program before starting the heat cycle. (Select heating program either manually or by Pad number then touch Start Pad.)
One Touch Start (In "Program Lock" Only)	One touch of the desired programmed number pads starts heating. Great for Fast Food, Convenience store and Vending applications.
Cycle Counter	The oven can display the total number of times the oven has been operated by pad number and by manual operation. Great for analyzing usage of the oven and traffic flow at the location.
Program Lock	<ol style="list-style-type: none"> 1. "Locks" the control panel number pads into their programmed heating times and power levels. 2. Converts the oven to "One Touch Start" operation. 3. Deactivates Program, Power Level Selector and Start Pads. 4. Deactivates Manual operation. Prevents unwanted erasing of Memory Pads. Simplifies operation—Great for chain restaurants; Convenience Store and Vending applications
Program Unlock	Deactivates "Program Lock" and activates all other features.
Self Diagnostics	The oven constantly monitors its operation. When an operational problem develops the Display window displays a Failure code. By checking the code number against the list in this manual you will know the nature of the problem and whether you can solve the problem yourself, need to call a service agent or need to call an electrician. If a service agent is required the Failure code number will let him know which parts to bring on the service call.
Tone Loudness Control	Allows setting of the loudness of the Beep Tone to one of 4 different levels.
Tone Length Control	Allows you to choose the length of the end of heating cycle beep tone to either 3 short beeps or 60 seconds of long beeps.
Program List	Allows you to review all currently programmed Pad number, heating time and Power level for each stage.

How to Operate

This oven is preset at the factory for the following:

For models

NE-1757/NE-2157

1. 208 Volts Power Source

For models NE-2157A / NE-1757A

NE-1257A / NE-1258A

1. Manual operation
2. Number Pads pre set to high power at the indicated heating times for single stage heating

1=10 sec.	6=1 min.
2=20 sec.	7=1 min. 15 sec.
3=30 sec.	8=1 min. 30 sec.
4=40 sec.	9=1 min. 45 sec.
5=50 sec.	0=2 min.
3. Program unlock
4. Cycle counter set to "0" on all pads.

If you desire any other feature please consult the owners manual to find how to activate the feature.

A. Manual Single Stage Heating



1. Make sure the oven is plugged into a properly grounded electrical outlet.



2. Open the door. The cavity light will come on. The cooling fan will start if the oven has been operating. "0" will appear in the display window.



3. Put the food into a suitable container, place it in the center of the oven and then close the door securely.
4. Select the desired power level by touching the Power Level Selector Pad. The Selected Power Level will be displayed in the display window and the single stage heating indicator, "1" will start to blink.

[Example]: Touch the Power Level Selector Pad 1 time for HIGH Power, 2 times for Medium and 3 times for Defrost.



5. Set the desired heating time by touching appropriate number pads in the combination of minutes and/or seconds desired, (up to 15 min. on HI or MED—or 30 min. on DEF).

[Example]: Touch 2, 0 and 0 for 2 minutes.

Note: When you set over the limited time and press START pad, the indicator the single stage heating indicator "1" and the time will blink. Please cancel by STOP/RESET pad and set correctly again.

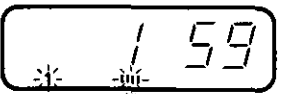

6. Touch the START Pad:
 - A. The cavity light will come on.
 - B. Heating will start.
 - C. The Power Level and the single heating indicators stage "1" will start to blink.
 - D. The time on digital display will count down.
7. When all time expires, the end of cycle Beep Tone will sound and all heating will stop. The cavity light will go off. The fan will continue to run until the oven has cooled off. The display will blink "0" until the door is opened.



8. Open the door and take the food out. The digital display will return to the originally selected time and power. The oven light will go off.



9. Close the door. One minute later, the fan will stop and the digital display will go blank.

SPECIAL NOTE: For both single and 2/3 stage heating:

1. While heating, one touch on the STOP/RESET pad stops the oven. You can restart it by touching the START pad or a second touch on the STOP/RESET pad will cancel the selected program.
2. While NOT in a heating cycle one tap on the STOP/RESET pad cancels the selected program.

REPEAT FEATURE

1. You can repeat exactly the same manually selected heating time by touching only the START pad, if you use the oven again within 1 minute (within 30 minutes when the door has been left open).
2. After 1 minute of non-use with door closed (30 minutes with the door open), the repeat feature will be cancelled.

B. Manual 2 / 3 Stage Heating

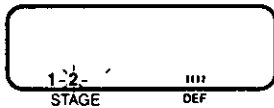

1. Follow Steps 1 to 5 on page 8.
2. Select the desired Power Level for the next stage heating by touching Power Level Selector Pad the appropriate number of times to select the desired power level (see page 8, #4). The selected Power Level will be displayed in the Display Window and the next stage indicator will start to blink ("2" for the second stage and "3" for the third stage). (Example: Touch the Power Level Selector Pad 3 times for Defrost.)

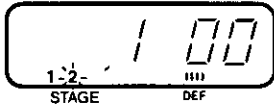

3. Set the desired heating time for the next stage by touching the appropriate number pads. (Example: for 1 minute, touch pads 1, 0, & 0.)

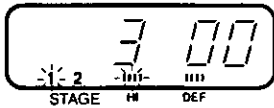

4. For a third stage, repeat steps 2 & 3 above. (Maximum is (3) three stages of heating.)
5. Touch the START pad (this indicates the COMPLETION of programming).

- A. The total time for all stages will be displayed.
- B. The cavity light will come on.
- C. The single stage indicator "1" will start to blink while the second stage indicator "2" / "3" will stay on. The Power Level indicator for the first stage will start to blink.
- D. The time on digital display will count down.

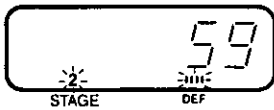

6. After the first stage heating time expires, a single beep tone will sound. The Power Level indicator for the second stage will start to blink and the time on the digital display will continue to count down. After the second stage heating time expires, a single beep tone will sound. (The Power Level indicator for the third stage will start to blink and the time on the digital display will continue to count down.)

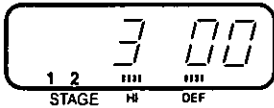

7. When all time expires, the end of cycle Beep Tone will sound. All heating will stop. The cavity light will go off. The time display will blink "0" until the door is opened.

8. Open the door and take the food out. The digital display will return to the originally selected time and power. The oven light will come on and the cooling fan will continue.

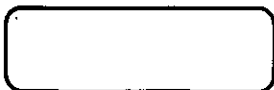

9. Close the door. Cavity light will go off and the fan will continue to run until the oven has cooled off. One minute later, the Display Window will go blank.

See Special Note of "Manual Single Stage Heating" — Above.

C. Programming Memory Pads for Single Stage Heating

The oven can not be programmed until the program lock feature is deactivated. Oven is locked if operation starts by touching programmed pad without having to touch START pad.

(See page 12, G. To Activate Program Lock.)

1. Make sure the oven is plugged into a properly grounded electrical outlet.

—DO NOT OPEN THE DOOR—

The display window MUST be blank before programming can begin.

If any indicator light is illuminated in the digital Display Window:

- A. Close the door, touch STOP/RESET pad and wait 1 minute until the Display goes blank.
- B. Read cycle counter for any pad then quickly close the door if you desire to make the display blank more quickly (see page 11, F).

2. Touch PROG pad. "PROG" sign will start to blink in the Display Window.

Do not keep pressing PROG pad for more than 5 seconds, or a false failure code may result.

3. Touch Memory Pad you desire to reprogram. The pad number and the previously selected time and Power Level will appear in the Display. "PROG" and the single stage heating indicator "1" will blink.

[Example]: Touch Memory Pad Number 4.

4. Select the desired Power Level by touching the Power Level Selector Pad. —the selected Power Level will be displayed in the window and the heating time display will go blank.

[Example]: Touch the Power Level Selector Pad 3 times for DEFROST.

5. Set the desired heating time by touching the appropriate number pad in combination of minutes and seconds desired. (Up to 15 min. on HI and MED—or 30 min. on DEF.)

[Example]: For 1 minute touch pads 1, 0 and 0.

6. Touch the PROG pad again. The "PROG" sign will stop blinking. This means that you have completed reprogramming the selected Memory Pad for single stage heating.

7. Three seconds after programming is completed the display will go blank.

8. Program the remaining Memory Pads as desired by repeating Step 2–7 above.

DO NOT OPEN THE OVEN DOOR WHILE PROGRAMMING.

Note: When the "PROG" Display is blinking the program can be cancelled and/or the pad erased by touching the STOP/RESET pad.

D. Programming Memory Pads for 2 / 3 Stage Heating

1. Complete steps 1 to 5 above. DO NOT TOUCH THE "PROG" PAD.

2. Select the Power Level by touching the Power Level Selector Pad for the 2nd stage of heating. The selected Power Level and the second stage indicator "2" will be displayed in the Display Window. "PROG" and "2" will both blink. (Example: Touch the Power Level Selector Pad 1 time for HIGH power.)

3. Set the desired heating time by touching the appropriate number pads. (Up to 15 min. on HIGH & MED - or 30 min. on DEF.) (Example: for 2 minutes, touch pads 2,0 and 0.) Programming for second stage heating is now complete.

4. Select the power level by touching the Power Level Selector Pad for 3rd stage of heating. The selected Power Level and the third stage "3" will be displayed in the Display Window. "PROG" and "3" will both blink. (Example: Touch the Power Level Selector Pad 2 times for MED power.)

5. Set the desired heating time by touching the appropriate number pads.

6. Touch the PROG pad again and the "PROG" sign will stop blinking and the STAGE Indicators (1,2 and 3) will remain illuminated. The total time for all stages will be displayed. This means that you have completed programming the desired Memory Pad for 2/3 heating.

7. Three seconds after programming is completed, the Display Window will go blank.

8. Program the remaining pads as desired by repeating the steps above.

DO NOT OPEN THE OVEN DOOR during programming.

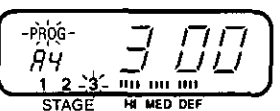
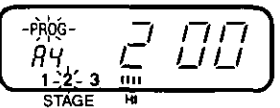
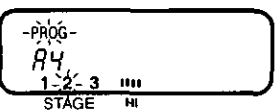
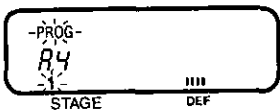
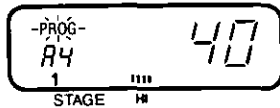

E. Memory Pad Heating for Single and Multi-Stage Heating

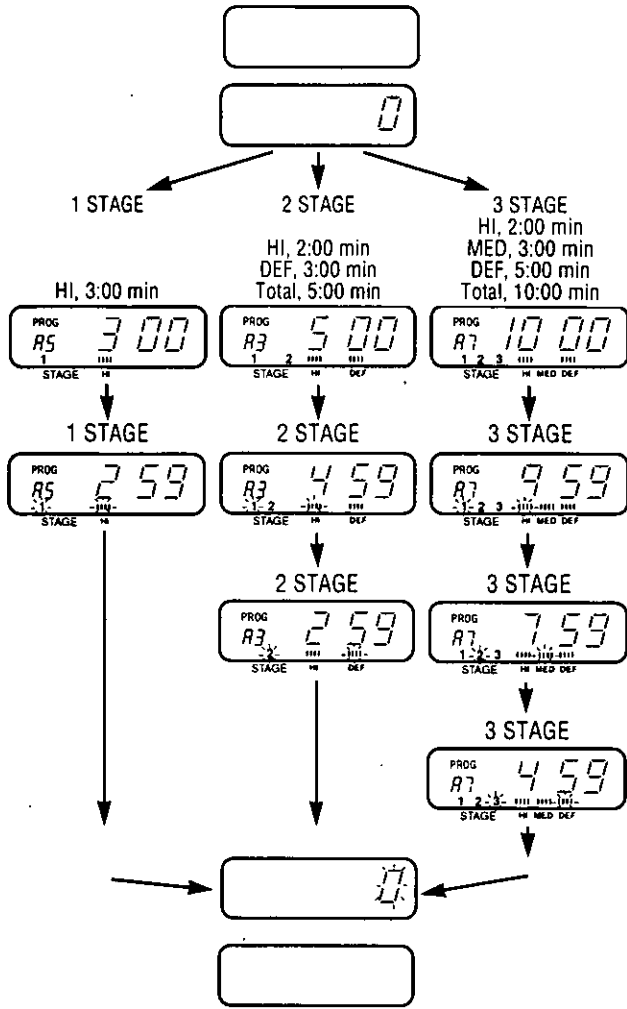

- Make sure the unit is properly programmed (see page 10).**
1. Make sure the unit is plugged into a properly grounded electrical outlet.
 2. Open the door. The cavity light will come on. The cooling fan will start if the oven has been operating. "0" will appear in the display window.
 3. Put the food into a suitable covered container and place it in the center of the oven. Close the door.
 4. Touch the desired Memory Pad.
 - **1 Stage Heating:** "PROG", Pad number, heating time, power level and "1" will be displayed.
 - **2 Stage Heating:** "PROG", Pad number, total heating time for both stages, "1" and "2" and power levels will be displayed.
 - **3 Stage Heating:** "PROG", Pad number, total heating time for all stages. "1", "2", "3", and power levels will be displayed.
Example: Memory Pad 5 (A5) - 1 stage heating
Memory Pad 3 (A3) - 2 stage heating
Memory Pad 7 (A7) - 3 stage heating
 5. Touch START Pad.
 - **1 Stage Heating:** "1" and Power Level indicators blink while heating time counts down.
 - **2 Stage Heating:** First stage indicator "1" and the first stage Power Level blink while the heating time counts down. At the end of the first stage heating time, one beep tone will sound and the oven will shift to the second stage heating. Count down continues, but now the "2" and second Power Level blink.
 - **3 Stage Heating:** First stage indicator "1" and the first stage Power Level blink while the heating time counts down. At the end of the first stage heating time, one beep tone will sound and the oven will shift to the second stage heating. Count down continues, but now the "2" and second Power Level blink. At the end of the second stage heating time, one beep tone will sound and the oven will shift to the third stage heating. Count down continues, now the "3" and third Power Level blink.
 6. When all time expires, the end of the cycle Beep Tone will sound. All heating will stop. The cavity light and the fan will go off. The time display will blink "0" until the door is opened.
 7. Open the door and remove the food. Close the door. One minute later, the display window will go blank and the fan will stop.

F. To read the Cycle Counter



1. Make sure the unit is plugged into a properly grounded electrical outlet.



2. Open the door and leave it open. The cavity light will come on. The cooling fan will start if the oven has been operating. "0" will appear in the display.

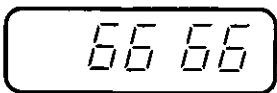

3. While touching the STOP/RESET Pad press each Memory Pad. The display shows the number of times each Memory Pad has been used. Within 3 seconds, touch the Power Level Selector Pad to show the number of times the oven has been used in the manual mode. *Example: 6666 is 6,666 uses.*

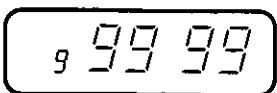

4. Remove your finger from STOP/RESET Pad and quickly close door while the display is still showing a Pad's cycle count. The display will now show the total cumulative number of times the oven has been used. *Example: 99999 is 99,999 uses.*
Three seconds later, the Display Window will go blank.

NOTE: Total cumulative number includes programmed memory heating and manual heating number of times oven has been used.



5. Individual pads will count cycles up to 9999, and then reset to zero. Total cycle count will count cycles to 99,999, and then reset to zero. Cycle count can be reset to zero manually.

G. To Activate Program Lock

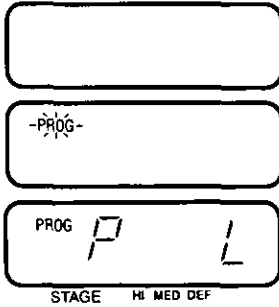

1. Make sure the unit is plugged into a properly grounded electrical outlet.
2. DO NOT OPEN THE DOOR. The Display Window must be blank before the Program Lock feature can be activated.
3. Press and hold in the PROG pad until the display show "PROG", "P" and "L" (for 5 seconds).
4. Program Lock feature is now activated.
5. Do not press PAD for longer than 10 seconds continuously, or a false failure code may result.

Note: In "Program Lock"

- a. The oven is started by touching the desired memory pad. There is no need to touch the start pad.
- b. The Interrupt feature is de-activated—opening the door cancels the remaining time on the program.
- c. The oven can not be programmed or run manually until the program lock feature is de-activated.

H. To Release Program Lock

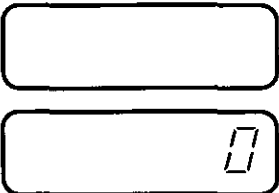

1. Make sure the unit is plugged into a properly grounded electrical outlet.
2. Open the door. The cavity light will come on. The cooling fan will start if the oven has been operating. "0" will appear in the display. First, press the STOP/RESET pad and while pressing this pad, touch the PROG pad.

Hold in for five (5) seconds, until the display window shows "PROG" and "P".

Note: Unless the beep sound has been deactivated, the oven should beep once when both pads are pressed at the same time. Do not press pads continuously for more than ten (10) seconds, or a false failure code may result.



3. Program Lock feature is deactivated, oven is now in "Program Unlock" mode.

Note: In "Program Unlock"

- a. Oven reverts to a 2 touch operating mode (Number Pad plus Start Pad).
- b. Repeat and interrupt features are operational.
- c. Memory Pads can be programmed.
- d. Manual Heating is operational.
- e. Tone loudness control and length control are operational.

I. To Read Program List

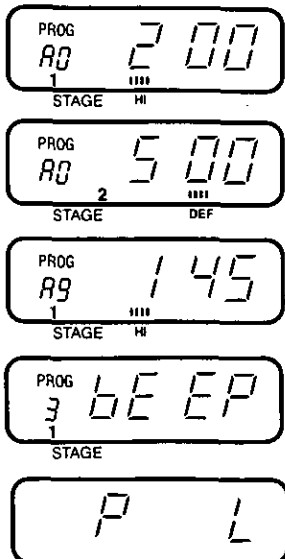

1. With the door opened, while touching the STOP/RESET pad, press and hold in the START pad for 3 seconds.
2. Display window will display: Pad 1. heating time and Power Level currently programmed on Pad 1., first stage heating. Two seconds later the same information will be displayed for the second heating stage.
3. Display will continue to sequence through the pad numbers.
4. After all memory pad settings have been displayed, the display then shows the beep tone settings followed by the Program Lock: "P", "L" (or Program Unlock: "P") and Air Filter program period.
5. "0" will appear in the display window. Close the door. After one (1) minute, the Display Window will go blank.

J. To Select Beep Tone Options

The Beep Tone can be set for Loudness—(4 Levels) and Length of Tone—(2 Options). You can select the combination of Loudness and Length that best suits your needs. The Beep Tone is set at the factory for the loudest level (#3) and for 3 Beeps.

To Select Loudness Level



1. Make sure the unit is plugged into a properly grounded electrical outlet.
2. Open the door and leave it open. The cavity light will come on. The cooling fan will start if the oven has been operating. "0" will appear in the display.
3. Touch PROG pad first and then within 1 minute press "0" pad. "3 bEEP" and first stage heating indicator "1" will appear in the display window and "PROG" will blink.
4. Select the desired sound loudness level by touching "0" pad. Repeated touching of "0" pad will lower the loudness of the tone all the way to silent. The Tone will sound at its loudness level and the display window will display loudness level in digits (3 to 0—loud to silent) followed by the word "bEEP".
[Example]: 3 bEEP—Loud
2 bEEP—Medium
1 bEEP—Soft
0 bEEP—Silent
5. Touch the PROG pad again, "PROG" will stop blinking. You have completed selecting the loudness level.
6. Close the door. One minute later display window will go blank and the cooling fan will stop.



To Select Length of Tone

At end of heating cycle there are 2 options.

- A. 3 Beeps (Factory Setting)
- B. 60 seconds of Short Beeps

To Program for 60 Seconds of Short Beeps

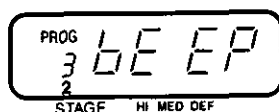

1. Complete steps 1–4 above (Select loudness level).
DO NOT CLOSE THE DOOR
2. Touch PROG pad and quickly select the desired tone length by touching "0" pad.
 - A. "PROG" will blink.
 - B. Current loudness level will be displayed.
 - C. Second Stage Heating Indicator will illuminate.
[Example]: First Stage Indicator "1" Illuminated=3 BEEPS
Second Stage Indicator "2" Illuminated=60 Seconds of BEEPS
3. When the desired length of tone has been selected (1, or 2), press the PROG pad again.
 - A. "PROG" will illuminate.
 - B. 3 seconds later, the display window will show "0".
4. Close the Door. One minute later display window will go blank and the cooling fan will stop.

J. Procedure to Program the Air Filter



1. Open the door and leave it open.



2. While pressing START pad, close and open the door.

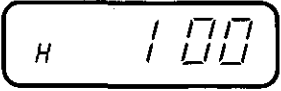

3. Quickly press "3" pad once. The display will show the length of time original PRESET.
Example: 100 hours



4. Set the desired heating time by pressing appropriate pads.
Example: 1230 hours; press 1 2 3 0

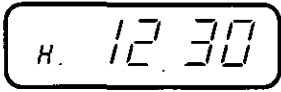

5. Press **PROG** pad.



6. After 3 seconds, "0" will appear.



7. After programmed time passes at the end of cooking, "FIL7" will appear in the Display Window.

8. To reset, clean filter & follow steps 1-7 above.

NOTE: The time to next reset is determined by condition of filter.

NOTE: To check the totally number of hours used; open the door and leave it open. While pressing the **START** pad, press the **3** pad. The display will show the number of hours used. "**PROG**" and "**H**" will appear in the Display Window.

Example: If the oven has been used for 20 hours:

After 3 seconds, "0" will appear in the Display Window.



SELF DIAGNOSTICS FAILURE CODE EXPLANATION

This oven monitors its operation and displays a Failure Code in the display window when a problem occurs.

FAILURE CODE	PROBLEM	WHAT TO DO (BELOW)
F01	Temperature of exhaust air too High	1./2./3./4./5.
F03	Incoming Line Voltage too High	6./7./8.
F04	Incoming Line Voltage too Low	6./5./8.
F11	Defective Upper Magnetron Circuit	1./7./9.
F12	Defective Lower Magnetron Circuit	1./7./9.
F21	Defective Upper Magnetron Circuit	1./7./9.
F22	Defective Lower Magnetron Circuit	1./7./9.
F33	Open Thermistor	1./7./9.
F34	Short in Thermistor	1./7./9.
F44	Defective Control Panel	1./7./9.
F51	Defective Upper Relay	1./7./9.
F52	Defective Bottom Relay	1./7./9.

- Oven shuts off automatically. Disconnect the power cord from the wall receptacle.
- Oven beeps continuously.
- Oven resets for operation when cool.
- Move oven to cooler location.
- If problem persists, call service agent.
- Change voltage adjustment plug on rear of oven (see page 5).
- Give service agent the diagnostic code number so he can bring the needed parts.
- Have an electrician check the voltage at the electrical outlet.
- Disconnect the power cord from the wall receptacle, wait one minute and reconnect. If normal operations does not resume, call service agent.

Notes

Installation Instructions for Stacking

Important

1. Disconnect the power cord from the wall receptacle before attempting installation.
2. For stacking installation, you must use the PANASONIC "Joint Plate" which is enclosed with this unit.
3. Combination of the unit for stacking is limited within only the following PANASONIC models.

NE-1257, NE-1258, NE-1757, NE-1767

4. The maximum stacking height is two units.

Preparation

Be sure the oven cavity is empty.

Installation

1. Stack the units and remove the screws from individual unit as shown in Fig. 1.
2. Two projections on the joint plate must face away from the oven.
3. Attach PANASONIC Joint Plate to top of the base unit first by using the on the base 3 screws previously removed. See Fig. 2.
4. Carefully place the top unit on the base so as to align the five screw holes of the top unit with those of the Joint Plate. Then attach and tighten the five screws. See Fig. 3.

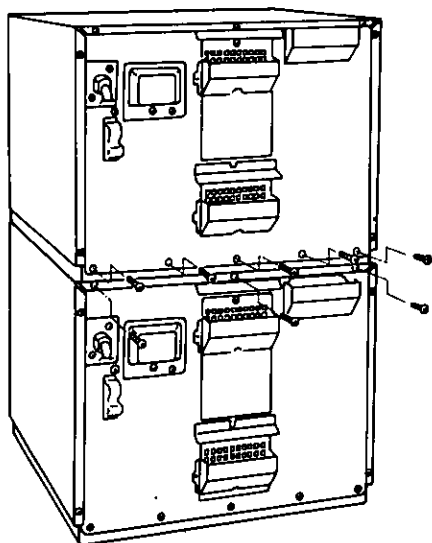

Fig. 1.

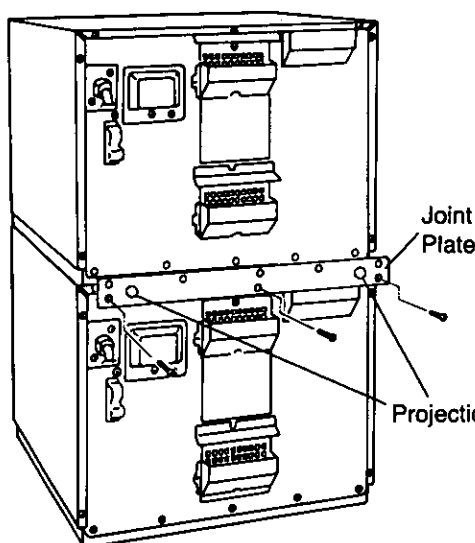

Fig. 2.

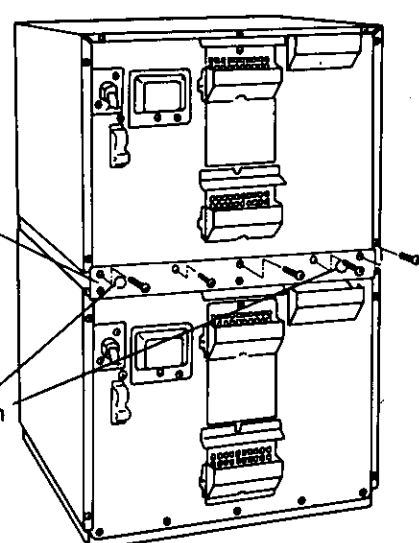

Fig. 3.

Sanitary Counter Top Seal

When this microwave oven units are stacked on a counter top, their base must be sealed in accordance with N.S.F. Standards as per the following instructions.

1. Microwave oven should be located on a level counter top surface. Complete the electrical, connections.
2. Thoroughly clean the microwave oven bottom perimeter and the counter top area around the microwave oven perimeter.
3. Lay a generous bead of silicone seal around the entire perimeter of the two microwave oven bottoms.
4. Smooth the silicone seal into the crevice with finger or tool to provide a cove seal.

Note: Remove the air filter from the front of the oven before applying silicons. DO NOT FORGET to re-install the Air Filter after applying silicon.

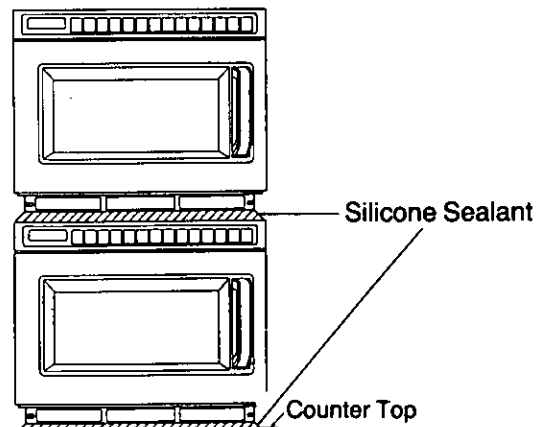

Care of Your Microwave Oven

1. Remove the plug from the electrical socket before cleaning.
2. Keep the inside of the oven clean. If pieces of food or spilled liquids stick to the oven walls, or between door seal and door surface, they will absorb microwaves and may cause arcing or sparks. Wipe up all spills with a damp cloth. Kitchen detergent may be used if the oven gets very dirty. Do not use harsh detergents or abrasives.
3. The outside surface of this Microwave Oven should be cleaned with soap and water, then dried with a soft cloth. Make sure that water does not get into the back ventilation opening since this can damage the unit.
4. The window of the door should be washed with very mild soap and water. Be sure to use a soft cloth. Never use window cleaner. The front door can be scratched by harsh soap or cleaners.

Cleaning of the Splatter Shield

1. Hold snap in-snap out side stoppers of splatter shield with both hands and pull them in and down. Then take the splatter shield out of the oven cavity.
2. Rinse splatter shield in the soapy water.
3. Be sure to replace the shield before using the oven.

CAUTION

Splatter Shield must be in place securely when you use the oven.

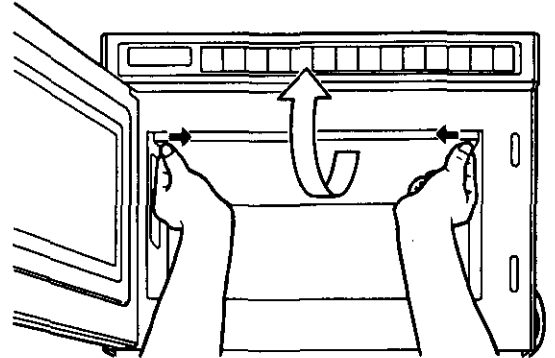

Cleaning the Air Filter

Clean the Air Filter occasionally according to the following instructions. Problems may occur with the oven if the filter become clogged with dirt or dust.*

1. Remove the Air Filter from the front bottom skirt by pulling the Pop Pin straight out. Then slide the filter to the right and lift it off the post.
2. Wash the filter with soap and water.
3. To replace, align the filter with the post, and holding the front of the Pop Pin forward, insert the back of the pin into its hole. Press the front of the pin and it will pop into place. Be sure to replace the air filter before using this oven.

*If the Air Filter becomes clogged with dust or grease this will cause an overheating problem in the oven.

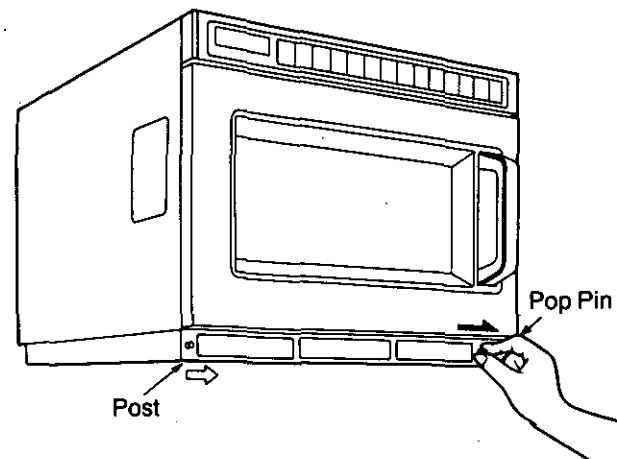

Replacement of the Cavity Light Bulb

If the Cavity Light burns out, you can replace it yourself by following these simple directions.

1. Unscrew the Cavity Light Cover which is located on the left side of the cabinet.
2. Replace the old bulb with a new bulb.
3. Close the Cavity Light Cover.

(use 120 V-125 V 20 W for NE-1257A / NE-1258A)
(use 230 V-250 V 20 W for NE-1757A
(use 230 V-250 V 20 W for NE-2157A

CAUTION

Remove the plug from the electrical socket before replacement of the Cavity Light Bulb.

Heating and Defrosting Time Charts

Table of Contents

Microwave Basics	19
General Guidelines for Heating in Panasonic Microwave Oven	19
Appetizers	20
Baked Goods and Desserts	21
Breakfast	22
Fish and Seafood	24
Gravies, Sauces, and Soups	25
Plated Meat and Poultry Entrees	26
Rice and Pasta	27
Sandwiches	28
Vegetables	29
Casseroles	31
Technical Specifications	32

Note: All heating times in the following charts are "approximate". We recommend you test your own recipe items and plating techniques in this oven to establish the correct heating times for your recipe items.

Maximum programmable time for each stage heating is

HI and MED power 15 min.

DEF power 30 min.

Example: For items that cook longer than 15 minutes on MEDIUM power, please program oven for two or three stage cooking.

For example: To program 35 minutes on MEDIUM.

1st stage: Program on MEDIUM 15 minutes.

2nd stage: Program on MEDIUM 15 minutes

3rd stage: Program on MEDIUM 5 minutes

TOTAL TIME on MEDIUM is 35 minutes

Microwave Basics

Fundamental principles determine the success of microwave food preparation. They include:

- 1. Temperature of Foods**—Frozen or refrigerated food items will require longer heating times to reach a desired serving temperature than foods from room temperature.
- 2. Food Components**—Foods high in sugar, salt, fats and moisture content heat faster because these properties attract microwave energy. Denser foods high in protein and fiber, absorb microwave energy slower which means a lengthier heating time.
- 3. Bulk/Volume**—The greater the mass of food, the longer it takes to heat.
- 4. Containers**—Ceramic, paper, china, styrofoam, glass and plastic are suitable for use in microwave ovens with the following caution:

Heating foods with either high sugar or high fat content should be done **ONLY** in high temperature-resistant containers since these foods get very hot. Using styrofoam containers for these foods will cause the styrofoam to warp. Other low temperature restaurant glass or plastic platters may crack or warp under similar conditions.

DO NOT HEAT foods in a **SEALED** container or bag. Foods expand when heated and can break the container or bag.

- 5. AVOID METAL** because it “bounces” the microwaves, causing uneven heating and sometimes even flashes, which may pit or mar the interior of the oven, the metal container or plate trim.
- 6.** Heated liquids can erupt if not mixed with air. Do not heat liquids in your microwave oven without first stirring.

General Guidelines for Heating in a Panasonic Microwave Oven

For specific time, see each food category for appropriate heating techniques, plus necessary pre-preparation of foods.

Heating Foods From Refrigerated Temperature

Foods stored in the refrigerator (40°F) should be covered before reheating with the exception of breads, pastries or any breaded product, which should be heated uncovered to prevent sogginess.

Most conventionally prepared foods should be slightly undercooked, and held in the refrigerator, so that overcooking does not occur during microwave heating.

Cooked items, such as vegetables, may be portion plated and covered for reheating without loss of color, texture or nutritional content.

Heating Foods From Room Temperature

Food items such as canned entrees, vegetables, etc. will require significantly less heating time than those from refrigerated temperatures.

Important Recommendations

- For best results it is recommended that foods conventionally prepared be slightly undercooked when subsequently heated in this oven.
- REMEMBER** that after the heating cycle has been completed, internal food temperatures continue to rise slightly in foods heated in this oven.
- A major abuse of microwave applications is the category of breads and baked goods. Because crusts of breads, pastries and pies are drier than insides or fillings, they heat more slowly. Therefore, baked goods should **ONLY** be heated until the crust is warm to the touch (120°F–130°F).
- DO NOT OVERHEAT YOUR FOOD: 99% of all food quality complaints of microwave heated foods can be traced to overheating.**

Appetizers

Quantities of appetizers can be prepared conventionally in advance and refrigerated until needed. Most appetizers, with the exception of "nacho" platters and potato skins, should be heated covered. Appetizers of the same basic shape and size can be reheated together.

Most cooked appetizers heat on HIGH power, between 7 and 11 seconds per ounce depending on weight, density, and bone content. "Nacho's" need 30 to 37 seconds per ounce depending on the amount of topping.

All heating times listed in the chart are from refrigerated temperatures (40°F) except for "nacho" chips.

Item	Quantity	Instructions for Pre-preparation	Instructions for Microwave Heating	Power Setting	Approximate Times		
					NE-1257 NE-1258	NE-1757	NE-2157
BBQ Ribs	224 g (8 oz.)	Prepare conventionally, refrigerate, covered.	Place on plate, cover.	HIGH	60 sec.	45 sec.	35 sec.
Chicken Wings	140-168 g (5-6 oz.)	Prepare conventionally, refrigerate, covered.	Place on plate, cover.	HIGH	50 sec.	35 sec.	25 sec.
Chili con Queso	224 g (8 oz.)	prepare conventionally, refrigerate, covered.	Place in small bowl, cover.	HIGH	1:15 min.	50 sec.	40 sec.
Meatballs	112-140 g (4-5 oz.)	Prepare conventionally, refrigerate, covered.	Place on plate, cover.	HIGH	50 sec.	35 sec.	25 sec.
Nachos	112 g (4 oz.)	For Best Results— Prepare when ordered or only a short time before serving to keep chips crisp.	Spread refried beans on each individual nacho. Arrange on platter. Sprinkle with Cheddar cheese. DO NOT COVER.	HIGH	50 sec.	35 sec.	25 sec.
Potato Skins	224 g (8 oz.)	Prepare skins conventionally, refrigerate, covered.	Arrange skins on platter. Sprinkle with shredded Cheddar cheese and cooked, crumbled bacon. DO NOT COVER.	HIGH	60 sec.	45 sec.	35 sec.
Rumaki	112 g (4 oz.)	Prepare conventionally, refrigerate, covered.	Place on plate, cover.	HIGH	35 sec.	25 sec.	20 sec.
Shrimp de Jonghe	112 g (4 oz.)	Prepare conventionally, refrigerate, covered.	Place on small plate, cover.	HIGH	55 sec.	40 sec.	30 sec.

Baked Goods and Desserts

Breads, pastries and pies should be heated uncovered, at HIGH power. They should be placed on absorbent material, such as a napkin or paper towel to prevent sogginess.

DO NOT OVERHEAT breads and pastries. Baked goods should only be heated until the crust feels warm to the touch (120°F–130°F).

Because crusts of breads, pastries, and pies are drier than insides or fillings, they heat more slowly. After heating let rest about 1 minute for equalization of temperature. If product is overheated, the end result will not be satisfactory.

Heating times for sweet baked goods and desserts are relatively short because of the high sugar content.

Item	Quantity	Instructions for Pre-preparation	Instructions for Microwave Heating	Power Setting	Approximate Times		
					NE-1257 NE-1258	NE-1757	NE-2157
Bread, mini-loaf white or wheat	224 g (8 oz.)	Prepare conventionally, store at room temperature.	Place on paper towel, uncovered	HIGH	25 sec.	15 sec.	10 sec.
Coffee cake, frozen	84 g (3 oz.)		Place on paper towel, uncovered.	HIGH	20 sec.	13 sec.	07 sec.
Muffins, fruit	2 ea.	Prepare conventionally or defrost, store at room temperature.	Place on paper towel or napkin, uncovered.	HIGH	20 sec.	13 sec.	07 sec.
	6 ea.	Prepare conventionally or defrost, store at room temperature.	Place on paper towel or napkin, uncovered.	HIGH	30 sec.	20 sec.	15 sec.
Pie, fruit	1 slice 140 g (5 oz.)	Prepare conventionally, refrigerate, covered	Place on plate, uncovered.	HIGH	25 sec.	15 sec.	10 sec.
Rolls, hard	4 ea.	Room temperature.	Place on paper towel, uncovered, After heating, let rest 1 minute.	HIGH	25 sec.	15 sec.	10 sec.
Rolls, soft	6 ea.	Room temperature.	Place on paper towel, uncovered. After heating, let rest 1 minute.	HIGH	25 sec.	15 sec.	10 sec.
Rolls, sweet	6 ea.	Room temperature.	Place on paper towel, uncovered. After heating, let rest 1 minute.	HIGH	25 sec.	15 sec.	10 sec.

Breakfast

All foods listed are prepared in advance and reheated at HIGH power from refrigerated temperatures (40°F).

Most breakfast foods are heated covered to retain moisture, with the exception of breads and pastries, which should be heated uncovered on absorbent material such as a napkin or paper towel to prevent sogginess.

For poached eggs, pierce yolks before heating and allow eggs to stand for one minute after cooking so pressure subsides before cutting into them.

When preparing breakfast foods conventionally, undercook slightly and immediately chill and store, covered, for later reheating.

Cured breakfast meats will reheat faster than uncured meats because salt readily absorbs microwave energy.

WARNING: Never cook or reheat eggs in the shell. They may explode when interior pressure builds up.

Item	Quantity	Instructions for Pre-preparation	Instructions for Microwave Heating	Power Setting	Approximate Times		
					NE-1257 NE-1258	NE-1757	NE-2157
Bacon	4 strips	Prepare conventionally, undercook slightly, refrigerate, covered.	Place on plate and cover.	HIGH	30 sec.	20 sec.	15 sec.
Bacon, Canadian	4 slices	Prepare conventionally, refrigerate, covered.	Place on plate and cover.	HIGH	30 sec.	20 sec.	15 sec.
Eggs, poached	2 eggs	Prepare conventionally, undercook slightly, refrigerate in salted water, covered.	Remove from water. Place on plate, pierce yolks, cover. Let rest 1 minute after heating.	HIGH	30 sec.	20 sec.	15 sec.
Eggs, scrambled	2 eggs	Prepare conventionally, undercook slightly, refrigerate, covered.	Place on plate and cover.	HIGH	30 sec.	20 sec.	15 sec.
Eggs, scrambled with bacon	2 eggs 4 strips	Prepare conventionally, undercook slightly, refrigerate, covered.	Place on plate and cover.	HIGH	35 sec.	25 sec.	20 sec.
Eggs, scrambled with sausage links	2 eggs 4 links	Prepare conventionally, undercook slightly, refrigerate, covered.	Place on plate and cover.	HIGH	45 sec.	30 sec.	20 sec.
French toast	3 slices	Prepare conventionally, refrigerate, covered.	Plate toast on plate. Heat uncovered.	HIGH	35 sec.	20 sec.	15 sec.

Item	Quantity	Instructions for Pre-preparation	Instructions for Microwave Heating	Power Setting	Approximate Times		
					NE-1257 NE-1258	NE-1757	NE-2157
French toast with bacon	2 slices 4 strips	Prepare conventionally, refrigerate, covered.	Place toast on plate in single layer. Cover.	HIGH	45 sec.	35 sec.	30 sec.
French toast with sausage	2 slices 4 links	Prepare conventionally, refrigerate, covered.	Place toast on plate in single layer. Cover.	HIGH	45 sec.	35 sec.	30 sec.
Ham steak	112 g (4 oz.)	Prepare conventionally, refrigerate, covered.	Place on plate and cover. Let rest 1 minute after heating.	HIGH	40 sec.	30 sec.	25 sec.
Hash, corned beef, canned	84 g (3 oz.)	Prepare conventionally, refrigerate, covered.	Place on plate and cover.	HIGH	40 sec.	30 sec.	25 sec.
Pancakes	4 ea.	Prepare conventionally, refrigerate, covered.	Place on plate in single layer. Heat uncovered.	HIGH	35 sec.	20 sec.	15 sec.
Pancakes with bacon	4 ea. 4 strips	Prepare conventionally, refrigerate, covered.	Place on plate in single layer, cover.	HIGH	45 sec.	35 sec.	30 sec.
Pancakes and sausage patty	4 ea. 112 g (4 oz.)	Prepare conventionally, refrigerate, covered.	Place on plate in single layer, cover.	HIGH	45 sec.	35 sec.	30 sec.
Potatoes, hashed brown	126 g (4 1/2 oz.)	Prepare conventionally, refrigerate, covered.	Place on plate and heat uncovered.	HIGH	40 sec.	30 sec.	25 sec.
Sausage links	4 links	Prepare conventionally, undercook slightly, refrigerate, covered.	Place on plate, cover.	HIGH	40 sec.	30 sec.	25 sec.
Sausage patties	4 patties	Prepare conventionally, undercook slightly, refrigerate, covered.	Place on plate, cover.	HIGH	35 sec.	25 sec.	20 sec.

Fish and Seafood

Defrost

Fish and seafood can be defrosted and heated successfully in this microwave oven. To defrost evenly, fish should be arranged in a single layer in container and should only be thawed to the point of being flexible so it does not begin to cook at the edges.

Primary Cooking

Cooking individual portions demands close attention as well as slight undercooking. Delicate fish and shellfish should always be undercooked and should from rest after heating.

Fish/Seafood—Primary Cooking

Item	Quantity	Instructions for Pre-preparation	Instructions for Microwave Heating	Power Setting	Approximate Times		
					NE-1257 NE-1258	NE-1757	NE-2157
Lobster Tail	224 g (8 oz.)	Defrost. Refrigerate, covered.	Place on plate, brush with butter and cover.	HIGH	3 min. 30 sec.	2 min. 30 sec.	1 min. 30 sec.
Perch fillets	196 g (7 oz.)	Defrost. Refrigerate, covered.	Place in microwave pan and brush with butter and herbs.	HIGH	1 min. 15 sec.	50 sec.	40 sec.
Salmon Steaks	224 (8 oz.)	Defrost. Refrigerate, covered.	Place on plate, brush with butter, cover.	HIGH	1 min.	45 sec.	35 sec.
Scallops, Bay	140 g (5 oz.)	Defrost slightly. Refrigerate, covered.	Place in microwave pan, dot with butter and cover.	HIGH	45 sec.	35 sec.	30 sec.
Shrimp, large	168 g (6 oz.)	Defrost. Refrigerate, covered.	Place on plate and cover.	HIGH	45 sec.	35 sec.	30 sec.
Snapper, Red fillets	140 g (5 oz.)	Defrost. Refrigerate, covered.	Place on plate, brush with butter and herbs and cover.	HIGH	1 min.	45 sec.	35 sec.
Sole, stuffed with crabmeat	168 g (6 oz.)	Defrost. Refrigerate, covered.	Place on plate and cover.	HIGH	1 min. 15 sec.	50 sec.	40 sec.

Fish/Seafood, Frozen—Defrosting (To calculate time, use 15 seconds times (x) ounce)

Item	Quantity	Instructions for Pre-preparation	Instructions for Microwave Heating	Power Setting	Approximate Times		
					NE-1257 NE-1258	NE-1757	NE-2157
Lobster Tail (frozen)	224 g (8 oz.)		Place on plate and cover. After DEFROST cycle, let rest 5 min. and refrigerate or cook.	DEFROST		Use calculation Above	
Perch, fillets (frozen)	450 g (1 lb.)		Place in microwave pan and cover. Halfway through defrost, turn over and if possible, rearrange fillets. After DEFROST cycle, let rest 5 min. and refrigerate or cook.	DEFROST		Use calculation Above	
Shrimp, large (frozen)	168 g (6 oz.)		Place on plate and cover. After DEFROST cycle, refrigerate or cook.	DEFROST		Use calculation Above	

Gravies, Sauces and Soups

Some water-based gravies, sauces, and soup mixes may be prepared in large portions using this oven to heat water and thicken the blended mixes.

Refrigerated gravies, sauces, and soups can be reheated quickly at HIGH and may require stirring during heating to produce an even temperature.

Gravies

Item	Quantity	Instructions for Pre-preparation	Instructions for Microwave Heating	Power Setting	Approximate Times		
					NE-1257 NE-1258	NE-1757	NE-2157
Brown gravy	1 qt.	Prepare conventionally or heat ingredients in microwave, if recommended. Refrigerate gravy.	Place in microwave pan. Cover, stir mid-way through heating.	HIGH	7 min.	5 min. 30 sec.	4 min. 30 sec.
Chicken gravy	1 qt.			HIGH	7 min.	5 min. 30 sec.	4 min. 30 sec.

Sauces

Item	Quantity	Instructions for Pre-preparation	Instructions for Microwave Heating	Power Setting	Approximate Times		
					NE-1257 NE-1258	NE-1757	NE-2157
Au jus	1 qt.	Prepare conventionally or heat ingredients in microwave, if recommended. Refrigerate sauce.	Place in microwave pan. Cover, stir mid-way through heating.	HIGH	7 min.	5 min. 30 sec.	4 min. 30 sec.
Cheese sauce	1 qt.			HIGH	8 min.	6 min. 30 sec.	5 min. 30 sec.
Espagnole (stock base)	1 qt.			HIGH	7 min.	5 min. 30 sec.	4 min. 30 sec.
Mushroom sauce	1 qt.			HIGH	7 min.	5 min. 30 sec.	4 min. 30 sec.
Tomato sauce	1 qt.			HIGH	7 min.	5 min. 30 sec.	4 min. 30 sec.
White sauce (Bechamel)	1 qt.			HIGH	7 min.	5 min. 30 sec.	4 min. 30 sec.
White sauce (stock base)	1 qt.			HIGH	7 min.	5 min. 30 sec.	4 min. 30 sec.

Soups

Item	Quantity	Instructions for Pre-preparation	Instructions for Microwave Heating	Power Setting	Approximate Times		
					NE-1257 NE-1258	NE-1757	NE-2157
Beef broth	1 qt.	Prepare conventionally or heat ingredients in microwave, if recommended. Refrigerate soup.	Place in microwave pan. Cover. Stir mid-way through heating.	HIGH	7 min.	5 min. 30 sec.	4 min. 30 sec.
Chicken Noodle soup	1 qt.			HIGH	7 min.	5 min. 30 sec.	4 min. 30 sec.
Clam chowder	1 qt.			HIGH	7 min.	5 min. 30 sec.	4 min. 30 sec.

Plated Meat and Poultry Entrees

Meat and poultry can be reheated successfully in this oven.

Undercook meat slightly. Arrange meat or poultry slices in single layer, overlapping pieces as little as possible.

CAUTION

Pork products must be fully cooked prior to reheating.

When appropriate, cover meats or poultry evenly with sauces.

Item	Quantity	Instructions for Pre-preparation	Instructions for Microwave Heating	Power Setting	Approximate Times		
					NE-1257 NE-1258	NE-1757	NE-2157
Beef, prime rib au jus	336 g (12 oz.)	Prepare conventionally, refrigerate, covered.	Place on plate and top meat with au jus. Cover.	HIGH	2 min.	1 min. 20 sec.	1 min.
Beef stew	224 g (8 oz.)	Prepare conventionally, refrigerate, covered.	Put in small bowl, stir midway through heating, cover.	HIGH	1 min.	45 sec.	35 sec.
Beef stroganoff with noodles	224 g (8 oz.)	Prepare conventionally, refrigerate, covered.	Place on plate, cover.	HIGH	35 sec.	45 sec.	15 sec.
Chicken, BBQ	252 g (9 oz.)	Prepare conventionally, refrigerate, covered.	Place on plate, cover. After 30 sec. of heating, spoon additional sauce evenly over chicken, if desired.	HIGH	1 min. 30 sec.	1 min.	45 sec.
Chicken, breaded, fried	224 g (8 oz.)	Prepare conventionally, refrigerate, covered.	Place on plate, uncovered.	HIGH	60 sec.	45 sec.	35 sec.
Chicken, broiled	1/2 ea.	Prepare conventionally, refrigerate, covered.	Place on plate, cover.	HIGH	1 min. 30 sec.	1 min.	45 sec.
Chicken pieces, with potatoes, dressing and gravy	336 (12 oz.)	Prepare all components conventionally, refrigerate, covered.	Place on plate, depress potatoes, and cover.	HIGH	3 min.	2 min.	1 min. 30 sec.
Cornish hen	1 ea. (22 oz.)	Prepare conventionally, refrigerate, covered.	Place on plate and cover.	HIGH	2 min. 30 sec.	2 min.	1 min. 30 sec.
Duck	1/2 ea.	Prepare conventionally, refrigerate, covered.	Place on plate, cover.	HIGH	3 min.	2 min.	1 min. 30 sec.
Burrito	224 g (8 oz.)	Prepare conventionally, refrigerate, covered.	Place on plate, cover.	HIGH	1 min.	45 sec.	35 sec.
Meat loaf with gravy	196 g (7 oz.)	Prepare conventionally, refrigerate, covered.	Arrange slices in single layer on plate, cover with gravy. Cover.	HIGH	1 min. 10 sec.	50 sec.	45 sec.
Green peppers, stuffed	168 g (6 oz.)	Prepare conventionally, refrigerate, covered.	Place on plate, cover.	HIGH	1 min. 45 sec.	1 min. 15 sec.	50 sec.
Pork chop, stuffed	196 g (7 oz.)	Prepare conventionally, refrigerate, covered.	Place on plate, cover.	MEDIUM	2 min.	1 min. 30 sec.	1 min. 10 sec.
Ribs, short	224 g (8 oz.)	Prepare conventionally, refrigerate, covered.	Place on plate, cover.	HIGH	1 min.	45 sec.	35 sec.
Ribs, spare	448 g (16 oz.)	Prepare conventionally, refrigerate, covered.	Place on plate, cover.	HIGH	2 min.	1 min. 30 sec.	1 min. 10 sec.
Salisbury steak	196 g (7 oz.)	Prepare conventionally, refrigerate, covered.	Place on plate, cover.	MEDIUM	2 min.	1 min. 30 sec.	1 min. 10 sec.
Turkey, sliced with gravy	336 g (12 oz.)	Prepare conventionally, refrigerate, covered. with gravy. Cover.	Arrange slices in single layer on plate, cover	HIGH	1 min. 10 sec.	50 sec.	45 sec.

Rice and Pasta

For best results: reheat covered at HIGH power. Adding moisture, such as a sauce, can facilitate reheating though its not essential.

Rice and pasta dishes with cheese sauce, require more stirring than tomato-based sauces to avoid over-heating and stringiness of cheese.

Rice

Item	Quantity	Instructions for Pre-preparation	Instructions for Microwave Heating	Power Setting	Approximate Times		
					NE-1257 NE-1258	NE-1757	NE-2157
Chicken rice pilaf	112 g (4 oz.)	Prepare conventionally, undercook slightly, refrigerate, covered.	Place on plate, cover.	HIGH	50 sec.	35 sec.	25 sec.
Rice, long grain and wild rice	112 g (4 oz.)	Prepare conventionally, undercook slightly, refrigerate, covered.	Place on plate, cover.	HIGH	50 sec.	35 sec.	25 sec.

Pasta

Item	Quantity	Instructions for Pre-preparation	Instructions for Microwave Heating	Power Setting	Approximate Times		
					NE-1257 NE-1258	NE-1757	NE-2157
Lasagna	224 g (8 oz.)	Prepare conventionally, undercook slightly, refrigerate, covered.	Place on plate, cover. Cut in half, let rest 1 min. after heating.	HIGH	2 min.	1:30 min.	1:30 min.
				MED	1:30 min.	1:00 min.	50 sec.
Macaroni and cheese	224 g (8 oz.)	Prepare conventionally, undercook slightly, refrigerate, covered.	Place on plate, cover. Let rest 1 min. after heating.	HIGH	1:30 min.	1:10 min.	50 sec.
Noodles	112 g (4 oz.)	Prepare conventionally, undercook slightly, refrigerate, covered.	Place on plate, cover.	HIGH	45 sec.	30 sec.	20 sec.
Ravioli	168 g (6 oz.)	Prepare conventionally, undercook slightly, refrigerate, covered.	Arrange in single layer on small place, cover.	HIGH	55 sec.	40 sec.	30 sec.
	336 g (12 oz.)	Prepare conventionally, undercook slightly, refrigerate, covered.	Arrange in single layer on small place, cover.	HIGH	2 min.	1 min. 45 sec.	1 min. 10 sec.
Spaghetti with meat sauce	336 g (12 oz.)	Prepare conventionally, keeping spaghetti and sauce separate, refrigerate, covered.	Place on plate, cover with sauce, cover.	HIGH	1 min. 50 sec.	1 min. 30 sec.	1 min. 15 sec.

Sandwiches

Preassembled sandwiches can be heated quickly and easily in this microwave oven. For best results, assemble sandwiches no more than three hours in advance.

Meat fillings such as hamburgers and sausage should be precooked and preferably not be more than 1/2 inch thick.

Day-old, toasted breads, or breads whose formula is enriched with egg or fat are advantageous because they tend to become less soggy when heated.

Thin sliced meats, lightly packed, allow for more even heating. Place meat over bread.

All but openfaced sandwiches should be heated uncovered on absorbent material such as paper towel or napkin to prevent sogginess.

Item	Quantity	Instructions for Pre-preparation	Instructions for Microwave Heating	Power Setting	Approximate Times		
					NE-1257 NE-1258	NE-1757	NE-2157
BBQ beef on bun	168 g (6 oz.)	Prepare beef conventionally, refrigerate, covered. Toast bun.	Assemble, place on paper napkin on plate, uncovered.	HIGH	60 sec.	45 sec.	35 sec.
Corned beef on rye	140 g (5 oz.)	Assemble, refrigerate, covered.	Place on paper towel, Uncovered.	HIGH	60 sec.	45 sec.	35 sec.
French dip	168 g (6 oz.)	Assemble, refrigerate, covered.	Place on plate with au jus over beef and on side, uncovered.	HIGH	60 sec.	45 sec.	35 sec.
Grilled cheese	112 g (4 oz.)	Prepare conventionally, refrigerate, covered.	Place on paper towel, uncovered.	HIGH	60 sec.	45 sec.	35 sec.
Hamburger, plain	140 g (5 oz.)	Prepare burger conventionally. Toast bun. Assemble, refrigerate, covered.	Place on paper towel, uncovered.	HIGH	60 sec.	45 sec.	35 sec.
with cheese	140 g. (5oz.)			HIGH	1 min. 5 sec	50 sec.	40 sec.
Hot dog	84 g (3 oz.)	Prepare conventionally. Toast bun. Assemble, refrigerate, covered.	Wrap loosely in plastic.	HIGH	55 sec.	40 sec.	30 sec.
Pastrami on rye	140 g (5 oz.)	Assemble, refrigerate, covered.	Place on paper towel, uncovered.	HIGH	60 sec.	45 sec.	35 sec.
Reuben	168 g (6 oz.)	Prepare conventionally, refrigerate, covered.	Place on paper towel, uncovered.	HIGH	60 sec.	45 sec.	35 sec.
Roast beef, open-face with gravy	224 g (8 oz.)	Prepare beef and gravy conventionally, refrigerate, covered. Toast bread.	Assemble, plate, cover.	HIGH	60 sec.	45 sec.	35 sec.
Sausage, Italian on sub roll	154 g (5 1/2 oz.)	Prepare sausage conventionally. Toast roll. Assemble, refrigerate, covered.	Place on paper towel, uncovered.	HIGH	60 sec.	45 sec.	35 sec.
Turkey, open-face with gravy	224 g (8 oz.)	Prepare turkey and gravy conventionally, refrigerate, covered. Toast bread.	Assemble, plate, cover.	HIGH	60 sec.	45 sec.	35 sec.

Vegetables

Most vegetables, small and bulk portions, defrost, heat, and cook very successfully in the microwave, retaining fresh color and texture as well as nutritional value. The thicker and more fibrous the vegetable, the longer the cooking time. (ie. Root vegetables.)

Icy sections should be broken up during heating for even temperature distribution.

Canned vegetables can be heated using HIGH in approximately 1 minute per pound.

Frozen vegetables can be defrosted and heated in one step. One to two tablespoons of water should be added to frozen vegetables.

Most fresh vegetables are prepared with a small amount of cooking liquid such as water.

Vegetables, Frozen—Defrosting and Heating

Item	Quantity	Instructions for Pre-preparation	Instructions for Microwave Heating	Power Setting	Approximate Times		
					NE-1257 NE-1258	NE-1757	NE-2157
Beans, green	4 lb.	NONE	Place in a microwave safe 6" half pan. Add one to two tablespoons of water. Cover with lid. Let stand, covered, 2 minutes.	HIGH	4 min./lb.	3 min./lb.	2 min./lb.
	6 lb.	NONE		HIGH			
Cauliflower	4 lb.	NONE		HIGH			
	6 lb.	NONE		HIGH			
Broccoli	4 lb.	NONE		HIGH			
Carrots, sliced	6 lb.	NONE		HIGH			

Vegetable, Fresh—Heating

Item	Quantity	Instructions for Pre-preparation	Instructions for Microwave Heating	Power Setting	Approximate Times			
					NE-1257 NE-1258	NE-1757	NE-2157	
Carrots & other root vegetables	(cook)	4 lb.	Peel carrots; cut into 1/8" slices.	Wash vegetables well. Cut into uniform size pieces. Place in microwave safe Cambro 4" half pan. Cover with lid. Stir midway through heating. After heating, let stand, covered, 2 minutes.	HIGH	8 min.	6 min.	5 min.
		5 lb.			HIGH	10 min.	7:30 min.	6:30 min.
		6 lb.			HIGH	12 min.	9 min.	8 min.
		7 lb.			HIGH	13:30 min.	10:30 min.	9:30 min.
	(blanch)	4 lb.	Peel carrots; cut into 1/8" slices.	Wash vegetables well. Cut into uniform size pieces. Place in microwave safe Cambro 4" half pan. Add 3 to 4 tablespoons of water. Stir midway through heating. After heating let stand, covered, 2 minutes.	HIGH	6 min.	4 min.	3 min.
		5 lb.			HIGH	8:50 min.	5:30 min.	4:30 min.
		6 lb.			HIGH	10 min.	7 min.	6 min.
		7 lb.			HIGH	11:30 min.	8:30 min.	7:30 min.

Vegetable Fresh—Primary Cooking

Item	Quantity	Instructions for Pre-preparation	Instructions for Microwave Heating	Power Setting	Approximate Times		
					NE-1257 NE-1258	NE-1757	NE-2157
Broccoli	3 lb.	Rinse broccoli. Cut into spears.	Place in a microwave safe Cambro 6" half pan. Add 2 tablespoons of water. Cover. After cooking, let stand, covered, 2 minutes.	HIGH	10 min.	7 min.	5 min.
Baked Potatoes	8 pcs. (100 ct.)	Wash and pierce several times with fork. Arrange evenly on paper towel in oven.	Place in a microwave safe Cambro 6" half pan. Add 2 tablespoons of water. Cover. After cooking, let stand, covered, 2 minutes.	HIGH	8 min.	7 min.	6 min.
Refried beans	6 lb. 6 oz. (#10 can)	Open can.	Place in a microwave safe Cambro 6" half pan. Cover with lid. After cooking, let stand 2 minutes.	HIGH	8 min.	6:30 min.	5 min.

Casseroles

Food-Service casseroles can be cooked successfully in this microwave oven. For best results, follow instructions below.

Preparation

Remove all casseroles from their foil baking trays, while still frozen and place in a microwave safe 4-inch half pan. Place in refrigerator and thaw for about 30 minutes per ounce.

Let stand 15 minutes before serving.

Casseroles, Frozen—Heating

Item	Quantity	Instructions for Pre-preparation	Instructions for Microwave Heating	Power Setting	Approximate Times		
					NE-1257 NE-1258	NE-1757	NE-2157
Vegetable Lasagna	Calculate Min/Lb	Place in 4" half pan. Thaw in refrigerator for approx. 4 days.	Cover with lid. Let stand 15 minutes before serving.	1st Stage HIGH	2:30 min. per lb.	1:30 min. per lb.	1 min. per lb.
				2nd Stage MED	2:30 min. per lb.	1:30 min. per lb.	1 min. per lb.
Spinach Souffle	Calculate Min/Lb	Place in 4" half pan. Thaw in refrigerator for approx. 2 days.	Cover with lid. Let stand 15 minutes before serving.	1st Stage MED	2:30 min. per lb.	1:30 min. per lb.	1 min. per lb.
				2nd Stage HIGH	2:30 min. per lb.	1:30 min. per lb.	1 min. per lb.
Deep Dish Cherry Crisp	Calculate Min/Lb	Place in 4" half pan. Thaw in refrigerator	Sprinkle with 2 tablespoons of sugar.	HIGH	2:30 min. per lb.	1:30 min. per lb.	1 min. per lb.
Macaroni and Cheese	Calculate Min/Lb	Place in 4" half pan. Thaw in refrigerator for approx. 2 days.	Cover with lid. Stir after cooking.	HIGH	2:30 min. per lb.	1:30 min. per lb.	1 min. per lb.
Burritos	Calculate Min/Lb	Place on paper towel.	Heat covered.	HIGH	2:30 min. per lb.	1:30 min. per lb.	1 min. per lb.

Instructions for all casseroles & large items (4 lbs. or more) that are ordinarily baked:

- 1) Defrost (see defrost method on page 29).
- 2) Heat: From refrigerated temperatures (< 40°F and > 32°F)
 - Stage 1 = High time per lb.
 - Stage 2 = Medium time per lb.

Technical Specifications

	NE-1257A / NE-1258A	NE-1757A	NE-2157A
Power Source	120 V, 60 Hz, Single Phase	208/230 V, 60 Hz, Single Phase	
Required Power (Voltage)	17.7 A (120 V)	14.3 A (208 V) 13.3 A (230 V)	16.6 A (208 V) 15.3 A (230 V)
Receptacle Required	20 AMP NEMA #5-20R	15 AMP NEMA #6-15R 20 AMP NEMA #6-20R	20 AMP NEMA #6-20R
Output*	HI 1200 W MED 600 W DEF 340 W	HI 1700 W MED 850 W DEF 340 W	HI 2100 W MED 1050 W DEF 340 W
Operating Frequency	2450 MHz	2450 MHz	2450 MHz
Outside Dimensions (W x D x H)	16 ⁵ / ₈ " x 20" x 13 ³ / ₁₆ " (422mm x 508mm 335mm)		
Oven Cavity Dimensions (H x W x D) (approx.)	13" x 12 ³ / ₃₂ " x 6 ⁷ / ₈ " (330mm x 310mm x 175mm)		
Net Weight	58 lbs., 26.3 kgs	62 lbs., 28.3 kgs	65 lbs., 29.5 kgs
Timer	30 min (digit) / 10 touch pads Maximum programmable time for each stage heating (3 stages - max) HIGH & MED power = 15 min. DEF power = 30 min.		

*IEC 705-88 Test Procedure

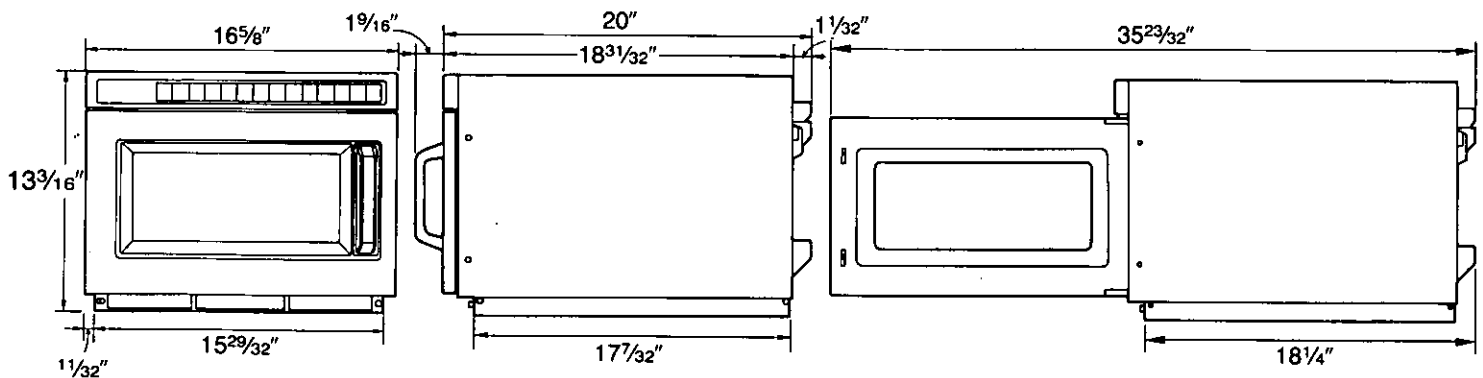

Panasonic®

Panasonic Home & Commercial
Products Company, Division of Matsushita
Electric Corporation of America
One Panasonic Way 4A-4
Secaucus, New Jersey 07094
Call (201) 348-5377

B00033654AP
S0998

Specifications subject to change without notice. Printed in U.S.A.