

This Owner's Manual is provided and hosted by [Appliance Factory Parts](#).



# PANASONIC NN-S262 Owner's Manual

[Shop genuine replacement parts for PANASONIC  
NN-S262](#)



[Find Your PANASONIC Microwave Parts - Select From 742 Models](#)

----- Manual continues below -----

**Panasonic®**

# Operating Instructions

Microwave Oven  
Models NN-S262  
NN-S252

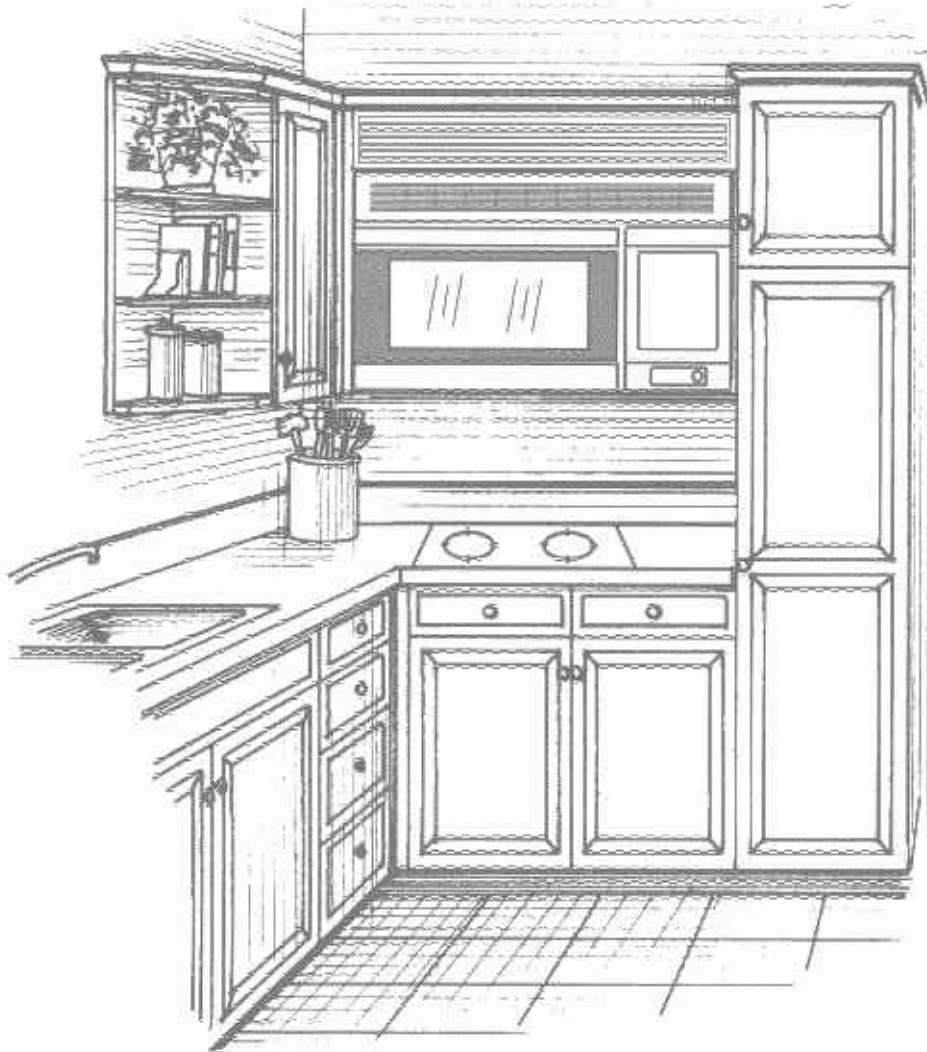

This manual contains Safety Instructions, Operating Instructions and Maintenance of the oven.  
Before operating this oven, please read these instructions completely.  
Antes de operar este producto, lea este instructivo en su totalidad.  
El manual de instrucciones en español puede ser encontrada en la páginas 33-38  
(Spanish Operating Instructions can be found on pages 33-38)

For assistance, please call :1-800-211-PANA(7262)  
or send e-mail to :consumerproducts@panasonic.com  
or visit us at [www.panasonic.com](http://www.panasonic.com)

(U.S.A)

For assistance, please call : 787-750-4300  
or visit us at [www.panasonicpr.com](http://www.panasonicpr.com)

(Puerto Rico)

Thank you for purchasing a Panasonic Microwave Oven.

## PRECAUTIONS TO AVOID POSSIBLE EXPOSURE TO EXCESSIVE MICROWAVE ENERGY

- (a) Do not attempt to operate this oven with the door open since open-door operation can result in harmful exposure to microwave energy. It is important not to defeat or tamper with the safety interlocks. Under normal conditions oven will not operate with door open.
- (b) Do not place any object between the oven front face and the door, or allow soil or cleaner residue to accumulate on sealing surfaces.
- (c) Do not operate the oven if it is damaged. It is particularly important that the oven door close properly and that there is no damage to the:
  - (1) door (bent)
  - (2) hinges and latches (broken or loosened)
  - (3) door seals and sealing surfaces.
- (d) The oven should not be adjusted or repaired by anyone except properly qualified service personnel.

## Technical Specifications

	NN-S262	NN-S252
Power Source	120 V, 60 Hz	120 V, 60 Hz
Power Consumption	12.2 A 1,430W	12.2 A 1,430W
Output*	1,200 W	1,200 W
Outside Dimensions (H x W x D)	16 <sup>7</sup> / <sub>16</sub> " x 29 <sup>7</sup> / <sub>8</sub> " x 15" 418 x 759 x 381 mm	16 <sup>7</sup> / <sub>16</sub> " x 29 <sup>7</sup> / <sub>8</sub> " x 15" 418 x 759 x 381 mm
Oven Cavity Dimensions (H x W x D)	9 <sup>1</sup> / <sub>2</sub> " x 23 <sup>1</sup> / <sub>4</sub> " x 14 <sup>7</sup> / <sub>16</sub> " 242 x 591 x 367 mm	9 <sup>1</sup> / <sub>2</sub> " x 23 <sup>1</sup> / <sub>4</sub> " x 14 <sup>7</sup> / <sub>16</sub> " 242 x 591 x 367 mm
Charcoal Filter (option)	NN-CF208P	NN-CF208P
Operation Frequency	2,450 MHz	2,450 MHz
Uncrated Weight (Approx.)	Approx. 55 lbs. (25.0 kg)	Approx. 53 lbs. (24.0 kg)

\*IEC 60705 Test procedure

Specifications subject to change without notice.

The serial number of this product may be found on the right side of the oven door opening. You should note the model number and the serial number of this oven in the space provided and retain this book as a permanent record of your purchase for future reference.

Model No. \_\_\_\_\_

Serial No. \_\_\_\_\_

Date of Purchase \_\_\_\_\_

© Copyrighted by Matsushita Electric Industrial Co., Ltd., 2002.

# Correction Sheet / Fe de erratas

## Page 27

<b>ORDER FORM</b>	
<b>DESCRIPTION</b>	<b>PART NUMBER</b>
Instruction / Operating Manual (this book)	F00035H00AP
Glass Tray	A06015H00AP
Shelf (Metal Rack: NN-S262 only)	F06025H00AP
Roller Ring Assembly	J290D-4N30BP
Oven Light, Cooktop Light	F60305H00AP

For pricing quotes, call or write the Parts & Literature Department at the phone or address listed below. Please have your credit card information readily available.  
*Shipping & handling are not included. Price & availability subject to change. Sorry, no COD's.*

## Page 35

### Especificaciones Técnicas

	<b>NN-S262</b>	<b>NN-S252</b>
Tensión de Alimentación:	120 V, 60 Hz	120 V, 60 Hz
Potencia Fuente de Poder:	12,2 A 1 430 W	12,2 A 1 430 W
Potencia de Salida:*	1 200 W	1 200 W
Dimensiones Exteriores (Ancho x Alto x Fondo):	418 mm x 759 mm x 381 mm	418 mm x 759 mm x 381 mm
Dimensiones Cavity del Horno (Ancho x Alto x Fondo):	242 mm x 591 mm x 367 mm	242 mm x 591 mm x 367 mm
Filtro de Carbón: (option)	NN-CF208P	NN-CF208P
Frecuencia:	2 450 MHz	2 450 MHz
Peso Sin Embalaje:	Approx. 25,0 kg	Approx. 24,0 kg

# TABLE OF CONTENTS

## **SAFETY**

Important Safety Instructions .....	4-5
Installation Instructions .....	5
Installation & Grounding Instructions .....	6
Safety Precautions .....	7
Cookware and Utensil Guide .....	8
Feature Diagram .....	9
Control Panel (NN-S262) .....	10
Control Panel (NN-S252) .....	11

## **OPERATION**

To Use Function Pad .....	12
Clock Setting .....	13
Light On/Night/Off .....	13
Turntable On/Off .....	13
Fan High/Low/Off .....	13
Turbo Fan On/Off .....	13
Auto Off 1/3/5/10 .....	13
Power & Time Setting .....	14
To Use Popcorn Pad .....	14
Quick Min Function .....	15
To Use Keep Warm Pad .....	15
Inverter Turbo Defrost .....	15
Defrost Tips & Techniques .....	16
Sensor Reheat (NN-S262) .....	17
Sensor Cook (NN-S262) .....	17
Sensor Cook Chart .....	18
Sensor Cook Recipe .....	19
Auto Reheat (NN-S252) .....	20
Inverter Auto Cooking (NN-S252) .....	20
Inverter Auto Cooking Chart .....	21
Timer Setting .....	22
How to Use Shelf .....	23
Microwave Shortcuts .....	24
Food Characteristics .....	25
Cooking Techniques .....	25

## **MAINTENANCE**

Technical Specifications .....	2
<b>CARE OF YOUR MICROWAVE OVEN</b> .....	27
Cleaning Vent Grill (Oven Air Vent) .....	28
Install Vent Grill .....	28
Charcoal Filter Attachment/Replacement .....	28
Cleaning Grease Filters .....	28
Install Grease Filters .....	28
Cooktop/Night Light Replacement .....	29
Oven Light Replacement .....	29
Before Requesting Service .....	30
Limited Warranty & Customer Services Directory .....	31

<b>INSTRUCCIONES DE SEGURIDAD</b> .....	33-34
Guarde estas Instrucciones .....	33
Instrucciones de Instalación .....	34
Instrucciones para Conexión a Tierra .....	35
Especificaciones Técnicas .....	35
Sugerencias Útiles .....	36
Guía rápida de uso para NN-S262 .....	37
Guía rápida de uso para NN-S252 .....	38
Quick Guide to Operation for NN-S262 .....	39
Quick Guide to Operation for NN-S252 .....	back cover

# IMPORTANT SAFETY INSTRUCTIONS

Your microwave oven is a cooking device and you should use as much care as you use with a stove or any other cooking device. When using this electric appliance, basic safety precautions should be followed, including the following:

**WARNING**—To reduce the risk of burns, electric shock, fire, injury to persons, or exposure to excessive microwave energy:

1. Read all instructions before using the appliance.
2. Read and follow the specific "PRECAUTIONS TO AVOID POSSIBLE EXPOSURE TO EXCESSIVE MICROWAVE ENERGY," found on page 2.
3. This appliance must be grounded. Connect only to properly grounded outlet. See "GROUNDING INSTRUCTIONS" found on page 6.
4. Install or locate this appliance only in accordance with the installation instructions found on page 5.
5. Do not cover or block any openings on this appliance.
6. Do not store or use this appliance outdoors. Do not use this product near water—for example, near a kitchen sink, in a wet basement, or near a swimming pool, and the like.
7. Use this appliance only for its intended use as described in this manual. **DO NOT** use corrosive chemicals, vapours, or non-food products in this appliance. This type of oven is specifically designed to heat, or cook food. It is not designed for industrial or laboratory use. The use of corrosive chemicals in heating or cleaning will damage the appliance and may result in radiation leaks.
8. When cleaning surfaces of door and oven that come together on closing the door, use only mild, non-abrasive soaps or detergents applied with a sponge or soft cloth.
9. Do not allow children to use this appliance, unless closely supervised by an adult.
10. Do not operate this appliance if it has a damaged cord or plug, if it is not working properly, or if it has been damaged or dropped.
11. Do not immerse cord or plug in water.
12. Keep cord away from heated surfaces.
13. Do not let cord hang over edge of a table or counter.
14. This appliance should be serviced only by qualified service personnel. Contact the nearest authorized servicenter for examination, repair or adjustment.
15. Some products such as whole eggs, narrow neck bottles and sealed containers—for example, closed glass jars—may explode and should not be heated in this oven.
16. To reduce the risk of fire in the oven cavity:
  - (a) Do not overcook food. Carefully attend appliance if paper, plastic, or other combustible materials are placed inside the oven to facilitate cooking.
  - (b) Remove wire twist-ties from paper or plastic bags before placing bag in oven.
  - (c) **If materials inside the oven should ignite, keep oven door closed, turn oven off, and disconnect the power cord, or shut off power at the fuse or circuit breaker panel.**
  - (d) Do not use the cavity for storage purposes. Do not leave paper products, cooking utensils, or food in the cavity when not in use.
17. Liquids, such as water, coffee, or tea are able to be overheated beyond the boiling point without appearing to be boiling due to surface tension of the liquid. Visible bubbling or boiling when the container is removed from the microwave oven is not always present. **THIS COULD RESULT IN VERY HOT LIQUIDS SUDDENLY BOILING OVER WHEN A SPOON OR OTHER UTENSIL IS INSERTED INTO THE LIQUID.** To reduce the risk of injury to persons:
  - (a) Do not overheat the liquid.
  - (b) Stir the liquid both before and halfway through heating it.
  - (c) Do not use straight-sided containers with narrow necks.
  - (d) After heating, allow the container to stand in the microwave oven for a short time before removing the container.
  - (e) Use extreme care when inserting a spoon or other utensil into the container.
18. This appliance is suitable for use above both gas and electric cooking equipment 36 inches (91.4 cm) or less wide. To reduce the risk of fire and electric shock, install at least 13 $\frac{5}{8}$  inches (34.4 cm), above a cooktop.
19. Clean Ventilating Hoods Frequently – Grease should not be allowed to accumulate on hood or filter.
20. Use care when cleaning the Grease filter. Corrosive cleaning agents, such as lye-based oven cleaners, may damage the filter. Clean in hot detergent solution every month.
21. When flaming foods under the hood, turn the fan on.

## Glass Tray (Turntable)

1. **DO NOT** operate the oven without Roller Ring and Glass Tray in place.
2. **DO NOT** operate the oven without the Glass Tray fully engaged on the drive hub. Improper cooking or damage to the oven could result. Verify that the Glass Tray is properly engaged and rotating by observing its rotation when you press Start.
3. Only use the Glass Tray specifically designed for this oven. Do not substitute any other glass tray.
4. Sometimes the Glass Tray can become too hot to touch. Be careful touching the Glass Tray during and after cooking. If the Glass Tray is hot, allow to cool before cleaning or placing in water.
5. **DO NOT** cook directly on the Glass Tray. Always place food in a microwave-safe dish, or on a rack set in a microwave-safe dish.
6. If food or utensil on Glass Tray touches oven walls, causing the tray to stop moving, the tray will automatically rotate in the opposite direction. This is normal.
7. Glass Tray can turn in either direction.
8. Even when operating "Turntable off" mode, place Roller Ring and Glass Tray correctly.

## Roller Ring

1. Roller Ring and oven floor should be cleaned frequently to prevent excessive noise.
2. Roller Ring must always be used for cooking along with Glass Tray.
3. Always replace Roller Ring and Glass Tray in their proper positions.

# SAVE THESE INSTRUCTIONS

For proper use of your oven read remaining safety cautions and operating instructions.

# IMPORTANT SAFETY INSTRUCTIONS

## General Use

1. **DO NOT** tamper with or make any adjustments or repairs to door, Control Panel housing, safety interlock switches or any other part of the oven. **DO NOT** remove outer panel from oven. Repairs must only be done by a qualified service person.
2. **DO NOT** operate the oven empty. The microwave energy will reflect continuously throughout the oven causing overheating, if food or water is not present to absorb energy. This could damage the oven and result in the risk of a fire.
3. **DO NOT** dry clothes, newspapers or other materials in oven, or use newspapers or paper bags for cooking. Fire could result.
4. **DO NOT** use recycled paper products unless the paper product is labeled as safe for microwave oven use. Recycled paper products may contain impurities which may cause sparks, and result in fires when used.
5. **DO NOT** hit or strike Control Panel. Damage to controls may occur. Fire could result.
6. **POT HOLDERS** should always be used when removing items from the oven. Heat is transferred from the **HOT** food to the cooking container and from the cooking container to the Glass Tray. The Glass Tray can be very **HOT** after removing the cooking container from the oven.
7. **DO NOT** store flammable materials next to, on top of, or in the oven. These could be fire hazards.
8. When using **BOTH** the range and the microwave oven at the same time, take caution not to burn yourself when leaning over the range to reach into the microwave oven.

# INSTALLATION INSTRUCTIONS

## Examine Your Oven

Unpack oven, remove all packing material and examine the oven for any damage such as dents, broken door latches or cracks in the door. Notify dealer immediately if oven is damaged. **DO NOT** install if oven is damaged.

## Installation

1. This oven is designed for installation over a range in a standard 30" (76 cm) opening.
2. Be sure to install this oven only in accordance with the additional installation instructions provided.
3. It is recommended that the product be mounted to a flush wall of 2" x 4" (5 x 10cm) stud and  $\frac{3}{8}$ " (1cm) minimum thickness drywall or plaster/lath. For further information, please consult the additional installation instructions provided.
4. Make sure the bottom of the top cabinet is 66" (1.67 m) or more from the floor and 30" (76 cm) or more from the cooking surface.
5. This oven was manufactured for household use only.

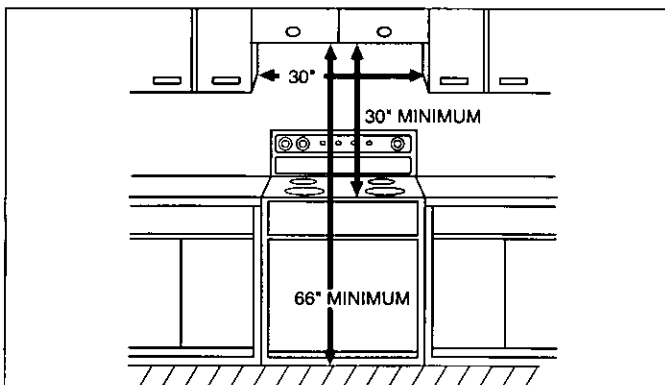

# INSTALLATION & GROUNDING INSTRUCTIONS

## Grounding Instructions

**This appliance must be grounded.** In the event of an electrical short circuit, grounding reduces the risk of electric shock by providing an escape wire for the electric current. This appliance is equipped with a cord having a grounding wire with a grounding plug. The plug must be plugged into an outlet that is properly installed and grounded.

**WARNING**—Improper use of the grounding plug can result in a risk of electric shock. Consult a qualified electrician or service person if the grounding instructions are not completely understood, or if doubt exists as to whether the appliance is properly grounded.

## Wiring Requirements

1. The oven must be on a **SEPARATE CIRCUIT**. No other appliance should share the circuit with the microwave oven. If it does, the branch circuit fuse may blow, the circuit breaker may trip, or the food may cook slower than the times recommended in this manual.
2. The **VOLTAGE** used must be the same as specified on this microwave oven (120 V, 60 Hz). Using a higher voltage is dangerous and may result in a fire or other incident causing oven damage. Using a lower voltage will cause slow cooking. Panasonic is **NOT** responsible for damages resulting from the use of the oven with any voltage other than specified.
3. The oven must be plugged into at least a **20 AMP, 120 VOLT, 60 Hz GROUNDED OUTLET**. Where a standard two-prong outlet is encountered, it is the personal responsibility and obligation of the consumer to have it replaced with a properly grounded three-prong outlet.

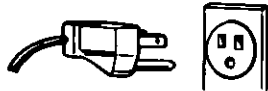

## TV/Radio Interference

1. Operation of the microwave oven may cause interference to your radio, TV or similar equipment.
2. When there is interference, it may be reduced or eliminated by taking the following measures:
  - (a) Clean door and sealing surfaces of the oven. (See Care of Your Microwave Oven)
  - (b) Place the radio, TV, etc. away from the microwave oven as far as possible.
  - (c) Use a properly installed antenna to obtain stronger signal reception.

## The Hood

1. The vent fan in your oven will operate automatically under certain conditions. Caution is required to prevent the starting and spreading of accidental cooking fires while the vent fan is in operation.
2. Never leave surface units unattended at high heat setting. Boil over causes smoking and greasy spillovers that may ignite and spread if vent fan is operating. To minimize automatic fan operation, use adequate sized utensils and use high heat settings only when necessary.
3. In the event of a grease fire, smother flaming pan on surface unit by covering pan completely with well-fitting lid, cookie sheet or flat tray.
4. Keep hood and grease filters clean, according to instructions on page 28, to maintain adequate venting and avoid grease fires.
5. To protect the automatic fan feature, always keep the filter clean (see page 28). Should the fan require repair, do not operate microwave oven until it has been repaired.
6. Charcoal filter should be replaced periodically. It may be purchased from a local Panasonic dealer.

## Indoor Venting

If this appliance is to be vented inside the kitchen, an optional charcoal filter kit (NN-CF208P) should be installed in the unit before you operate. Additional charcoal filter kits can be purchased from your local Panasonic dealer.

## Fan Motor Operation

After using the oven repeatedly or for long time, the fan may operate to cool the electric components. This is perfectly normal, and you can take out the food from the oven while the fan operates.



# SAFETY PRECAUTIONS

## Follow These Safety Precautions When Cooking in Your Oven.

### IMPORTANT

Proper cooking depends upon the power, the time set and the quantity of food. If you use a smaller portion than recommended and cook at the time for the recommended portion, fire could result.

#### 1) HOME CANNING / DRYING FOODS / SMALL QUANTITIES OF FOODS

- **DO NOT** use your oven for home canning, your oven cannot maintain the food at the proper canning temperature. Improperly canned food may spoil and be dangerous to consume.
- **DO NOT** dry meats, herbs, fruits or vegetables in your oven. Small quantities of food or foods with low moisture content can dry out, scorch or catch on fire if overheated.

#### 2) POPCORN

Popcorn may be popped in a microwave oven corn popper. Microwave popcorn which pops in its own package is also available. Follow popcorn manufacturers' directions and use a brand suitable for the wattage of your microwave oven.

**CAUTION:** When using pre-packaged microwave popcorn, follow recommended package instructions. Check package weight before using the Popcorn pad (see Popcorn Pad section). Set the oven for the weight of the popcorn package. If these instructions are not followed, the popcorn may not pop adequately or may ignite and cause a fire. Never leave oven unattended when popping popcorn. Allow the popcorn bag to cool before opening, and always open the bag away from your face and body to prevent steam burns.

#### 3) DEEP FAT FRYING

- **DO NOT** attempt to deep fat fry in your microwave oven. Cooking oils may burst into flames and may cause damage to the oven and perhaps result in burns. Microwave utensils may not be able to withstand the temperature of the hot oil, and could shatter or melt.

#### 4) FOODS WITH NONPOROUS SKINS

- **Potatoes, apples, whole eggs, egg yolks, whole squash and sausages are examples of foods with nonporous skins.** These types of foods must be pierced before microwave cooking to prevent their bursting.
- Use fresh potatoes for baking and cook until just done. Use recommended weights for programmed cooking. Overcooking causes dehydration and may result in a fire.

#### 5) GLASS TRAY / COOKING UTENSILS / FOIL

- Cooking utensils get hot during microwaving. Heat is transferred from the HOT food to the container and the Glass Tray. Use potholders when removing utensils from the oven or when removing lids or plastic wrap covers from cooking utensils to avoid burns.
- The Glass Tray will get hot during cooking. It should be allowed to cool before handling or before paper products, such as paper plates or microwave popcorn bags, are placed in the oven for microwave cooking.
- When using foil, skewers, warming rack or utensils made of metal in the oven, allow at least 1-inch (2.5 cm) of space between metal material and interior oven walls. If arcing occurs (sparking), remove metal material (skewers etc.) and/or transfer to a non-metallic container.
- Dishes with metallic trim should not be used, as arcing may occur.
- If an entree is heated in a foil tray, maintain at least 1-inch (2.5 cm) spacing from the oven walls.

#### 6) PAPER TOWELS / CLOTHS

- **DO NOT** use paper towels or cloths which contain a synthetic fiber woven into them. The synthetic fiber may cause the towel to ignite. Use paper toweling under supervision.

#### 7) BROWNING DISHES / OVEN COOKING BAGS

- Browning dishes or grills are designed for microwave cooking only. Always follow instructions provided by the manufacturer. **DO NOT** preheat browning dish more than 6 minutes.
- If an oven cooking bag is used for microwave cooking, prepare according to package directions. **DO NOT** use a wire twist-tie to close bag, instead use plastic ties, cotton string or a strip cut from the open end of the bag.

#### 8) THERMOMETERS

- **DO NOT** use a conventional meat thermometer in your oven. Arcing may occur. Microwave-safe thermometers are available for both meat and candy.

#### 9) BABY FORMULA / FOOD

- **DO NOT** heat baby formula or food in the microwave oven. The glass jar or surface of the food may appear to be only warm while the interior can be so hot as to burn the infant's mouth and esophagus.

#### 10) REHEATING PASTRY PRODUCTS

- When reheating pastry products, check temperatures of any fillings before eating. Some foods have fillings which heat faster and can be extremely hot, while the surface remains warm to the touch (ex. Jelly Donuts).

#### 11) GENERAL OVEN USAGE GUIDELINES

- **DO NOT** use the oven for any reason other than the preparation of food.
- **DO NOT** leave oven unattended while in use.

# COOKWARE AND UTENSIL GUIDE

ITEM	MICROWAVE	COMMENTS
Aluminum Foil	Yes for Shielding only	Small strips of foil can be molded around thin parts of meat or poultry to prevent overcooking. Arcing can occur if foil is too close to oven wall or if too much foil is used.
Browning Dish	Yes	Browning dishes are designed for microwave cooking only. Check browning dish information for instructions and heating chart. Do not preheat for more than 6 minutes.
Brown paper bags	No	May cause a fire in the oven.
Dinnerware Labeled "Microwave-Safe" Other Dinnerware	Yes ?	Check manufacturers' use and care directions for use in microwave heating. Some dinnerware may state on the back of the dish, "Oven-Microwave Safe". Use CONTAINER TEST below.
Disposable polyester Paperboard Dishes	Yes	Some frozen foods are packaged in these dishes. Can be purchased in grocery stores.
Fast Food Carton with Metal Handle	No	Metal handle may cause arcing.
Frozen Dinner Tray Metal	Yes	Frozen dinners may be heated in foil tray, if tray is less than 3/4-in. (2 cm) high. Place foil tray in center of oven. Leave at least 1-in. (2.5 cm) space between foil tray and oven walls.
Microwave-safe	Yes	Heat only 1 foil tray in the oven at a time. For containers more than 3/4-inch (2 cm) deep, remove food and place in a similar size microwave-safe container.
Glass Jars	Yes, use caution	Remove lid. Heat food until just warm, not HOT. Most glass jars are not heat resistant. Do not use for cooking.
Glassware Heat Resistant Oven Glassware & Ceramics	Yes	Ideal for microwave cooking and browning. (See CONTAINER TEST below)
Metal Bakeware	No	Not recommended for use in microwave ovens.
Metal Twist Ties	No	May cause arcing which could cause a fire in the oven.
Oven Cooking Bag	Yes	Follow manufacturers' directions. Close bag with the nylon tie provided, a strip cut from the end of the bag, or a piece of cotton string. Do not close with metal twist tie. Make six 1/2-in. (1 cm) slits near the closure.
Paper Plates & Cups	Yes	Use to warm cooked foods, and to cook foods that require short cooking times such as hot dogs.
Paper Towels & Napkins	Yes	Use to warm rolls and sandwiches by microwave.
Parchment Paper	Yes	Use as a cover to prevent spattering. Safe for use in microwave, microwave/convection and conventional ovens.
Plastic Microwave-Safe Cookware Reheat & Storage	Yes	Should be labelled, "Suitable for Microwave Heating." Check manufacturers' directions for recommended uses.
Melamine	Yes, use caution	Some microwave-safe plastic dishes are not suitable for cooking foods with high fat or sugar content. The heat from hot food may cause the plastic to warp.
	No	This material absorbs microwave energy. Dishes get HOT!
Plastic Foam Cups	Yes	Plastic foam will melt if foods reach a high temperature. Use to bring foods to a low serving temperature.
Plastic Wrap	Yes	Use to cover food during cooking to retain moisture and prevent spattering. Should be labeled "Suitable for Microwave Heating". Check package directions.
Straw, Wicker, Wood	Yes	Use only for short term reheating and to bring food to a low serving temperature.
Thermometers Microwave-safe, only	Yes	Use only microwave-safe meat and candy thermometers. Not suitable for use in microwave oven, will cause sparks and get hot.
Conventional	No	
Wax paper	Yes	Use as a cover to prevent spattering and to retain moisture.

## CONTAINER TEST

**TO TEST A CONTAINER FOR SAFE MICROWAVE OVEN USE:** Fill a 1-cup glass measure with water and place it in the microwave oven along with the container to be tested; **heat one (1) minute at P10 (HIGH)**. If the container is microwave oven-safe (transparent to microwave energy), the container should remain comfortably cool and the water should be hot. If the container is hot, it has absorbed some microwave energy and should NOT be used. This test cannot be used for plastic containers.

# FEATURE DIAGRAM

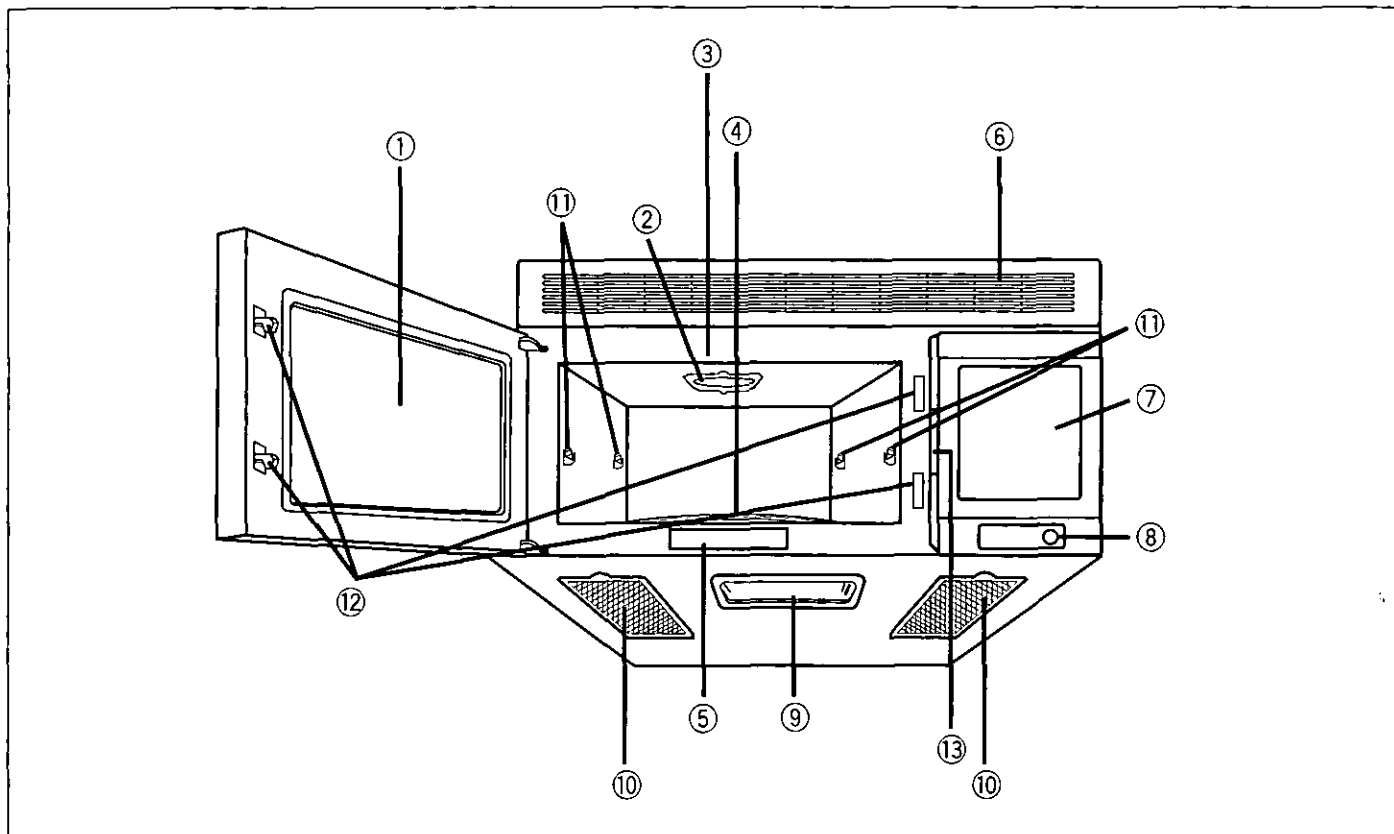

**Shelf**  
(NN-S262 only)  
Shelf can be used for 2-level cooking, see page 23



**Glass Tray**



**Roller Ring**

- ① **See-through Oven Window**
- ② **Cover** (do not remove)
- ③ **Oven Light** (Oven Light can be replaced, see page 29)
- ④ **Glass Tray** (Turntable)
- ⑤ **Menu Label**
- ⑥ **Oven Air Vent** (Vent Grille/Vent Grille is removable and can be cleaned, see page 28)
- ⑦ **Control Panel**
- ⑧ **Door Release Button**  
Press to open the door.  
Opening the door during cooking will stop the cooking process without canceling program. Cooking resumes as soon as the door is closed and Start Pad is pressed. The oven light will stay on or turn on whenever the door is opened.
- ⑨ **Cooktop Light** (Cooktop Light can be replaced, see page 29)
- ⑩ **Grease Filter** (Grease filter is removable and can be cleaned, see page 28)
- ⑪ **Shelf Supports** (NN-S262 only)
- ⑫ **Door Safety Lock System**
- ⑬ **Identification Plate**

# CONTROL PANEL (NN-S262)

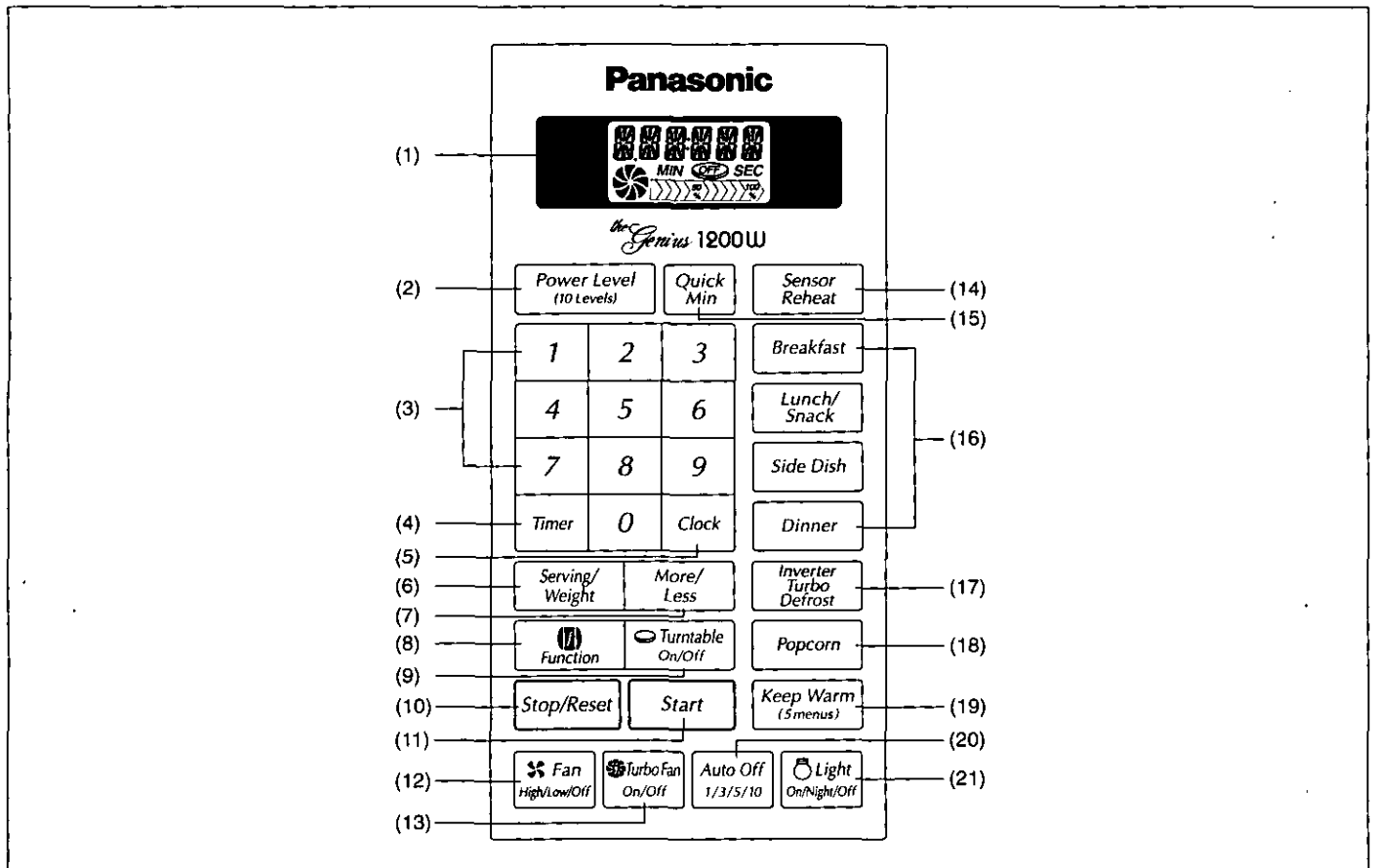

- (1) **Display Window:** The Display includes a clock and indicators to tell you time of day, cooking time settings and cooking functions selected.
- (2) **Power Level Pad:** Touch this pad to select a cooking power level. (☛page 14)
- (3) **Number Pads:** Touch number pads to enter cooking time, power level, quantities or weights.
- (4) **Timer Pad:** Touch this pad to set the kitchen timer. (☛page 22)
- (5) **Clock Pad:** Touch this pad to enter the time of day. (☛page 13)
- (6) **Serving/Weight Pad:** Touch this pad to verify serving size when using "Keep Warm". (☛page 15)
- (7) **More/Less Pad:** Touch this pad to cook food for a longer or shorter time when using Popcorn, Sensor Reheat and Sensor Cooking pads. (☛page 14, 17)
- (8) **Function Pad :** Touch this pad to change the oven's default settings for sound, clock, display speed, defrost weight, and demo mode operations. (☛page 12)
- (9) **Turntable On/Off Pad:** Touch this pad to turn the Turntable on or off. (☛page 13)
- (10) **Stop/Reset Pad:** Touch this pad to stop oven or clear all entries.
- (11) **Start Pad:** Touch this pad to start a function. If you open the door after oven begins to cook, retouch START.
- (12) **Fan High/Low/Off Pad:** Touch this pad to turn the fan on or off. (☛page 13)
- (13) **Turbo Fan On/Off Pad:** Touch this pad to turn the Turbo Fan on or off. (☛page 13)
- (14) **Sensor Reheat Pad:** Touch this pad to reheat any quantity of food with only one touch. (☛page 17)
- (15) **Quick Min Pad:** Touch this pad to set and start quickly at P10 power level. (☛page 15)
- (16) **Sensor Cooking Pads (☛page 17)**
- (17) **Inverter Turbo Defrost Pad:** This feature allows you to defrost meat, poultry and seafood simply by entering the weight. (☛page 15)
- (18) **Popcorn Pad:** Touch this pad to pop packaged microwave popcorn. (☛page 14)
- (19) **Keep Warm Pad:** Touch this pad to keep a certain selection of foods warm for 30 minutes after cooking. (☛page 15)
- (20) **Auto Off 1/3/5/10 Pad:** Touch this pad to set the fan time. (☛page 13)
- (21) **Light On/Night/Off Pad:** Touch this pad to turn on the cooktop light. (☛page 13)

# CONTROL PANEL (NN-S252)

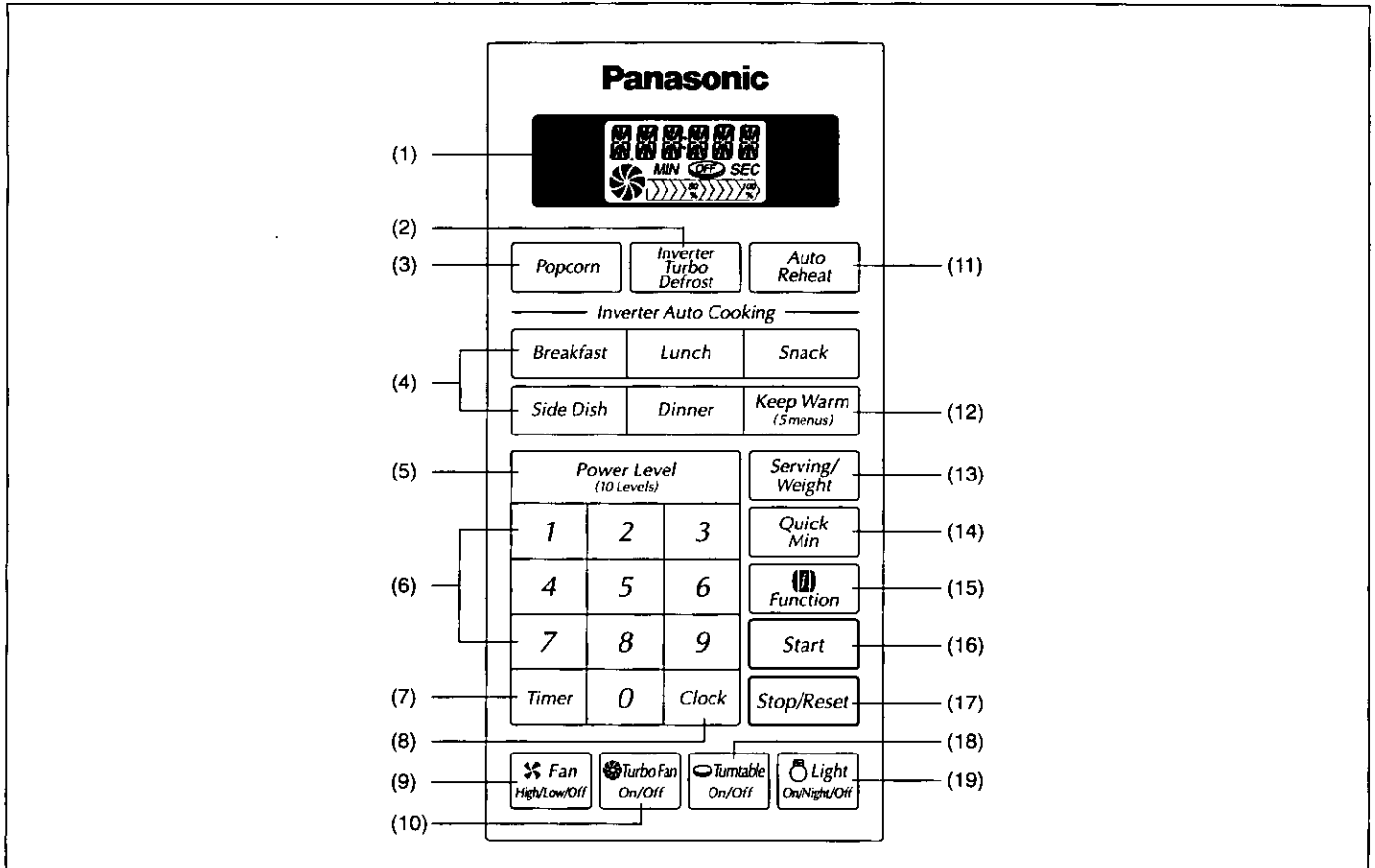



- (1) **Display Window:** The Display includes a clock and indicators to tell you time of day, cooking time settings and cooking functions selected.
- (2) **Inverter Turbo Defrost Pad:** This feature allows you to defrost meat, poultry and seafood simply by entering the weight. (☛page 15)
- (3) **Popcorn Pad:** Touch this pad to pop bags of packaged microwave popcorn. (☛page 14)
- (4) **Inverter Auto Cooking Pads** (☛page 20)
- (5) **Power Level Pad:** Touch this pad to select a cooking power level. (☛page 14)
- (6) **Number Pads:** Touch number pads to enter cooking time, power level, quantities or weights.
- (7) **Timer Pad:** Touch this pad to set the kitchen timer. (☛page 22)
- (8) **Clock Pad:** Touch this pad to enter the time of day. (☛page 13)
- (9) **Fan High/Low/Off Pad:** Touch this pad to turn the fan on or off. (☛page 13)
- (10) **Turbo Fan On/Off Pad:** Touch this pad to turn the Turbo Fan on or off. (☛page 13)
- (11) **Auto Reheat Pad:** Touch this pad to reheat a dinner plate, soup/sauce, or casserole. (☛page 20)
- (12) **Keep Warm Pad:** Touch this pad to keep a certain selection of foods warm for 30 minutes after cooking. (☛page 15)
- (13) **Serving/Weight Pad:** Touch this pad to verify serving size when using Keep Warm and Inverter Auto Cooking. (☛page 15, 20)
- (14) **Quick Min Pad:** Touch this pad to set and start quickly at P10 power level. (☛page 15)
- (15) **Function Pad :** Touch this pad to change the oven's default settings for sound, clock, display speed, defrost weight, and demo mode operations. (☛page 12)
- (16) **Start Pad:** Touch this pad to start a function. If you open the door after oven begins to cook, retouch START.
- (17) **Stop/Reset Pad:** Touch this pad to stop oven or clear all entries.
- (18) **Turntable On/Off Pad:** Touch this pad to turn the Turntable on or off. (☛page 13)
- (19) **Light On/Night/Off Pad:** Touch this pad to turn on the cooktop light. (☛page 13)

# OPERATION

## To Use Function Pad

This unique feature of your PANASONIC microwave oven allows you to establish the initial non-cooking features of your oven such as CHILD LOCK, WORD SPEED, LANGUAGE CHOICE (ENGLISH, FRENCH OR SPANISH), plus many more. See below.

1) 	Press: FUNCTION. Menu Action Message is "Select Function 0 through 9, 1--LANGUAGE CHOICE --- etc".
2) Select a number (0-9) e.g. CHILD LOCK is 5	Press 5: Menu Action Message is "CHILD LOCK ON/OFF".
3) Select <input type="text" value="1"/> , <input type="text" value="2"/> or <input type="text" value="3"/>	Press: One number. Your selection is now part of the operating system. You can change it any time.
4) Continue until you have completed your selections.	See below for other options.



 Function	<b>1</b>	<b>LANGUAGE CHOICE</b> The oven has English, French and Spanish display. The display appears in English when you plug-in. 1 ENGLISH → Display appears in English. 2 FRANCAIS → Display appears in French. 3 ESPANOL → Display appears in Spanish.
	<b>2</b>	<b>Lb/KG CHOICE</b> The oven has both Imperial and Metric weight measurements. The oven displays the weight in Imperial when you plug it in. 1 Lb → Weight can be set in oz/lb, (Imperial). 2 KG → Weight can be set in g/kg, (Metric).
	<b>3</b>	<b>WORD SPEED</b> The speed of word scrolling on the <i>Display Window</i> can be sped up or slowed down. 1 QUICK → Words scroll quickly. 2 MEDIUM → Scrolling speed returns to initial setting. 3 SLOW → Words scroll slowly.
	<b>4</b>	<b>MENU ACTION ON/OFF</b> MENU ACTION SCREEN helps you to program your oven by prompting the next step to be taken. When you become familiar with your oven, the prompting can be turned off. 1 ON → Prompting Guide will appear. 2 OFF → Prompting Guide will not appear.
	<b>5</b>	<b>CHILD LOCK ON/OFF</b> The oven has a Child Safety Lock feature which prevents use by children. It does not lock the door. 1 ON → Child Lock has been set and operation will not be accepted. 2 OFF → Child Lock has been cancelled.
	<b>6</b>	<b>BEEP ON/OFF</b> If you wish to have the oven operate with no beep, it can be eliminated. 1 ON → Beep sound will reactivate. 2 OFF → Beep sound will not be heard.
	<b>7</b>	<b>REMINDER BEEP ON/OFF</b> A reminder beep works to remind you to remove the food from the oven after the completion of cooking. It will occur every 15 seconds. 1 ON → Reminder beep will work. 2 OFF → Reminder beep will not work.
	<b>8</b>	<b>DAYLIGHT SAVING ON/OFF</b> 1 ON → Time of day will advance one hour. 2 OFF → Time of day returns to original setting.
	<b>9</b>	<b>CLOCK ON/OFF</b> Clock display can be turned off. 1 ON → Clock display will appear on the <i>Display Window</i> . 2 OFF → Clock display will not appear on the <i>Display Window</i> . Time of day will not be lost while the display is off.
	<b>0</b>	<b>DEMO MODE ON/OFF</b> Demo mode is designed for retail store display. In this mode, the oven can be demonstrated with no power in the oven. 1 ON → The oven is in Demo mode. 2 OFF → The oven is not in Demo mode.

# OPERATION

## Clock Setting

The oven will operate without setting the clock.

**Example: To set 11:25 a.m. or p.m.**

1.		<ul style="list-style-type: none"> <li>Press once.</li> <li>▶ Colon flashes.</li> </ul>				
2.	<table border="1" style="display: inline-table; border-collapse: collapse;"> <tr> <td style="width: 20px; text-align: center;">1</td> <td style="width: 20px; text-align: center;">:</td> <td style="width: 20px; text-align: center;">2</td> <td style="width: 20px; text-align: center;">5</td> </tr> </table>	1	:	2	5	<ul style="list-style-type: none"> <li>Enter time of day using the number pads.</li> <li>▶ Time appears on the <b>Display Window</b>, colon continues flashing.</li> </ul>
1	:	2	5			
3.		<ul style="list-style-type: none"> <li>Press once.</li> <li>▶ Colon stops flashing; time of day is entered.</li> </ul>				

### NOTES:

1. To reset the clock, repeat steps 1-3.
2. The clock will retain the time of day as long as the oven is plugged in and electricity is supplied.
3. Clock is a 12 hour display.
4. Oven will not operate while colon is flashing.

## Light On/Night/Off



This feature allows you to control the brightness of Cooktop Light. Press "Light On/Night/Off" pad once for bright light, twice for the night light or three times to turn the light off.

## Turntable On/Off



For best cooking results, leave the turntable on. It can be turned off for large dishes.

Press "Turntable On/Off" pad to turn the turntable on or off. When you turn it off,  will appear in the display window.

### Note:

When "Turntable OFF" is selected, it will automatically return to "ON" again after the heating cycle is completed. **Do not** operate the oven "Turntable Off" when cooking foods on Popcorn / Inverter Turbo Defrost / Keep Warm / Sensor Reheat / Sensor Cook / Auto Reheat / Inverter Auto Cooking.

**Sometimes the turntable can become too hot to touch.** Be careful when touching the turntable during and after cooking.

## Fan High/Low/Off



The Fan (Vent Fan) removes steam and other vapors from the cooking surface. Press "Fan High/Low/Off" pad once for High fan speed, twice for Low fan speed, or a three times to turn the fan off. When you turn it on,  will appear on the display window.

### NOTE: Automatic Fan

If the temperature gets too hot around the microwave oven, the fan in the vent hood will automatically turn on at the Turbo setting to cool the oven. When this occurs, the Display Window shows "VENTILATING" and **you cannot turn the fan off manually.** The fan will automatically turn off when the internal parts are cool. It may stay on for 30 minutes or more.

## Turbo Fan On/Off



Use "Turbo Fan On/Off" pad for maximum fan speed. Press "Turbo Fan On/Off" pad once to turn on the Turbo Fan or twice to turn it off. When you turn it on,  will appear on the display window.

## Auto Off 1/3/5/10 (NN-S262)



Press "Auto Off 1/3/5/10" pad to set fan time. After you have selected Fan High/Low or Turbo Fan On, you can set the desired time that automatically turns off the Fan or Turbo Fan. The following is the set times for the number of taps to the key:

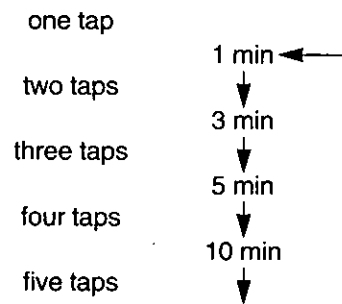

NOTE: If Auto Off is retouched while Auto Off time had been set, you must reset the time.

**When "HOT" appears on the Display Window;** When using range below on high heating power or using electric oven for a long time, "HOT" appears on the Display Window and the microwave oven does not work. In this case, wait until the microwave oven is cool and "HOT" disappears.



Using "Turbo Fan On" makes the oven cool rapidly.

# OPERATION

## Power & Time Setting

How do I program Power and Time?

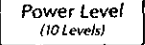
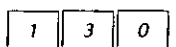
**Example: To cook at P 6 (MEDIUM) Power for 1 minute 30 seconds**

1.  Press 5 times	• Select <b>Power Level</b> . (according to the chart below)
2. 	• Set Cooking Time using number pads.
3. 	• Press. ▶Cooking will start. The time on the <b>Display Window</b> will count down.



Press	Power Level
once	P10 (HIGH)
twice	P 9
3 times	P 8
4 times	P 7 (MEDIUM-HIGH)
5 times	P 6 (MEDIUM)
6 times	P 5
7 times	P 4
8 times	P 3 (MEDIUM-LOW)/DEFROST
9 times	P 2
10 times	P 1 (LOW)

### NOTES:

- For more than one stage cooking, repeat steps 1 and 2 for each stage of cooking before pressing **Start** Pad. The maximum number of stages for cooking is 5 stages.
- When selecting P10 (HIGH) power for the first stage, you may begin at step 2.
- Two beeps will sound between each stage of programming. Five beeps will sound at the end of the entire sequence.
- When selecting P10 (HIGH) power, the maximum programmable time is 30 minutes. For other power levels, the maximum time is 99 minutes and 99 seconds.
- For reheating, use P10 (HIGH) for liquids, P7 (MEDIUM-HIGH) for most foods and P6 (MEDIUM) for dense foods.
- For defrosting, use P3 (MEDIUM-LOW).

## To Use Popcorn Pad

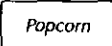
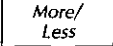
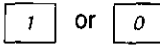
**Example: To heat 3.5 oz. of Popcorn**

1.  Press once.	• Set the desired weight of prepackaged microwave popcorn. <table border="1"> <thead> <tr> <th>Press</th> <th>Weight</th> </tr> </thead> <tbody> <tr> <td>once</td> <td>3.5 oz. (99g)</td> </tr> <tr> <td>twice</td> <td>3.0 oz. (85g)</td> </tr> <tr> <td>3 times</td> <td>2.85 oz. (80g)</td> </tr> <tr> <td>4 times</td> <td>2.65 oz. (75g)</td> </tr> <tr> <td>5 times</td> <td>1.75 oz. (50g)</td> </tr> </tbody> </table>	Press	Weight	once	3.5 oz. (99g)	twice	3.0 oz. (85g)	3 times	2.85 oz. (80g)	4 times	2.65 oz. (75g)	5 times	1.75 oz. (50g)
Press	Weight												
once	3.5 oz. (99g)												
twice	3.0 oz. (85g)												
3 times	2.85 oz. (80g)												
4 times	2.65 oz. (75g)												
5 times	1.75 oz. (50g)												
2. More/Less Control (Optional) NN-S262  NN-S252 													
3. 	• Press <b>Start</b> Pad. ▶After several seconds, cooking time appears on the <b>Display Window</b> and begins to count down.												

### To Use More/Less Control Function:

When using Popcorn pad, the weight may not be the same as offered.



#### NN-S262



By using the More/Less pad, the programs can be adjusted to cook food for a longer or shorter time or for a heavier or lighter weight.



- 1 tap = More<sup>+</sup> Cooking
- 2 taps = More<sup>++</sup> Cooking
- 3 taps = Less<sup>-</sup> Cooking
- 4 taps = Less<sup>--</sup> Cooking
- 5 taps = original setting



Press More/Less pad before pressing Start.



#### NN-S252

By using the number pad  or , the programs can be adjusted to cook for a heavier or lighter weight.

To control by  or  pad:

-  1 tap = More<sup>+</sup>
- Press  2 taps = More<sup>++</sup>

-  1 tap = Less<sup>-</sup>
- Press  2 taps = Less<sup>--</sup>

Press  or  pads before pressing Start.

### NOTES ON POPCORN PAD:

- Use prepackaged room temperature microwave popcorn. Read manufacturers' instructions.
- Place bag in oven according to manufacturers' directions.
- Pop only one bag at a time.
- After popping, allow the contents of the bag to cool for a few minutes before opening. Open bag carefully away from face and body because popcorn and steam are extremely hot.
- Do not reheat unpopped kernels or reuse bag.
- NEVER leave oven unattended when popping popcorn. Stop the oven when popping slows to 2 to 3 seconds between pops. Overcooking may cause scorching.
- With the many varieties of microwave popcorn available on the market, it may be necessary for you to move the popcorn container to the outer edge of the Glass Tray to obtain the best cooking results.

### REMARKS:

When popping multiple bags one right after the other, the cooking times may vary slightly. This does not affect the popcorn results.



# OPERATION

## Quick Min Function

This feature allows you to set and/or add cooking times easily in multiples of one minute.

### To Set Cooking Time:

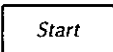
1.		• Set cooking time (up to 10 minutes). Power Level is P10.
2.		• Press <b>Start</b> Pad. ➤Cooking begins and <b>Display Window</b> counts down. At the end of cooking, 5 beeps sound and color or time of day appears.

### NOTE:

1. You can use other power levels. Select desired power level before setting cooking time.
2. After setting the time by **Quick Min** Pad, you cannot use Number Pads, and vice versa.
3. Press **Quick Min** Pad to add more time during cooking. To verify the additional cooking time, check the **Display Window**.

## To Use Keep Warm Pad

This feature helps you to keep a certain selection of foods warm for 30 minutes after cooking. (Pie, Gravy, Stew, Casserole or Mashed Potatoes)

### Example: To keep 2 cups of Gravy warm.

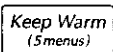
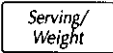
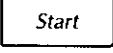
1.	 Press twice.	• Select the desired category.
2.	 Press twice.	• Verify serving size on the <b>Display Window</b> .
3.		• Press. ➤Keep Warm will start. The time on the <b>Display Window</b> will count down from 30 minutes.



## Inverter Turbo Defrost

This feature allows you to defrost meat, poultry and seafood simply by entering the weight.

### Example: To defrost 1.5 pounds of meat.

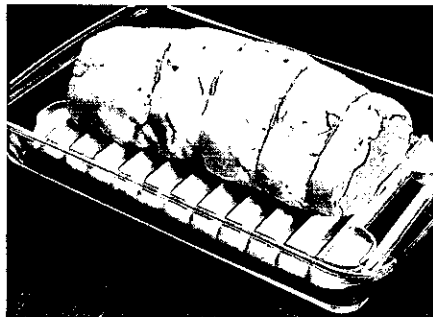
Place food on microwave safe roasting rack in an appropriately sized dish.



1.		• Press. "INVERTER TURBO DEFROST" appears briefly on the <b>Display Window</b> .
2.		• Enter weight of the food using the number pads.
3.		• Press. ➤Defrosting will start. The time on the <b>Display Window</b> will count down. Halfway through defrosting, beep sounds. Turn over, rearrange foods, remove defrost areas or shield with aluminum foil. (See directions "DURING DEFROSTING" in page 16.)

### Conversion Chart:

Follow the chart to convert ounces or hundredths of a pound into tenths of a pound. To use Inverter Turbo Defrost, program the weight of the food in lbs. (1.0) and tenths of a lb. (0.1). If a piece of meat weighs 1.95 lbs. or 1 lb. 14 oz., program 1.9 lbs.

Ounces	Hundredths of a Pound	Tenths of a Pound
0	.01 - .05	0.0
1 - 2	.06 - .15	0.1
3 - 4	.16 - .25	0.2
5	.26 - .35	0.3
6 - 7	.36 - .45	0.4
8	.46 - .55	0.5
9 - 10	.56 - .65	0.6
11 - 12	.66 - .75	0.7
13	.76 - .85	0.8
14 - 15	.86 - .95	0.9

# Defrosting Tips & Techniques

## **Before Freezing:**

1. Freeze meats, poultry and fish in packages with only 1 or 2 layers of food.  
Place wax paper between layers.
2. Package in heavy-duty plastic wraps, bags (labeled "For Freezer") or freezer paper.
3. Remove as much air as possible, i.e. create a vacuum.
4. Seal securely, date and label.

## **To Defrost:**

1. Remove wrapper. This helps moisture to evaporate.  
Juices from food can get hot and cook the food.
2. Set food on microwave safe roasting rack in an appropriately sized dish.
3. Place roasts fat-side down. Place whole poultry breast-side down.
4. Drain liquids during defrosting.
5. Turn over (invert) items during defrosting.
6. Shield edges and ends if needed. (See **Cooking Techniques**).
7. Select power and minimum time so that items will be under-defrosted.

## **After Defrosting:**

1. Large items may be icy in the center. Defrosting will complete during STANDING TIME.
2. Let stand, covered with plastic wrap, in the refrigerator for time shown in the chart below.
3. See chart below for standing time and rinsing directions.
4. Items which have been layered should be rinsed separately or have a longer stand time.



FOOD	DEFROST TIME (min. per pound) (P 3)	DURING DEFROSTING	AFTER DEFROSTING	
			Stand Time	Rinse (cold water)
<b>Fish and Seafood</b> [up to 3 lbs. (1.4 kg)]				
Crabmeat	6	Break apart/Rearrange	5 min.	YES
Fish Steaks	4 to 6	Turn over		
Fish Fillets	4 to 6	Turn over/Rearrange/Shield ends		
Sea Scallops	4 to 6	Break apart/Remove defrosted pieces		
Whole fish	4 to 6	Turn over		
<b>Meat</b>				
Ground Meat	4 to 5	Turn over/Remove defrosted portion/Shield edges	10 min.	NO
Roasts [2½ - 4 lbs. (1.1-1.8 kg)]	4 to 8	Turn over/Shield ends and defrosted surface	30 min. in refrig	
Chops/Steak	6 to 8	Turn over/Rearrange/Shield ends and defrosted surface	5 min.	
Ribs/T-bone	6 to 8	Turn over/Rearrange/Shield ends and defrosted surface		
Stew Meat	4 to 8	Break apart/Rearrange/Remove defrosted pieces		
Liver (thin sliced)	4 to 6	Drain liquid/Turn over/Separate pieces		
Bacon (sliced)	4	Turn over	---	
<b>Poultry</b>				
Chicken, Whole [up to 3 lbs. (1.4 kg)]	4 to 6	Turn over/Shield	20 min. in refrig.	YES
Cutlets	4 to 6	Break apart/Turn over/Remove defrosted pieces	5 min.	
Pieces	4 to 6	Break apart/Turn over/Shield	10 min.	
Cornish Hens	6 to 8	Turn over/Shield	20 min. in refrig	
Turkey Breast [5 - 6 lbs. (2.3 - 2.7 kg)]	6	Turn over/Shield		

# OPERATION

## Sensor Reheat (NN-S262)

This sensor feature allows you to reheat any quantity of food with only one touch. The oven does it all for you.

### Example: To reheat 2 cups of soup

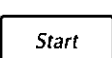
1.		• Press.
2.	 Optional.	
3.		• Press. ➤Cooking starts.

After heat/steam is detected by the **Genius**, 2 beeps sound.  
The remaining cooking time appears on the **Display Window** and begins to count down.  
At the end of cooking, five beeps sound.

#### NOTES:

**Casseroles** - Add 3 to 4 tablespoons of liquid; cover with lid or vented plastic wrap. Stir when time appears on the **Display Window**.

**Canned foods** - Empty contents into casserole dish or serving bowl; cover dish with lid or vented plastic wrap. After reheating, release plastic wrap and stand.

**Plate of food** - Arrange food on plate; top with butter, gravy, etc.. After reheating, release plastic wrap and stand.

Follow the recommendations for Sensor Cooking, in addition to the following:

#### DO NOT:

1. Reheat bread and pastry products. Use manual power and time for these foods.
2. Reheat raw or uncooked food.
3. Use if oven cavity is warm.
4. Use for beverages.
5. Use for frozen foods.

**For the best results with the GENIUS, follow these recommendations.**

#### BEFORE Reheating/Cooking

1. The room temperature surrounding the oven should be below 95° F (35° C).
2. Food weight should exceed 4 oz. (110 g).
3. Glass Tray and outside of container should be dry.
4. Cover food loosely with lid, or with vented plastic wrap.
5. All foods should be taken from their normal storage place.

The microwave oven needs to be plugged into the proper outlet for at least 2 minutes in order for the Sensor Reheat / Cook functions to work properly.

## Sensor Cook (NN-S262)

Breakfast, Lunch/Snack, Side Dish, Dinner

This sensor feature allows you to cook any quantity of food with only one touch. The oven does it all for you.

### Example: To cook a 10 oz. Frozen Entrée.

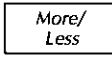
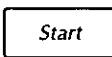
1.	 Press twice.	• Press until the desired category appears on the <b>Display Window</b> .
2.	 Optional.	
3.		• Press. ➤Cooking starts.

After heat/steam is detected by the **Genius**, 2 beeps sound.  
The remaining cooking time appears on the **Display Window** and begins to count down.  
At the end of cooking, five beeps sound.

#### To Use More/Less Control Function:

Preferences for food doneness vary with each individual. After having used the Sensor Cook feature a few times, you may decide you would prefer your food cooked to a different doneness.

- 1 tap = More<sup>+</sup> Cooking
- 2 taps = Less<sup>-</sup> Cooking
- 3 taps = original setting

Press More/Less pad before pressing Start.

#### DURING Reheating/Cooking:

DO NOT open the oven door until 2 beeps sound and time appears on the **Display Window**. Doing so will cause inaccurate cooking since the steam from food is no longer contained within the oven cavity. Once the timer begins to count down, the oven door may be opened to stir, turn, shield, rearrange, mix or add foods.

#### AFTER Reheating/Cooking:

All foods should have a covered stand time.  
If additional time is needed, continue to cook manually.

# Sensor Cook Chart (NN-S262)

Pad	Recipe	Serving/Weight	HINTS
<b>Breakfast</b>	<b>1. Oatmeal</b>	½, 1 cup (125, 250 mL)	Place inside a microwave-safe serving bowl with no cover. Follow manufacturers' directions for preparation of quick oatmeal.
	<b>2. Breakfast Sausage</b>	8 maximum	Follow manufacturers' directions for preparation of pre-cooked breakfast sausage. Place in a radial pattern.
	<b>3. Omelet</b>		2, 4 eggs Follow Basic Omelet recipe on page 19.
<b>Lunch/Snack</b>	<b>1. Soup</b>	1 - 2 cups (250 - 500 mL)	Pour soup into a microwave-safe serving bowl. Cover loosely with lid or vented plastic wrap.
	<b>2. Frozen Entrées</b>	8 - 32 oz. (225 - 900 g)	Follow manufacturers' directions for preparation of 8 and 10 oz. sizes. For larger sized entrées, where the directions state for the entire film cover to be removed, do not vent or remove film cover to ensure the sensor will detect accurately for complete cooking. Be careful when removing the film cover after cooking. Remove them away from you to avoid steam burns. *If additional time is needed, continue to cook manually.*
	<b>3. Frozen Pizza (single)</b>	4, 8 oz. (110, 225 g)	Follow manufacturers' directions for preparation.
	<b>4. Hot Dog</b>	4 maximum	Make 3 slits on each Hot Dog. Place Hot Dog on paper plate or microwave-safe dish leaving space between each. Times may vary by size and manufacturer. *If additional time is needed, continue to cook manually.*
<b>Side Dish</b>	<b>1. Potatoes</b>	4 maximum (6 - 8 oz. each) (170 - 225 g)	Pierce at least 6 times on top of each potato with a fork. Place potato or potatoes around the edge of paper-towel-lined Glass Tray (Turntable), at least 1 inch (2.5 cm) apart. Do not cover. Let stand 5 minutes to complete cooking.
	<b>2. Rice</b>	½ - 1½ cups (125 - 375 mL)	Place rice with hot water in a microwave-safe casserole dish. Cover loosely with lid or vented plastic wrap. Let stand 5 to 10 minutes before serving.
	<b>3. Fresh Vegetables</b>	¼ - 1 lb. (110 - 450 g)	All pieces should be the same size. Add a small amount of water and cover loosely with lid or vented plastic wrap.
	<b>4. Canned Vegetables</b>	15 oz. (430 g)	Empty contents into microwave-safe serving bowl. Cover loosely with lid or vented plastic wrap. *If additional time is needed, continue to cook manually.*
	<b>5. Frozen Vegetables</b>	6 - 16 oz. (170 - 450 g)	Follow manufacturers' directions. Do not salt until after cooking. (Not suitable for vegetables in butter or sauce.) After 2 beeps, stir or rearrange.
<b>Dinner</b>	<b>1. Frozen Dinners</b>	11, 15 oz. (300, 430 g)	Follow manufacturers' directions for covering or removing covers. For best results, do not use frozen foods packaged in foil tray.
	<b>2. Chicken Pieces</b>	½ - 2 lb. (170 - 900 g)	Place skin-side up. Cover with vented plastic wrap. Let stand 5 minutes before serving.
	<b>3. Ground Meat</b>	1 - 2 lb. (16 - 32 oz.) (450 - 900 g)	Break apart in glass bowl or colander. Cover with vented plastic wrap. After 2 beeps, stir. Re-cover and press <b>Start</b> . Juices should be clear. Drain.
	<b>4. Fish Fillets</b>	¼ - 1 lb. (110 - 450 g)	Arrange in a single layer. Cover with vented plastic wrap.
	<b>5. Pasta</b>	2 - 8 oz. (57 - 225 g)	Place pasta with hot water in a microwave-safe casserole dish. Cover loosely with lid or plastic wrap. Drain.
	<b>6. Casserole</b>	-----	Prepare according to recipes found on page 19. *If additional time is needed, continue to cook manually.*

# Sensor Cook Recipe (NN-S262)

## OMELET

### *Basic Omelet*

- 1 tablespoon butter or margarine
- 2 eggs
- 2 tablespoons milk
- salt and ground black pepper, if desired

Heat butter in a 9-inch pie plate, 30 seconds at P10, or until melted, turn the plate to coat the bottom with butter. Meanwhile, combine the remaining ingredients in a separate bowl and beat together; pour into the pie plate. Cook, covered with vented plastic wrap, on OMELET. Let stand 2 minutes. With a spatula, loosen the edges of the omelet from the plate; fold into thirds to serve.

**Yield:** 1 serving

**Approx. cooking time:** 4 minutes.

**NOTE:** Double ingredients for a 4 egg Omelet.

## CASSEROLE

### *Shepherd's Pie*

- 1 pound lean ground beef
- 1/2 cup frozen peas, thawed
- 1/4 cup chopped onion
- 1 tablespoon gravy powder
- 1/2 teaspoon curry powder
- 1/4 teaspoon salt
- 1/4 teaspoon ground black pepper
- 2 cups mashed potatoes

In a 2-Qt. casserole dish, crumble the beef and cook for 8 - 10 minutes at P6, until the meat is cooked; stirring twice. Add the remaining ingredients, except the potatoes. Stir well and spread the potatoes evenly on the top. Cover with a lid and cook on CASSEROLE.

**Yield:** 4 servings

**Approx. cooking time:** 20 minutes

### *Macaroni and Cheese*

- 1/4 cup butter
- 2 tablespoons chopped onion
- 1 clove minced garlic
- 1/4 cup all-purpose flour
- 1 teaspoon dry mustard
- 1 teaspoon salt
- 1/4 teaspoon ground black pepper
- 2 cups milk
- 2 cups grated cheddar cheese
- 8 oz. (1/2 lb dry weight) macaroni, cooked and drained
- 1/3 cup bread crumbs
- 1 teaspoon paprika

In a 2-Qt. casserole, melt the butter for 40 seconds at P10. Add onion and garlic and cook for 1 minute at P10. Stir in flour, mustard, salt and pepper then, gradually add the milk. Cook for 3 - 4 minutes at P10, stirring once. Continue cooking for 3 - 4 minutes at P10 or until sauce thickens. Stir in the cheddar cheese. Stir the sauce into the macaroni, in a 3-Qt. casserole. Top with bread crumbs and paprika. Cover with vented plastic wrap. Cook on CASSEROLE.

**Yield:** 6 servings

**Approx. cooking time:** 20 minutes

### *Beef and Macaroni Casserole*

- 1 pound lean ground beef
- 1 small chopped onion
- 1/2 green bell pepper, chopped
- 1 cup chopped celery
- 2 cans (15 oz.) tomato sauce
- 1 1/4 cups water
- 1 cup uncooked elbow macaroni
- 1 teaspoon parsley
- 1/2 teaspoon salt
- 1/4 teaspoon ground black pepper
- 1/2 cup grated cheddar cheese

Crumble the ground beef in a 3-Qt. casserole. Cook for 8 - 10 minutes at P6 or until the meat is cooked; stirring twice. Add onion, peppers and celery. Cook for 3 - 4 minutes at P10. Add the remaining ingredients, except cheese. Cover with vented plastic wrap. Cook on CASSEROLE. Sprinkle with cheese. Cover and let stand 5 minutes.

**Yield:** 4-6 servings

**Approx. cooking time:** 20 minutes

### *Tuna Casserole*

- 1 can (6 oz.) drained and flaked tuna
- 4 cups cooked and drained noodles
- 1 can (10 3/4 oz.) condensed cream of mushroom soup
- 1 can (4 oz.) mushroom pieces and stems, drained
- 1 package (16 oz.) frozen peas, defrosted
- 3/4 cup milk
- 1 cup crushed potato chips
- 1/2 cup grated cheddar cheese

In a 3-Qt. casserole, combine tuna, noodles, soup, mushrooms, peas and milk; mix well. Cover with vented plastic wrap. Cook on CASSEROLE. Top with potato chips and cheese.

**Yield:** 4-6 servings

**Approx. cooking time:** 20 minutes

# OPERATION

## Auto Reheat (NN-S252)

This feature allows you to reheat 1 to 4 servings of precooked room temperature and refrigerator temperature foods without setting power and time.

### Example: To reheat 2 cups of soup

1.	<div style="border: 1px solid black; padding: 2px; width: fit-content; margin: 0 auto;">Auto Reheat</div>	<ul style="list-style-type: none"> <li>• Press until the desired number of servings appears on the <b>Display Window</b>.</li> </ul>
	Press twice.	
2.	<div style="border: 1px solid black; padding: 2px; width: fit-content; margin: 0 auto;">Start</div>	<ul style="list-style-type: none"> <li>• Press.                             <ul style="list-style-type: none"> <li>▶ Cooking time appears on the <b>Display Window</b> and begins to count down.</li> </ul> </li> </ul>

Press Auto Reheat pad to indicate number or servings	Average Serving Size
once	4-6 oz.
twice	8 oz.
three times	12 oz.
four times	16 oz.

**NOTES:** For best results, follow these recommendations:

1. All foods must be previously cooked.
2. Foods should always be covered loosely with plastic wrap, wax paper or casserole lid.
3. All foods should have a covered stand time of 3 to 5 minutes.
4. **DO NOT** reheat bread and pastry products using **Auto Reheat**. Use manual power and time instead.
5. **DO NOT** reheat beverages.
6. Times are based on an approximate serving size of 4 oz.
7. A plate of food is normally 3-4 servings.

## Inverter Auto Cooking (NN-S252)

### Example: To cook a 10 oz. Frozen Entrée

1.	<div style="border: 1px solid black; padding: 2px; width: fit-content; margin: 0 auto;">Lunch</div>	<ul style="list-style-type: none"> <li>• Press until the desired category appears on the <b>Display Window</b>.</li> </ul>
	Press 3 times.	
2.	<div style="border: 1px solid black; padding: 2px; width: fit-content; margin: 0 auto;">Serving/Weight</div>	<ul style="list-style-type: none"> <li>• Press.                             <ul style="list-style-type: none"> <li>▶ Verify Serving/Weight on the <b>Display Window</b>.</li> </ul> </li> </ul>
	Press twice.	
3.	<div style="border: 1px solid black; padding: 2px; width: fit-content; margin: 0 auto;">Start</div>	<ul style="list-style-type: none"> <li>• Press.                             <ul style="list-style-type: none"> <li>▶ Cooking time appears on the <b>Display Window</b> and begins to count down.</li> </ul> </li> </ul>

## Inverter Auto Cooking Chart (NN-S252)

These foods are tested and pre-timed (based on the power rating of this oven) for the quantity of food listed in the chart below. Local, power fluctuations and personal tastes are not taken into account. Should you prefer your food cooked differently, use power and time method shown on page 14.

MEAL	FOOD	SERVING/WEIGHT	HINTS
<b>Breakfast</b>	<b>1. Oatmeal</b>	½, 1 cup (125, 250 mL)	Place inside a microwave-safe serving bowl with no cover. Follow manufacturers' directions for preparation of quick oatmeal.
	<b>2. Beverages</b>	1, 2 cups (250, 500 mL)	Use a microwave-safe coffee cup. Heated liquids can erupt if not mixed with air. Do not heat liquids in your microwave oven without stirring first before and after heating.
	<b>3. Bacon</b>	4 slices (3.2-4 oz.) (90-110 g) 6 slices (4.8-5.8 oz.) (135-165 g) 10 slices (8.1-9.5 oz.) (230-270 g) 14 slices (11.6-13 oz.) (330-370 g)	Place slices of bacon on a microwave-safe dish. Cover with paper towel. Times may vary by brand (weight). If bacon is not cooked to your liking, continue to heat by manually adding more time.
<b>Lunch</b>	<b>1. Soup</b>	1, 2 cups (250, 500 mL)	Pour soup into a microwave-safe serving bowl. Cover loosely with lid or vented plastic wrap.
	<b>2. Frozen Pizza (single)</b>	4, 8 oz. (110, 225 g)	Follow manufacturers' directions for preparation.
	<b>3. Frozen Entrées</b>	8, 10, 20, 32 oz. (225, 300, 600, 900 g)	Follow manufacturers' directions for covering or removing covers. For best results, do not use frozen foods packaged in foil tray.
<b>Snack</b>	<b>1. Hot Dog</b>	1, 2, 3, 4 pieces	Make 3 slits in each hot dog. Place hot dog on paper plate or microwave-safe dish leaving space between each. Times may vary by size and manufacturer.
<b>Side Dish</b>	<b>1. Potatoes</b>	1, 2, 3, 4 pieces (6 to 8 oz. each) (170-225 g)	Pierce at least 6 times on top of each potato with a fork. Place potato or potatoes around the edge of paper-towel-lined Glass Tray (Turntable), at least 1 inch (2.5 cm) apart. Do not cover. Let stand 5 minutes to complete cooking.
	<b>2. Rice</b>	½, 1, 1½ cups (125, 250, 375 mL)	Place rice with hot water in a microwave-safe casserole dish. Cover loosely with lid or vented plastic wrap. Let stand 5 to 10 minutes before serving.
	<b>3. Fresh Vegetables</b>	4, 8, 12, 16 oz. (110, 225, 340, 450 g)	All pieces should be the same size. Add a small amount of water and cover loosely with lid or vented plastic wrap.
	<b>4. Frozen Vegetables</b>	6, 10, 16 oz. (170, 300, 450 g)	Follow manufacturers' directions. Do not salt until after cooking. Not suitable for vegetables in butter or sauce.
<b>Dinner</b>	<b>1. Chicken Pieces</b>	6, 12, 18, 24 oz. (170, 340, 500, 680 g)	Place skin side up. Cover with vented plastic wrap. Let stand 5 minutes before serving.
	<b>2. Ground Meat</b>	16, 32 oz. (450, 900 g)	Break apart in glass bowl or colander. Cover with vented plastic wrap. After 2 beeps, stir. Recover and press <b>Start</b> . Juices should be clear. Drain.
	<b>3. Fish Fillets</b>	4, 8, 12, 16 oz. (110, 225, 340, 450 g)	Arrange in a single layer. Cover with vented plastic wrap.

# OPERATION

## Timer Setting

This feature allows you to program a Standing Time after cooking is completed and to program the oven as a kitchen timer and/or to program a delay start.



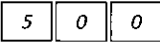
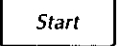

### To Use as a Kitchen Timer:

**Example: To count 5 minutes**

1.		• Press.
2.		• Set desired amount of time using number pads. (up to 99 minutes and 99 seconds).
3.		• Press. ▶ Time will count down without oven operating.

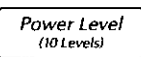
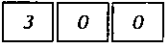
### To Set Stand Time:

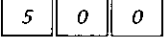
**Example: To stand for 5 mins. after cooking (3 mins. at P6 Power)**

1.	 5 times. ↓ 	• Enter the desired cooking program (see page 14 for directions).
2.		• Press once.
3.		• Set desired amount of Stand Time using number pads. (up to 99 minutes and 99 seconds)
4.		• Press. ▶ Cooking will start. After cooking, stand time will count down without oven operating.

### To Set Delay Start:

**Example: To start cooking 5 minutes later. (3 mins. at P6 Power).**

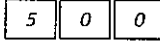
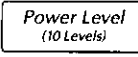
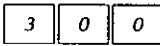
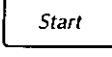
1.		• Press once.
2.		• Enter desired amount of delayed time using number pads. (up to 99 minutes and 99 seconds)
3.	 5 times. ↓ 	• Enter the desired cooking program (see page 14 for directions).
4.		• Press. ▶ Delayed time will count down. Then cooking will start.

### NOTES:

- When each stage finishes, a two-beep signal sounds. At the end of the program, the oven will beep five times.
- If oven door is opened during Stand Time or Kitchen Timer, the time on the **Display Window** will continue to count down.
- Stand time and Delay time cannot be programmed before any Auto Control Function. This is to prevent the starting temperature of food from rising before defrosting or cooking begins. A change in starting temperature could cause inaccurate results.



# OPERATION

## How to Use the Shelf When Microwaving (only for NN-S262)

1. The shelf must be positioned on Shelf Supports securely to prevent damage to the oven from arcing.
2. **DO NOT** use a microwave browning dish on the shelf. The shelf could overheat.
3. **DO NOT** use the oven with the shelf on the microwave floor. This could damage the microwave.
4. Use pot holders when handling the shelf—it may be hot.

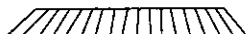

### Caution:

Do not heat liquids on shelf, use the turntable for heating liquids.

Also be careful when removing hot items from the shelf or turntable.

## For best cooking results

### 1-Level cooking

Food microwaves best when placed onto the turntable, with turntable on (rotating).

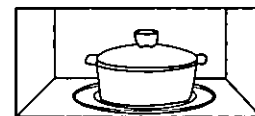

(Turntable On)  
For best results

When a large dish or more than one dish is used for cooking, the turntable can be turned off. In these cases, either rotate large dish, or switch places of multiple dishes halfway through cooking.

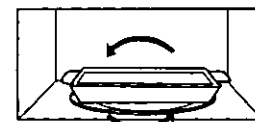

(Turntable Off)  
Rotate dish  
halfway through cooking

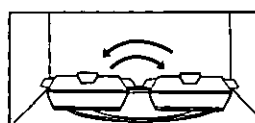

(Turntable Off)  
Switch places  
halfway through cooking

For best cooking results, remove the shelf unless you are reheating on more than one level.

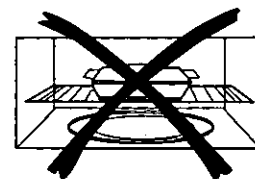

Uneven results

### 2-Level cooking

1. Multiply reheat time by 1½.
2. Switch places halfway through cooking.

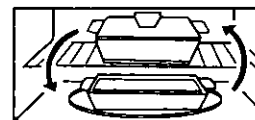

Switch places  
halfway through cooking

**DO NOT** use the shelf or operate Turntable Off when cooking foods on Popcorn / Inverter Turbo Defrost / Keep Warm / Sensor Reheat / Sensor Cook / Auto Reheat / Inverter Auto Cooking.

## Microwave Shortcuts

FOOD	POWER	TIME (in minutes)	DIRECTIONS
To separate <b>Bacon</b> , 1 pound (450 g)	<b>P10 (HIGH)</b>	30 sec.	Remove wrapper and place in a microwave-safe dish. After heating, use a plastic spatula to separate slices.
To soften <b>Brown Sugar</b> 1 cup (250 mL)	<b>P10 (HIGH)</b>	20 - 30 sec.	Place brown sugar in microwave-safe dish with a slice of bread. Cover with plastic wrap.
To soften <b>Butter</b> , 1 stick, ¼ pound (110 g) To melt <b>Butter</b> , 1 stick, ¼ pound (110 g)	<b>P3 (MEDIUM-LOW)</b>  <b>P6 (MEDIUM)</b>	1  1½ - 2	Remove wrapper and place butter in a microwave-safe dish. Remove wrapper and place butter in a microwave-safe dish covered with plastic wrap.
To melt <b>Chocolate</b> , 1 square, 1 oz. (28 g) To melt <b>Chocolate</b> , ½ cup (125 mL) chips	<b>P10 (HIGH)</b>  <b>P10 (HIGH)</b>	1 - 1½  1 - 1½	Remove wrapper and place chocolate in a microwave-safe dish. Stir before adding more time. (Stir until completely melted.) <i>Note: Chocolate holds its shape even when softened.</i>
To toast <b>Coconut</b> , ½ cup (125 mL)	<b>P10 (HIGH)</b>	1	Place in a microwave-safe dish. Stir every 30 seconds.
To soften <b>Cream Cheese</b> , 8 oz. (250 g)	<b>P3 (MEDIUM-LOW)</b>	1 - 2	Remove wrapper and place in a microwave-safe bowl.
To brown <b>Ground Beef</b> , 1 pound (450 g)	<b>P10 (HIGH)</b>	4 - 5	Crumble into a microwave-safe colander set into another dish. Stir twice. Drain grease.
To steam <b>Hand Towels</b> - 4	<b>P10 (HIGH)</b>	20 - 30 sec.	Soak in water, then wring out excess. Place on a microwave-safe dish. Heat. Present immediately.
To soften <b>Ice Cream</b> , ½ gallon (2 L)	<b>P3 (MEDIUM-LOW)</b>	1 - 1½	Check often to prevent melting.
Cup of liquid <b>boiling water, broth, etc.</b> 1 cup, 8 oz. (250 mL) 2 cups, 16 oz. (500 mL) to heat <b>milk</b> 1 cup, 8 oz. (250 mL) 2 cups, 16 oz. (500 mL)	<b>P10 (HIGH)</b>  <b>P7 (MEDIUM - HIGH)</b>	2½ - 3 4  2 - 3 4 - 5	Heated liquids can erupt if not stirred. Do not heat liquids in your microwave oven without stirring before and after heating.
To roast <b>Nuts</b> , 1½ cups (375 mL)	<b>P10 (HIGH)</b>	4 - 5	Spread nuts into a 9-inch (230 mm) microwave-safe pie plate. Stir occasionally.
To toast <b>Sesame Seeds</b> , ¼ cup (50 mL)	<b>P10 (HIGH)</b>	3 - 5	Place in a small microwave-safe bowl. Stir twice.
To skin <b>Tomatoes</b> (one at a time)	<b>P10 (HIGH)</b>	30 sec.	Place tomato into a microwave-safe bowl containing boiling water. Rinse and peel. Repeat for each tomato.
To remove <b>Cooking Odors</b>	<b>P10 (HIGH)</b>	5	Combine 1 to 1½ cups (250 - 375 mL) water with the juice and peel of one lemon in a small microwave-safe bowl. After heating, wipe interior of oven with a cloth.

## Food Characteristics

### Bone and Fat

Both bone and fat affect cooking. Bones may cause irregular cooking. Meat next to the tips of bones may overcook while meat positioned under a large bone, such as a ham bone, may be undercooked. Large amounts of fat absorb microwave energy and the meat next to these areas may overcook.

### Density

Porous, airy foods such as breads, cakes or rolls take less time to cook than heavy, dense foods such as potatoes and roasts. When reheating donuts or other foods with different centers be very careful. Certain foods have centers made with sugar, water, or fat and these centers attract microwaves (For ex., jelly donuts). When a jelly donut is heated, the jelly can become extremely hot while the exterior remains warm to the touch. This could result in a burn if the food is not allowed to cool properly in the center.

### Quantity

Two potatoes take longer to cook than one potato. As the quantity of the food increases so does the cooking time. When cooking small amounts of food such as one or two potatoes, do not leave oven unattended. The moisture content in the food may decrease and a fire could result.

### Shape

Uniform sizes heat more evenly. The thin end of a drumstick will cook more quickly than the meaty end. To compensate for irregular shapes, place thin parts toward the center of the dish and thick pieces toward the edge.

### Size

Thin pieces cook more quickly than thick pieces.

### Starting Temperature

Foods that are room temperature take less time to cook than if they are chilled, refrigerated, or frozen.

## Cooking Techniques

### Piercing

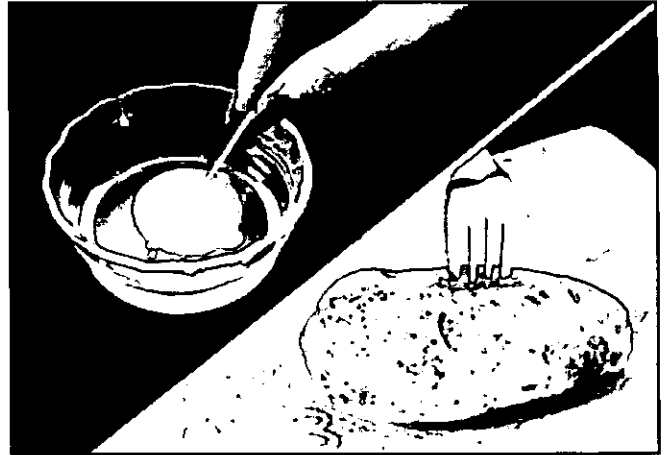

Foods with skins or membranes must be pierced, scored or have a strip of skin peeled before cooking to allow steam to escape. Pierce whole egg yolks and whites, clams, oysters, chicken livers, whole potatoes and whole vegetables. Whole apples or new potatoes should have a 1-inch strip of skin peeled before cooking. Score sausages and frankfurters.



### Browning

Foods will not have the same brown appearance as conventionally cooked foods or those foods which are cooked utilizing a browning feature. Meats and poultry may be coated with browning sauce, Worcestershire sauce, barbecue sauce or shake-on browning sauce. To use, combine browning sauce with melted butter or margarine; brush on before cooking. For quick breads or muffins, brown sugar can be used in the recipe in place of granulated sugar, or the surface can be sprinkled with dark spices before baking.

# Cooking Techniques

## Spacing

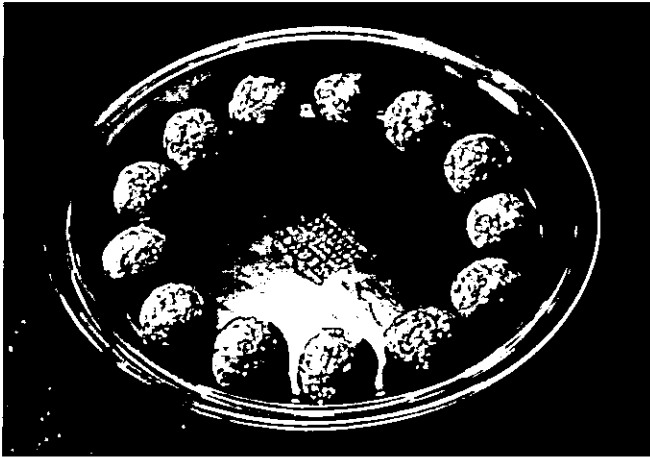

Individual foods, such as baked potatoes, cupcakes and appetizers, will cook more evenly if placed in the oven equal distances apart. When possible, arrange foods in a circular pattern.

## Covering



As with conventional cooking, moisture evaporates during microwave cooking. Casserole lids or plastic wrap are used for a tighter seal. When using plastic wrap, vent the plastic wrap by folding back part of the plastic wrap from the edge of the dish to allow steam to escape. Loosen or remove plastic wrap as recipe directs for stand time. When removing plastic wrap covers, as well as any glass lids, be careful to remove them away from you to avoid steam burns. Various degrees of moisture retention are also obtained by using wax paper or paper towels. However, unless specified, a recipe is cooked covered.

## Shielding

Thin areas of meat and poultry cook more quickly than meaty portions. To prevent overcooking, these thin areas can be shielded with strips of aluminum foil. Wooden toothpicks may be used to hold the foil in place.

## Timing

A range in cooking time is given in each recipe. The time range compensates for the uncontrollable differences in food shapes, starting temperature, and regional preferences. Always cook food for the minimum cooking time given in a recipe and check for doneness. If the food is undercooked, continue cooking. It is easier to add time to an undercooked product. Once the food is overcooked, nothing can be done.

## Stirring

Stirring is usually necessary during microwave cooking. We have noted when stirring is helpful, using the words once, twice, frequently, or occasionally to describe the amount of stirring necessary. Always bring the cooked outside edges toward the center and the less cooked center portions toward the outside of the dish.

## Rearranging

Rearrange small items such as chicken pieces, shrimp, hamburger patties, or pork chops. Rearrange pieces from the edge to the center and pieces from the center to the edge of the dish.

## Turning

It is not possible to stir some foods to redistribute the heat. At times, microwave energy will concentrate in one area of a food. To help ensure even cooking, these foods need to be turned. Turn over large foods, such as roasts or turkeys, halfway through cooking.

## Stand Time

Most foods will continue to cook by conduction after the microwave oven is turned off. In meat cookery, the internal temperature will rise 5°F to 15°F (3°C to 8°C), if allowed to stand, tented with foil, for 10 to 15 minutes. Casseroles and vegetables need a shorter amount of standing time, but this standing time is necessary to allow foods to complete cooking to the center without overcooking on the edges.

## Testing for Doneness

The same tests for doneness used in conventional cooking may be used for microwave cooking. Meat is done when fork-tender or splits at fibers. Chicken is done when juices are clear yellow and drumstick moves freely. Fish is done when it flakes and is opaque. Cake is done when a toothpick or cake tester is inserted and comes out clean. Candy is done when it reaches the proper temperature for each stage of crystallization.

# CARE OF YOUR MICROWAVE OVEN

## BEFORE CLEANING:

Unplug at socket of the oven. If impossible, leave oven door open to prevent oven from accidentally turning on.

## AFTER CLEANING:

Be sure to replace the Roller Ring and Glass Tray in the proper position and press **Stop/Reset** Pad to clear the **Display Window**.

### Inside of the oven:

Wipe with a damp cloth. Mild detergent may be used if the oven gets very dirty. The use of harsh detergents or abrasives is not recommended.

### Glass Tray:

Remove and wash in warm, soapy water or in a dishwasher.

### Outside oven surfaces.

Clean with a soft damp cloth. Do not use harsh detergents or abrasives to avoid scratches. To prevent damage to the operating parts inside the oven, water should not be allowed to seep into ventilation openings.

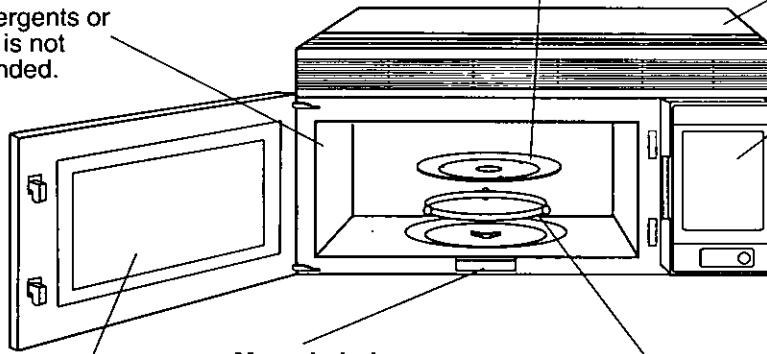

### Control Panel:

- \* Covered with a removable protective film to prevent scratches during shipping. Small bubbles may appear under this film. (Hint - To remove film, apply masking or clear tape to an exposed corner and pull gently.)
- \* If the Control Panel becomes wet, clean it with a soft, dry cloth. Do not use harsh detergents or abrasives on the Control Panel.

### Menu Label:

Do not remove. Wipe with a damp cloth.

### Oven Door:

- \* Wipe with a soft cloth when steam accumulates inside or around the outside of the oven door. During cooking, especially under high humidity conditions, steam is given off from the food. (Some steam will condense on cooler surfaces, such as the oven door. This is normal.)
- \* Inside surface is covered with a heat and vapor barrier film. Do not remove.

### Roller Ring and oven cavity floor:

Wipe the bottom surface of the oven with mild detergent, water or window cleaner and dry. Roller Ring may be washed in mild soapy water or in a dishwasher. These areas should be kept clean to avoid excessive noise.



### Shelf (NN-S262 only)

Clean with a soft damp cloth to avoid scratches.

## ORDER FORM

### DESCRIPTION

Instruction / Operating Manual (this book)

Glass Tray

Shelf (Metal Rack: NN-S262 only)

Roller Ring Assembly

Oven Light, Cooktop Light

### PART NUMBER

F00035H00AP

F06015H00AP

F06025H00AP

J290D-4N30BP

F60305H00AP

For pricing quotes, call or write the Parts & Literature Department at the phone or address listed below. Please have your credit card information readily available.

*Shipping & handling are not included. Price & availability subject to change. Sorry, no COD's.*

PANASONIC SERVICES COMPANY  
20421 84th Avenue South  
Kent, WA 98032

(800) 833-9626 - Phone  
(800) 237-9080 - FAX

You can purchase parts, accessories or locate your nearest servicenter by visiting our Web Site:  
Web Site: <http://www.Panasonic.com>

# CARE OF YOUR MICROWAVE OVEN

## Cleaning Vent Grille (Oven Air Vent)

Vent Grille can be removed and cleaned.

1. Open the oven door.
2. ① Pull the bottom of Vent Grille and ② raise the Vent Grille, ③ then pull out.

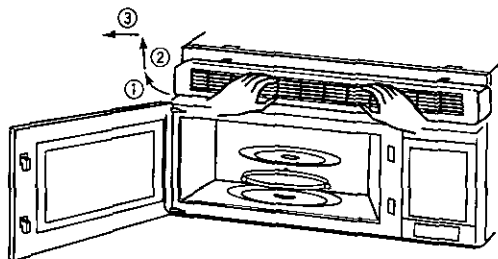

3. Soak Vent Grille in hot water with mild detergent. Wipe with a soft cloth after rinsing well. Do not use ammonia or a dishwasher.

## Installing Vent Grille

1. Open the door.
2. Insert two tabs ③ of Vent Grille into slots ① at the top of the oven.

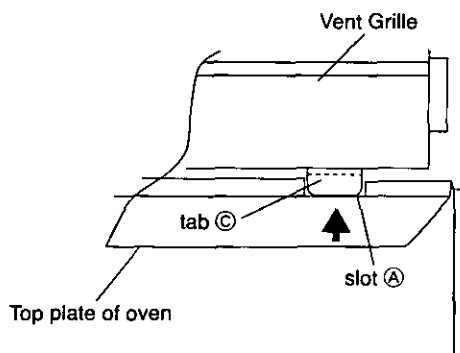
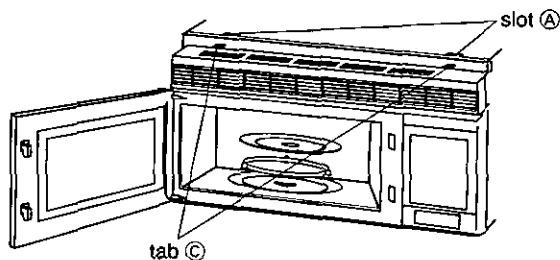

3. Push Vent Grille down to attach the metal to magnet, then push forward to insert hook ① into the slit of hook ②.

**Be sure that tabs ③ at the top and hooks ② at the bottom of Vent Grille are positioned correctly to prevent Vent Grille from falling off.**

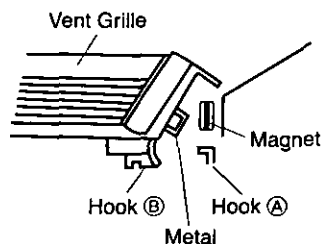

## Charcoal Filter Attachment/Replacement (Optional)

If your oven is vented inside the kitchen, the optional charcoal filter should be attached and replaced every 6 to 12 months, or more often if necessary. **The charcoal filter cannot be cleaned. To order a charcoal filter, contact your local Panasonic dealer.**

1. Remove the Vent Grille. (See "Cleaning Vent Grille".)
2. Install Charcoal Filter and adjust two holes. Secure with 2 screws provided.

Charcoal Filter (NN-CF208P)



3. Reinstall the Vent Grille. (See "Installing Vent Grille".)

## Cleaning Grease Filters

The Grease Filters should be removed and cleaned often, at least once a month.

1. Grasp the "metal ring" on the Grease Filter. Slide the Grease Filter to the rear of oven.

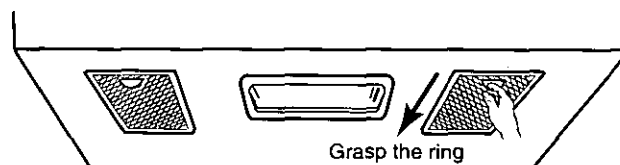

2. Pull the Grease Filter out.
3. Use care when cleaning the Grease Filters. Corrosive cleaning agents, such as lye-based oven cleaners, may damage the Grease Filters. Clean the Grease Filters with a warm detergent solution. Do not use ammonia or other alkali because it will darken metal. Light brushing can be used to remove embedded dirt. Shake and remove moisture before replacing.

## Installing Grease Filters

1. Slide in the edge of the Grease Filters along the opening's guide edges.

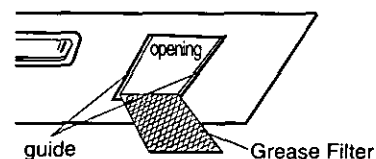

2. Push up front edge and pull forward until it fits. **Caution:** After removing the Grease Filter, be careful with the sharp edges at the openings.

Never operate the Vent Fan without the Grease Filters in place.

# CARE OF YOUR MICROWAVE OVEN

## Cooktop/Night Light Replacement

Be careful as the Cooktop Light Cover and the bulb may be hot.

1. Unplug microwave oven or disconnect power.
2. Loosen the screw to open the Cooktop Light Cover.  
(Be careful not to lose the screw.)
3. Replace the old bulb with a new one.

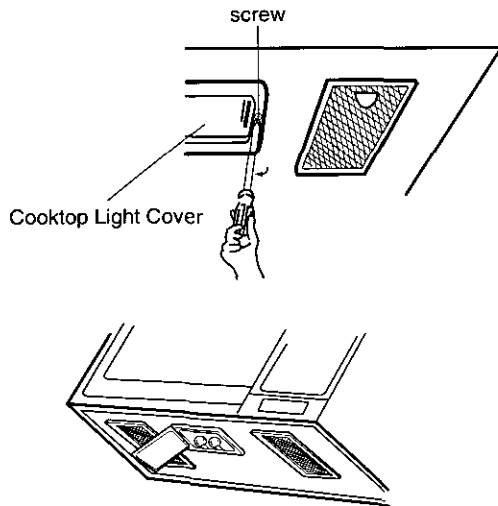

(use 115-125 V, 30 W bulb)

If this bulb is not available locally, contact your local Panasonic dealer. Part number is F60305H00AP.

4. Reinstall the Cooktop Light Cover.

## Oven Light Replacement

Be careful as the Oven Light Cover and the bulb may be hot.

1. Unplug microwave oven or disconnect power.
2. Remove the Vent Grille (and Charcoal Filter).  
(see "Cleaning Vent Grille/Charcoal Filter attachment/replacement on page 28).
3. Lift the tab of Oven Light Cover, and push back. Lift up and remove the cover.
4. Replace the old bulb with a new one.  
(use 115-125 V, 30 W bulb)  
If this bulb is not available locally, contact your local Panasonic dealer. Part number is F60305H00AP.
5. Reinstall the Oven Light cover securely aligning the hole in cover, onto the detent.

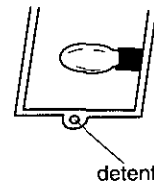
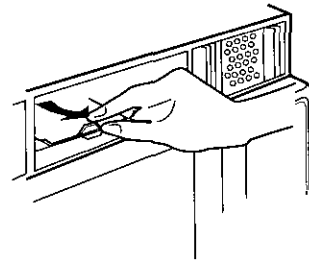

When cleaning the Oven Light Cover or the area adjacent, clean with a soft damp cloth.

Do not use harsh detergents or abrasives to avoid scratches.

# BEFORE REQUESTING SERVICE

## All these things are normal:

The oven causes interference with my TV.

Some radio and TV interference might occur when you cook with the microwave oven. This interference is similar to the interference caused by small appliances such as mixers, vacuums, blow dryers, etc.. It does not indicate a problem with your oven.

Steam accumulates on the oven door and warm air comes from the oven vents.

During cooking, steam and warm air are given off from the food. Most of the steam and warm air are removed from the oven by the air which circulates in the oven cavity. However, some steam will condense on cooler surfaces such as the oven door. This is normal.

I accidentally ran my microwave oven without any food in it.

Running the oven empty for a short time will not damage the oven. However, we do not recommend operating the microwave oven without any food in it.

### PROBLEM

### POSSIBLE CAUSE

### ACTION

Oven will not turn on.	→	The oven is not plugged in securely.	Remove plug from outlet, wait 10 seconds and reinsert.
		Circuit breaker or fuse is tripped or blown.	Reset circuit breaker or replace fuse.
		There is a problem with the outlet.	Plug another appliance into the outlet to check if it is working.
Oven will not start cooking.	→	The door is not closed completely.	Close the oven door securely.
		<b>Start</b> Pad was not pressed after programming.	Press <b>Start</b> Pad.
		Another program is already entered into the oven.	Press <b>Stop/Reset</b> Pad to cancel the previous program and enter new program.
		The program is not correct.	Program again according to the Operating Instructions.
		<b>Stop/Reset</b> Pad has been pressed accidentally.	Program oven again.
The Glass Tray wobbles.	→	The Glass Tray is not positioned properly on the Roller Ring or there is food under the Roller Ring.	Take out Glass Tray and Roller Ring. Wipe with a damp cloth and reset Roller Ring and Glass Tray properly.
When the oven is operating, there is noise coming from the Glass Tray.	→	The Roller Ring and oven bottom are dirty.	Clean according to <b>Care of Your Microwave Oven</b> .
The word "Child" appears on the <b>Display Window</b> .	→	The CHILD LOCK was activated by pressing <b>Function</b> pad and selecting "CHILD LOCK ON".	Deactivate LOCK by pressing <b>Function</b> pad, touching number 5 and selecting "CHILD LOCK OFF". (see page 12)
The word "DEMO MODE" appears on the <b>Display Window</b> .	→	Function Pad was pressed and selected "DEMO MODE ON".	Deactivate mode by pressing function pad, touching number and selecting "DEMO OFF". (see page 12)



# Limited Warranty & Customer Services Directory

PANASONIC CONSUMER ELECTRONICS COMPANY,  
DIVISION OF MATSUSHITA ELECTRIC  
CORPORATION OF AMERICA  
One Panasonic Way  
Secaucus, New Jersey 07094

PANASONIC SALES COMPANY,  
DIVISION OF MATSUSHITA  
ELECTRIC OF PUERTO RICO, INC.,  
Ave. 65 de Infanteria, Km. 9.5  
San Gabriel Industrial Park  
Carolina, Puerto Rico 00985

## Panasonic Over-The-Range Microwave Oven Limited Warranty

### Limited Warranty Coverage

If your product does not work properly because of a defect in materials or workmanship, Panasonic Consumer Electronics Company or Panasonic Sales Company (collectively referred to as "the warrantor") will, for the length of the period indicated on the chart below, which starts with the date of original purchase ("warranty period"), at its option either (a) repair your product with new or refurbished parts, or (b) replace it with a new or a refurbished product. The decision to repair or replace will be made by the warrantor.

ALL PARTS(EXCEPT MAGNETRON TUBE) MAGNETRON TUBE	PARTS 1 (ONE) YEAR 5 (FIVE) YEAR	LABOR 1 (ONE) YEAR, In-Home 1 (ONE) YEAR, In-Home
--	--	---

During the "Labor" warranty period there will be no charge for labor. During the "Parts" warranty period, there will be no charge for parts. In-Home service in the USA can be obtained during the warranty period by contacting the telephone number described below. This warranty only applies to products purchased and serviced in the United States or Puerto Rico. This warranty is extended only to the original purchaser of a new product which was not sold "as is". A purchase receipt or other proof of the original purchase date is required for warranty service.

### In-Home or Carry-In Service

For In-Home or Carry-In Service in the United States call 1-800-211-PANA(7262) or visit Panasonic Web Site: <http://www.panasonic.com> For assistance in Puerto Rico call Panasonic Sales Company (787)-750-4300 or fax (787)-768-2910.

In-Home service requires clear, complete and easy access to the product by the authorized servicer and does not include removal or re-installation of an installed product. It is possible that certain in-home repairs will not be completed in-home, but will require that the product, or parts of the product, be removed for shop diagnosis and/or repair and then returned.

### Limited Warranty Limits And Exclusions

This warranty ONLY COVERS failures due to defects in materials or workmanship, and DOES NOT COVER glass, plastic parts, temperature probes(if included) and normal wear and tear or cosmetic damage. The warranty ALSO DOES NOT COVER damages which occurred in shipment, or failures which are caused by products not supplied by the warrantor, or failures which result from accidents, misuse, abuse, neglect, mishandling, misapplication, alteration, faulty installation, set-up adjustments, misadjustment of consumer controls, improper maintenance, power line surge, lightning damage, modification, or commercial use (such as in a hotel, office, restaurant, or other business), rental use of the product, service by anyone other than a Factory Servicer or other Authorized Servicer, or damage that is attributable to acts of God.

**THERE ARE NO EXPRESS WARRANTIES EXCEPT AS LISTED UNDER "LIMITED WARRANTY COVERAGE". THE WARRANTOR IS NOT LIABLE FOR INCIDENTAL OR CONSEQUENTIAL DAMAGES RESULTING FROM THE USE OF THIS PRODUCT, OR ARISING OUT OF ANY BREACH OF THIS WARRANTY.** (As examples, this excludes damages for lost time, cost of having someone remove or re-install an installed unit if applicable, or travel to and from the servicer. The items listed are not exclusive, but are for illustration only.) **ALL EXPRESS AND IMPLIED WARRANTIES, INCLUDING THE WARRANTY OF MERCHANTABILITY, ARE LIMITED TO THE PERIOD OF THE LIMITED WARRANTY.**

Some states do not allow the exclusion or limitation of incidental or consequential damages, or limitations on how long an implied warranty lasts, so the exclusions may not apply to you.

This warranty gives you specific legal rights and you may also have others rights which vary from state to state. If a problem with this product develops during or after the warranty period, you may contact your dealer or Servicer. If the problem is not handled to your satisfaction, then write to the warrantor's Consumer Affairs Department at the addresses listed for the warrantor.

**PARTS AND SERVICE WHICH ARE NOT COVERED BY THIS LIMITED WARRANTY ARE YOUR RESPONSIBILITY.**

## Customer Services Directory

**For Product Information, Operating Assistance, Literature Request, Dealer Locations, and all Customer Service inquiries please contact:**

**1-800-211-PANA (7262), Monday-Friday 9 am-9 pm; Saturday-Sunday 9 am-7 pm, EST.**

**Web Site: <http://www.panasonic.com>  
you can purchase parts, accessories or locate  
your nearest servicer by visiting our Web Site.**

### Accessory Purchases:

1-800-332-5368 (Customer Orders Only)  
Panasonic Services Company 20421 84th Avenue South, Kent, WA 98032  
(6 am to 5 pm Monday-Friday; 6 am to 10:30 am Saturday; PST)  
(Visa, MasterCard, Discover Card, American Express, Check)

**Service in Puerto Rico**  
**Matsushita Electric of Puerto Rico, Inc. Panasonic Sales Company/Factory Servicer:**  
**Ave. 65 de Infanteria, Km. 9.5, San Gabriel Industrial Park, Carolina, Puerto Rico 00985**  
**Phone (787) 750-4300 Fax (787) 768-2910**