

This Owner's Manual is provided and hosted by [Appliance Factory Parts](http://www.appliancefactoryparts.com).

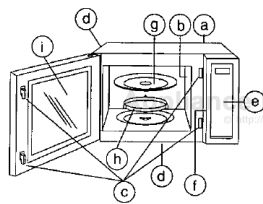

# PANASONIC NN-530WFV Owner's Manual

[Shop genuine replacement parts for PANASONIC  
NN-530WFV](#)



- Ⓐ External Air Vents
- Ⓑ Internal Air Vents
- Ⓒ Door Safety Lock System
- Ⓓ Exhaust Air Vents
- Ⓔ Control Panel
- Ⓛ Identification Plate
- Ⓜ Glass Tray
- Ⓨ Roller Ring
- Ⓩ Heat / Vapour Barrier Film (do not remove)

[Find Your PANASONIC Microwave Parts - Select From 742 Models](#)

----- Manual continues below -----

# Panasonic®

## Operating Instructions

Microwave Oven

Models NN-S530BFV  
NN-S530WFV



The serial number of this product may be found on the right side of the oven door opening. You should note the model number and the serial number of this oven in the space provided and retain this book as a permanent record of your purchase for future reference.

Model No. \_\_\_\_\_

Serial No. \_\_\_\_\_

Date of Purchase \_\_\_\_\_

Before operating this oven, please read these instructions completely.

## PRECAUTIONS TO AVOID POSSIBLE EXPOSURE TO EXCESSIVE MICROWAVE ENERGY

- (a) Do not attempt to operate this oven with the door open since open-door operation can result in harmful exposure to microwave energy. It is important not to defeat, or tamper with, the safety interlocks. Under normal conditions, the oven will not operate with the door open.
- (b) Do not place any object between the oven front face and the door, or allow soil or cleaner residue to accumulate on sealing surfaces.
- (c) Do not operate the oven if it is damaged. It is particularly important that the oven door closes properly and that there is no damage to the following:
  - (1) door (bent)
  - (2) hinges and latches (broken or loosened)
  - (3) door seals and sealing surfaces.
- (d) The oven should not be adjusted, or repaired, by anyone except properly qualified service personnel.

## TABLE OF CONTENTS

### Operating Instructions

Technical Specifications .....	below
Important Safety Instructions .....	1
Installation and Grounding Instructions .....	2
Safety Precautions .....	3
Care of Your Microwave Oven .....	4-5
Features .....	6
Control Panel .....	6
Controls and Operating Procedures .....	7-10
Quick Guide to Operation .....	15

### Cooking Guide

Cooking with Microwave Energy .....	11
Cookware and Utensil Guide .....	12
Microwave Shortcuts .....	13

### Main tenance

Before Requesting Service .....	14
---------------------------------	----

## Technical Specifications

	<b>NN-S530</b>
Electricity:	120 V, 60 Hz
Power consumption:	12 A, 1300 W
Output:*	1000 W*
Outside Dimensions (H x W x D):	301 mm x 518 mm x 407 mm
Oven Cavity Dimensions (H x W x D):	225 mm x 375 mm x 386 mm
Operating Frequency:	2,450 MHz
Uncrated Weight:	10.5 kg (23 lb)

\*IEC 705-88 Test Procedure used

Specifications subject to change without notice.

# IMPORTANT SAFETY INSTRUCTIONS

Your microwave oven is a cooking device and you should use as much care as you use with a stove or any other cooking device. When using this electric appliance, basic safety precautions should be followed, including the following:

**WARNING**—To reduce the risk of burns, electric shock, fire, injury to persons, or exposure to excessive microwave energy:

1. Read all instructions before using the appliance.
2. Read and follow the specific **“PRECAUTIONS TO AVOID POSSIBLE EXPOSURE TO EXCESSIVE MICROWAVE ENERGY,”** found inside of the front cover.
3. This appliance must be grounded. Connect only to properly grounded outlet. See **“GROUNDING INSTRUCTIONS”** found on page 3.
4. Install or locate this appliance only in accordance with the installation instructions found on page 3.
5. Do not cover or block any openings on this appliance.
6. Do not store or use this appliance outdoors. Do not use this product near water—for example, near a kitchen sink, in a wet basement, or near a swimming pool, and the like.
7. Use this appliance only for its intended use as described in this manual. Do not use corrosive chemicals, vapors, or non-food products in this appliance. This type of oven is specifically designed to heat, cook or dry food. It is not designed for industrial or laboratory use. The use of corrosive chemicals in heating or cleaning will damage the appliance and may result in radiation leaks.
8. When cleaning surfaces of door and oven that come together on closing the door, use only mild, non-abrasive soaps or detergents applied with a sponge or soft cloth.
9. Do not allow children to use this appliance, unless closely supervised by an adult.
10. Do not operate this appliance if it has a damaged cord or plug, if it is not working properly, or if it has been damaged or dropped.
11. Do not immerse cord or plug in water.
12. Keep cord away from heated surfaces.
13. Do not let cord hang over edge of table or counter.
14. This appliance should be serviced only by qualified service personnel. Contact the nearest authorized service facility for examination, repair or adjustment.
15. Some products such as whole eggs, narrow neck bottles and sealed containers—for example, closed glass jars—may explode and should not be heated in this oven.

16. To reduce the risk of fire in the oven cavity:
  - (a) Do not overcook food. Carefully attend appliance if paper, plastic, or other combustible materials are placed inside the oven to facilitate cooking.
  - (b) Remove wire twist-ties from paper or plastic bags before placing bag in oven.
  - (c) **If materials inside the oven should ignite, keep oven door closed, turn oven off, and disconnect the power cord, or shut off power at the fuse or circuit breaker panel.**
  - (d) Do not use the cavity for storage purposes. Do not leave paper products, cooking utensils, or food in the cavity when not in use.

## General Use

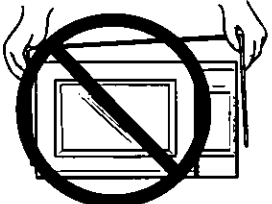
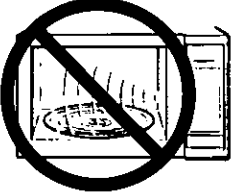
1. **DO NOT** tamper with or make any adjustments or repairs to door, control panel housing, safety interlock switches or any other part of the oven. **DO NOT** remove outer panel from oven. Repairs should only be done by a qualified service person. 
2. **DO NOT** operate the oven empty. The microwave energy will reflect continuously throughout the oven if food or water is not present to absorb energy. This could damage the oven and result in the risk of a fire. 
3. **DO NOT** dry clothes, newspapers or other materials in oven, or use newspapers or paper bags for cooking. Fire could result.
4. **DO NOT** use recycled paper products unless the paper product is labeled as safe for microwave oven use. Recycled paper products may contain impurities which may cause sparks, and result in fires when used.
5. **DO NOT** hit or strike control panel. Damage to controls may occur. Fire could result.
6. **POT HOLDERS** should always be used when removing items from the oven. Heat is transferred from the **HOT** food to the cooking container and from the cooking container to the Glass Tray. The Glass Tray can be very **HOT** after removing cooking container from oven.
7. **DO NOT** store flammable materials next to, on top of, or in the oven. These could be fire hazards.

# SAVE THESE INSTRUCTIONS

For proper use of your oven read remaining safety cautions and operating instructions.

# INSTALLATION AND GROUNDING INSTRUCTIONS

## Examine Your Oven

Unpack oven, remove all packing material, and examine the oven for any damage such as dents, broken door latches or cracks in the door. Notify dealer immediately if oven is damaged. **DO NOT** install if oven is damaged.

## Installation of Your Oven

1. This oven is designed for installation into a wall cabinet.
2. This oven must be installed so that no part is located less than 5 feet (1.52 m) above floor level.
3. **DO NOT** block air vents, if they are blocked during operation, the oven may overheat. If the oven overheats, a thermal safety device will turn the oven off. The oven will remain inoperable until it has cooled.
4. This oven was manufactured for household use only.

## Grounding Instructions

**This appliance must be grounded.** In the event of an electrical short circuit, grounding reduces the risk of electric shock by providing an escape wire for the electric current. This appliance is equipped with a cord having a grounding wire with a grounding plug. The plug must be plugged into an outlet that is properly installed and grounded.

**WARNING—Improper use of the grounding plug can result in a risk of electric shock.**

Consult a qualified electrician or service person if the grounding instructions are not completely understood, or if doubt exists as to whether the appliance is properly grounded. If it is necessary to use an extension cord, use only a three wire extension cord that has a three blade grounding plug, and a three slot receptacle that will accept the plug on the appliance. The marked rating of the extension cord should be equal to or greater than the electrical rating of the appliance.

## Wiring Requirements

1. The oven must be on a **SEPARATE CIRCUIT**. No other appliance should share the circuit with the microwave oven. If it does, the branch circuit fuse may blow, the circuit breaker may trip, or the food may cook slower than the times recommended in this manual.
2. The **VOLTAGE** used must be the same as specified on this microwave oven (120 V, 60 Hz). Using a higher voltage is dangerous and may result in a fire or other accident causing oven damage. Using a lower voltage will cause slow cooking. Panasonic is **NOT** responsible for damage resulting from the use of the oven with other than specified voltage.
3. The oven must be plugged into at least a **20 AMP, 120 VOLT, 60 Hz GROUNDED OUTLET**. Where a standard two-prong outlet is encountered, it is the personal responsibility and obligation of the consumer to have it replaced with a properly grounded three-prong outlet.

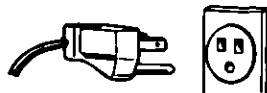

## TV/Radio Interference

1. Operation of the microwave oven may cause interference to your radio, TV or similar equipment.
2. When there is interference, it may be reduced or eliminated by taking the following measures:
  - a. Clean door and sealing surfaces of the oven. (See Care of Your Microwave Oven)
  - b. Place the radio, TV, etc. away from the microwave oven as far as possible.
  - c. Use a properly installed antenna to obtain stronger signal reception.

## Glass Tray

1. **DO NOT** operate the oven without the Roller Ring and the Glass Tray in place.
2. **DO NOT** operate the oven without the Glass Tray fully engaged on the drive hub. Improper cooking or damage to the oven could result. Verify that the Glass Tray is properly engaged and rotating by observing its rotation when you press **Start**.
3. Only use the Glass Tray specifically designed for this oven. Do not substitute any other glass tray.
4. If the Glass Tray is hot, allow to cool before cleaning or placing in water.
5. **DO NOT** cook directly on the Glass Tray. Always place food in a microwave-safe dish, or on a rack set in a microwave-safe dish.
6. If the food or utensil on the Glass Tray touches oven walls, causing the tray to stop moving, the tray will automatically rotate in the opposite direction. This is normal.
7. The Glass Tray can turn in either direction.

## Roller Ring

1. The Roller Ring and oven floor should be cleaned frequently to prevent excessive noise.
2. The Roller Ring must always be used for cooking along with the Glass Tray.
3. Always replace the Roller Ring and the Glass Tray in their proper positions.

# Safety Precautions

## Follow These Safety Precautions When Cooking in Your Oven

### IMPORTANT

Proper cooking depends upon the power, the time set and quantity of food. If you use a smaller portion than recommended and cook at the time for the recommended portion, fire can result.

#### 1) HOME CANNING / DRYING FOODS / SMALL QUANTITIES OF FOODS

- **Do not** use your oven for home canning, your oven cannot maintain the food at the proper canning temperature. Improperly canned food may spoil and be dangerous to consume.
- **Do not** dry meats, herbs, fruits or vegetables in your oven. Small quantities of food or foods with low moisture content can dry out, scorch or catch on fire if overheated.

#### 2) POPCORN

Popcorn may be popped in a microwave oven corn popper. Microwave popcorn which pops in its own package is also available. Follow popcorn manufacturers' directions and use a brand suitable for the wattage of your microwave oven.

**CAUTION: When using pre-packaged microwave popcorn, follow recommended package instructions. Check package weight before using the Popcorn pad (see Popcorn Pad section). Set the oven for the weight of the popcorn package. If these instructions are not followed, the popcorn may not pop adequately or may ignite and cause a fire. Never leave oven unattended when popping popcorn. Allow the popcorn bag to cool before opening, always open the bag away from your face and body.**

#### 3) DEEP FAT FRYING

- **Do not** attempt to deep fat fry in your microwave oven. Cooking oils may burst into flames and may cause damage to the oven and perhaps result in burns. Microwave utensils may not be able to withstand the temperature of the hot oil, and could shatter or melt.

#### 4) FOODS WITH NONPOROUS SKINS

- **Potatoes, apples, egg yolks, whole eggs, whole squash and sausages are examples of foods with nonporous skins.** These types of foods must be pierced before microwave cooking to prevent their bursting.
- Use fresh potatoes for baking and cook until just done. Use recommended weights for programmed cooking. Overcooking causes dehydration and may result in a fire.

#### 5) LIQUIDS

- Heated liquids can erupt if not mixed with air. **DO NOT** heat liquids in your microwave oven without first stirring.

#### 6) GLASS TRAY / COOKING UTENSILS / FOIL

- Cooking utensils get hot during microwaving. Heat is transferred from the HOT food to the container and the Glass Tray. Use potholders when removing utensils from the oven or when removing lids or plastic wrap covers from cooking utensils to avoid burns.
- The glass tray will get hot during cooking. It should be allowed to cool before handling or before paper products, such as paper plates or microwave popcorn bags, are placed in the oven for microwave cooking.
- When using foil, skewers, warming rack or utensils made of metal in the oven, allow at least 1-inch (2.5 cm) of space between metal material and interior oven walls. If arcing occurs (sparking), remove metal material (skewers etc.) and/or transfer to a non-metallic container.
- Dishes with metallic trim should not be used, as arcing may occur.
- If an entree is heated in a foil tray, maintain at least 1-inch (2.5 cm) spacing from the oven walls.

#### 7) PAPER TOWELS / CLOTHS

- **DO NOT** use paper towels or cloths which contain a synthetic fiber woven into them. The synthetic fiber may cause the towel to ignite. Use paper toweling under supervision.

#### 8) BROWNING DISHES / OVEN COOKING BAGS

- Browning dishes or grills are designed for microwave cooking only. Always follow instructions provided by the manufacturer. **DO NOT** preheat browning dish more than 6 minutes.
- If an oven cooking bag is used for microwave cooking, prepare according to package directions. **DO NOT** use a wire twist-tie to close bag, instead use plastic ties, cotton string or a strip cut from the open end of the bag.

#### 9) THERMOMETERS

- **DO NOT** use a conventional meat thermometer in your oven. Arcing may occur. Microwave-safe thermometers are available for both meat and candy.

#### 10) BABY FORMULA / FOOD

- **DO NOT** heat baby formula or food in the microwave oven. The glass jar or surface of the food may appear warm while the interior can be so hot as to burn the infant's mouth and esophagus.

#### 11) REHEATING PASTRY PRODUCTS

- When reheating pastry products, check temperatures of any fillings before eating. Some foods have fillings which heat faster and can be extremely hot, while the surface remains warm to the touch (ex. Jelly Donuts).

#### 12) GENERAL OVEN USAGE GUIDELINES

- **DO NOT** use the oven for any reason other than the preparation of food.
- **DO NOT** leave oven unattended while in use.

# Care of your Microwave Oven

## Utensils

1. MICROWAVE BROWNING DISHES or GRILLS are designed for microwave cooking only. Preheating times vary depending on the size of the browning dish and food being cooked. Always follow instructions provided by the browning dish or grill manufacturer.  
DO NOT PREHEAT BROWNING DISH MORE THAN 6 MINUTES in microwave.
2. METAL CONTAINERS or dishes with metallic trim should not be used. Arcing ( sparking ) may occur.
3. METAL TWIST-TIES should not be used in the microwave oven, arcing will occur.
4. DO NOT use SEALED JARS or NARROW NECK bottles for cooking or reheating. They may shatter.
5. DO NOT use CONVENTIONAL THERMOMETERS in the microwave oven. They may cause arcing.
6. Remove PLASTIC STORE WRAPS, before cooking or defrosting in the oven.
7. If an oven cooking bag is used, prepare according to package directions. Do not use wire twist-tie to close bag. Instead use plastic tie, a piece of cotton string or a strip cut from the open end of the bag. Make six 1 cm ( 1/2" ) slits by closure. Place oven cooking bag in a dish slightly larger than the food being cooked.
8. When using foil, skewers, rack or utensils made of metal in the oven, allow at least 2.5 cm ( 1" ) of space between metal material and interior oven walls. If arcing occurs remove metal material (skewers, etc.) and/or transfer to a non-metallic container.
9. Do not use paper towels or cloths which contain a synthetic fiber woven into them, such as nylon. The synthetic fiber may cause the towel or cloth to ignite. Use paper toweling under supervision.

## Food

1. Do not use your oven for home canning or the heating of any closed jar. Pressure will build up and the jar may explode. In addition, the microwave oven cannot maintain the food at the proper canning temperature. Improperly canned food may spoil and be dangerous to consume.
2. Small quantities of food or foods with low moisture content can dry out, burn or catch on fire when overheated. If a fire occurs, turn oven off and leave oven door closed. Disconnect the power cord or shut off power at the fuse or circuit breaker panel.
3. Popcorn can be popped in a suitable, microwaveable corn popper using manufacturer's directions OR prepackaged bags of microwave popcorn can be used with the preset **Popcorn** Pad program. Treat bag according to package directions.
4. Do not attempt to deep fry in your microwave oven. Temperature cannot be controlled and fat will erupt. Many microwave utensils cannot withstand the temperatures of heated oil, resulting in shattering or melting.
5. Do not boil eggs in their shell. Pressure will build up and the eggs will explode.
6. Potatoes, apples, egg yolks and whites, whole squash and sausages are examples of foods with nonporous skins. This type of food must be pierced before cooking, to prevent bursting.
7. Use fresh potatoes, and cook until just done. The potatoes will still feel soft to the touch, but firm when pierced with a fork. Overcooking causes dehydration and may cause a fire.
8. Heated liquids can erupt if not mixed with air. Do not heat liquids in your microwave oven without first stirring. Overheated liquids will erupt.
9. Heat only 1 frozen dinner or entree in the oven at a time. If dinner or entree is heated in a foil tray, leave at least 2.5 cm ( 1" ) of space between foil tray and oven walls.
10. Drying meats, fruits, vegetables and herbs is not recommended .
11. Do not use the oven for any reason other than the preparation of food.
12. Do not leave oven unattended.

# Care of your Microwave Oven

## BEFORE CLEANING:

Unplug at socket of the oven. If impossible, leave oven door open to prevent oven from accidentally turning on.

## AFTER CLEANING:

Be sure to replace the Roller Ring and Glass Tray in the proper position and press Stop/Reset Pad to clear the screen.

### Inside of the oven:

Wipe with a damp cloth. Mild detergent may be used if the oven gets very dirty. The use of harsh detergent or abrasives is not recommended.

### Glass Tray:

Remove and wash in warm soapy water or in a dishwasher.

### Outside oven surfaces.

Clean with a damp cloth. To prevent damage to the operating parts inside the oven, water should not be allowed to seep into ventilation openings.

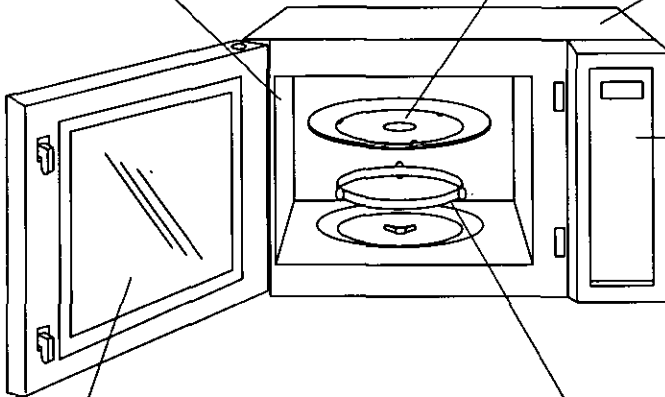

### Control Panel:

- \* Covered with a removable protective film to prevent scratches during shipping. Small bubbles may appear under this film. (Hint - To remove film, apply masking or clear tape to an exposed corner and pull gently.)
- \* If the control panel becomes wet, clean it with a soft dry cloth. Do not use harsh detergents or abrasives on the Control Panel.

### Oven Door:

Wipe with a soft cloth when steam accumulates inside or around the outside of the oven door. During cooking, especially under high humidity conditions, steam is given off from the food. (Some steam will condense on cooler surfaces, such as the oven door.) This is normal.

### Roller Ring and oven cavity floor:

Wipe the bottom surface of the oven with mild detergent water or window cleaner and dry. Roller Ring may be washed in mild soapy water or dishwasher. These areas should be kept clean to avoid excessive noise.

## ORDER FORM

For more information regarding microwave cooking, order our new **COOKING GUIDE** (68 pages of recipes & charts).

DESCRIPTION	PART NUMBER
Instruction / Operating Manual (this book)	F00034T60CP
COOKING GUIDE	B000B8250AP
Glass Tray	A06014T00AP
Roller Ring Assembly	B290D9330AP

For pricing quotes, call or write the Parts & Literature Department at the phone or address listed below. Please have your credit card information readily available.

*Shipping & handling are not included. Price & availability subject to change. Sorry, no COD's.*

PANASONIC SERVICES COMPANY  
20421 84th Avenue South  
Kent, WA 98032

(800) 833-9626 - Phone  
(800) 237-9080 - FAX

You can purchase parts, accessories or locate your nearest service center by visiting our Web Site:  
**Web Site: <http://www.Panasonic.com>**



# Feature Diagram

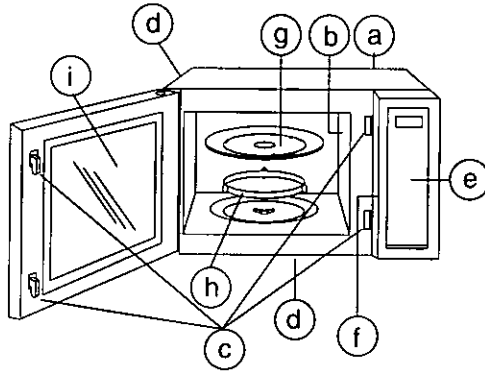

- (a) External Air Vents
- (b) Internal Air Vents
- (c) Door Safety Lock System
- (d) Exhaust Air Vents
- (e) Control Panel
- (f) Identification Plate
- (g) Glass Tray
- (h) Roller Ring
- (i) Heat / Vapour Barrier Film (do not remove)

# Control Panel

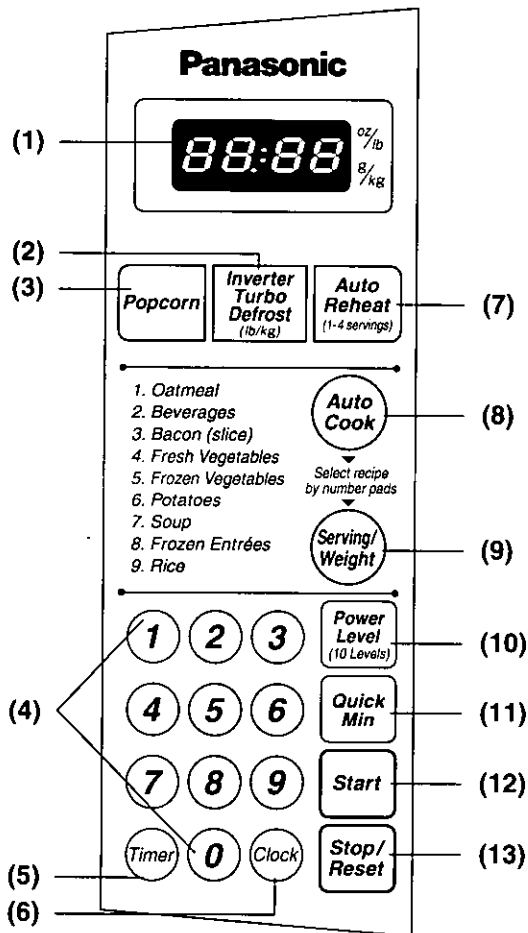

- (1) **Display Window**  
This oven displays weight in oz/lb or in g/kg. Press Start Pad immediately to select the system you desire. The indicator appears to select the system.
- (2) **Inverter Turbo Defrost Pad** (☛ page 8)
- (3) **Popcorn Pad** (☛ page 8)
- (4) **Number Pads**
- (5) **Timer Pad** (☛ page 10)
- (6) **Clock Pad** (☛ page 7)
- (7) **Auto Reheat Pad** (☛ page 9)
- (8) **Auto Cook Pad** (☛ page 9)
- (9) **Serving/Weight Pad**
- (10) **Power Level Pad** (☛ page 9)
- (11) **Quick Min Pad** (☛ page 10)
- (12) **Start Pad**  
One tap allows oven to begin functioning. If door is opened or **Stop/Reset** Pad is pressed once during oven operation, **Start** Pad must again be pressed again to restart oven.
- (13) **Stop/Reset Pad**  
**Before cooking:** One tap clears your instruction.  
**During cooking:** One tap temporarily stops the cooking process. Another tap cancels all your instructions and time of day or colon appears in the Display Window.

**Beep Sound:**  
When a pad is pressed correctly, a beep will be heard. If a pad is pressed and no beep is heard, the unit did not or cannot accept the instruction. The oven will beep twice between programmed stages. At the end of any complete program, the oven will beep 5 times.



# Operating Procedures

## Using Timed Cook Programs

These are pre-timed for an average quantity of food. Local power fluctuations and personal tastes are not taken into account. Should you prefer food cooked differently, use power and time, as directed in the cooking guide section, other recipe sources or package directions. (See "To Use Auto Cook Pads" on page 9.)

## To Use Inverter Turbo Defrost:

Use to defrost meat, poultry or seafood by using the weight on the package.



1. Press *Inverter Turbo Defrost* Pad.

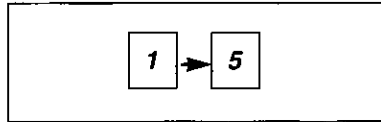

2. Enter weight using number pad.  
Ex.: 1.5 kg or 1.5 lbs



3. Press *Start* Pad.

- The recommended maximum weight of meat is 1.8 kg (4 lb); poultry, 2.7 kg (6 lb) and seafood, 1.4 kg (3 lb).
- The weight for *Inverter Turbo Defrost* can be programmed up to 3 kg (6 lb).
- Power and time may be programmed after *Inverter Turbo Defrost*.
- If you are using the Imperial system, be sure to convert oz to decimal equivalent, i.e., 8 oz = .5 lb, 4 oz = .25 lb etc.

## To Use Popcorn:



1. Press *Popcorn* Pad until the desired weight appears in the *Display Window*.

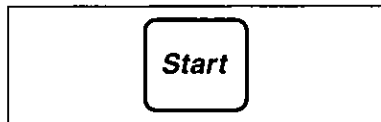

2. Press *Start* Pad.  
Cooking time appears and begins to count down.

- Use prepackaged **room temperature** microwave popcorn. Read manufacturers' instructions.
- Place bag in oven according to manufacturers' directions.
- Pop only one bag at a time.
- After popping, allow the contents of the bag to cool for a few minutes before opening. Open bag carefully away from face and body because popcorn and steam are extremely hot.
- Do not reheat unpopped kernels or reuse bag.
- **NEVER** leave oven unattended when popping popcorn.

**REMARK:** When popping multiple bags one right after the other, the cooking times may vary slightly. This does not affect the popcorn results.

**CAUTION:** If pre-packaged popcorn is a different weight than is recommended, do not use the popcorn setting, or inadequate popping or a fire may occur. Follow the manufacturers' instructions.

## To Use Child Safety Lock Control

Using this system will make the oven controls inoperable; however, the door will open. You can set the Child Lock when the display shows a colon or the time of day.



1. Press *Start* Pad three times.

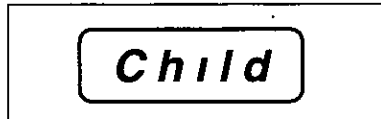

Time of day will disappear and "Child" will appear in the *Display Window*. Actual time will not be lost.



2. To cancel "Child" press *Stop/Reset* Pad three times. Colon or time of day will reappear in the *Display Window*.

# Operating Procedures

## To Use Auto Reheat:



1. Press **Auto Reheat** Pad until the desired number of servings (1-4) appears in the **Display Window**.



2. Press **Start** Pad. Cooking time appears in the **Display Window** and begins to count down.

Type of Food	Quantity
Plate of Food	Usually 3-4 servings
Meat, Poultry	1 piece 120 g (4 oz)
Casseroles	220 g (8 oz)
Soup, Gravy, Sauce	250 mL (1 cup)

## To Use AUTO COOK Pads:

This feature allows you to cook most of your favourite foods without setting power and time.



1. Press the **Auto Cook** Pad to select the desired category.



2. Press **Serving/Weight** Pad to select desired weight (see the chart below).



3. Press **Start** Pad. Time for cooking will appear in the **Display Window** and begin to count down.

Category	Serving/Weight	Instructions
1. Oatmeal	0.5, 1 cup	Place inside a microwave-safe serving bowl with no cover. Follow manufacturers' directions for preparation of quick oatmeal.
2. Beverages	1, 2 cups	Use a microwave-safe coffee cup. Heated liquids can erupt if not mixed with air. Do not heat liquids in your microwave oven without stirring first.
3. Bacon (slice)	4, 6, 10, 14 slices	Place slices of bacon on a microwave-safe dish. Cover with paper towel. Times may vary by brand (weight).
4. Fresh Vegetables	4, 8, 12, 16 oz (110, 225, 340, 450 g)	All pieces should be the same size. Add a small amount of water and cover loosely with lid or vented plastic wrap.
5. Frozen Vegetables	6, 10, 16 oz (170, 300, 450 g)	Follow manufacturers' directions. Do not salt until after cooking. Not suitable for vegetables in butter or sauce.
6. Potatoes	1, 2, 3, 4 pieces (6-8 oz each) (170-225 g each)	Pierce skin with fork 6 times on top. Place potatoes on a microwave-safe dish. Do not cover. Let stand 5 minutes to complete cooking.
7. Soup	1, 2 cups	Pour soup into a microwave-safe serving bowl. Cover loosely with lid or vented plastic wrap.
8. Frozen Entrées	8, 10, 20, 32 oz (225, 300, 600, 900 g)	Follow manufacturers' directions for covering or removing covers. For best results, do not use frozen foods packaged in foil tray.
9. Rice	0.5, 1, 1.5 cups	Place rice with hot water in a microwave-safe casserole dish. Cover loosely with lid or vented plastic wrap. Let stand 5 to 10 minutes before serving.

# Operating Procedures

## To Set Timer: (To use as a kitchen timer)

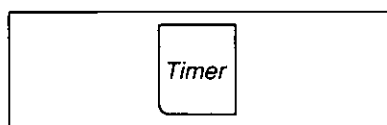

1. Press **Timer Pad**.

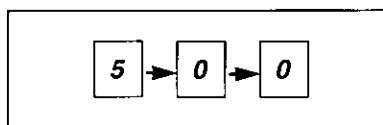

2. Enter length of time for count down.  
e.g. 5.00 minutes

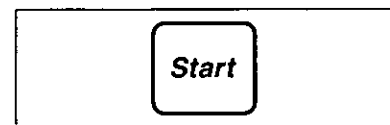

3. Press **Start Pad**.  
Time will count down without oven operating.

- To delay the start of cooking for 20 minutes:

e.g. **TIMER → 20 min.** → **P10 (HIGH) → 5 min.** → **P6 (MED) → 20 min.** → **START**  
 Delay Start                      Stage 1                      Stage 2

- For standing time of 7 minutes after a cooking program of 1-2 stages:

e.g. **P3 (MED-LOW) → 25 min.** → **TIMER → 7 min.** → **START**  
 Cook Program                      Standing Time

## To Use Quick Min Function:

This feature allows you to set and/or add cooking times easily in multiples of one minute.

### To Set Cooking Time:



1. Press to set cooking time (up to 10 minutes).



2. Press **Start pad**.  
Cooking will start on **P10 (HIGH)** power.

- To use other power levels, select the desired power level before setting the cooking time.
- If you use **Quick Min Pad** to set your cooking time, you cannot use the Number Pads to set more time or to change the cooking time.

### To Add Extra Cooking Time during cooking:



Press **Quick Min Pad** to add extra cooking time (up to 10 taps) during cooking.

- Cooking time changes to include extra time and continues to count down in the **Display Window**.
- Extra time can be added during any of the cooking stages.

# Cooking with Microwave Energy

Microwave energy is a form of high frequency electromagnetic energy much like radio waves. Electricity is converted by the magnetron into microwaves. In the oven, these waves are reflected by the metal oven walls and bounce around to assist in cooking food. Metal dishes may prevent food from cooking or cause arcing (bluish sparks), therefore, are not recommended. Arcing may damage the oven.

**Microwaves pass through** glass, paper, and plastic. These materials allow cooking from all sides.

**Food absorbs** microwave energy to a depth of 2 to 5 cm ( $\frac{3}{4}$ " -  $1\frac{1}{2}$ " )

The molecules, particularly water, fat and sugar, in food are excited, producing **heat of friction**; hence, cooking. Heat is **conducted** to the centre of food to finish cooking.

Microwave cooking utilizes the moisture in food for cooking, which keeps food from drying.

Room **temperature** foods will cook faster than refrigerated or frozen. **Dense** food, such as potatoes, will take much longer to cook than porous food, such as cake.

Cooking time will increase with the **quantity**. Two potatoes will take twice as long as one.

Choose items of the **same size and shape** to cook together or cut them in similar sizes. When items have an irregular shape, place the thick areas toward the outside of the dish.

Thin or bony areas may be **shielded** with small pieces of aluminum foil for one third the cooking time. Make sure pieces of foil are kept 3 cm (1") away from each other and the oven walls, to prevent arcing.

**Arrange** or space foods evenly and in a circular pattern. **Rearrange** uneven shapes and dense food, especially poultry, once or twice during cooking, by **turning over**.

**Stir** mixtures at least once and sauces several times, to allow even thickening. Some ingredients may heat faster, or to a higher temperature than others.

Some foods may not **brown** as in conventional cooking, due to the absence of heat and short cooking period. Foods such as meat, may be colour and flavour enhanced by Kitchen Bouquet, soya sauce or powdered colour and flavour mixes, spices such as paprika and celery salt. For baked items, substitute whole wheat flour and brown sugar.

Foods with a **skin**, such as egg yolk, egg white, liver, sausage, clams, oysters and whole vegetables should be **pierced** so they do not burst.

Foods usually benefit from **covering** to hold in the heat. Use matching lids and microwaveable plastic wrap for steaming, white paper towel and waxed paper to prevent spattering and hold in heat. When removing covers, **use care** to prevent steam burns. Some foods will not require a cover.

**Time cooking** for the least amount of time suggested. Food will continue to cook during **standing time**, which may be in or out of the oven. Extra cooking time may be added after standing time. Fat and bone can make food cook at an irregular rate.

Check poultry and meat with a meat thermometer to determine **doneness**. Poultry should reach 85°C (185°F), have clear juices when pierced and be steaming hot. Fish is cooked when opaque and flakes with a fork. Cakes are done when they pull away from the edge of the pan and a wooden pick inserted in the centre comes out clean.

## Power Levels

Press	Power Level
once	P10 (HIGH)
twice	P9
3 times	P8
4 times	P7 (MEDIUM-HIGH)
5 times	P6 (MEDIUM)
6 times	P5
7 times	P4
8 times	P3 (MEDIUM-LOW)
9 times	P2
10 times	P1 (LOW)

## Using other cookbooks

You may use other microwave cookbooks to expand your selection of recipes. Panasonic ovens may cook about 10% faster than other ovens or older ovens. There are two methods to adjust recipes:

- Select one power level lower than your recipe requires and use the recommended cooking time; OR
- Reduce the cooking time by 10%, but use the recommended power level.

Always check food before the shortest cooking time has lapsed.

# Cookware and Utensil Guide

ITEM	MICROWAVE	COMMENTS
Aluminum Foil	for shielding	Small strips of foil can be molded around thin parts of meat or poultry to prevent overcooking. Arcing can occur if foil is too close to the oven wall (rack).
Browning Dish	Yes	Check browning dish information for instructions and heating chart. Do not preheat for more than 6 minutes.
Dinnerware Oven/Microwave Safe Non-Oven Safe	Yes use dish test below*	Check manufacturers' use and care directions for suitability for microwave heating. Some dinnerware may state on the back of the dish, "Microwave Oven Proof." Do not use cracked or chipped dishes.
Frozen Dinner Tray Metal	Yes	Frozen dinners may be heated in foil tray, if tray is less than 2 cm (3/4-inch) high. Place foil tray in centre of oven. Leave at least 2.5 cm (1-inch) space between foil tray and oven walls. Heat only 1 foil tray in the oven at a time. For containers more than 2 cm (3/4-inch) deep, remove and place in a similar size microwave-safe container.
Plastic	Yes	
Glass-Ceramic	Yes	If in doubt, use container test described below.
Metal Bakeware	No	Not recommended for use with microwave.
Metal Twist Ties	No	They may cause arcing which could cause a fire in the oven.
Microwave Rack	Yes	Often made of plastic.
Oven Cooking Bags	Yes	Follow manufacturers' directions. Close bag with either the nylon tie provided, a strip cut from the end of the bag, or a piece of cotton string. Do not close with a metal twist tie. Make six 1 cm (1/2-inch) slits by closure.
Ovenable Glassware	Yes	Do not use cracked or chipped dishes.
Ovenable Paperboard	Yes	Use with supervision.
Paper bags	No	May cause a fire in the oven.
Paper Towels/Napkins/Plates	with supervision	Never use recycled paper.
Parchment Paper	Yes	Use as a cover to prevent spattering.
Plastic Cookware: Microwave-Safe Non-Microwave Safe (Melamine)	Yes No	Should be labelled, "Suitable for microwave heating." Check manufacturers' directions for recommended uses. Some microwave-safe plastic dishes are not suitable for cooking foods with high fat content.
Plastic foam cups	short term	Use to bring foods to a low serving temperature. Foam will melt if foods reach a high temperature.
Plastic Wrap	Yes	Use to cover foods during cooking to retain moisture.
Thermometers Microwave-safe, only Conventional	Yes No	Meat and candy thermometers are available.
Waxed paper	Yes	Use as a cover to prevent spattering and to retain moisture.

\* **To test a porcelain container for safe microwave oven use:** Fill a 250 mL (8 oz) glass measure with water and place it in the microwave oven along with the container to be tested; heat one minute at **P10 (HIGH)**. If the container is microwave oven-safe, it should remain comfortably cool and the water should be hot. If the container is hot, it has absorbed some microwave energy and should not be used. This test cannot be used for plastic containers. Check manufacturers' directions to determine if material is heat safe to 200°C (400° F).

# Microwave Helpful Hints

FOOD	POWER	COOKING TIME (in minutes)	DIRECTIONS
Bacon, to separate, 500 g (1 lb)	P10(HIGH)	1/2	Remove the wrapper. After heating, use a plastic spatula to separate slices.
Brown Sugar, to soften 1 square 30 g (1 oz) Chocolate, to melt,	P10(HIGH)	30 to 40 seconds	Place 250 mL (1 cup) hard brown sugar in a dish with a slice of bread or a wedge of apple. Cover with plastic wrap.
Butter, to melt, 125 g (4 oz) Butter, to soften, 125 g (4 oz)	P6(MEDIUM) P3(MEDIUM-LOW)	1 to 1 1/2 1 to 1 1/2	Remove the wrapper and place the butter in a dish.
Canned Foods, 450 mL (16 oz) Soup, 284 mL (10 oz) plus water	P10(HIGH) P10(HIGH)	3 to 4 4 to 6	Remove from the can, place in a covered dish. Stir once.
Chocolate, to melt, 1 square 30 g (1 oz) Chocolate, to melt, 125 g (1/2 cup) chips	P10(HIGH) P10(HIGH)	1/2 to 1 1 to 1 1/2	Remove wrapper and place chocolate in a dish. Stir before adding more time. Chocolate holds its shape even when softened.
Coconut, to toast, 110 mL (1/2 cup)	P10(HIGH)	1 1/2 to 2	Place in a pie plate or bowl. Stir every minute.
Cream Cheese, to soften, 230 g (8 oz)	P3(MEDIUM-LOW)	1 1/2 to 2	Remove the wrapper and place in a microwave-safe dish.
Dried Fruits, to soften	P10(HIGH)	20 to 30 seconds	Place fruit in a small bowl and sprinkle with water. Cover with plastic wrap.
Frozen Pie, cooked slice whole pie	P10(HIGH) P6(MEDIUM)	2 to 4 18 to 20	Place on a plate. Elevate on an inverted pie plate.
Ice Cream Topping, to warm	P10(HIGH)	30 to 45 seconds	Place 1 cup of topping in a dish; stir twice..
Ice Cream, to soften, 2 L (8 cups)	P3(MEDIUM-LOW)	1 to 1 1/2	Check often to prevent melting.
Nuts, to roast, 375 mL (1 1/2 cups)	P10(HIGH)	4 to 5	Spread nuts in a 23 cm (9") pie plate. Stir every minute.
Sesame Seeds, to toast, 50 mL (1/4 cup)	P10(HIGH)	1 1/2 to 2	Place in a small bowl. Stir once every minute.
Syrup / Honey, to soften	P10(HIGH)	20 to 30 seconds	Uncover the container. Stir or shake once. May be repeated if still crystalline.
Tostada, Tortillas, Taco Shells, to soften	P10(HIGH)	20 to 40 seconds	Place 4 shells between damp paper towels.
Warm Pastry, Rolls	P10(HIGH)	10 to 15 seconds	Place on a rack or wrap in a paper towel.
Liquids: (For Soup / Beverages) Water 250 mL (8 oz) 500 mL (16 oz) Milk / Soup 250 mL (8 oz) 500 mL (16 oz)	P10(HIGH) P10(HIGH) P7(MEDIUM-HIGH) P7(MEDIUM-HIGH)	2 1/2 to 3 5 to 5 1/2 2 to 3 4 to 5	Heated liquids can erupt if not mixed with air. Do not heat liquids in your microwave oven without stirring first.
Hot Compress	P10(HIGH)	15 seconds	Wet a cotton wash cloth; fold and heat.
Remove Oven Odours	P10(HIGH)	5	Combine 250 mL (1 cup) water with the juice and peel of one lemon in a measuring cup. After heating, wipe interior of oven with a damp cloth.



# Before Requesting Service

## All these things are normal:

The oven causes interference with my TV.

Some radio and TV interference might occur when you cook with the microwave oven. This interference is similar to the interference caused by small appliances such as mixers, vacuums, blow dryers, etc. It does not indicate a problem with your oven.

Steam accumulates on the oven door and warm air comes from the oven vents.































During cooking, steam and warm air are given off from the food. Most of the steam and warm air are removed from the oven by the air which circulates in the oven cavity. However, some steam will condense on cooler surfaces such as the oven door. This is normal.

I accidentally ran my microwave oven without any food in it.

Running the oven empty for a short time will not damage the oven. However, we do not recommend operating the microwave oven without any food in it.

PROBLEM	POSSIBLE CAUSE	ACTION
Oven will not turn on.	The oven is not plugged in securely.	Remove plug from outlet, wait 10 seconds and reinsert.
	Circuit breaker or fuse is tripped or blown.	Reset circuit breaker or replace fuse.
	There is a problem with the outlet.	Plug another appliance into the outlet to check if it is working.
Oven will not start cooking.	The door is not closed completely.	Close the oven door securely.
	<b>Start</b> Pad was not pressed after programming.	Press <b>Start</b> Pad.
	Another program is already entered into the oven.	Press <b>Stop/Reset</b> Pad to cancel the previous program and enter a new program.
	The program is not correct.	Program again according to the Operating Instructions.
	<b>Stop/Reset</b> Pad has been pressed accidentally.	Program oven again.
The Glass Tray wobbles.	The Glass Tray is not positioned properly on the Roller Ring(s) or there is food under the Roller Ring(s).	Take out Glass Tray and Roller Ring(s). Wipe with a damp cloth and reset Roller Ring(s) and Glass Tray properly.
When the oven is operating, there is noise coming from the Glass Tray.	The Roller Ring(s) and oven bottom are dirty.	Clean according to Care of Your <b>Microwave Oven</b> .

# Quick Guide to Operation

Feature	How to Operate		
To Set <b>Clock</b> (☛ page 7)	 Press.	 Enter time of day.	 Press.
Power and Time Setting (☛ page 7)	 Select power.	 Enter cook time.	 Press.
To Cook using <b>Quick Min</b> (☛ page 10)	 Tap desired number of times (up to 10).	 Press.	
To Defrost using Manual Defrost (☛ page 7)	 Press 8 times to select P3.	 Enter defrosting time.	 Press.
Inverter Turbo Defrost (☛ page 8)	 Press.	 Enter weight.	 Press.
To Reheat using <b>Auto Reheat</b> (☛ page 9)	 Select serving (1-4).	 Press.	
To Cook using <b>Popcorn</b> (☛ page 8)	 Press to select weight.	 Press.	
To Use as a <b>Timer</b> (☛ page 10)	 Press.	 Enter time.	 Press.
To Set Standing time (☛ page 10)	(Input up to 4-stage Cooking Program.)	 Press.	 Enter time.
To Set Delay time (☛ page 10)	 Press.	 Enter time.	(Input up to 4-stage Cooking Program.)  Press.
To Cook using <b>Auto Cook Pads</b> (☛ page 9)	e.g. Potatoes  Press desired category.	 Press to select weight.	 Press.
To Use Child Safety Lock (☛ page 8)	 To Set: Press 3 times.	 To Cancel: Press 3 times.	