

This Owner's Manual is provided and hosted by [Appliance Factory Parts](#).

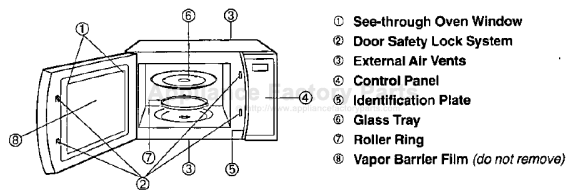

# PANASONIC NN-S547 Owner's Manual

[Shop genuine replacement parts for PANASONIC  
NN-S547](#)



[Find Your PANASONIC Microwave Parts - Select From 742 Models](#)

----- Manual continues below -----

# Panasonic®

## Operating Instructions

Microwave Oven

Model NN-S657/NN-S647/NN-S557/NN-S547



This manual contains Safety Instructions, Operating Instructions and Maintenance of the oven.  
For Cooking Guide and parts information, see page 11.  
Before operating this oven, please read these instructions completely.

Thank you for purchasing the Panasonic Microwave Oven.  
Please read the instructions completely.  
Let's Start to Use Your Oven! — page 8

## **PRECAUTIONS TO AVOID POSSIBLE EXPOSURE TO EXCESSIVE MICROWAVE ENERGY**

- (a) Do not attempt to operate this oven with the door open since open-door operation can result in harmful exposure to microwave energy. It is important not to defeat or tamper with the safety interlocks.
- (b) Do not place any object between the oven front face and the door, or allow soil or cleaner residue to accumulate on sealing surfaces.
- (c) Do not operate the oven if it is damaged. It is particularly important that the oven door close properly and that there is no damage to the:
  - (1) door (bent)
  - (2) hinges and latches (broken or loosened)
  - (3) door seals and sealing surfaces.
- (d) The oven should not be adjusted or repaired by anyone except properly qualified service personnel.

**STAPLE YOUR STORE RECEIPT HERE.**

The serial number of this product may be found on the right side of the oven door opening. You should note the model number and the serial number of this oven in the space provided and retain this book as a permanent record of your purchase for future reference.

**Model No.** \_\_\_\_\_

**Serial No.** \_\_\_\_\_

**Date of Purchase** \_\_\_\_\_

# CONTENTS

## Before Operating

|                                    |                    |
|------------------------------------|--------------------|
| Precautions.....                   | Inside Front Cover |
| Important Safety Instructions..... | 2                  |
| Installation Instructions.....     | 3                  |
| Grounding Instructions.....        | 3                  |
| Practical Hints.....               | 4                  |
| Cookware and Utensil Guide.....    | 5                  |
| Food Characteristics.....          | 6                  |
| Cooking Techniques.....            | 6                  |
| Feature Diagram.....               | 7                  |
| Control Panels.....                | 7                  |

## Operation

|  |            |
|--|------------|
| Let's Start to Use Your Oven!.....           | 8          |
| To Set Clock.....                            | 8          |
| To Use Popcorn Pad.....                      | 8          |
| Child Safety Lock.....                       | 8          |
| To Set Timer (Stand Time/Delay Start).....   | 9          |
| To Reheat using Power and Time Setting.....  | 9          |
| Auto Reheat Pad.....                         | 10         |
| To Defrost using Power and Time Setting..... | 9          |
| Auto Defrost Pad.....                        | 10         |
| To Cook using Power and Time Setting.....    | 9          |
| Convenience Codes.....                       | 11         |
| Auto Cook Pad.....                           | 11         |
| To Use Quick Min Pad.....                    | 10         |
| Microwave Shortcuts.....                     | 12         |
| Quick Guide to Operation.....                | Back Cover |

## Maintenance

|  |       |
|--|-------|
| To Order Accessories, Books, etc. .... | 11    |
| Care of Your Microwave Oven.....       | 13    |
| Before Requesting Service.....         | 13    |
| Technical Specifications.....          | Below |

## Technical Specifications

|  | NN-S657  | NN-S647  | NN-S557   | NN-S547        |
|--|--|--|---|----------------|
| Power Consumption:                     | 13.5 A, 1550 W   | 11.7 A, 1350 W   | 13.5 A, 1550 W  | 11.7 A, 1350 W |
| Output:*                               | 1000 W   | 850 W  | 1000 W  | 850 W          |
| Outside Dimensions<br>(H x W x D):     | 12" x 21 $\frac{1}{8}$ " x 16 $\frac{3}{4}$ "<br>(306mm x 555mm x 425mm)               | 12" x 21 $\frac{1}{8}$ " x 16 $\frac{3}{4}$ "<br>(306mm x 555mm x 425mm)               | 12" x 20" x 14 $\frac{3}{8}$ "<br>(306mm x 510mm x 360mm)               |                |
| Oven Cavity Dimensions<br>(H x W x D): | 8 $\frac{5}{8}$ " x 14 $\frac{3}{4}$ " x 15 $\frac{5}{8}$ "<br>(220mm x 375mm x 395mm) | 8 $\frac{5}{8}$ " x 14 $\frac{3}{4}$ " x 15 $\frac{5}{8}$ "<br>(220mm x 375mm x 395mm) | 9" x 13 $\frac{1}{2}$ " x 13 $\frac{1}{8}$ "<br>(229mm x 353mm x 338mm) |                |
| Operating Frequency:                   | 2,450MHz   | 2,450MHz   | 2,450MHz  |                |
| Uncrated Weight:                       | Approx. 38 lbs. (17.2 kg)  | Approx. 38 lbs. (17.2 kg)  | Approx. 34 lbs. (15.3 kg)   |                |

\*IEC 705-88 Test procedure  
Specifications subject to change without notice.

# IMPORTANT SAFETY INSTRUCTIONS

Your microwave oven is a cooking device and you should use as much care as you use with a stove or any other cooking device.

When using this electric appliance, basic safety precautions should be followed, including the following:

**WARNING**—To reduce the risk of burns, electric shock, fire, injury to persons or exposure to excessive microwave energy:

- (d) Do not use the cavity for storage purposes. Do not leave paper products, cooking utensils, or food in the cavity when not in use.

1. Read all instructions before using the appliance.
2. Read and follow the specific **"PRECAUTIONS TO AVOID POSSIBLE EXPOSURE TO EXCESSIVE MICROWAVE ENERGY,"** found on back of the front cover.
3. This appliance must be grounded. Connect only to properly grounded outlet. See **"GROUNDING INSTRUCTIONS"** found on page 3.
4. Install or locate this appliance only in accordance with the Installation Instructions found on page 3.
5. Do not cover or block any openings on this appliance.
6. Do not store or use this appliance outdoors. Do not use this product near water—for example, near a kitchen sink, in a wet basement, or near a swimming pool, and the like.
7. Use this appliance only for its intended use as described in this manual. Do not use corrosive chemicals or vapors in this appliance. This type of oven is specifically designed to heat, or cook food. It is not designed for industrial or laboratory use.
8. When cleaning surfaces of door and oven that come together on closing the door, use only mild, non-abrasive soaps or detergents applied with a sponge or soft cloth.
9. As with any appliance, close supervision is necessary when used by children.
10. Do not operate this appliance if it has a damaged cord or plug, if it is not working properly, or if it has been damaged or dropped.
11. Do not immerse cord or plug in water.
12. Keep cord away from heated surfaces.
13. Do not let cord hang over edge of table or counter.
14. This appliance should be serviced only by qualified service personnel. Contact the nearest authorized service facility for examination, repair or adjustment.
15. Some products such as whole eggs and sealed containers—for example, closed glass jars—may explode and should not be heated in this oven.
16. To reduce the risk of fire in the oven cavity:
  - (a) Do not overcook food. Carefully attend appliance if paper, plastic, or other combustible materials are placed inside the oven to facilitate cooking.
  - (b) Remove wire twist-ties from paper or plastic bags before placing bag in oven.
  - (c) If materials inside the oven should ignite, keep oven door closed, turn oven off, and disconnect the power cord, or shut off power at the fuse or circuit breaker panel.

## General Use

1. **Do NOT** tamper with or make any adjustments or repairs to door, control panel housing, safety interlock switches or any other part of the oven. **Do NOT** remove outer panel from oven. Repairs should only be done by a qualified service person.

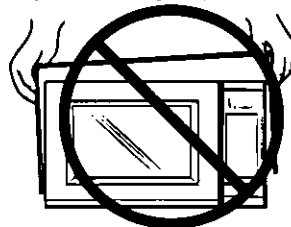

2. **Do NOT** operate the oven empty. The microwave energy will reflect continuously throughout the oven if food or water is not present to absorb energy. This could damage the oven and result in the danger of a fire.

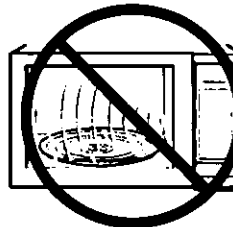

3. **Do NOT** use this oven to heat chemicals or other non-food products. **Do NOT** clean this oven with any product that is labeled as containing corrosive chemicals. **The heating of corrosive chemicals in this oven can cause radiation leaks.**
4. **Do NOT** dry clothes, newspapers or other materials in oven. They may catch fire.
5. **Do NOT** use recycled paper products unless the paper product is labeled safe for microwave oven use. Recycled paper products may contain impurities which may cause sparks and/or fires when used.
6. **Do NOT** use newspapers or paper bags for cooking. Fire can result.
7. **Do NOT** hit or strike control panel. Damage to controls may occur. Fire can result.
8. **POT HOLDERS** may be needed when cooking. Heat is transferred from the **hot** food to the cooking container and from the cooking container to the Glass Tray. Glass Tray can be very **hot** after removing cooking container from oven.
9. **Do NOT** store flammable materials next to, on top of, or in the oven. These could be fire hazards.

## SAVE THESE INSTRUCTIONS

For proper use of your oven read remaining safety cautions and operating instructions.

# INSTALLATION & GROUNDING INSTRUCTIONS

## Examine Your Oven

Unpack oven, remove all packing material, and examine the oven for any damage such as dents, broken door latches or cracks in the door. Notify dealer immediately if oven is damaged. **Do NOT** install if oven is damaged.

## Placement of Oven

- Oven must be placed on a flat, stable surface. For proper operation, the oven must have sufficient air flow. Allow 3 inches (8 cm) of space on both sides of the oven and 1 inch (2.5 cm) of space on top of oven.
  - Do NOT** block air vents.  
If they are blocked during operation, the oven may overheat. If the oven overheats, a thermal safety device will turn the oven off. The oven will remain inoperable until it has cooled.
  - Do NOT** place oven near a hot damp surface such as a gas or electric range.
  - Do NOT** operate oven when room humidity is too high.
- This oven was manufactured for household use only.

## Grounding Instructions

This appliance must be grounded. In the event of an electrical short circuit, grounding reduces the risk of electric shock by providing an escape wire for the electric current. This appliance is equipped with a cord having a grounding wire with a grounding plug. The plug must be plugged into an outlet that is properly installed and grounded.

**WARNING**—Improper use of the grounding plug can result in a risk of electric shock.

Consult a qualified electrician or service person if the grounding instructions are not completely understood, or if doubt exists as to whether the appliance is properly grounded.

If it is necessary to use an extension cord, use only a three wire extension cord that has a three blade grounding plug, and a three slot receptacle that will accept the plug on the appliance. The marked rating of the extension cord should be equal to or greater than the electrical rating of the appliance.

## Power Supply

- A short power-supply cord is provided to reduce the risks resulting from becoming entangled in or tripping over a longer cord.
- Longer cord sets or extension cords are available and may be used if care is exercised in their use.
- If a long cord or extension cord is used, (1) the marked electrical rating of the cord set or extension cord should be at least as great as the electrical rating of the appliance, (2) the extension cord must be a grounding-type 3-wire cord, and (3) the longer cord should be arranged so that it will not drape over the countertop or tabletop where it can be pulled on by children or tripped over accidentally.

## Wiring Requirements

- The oven must be on a **SEPARATE CIRCUIT**. No other appliance should share the circuit with the microwave oven. If it does, the branch circuit fuse may blow, or the circuit breaker may trip or the food may cook slower than the times recommended in this manual.
- The **VOLTAGE** used must be the same as specified on this microwave oven (120V). Using a higher voltage is dangerous and may result in a fire or other accident causing oven damage. Using a lower voltage will cause slow cooking. Panasonic is **NOT** responsible for damage resulting from the use of the oven with other than specified voltage.
- The oven must be plugged into at least a 15 AMP 120 VOLT, 60 Hz **GROUNDING OUTLET**.

Where a standard two-prong outlet is encountered, it is the personal responsibility and obligation of the consumer to have it replaced with a properly grounded three-prong outlet.



- A **TEMPORARY CONNECTION** with a two-prong adapter may be made where **LOCAL CODES PERMIT** it. Unless the cover screw is grounded through the house wiring, attaching the adapter grounding plate to the cover screw will not ground the oven. If there is any doubt that the cover screw is grounded, have it checked by an electrician.

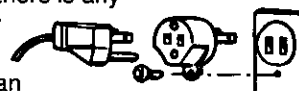

## Radio Interference

- Operation of the microwave oven may cause interference to your radio, TV or similar equipment.
- When there is interference, it may be reduced or eliminated by taking the following measures:
  - Clean door and sealing surfaces of the oven. (See Care of Your Microwave Oven on p. 13.)
  - Place the radio, TV, etc. away from the microwave oven as far as possible.
  - Use a properly installed antenna to obtain stronger signal reception.

## Follow These Safety Precautions When Cooking in Your Oven

### 1) HOME CANNING / DRYING FOODS / SMALL QUANTITIES OF FOODS

- Do not use your oven for home canning or the heating of any closed jar. Pressure will build up and the jar may explode. Your oven cannot maintain the food at the proper canning temperature. Improperly canned food may spoil and be dangerous to consume.
- Small quantities of food or foods with low moisture content can dry out, burn or catch on fire.
- Do not dry meats, herbs, fruits or vegetables in your oven.

### IMPORTANT

Proper cooking depends on time set and weight of food. If you use a smaller portion than recommended and cook at the time for the recommended portion, fire can result.

If a fire occurs, turn the oven off and leave the oven door closed. Disconnect the power cord or shut off power at the fuse or circuit breaker panel.

### 2) POPCORN

Popcorn must be popped in a microwave oven corn popper. Microwave popcorn which pops in its own package is also available. Follow popcorn manufacturers' directions and use a brand suitable for the wattage of your microwave oven. Never leave oven unattended when popping popcorn. Allow the popcorn bag to cool before opening it. To prevent steam burns, always open the bag away from your face and body.

#### CAUTION:

When using pre-packaged microwave popcorn, follow recommended package instructions. Check package weight before using the popcorn pad. Set the oven for the weight of the popcorn package. (see page 8) If these instructions are not followed, the popcorn may not pop adequately or may ignite and cause a fire.

### 3) DEEP FAT FRYING

- Do not attempt to deep fat fry in your microwave oven. Cooking oils may burst into flames and may cause damage to the oven and perhaps result in burns. Microwave utensils may not be able to withstand the temperature of the hot oil, and could shatter.

### 4) EGGS

- Do not heat eggs in their shell in a microwave oven. Pressure will build up and the eggs will explode.

### 5) FOODS WITH NONPOROUS SKINS

- Potatoes, apples, egg yolks, whole squash and sausages are examples of foods with nonporous skins. These types of foods must be pierced before microwave cooking to prevent their bursting.
- Use fresh potatoes for baking and cook until just done. Overcooking causes dehydration and may cause a

fire. Use recommended weights or fire may occur.

### 6) LIQUIDS

- Heated liquids can erupt if not mixed with air. Do not heat liquids in your microwave oven without first stirring.

### 7) GLASS TRAY / COOKING UTENSILS / FOIL

- Cooking utensils get hot during microwaving. Use potholders when removing utensils from the oven or when removing lids or plastic wrap covers from cooking utensils to avoid burns.
- The glass tray will get hot during cooking. It should be allowed to cool before handling or before paper products, such as paper plates or microwave popcorn bags, are placed in the oven for microwave cooking.
- When using foil, skewers, warming rack or utensils made of metal in the oven, allow at least 1-inch of space between metal material and interior oven walls. If arcing occurs (sparking) remove metal material (skewers etc.) and/or transfer to a non-metallic container.
- Dishes with metallic trim should not be used, as arcing may occur.

### 8) PAPER TOWELS / CLOTHS

- Do not use paper towels or cloths which contain a synthetic fiber woven into them. The synthetic fiber may cause the towel to ignite.
- Do not use paper bags or recycled paper products in the microwave oven.

### 9) BROWNING DISHES / OVEN COOKING BAGS

- Browning dishes or grills are designed for microwave cooking only. Always follow instructions provided by the manufacturer. Do not preheat browning dish more than 8 minutes.
- If an oven cooking bag is used for microwave cooking, prepare according to package directions. Do not use a wire twist-tie to close bag.

### 10) THERMOMETERS

- Do not use a conventional meat thermometer in your oven. Arcing may occur.

### 11) BABY FORMULA / FOOD

- Do not heat baby formula or food in the microwave oven. The glass jar or surface of the food may appear warm while the interior can burn the infant's mouth and esophagus.

### 12) REHEATING PASTRY PRODUCTS

- When reheating pastry products, check temperature of any fillings before eating. Some foods have fillings which heat faster and can be extremely hot while the surface remains warm to the touch (ex. jelly donuts).

### 13) GENERAL OVEN USAGE GUIDELINES / OVEN DOOR

- Do not use the oven for any reason other than the preparation of food.
- Do not leave oven unattended while in use.

# Cookware and Utensil Guide

| ITEM  | MICROWAVE              | COMMENTS  |
|---|------------------------|---|
| Aluminum Foil   | Yes for Shielding only | Small strips of foil can be molded around thin parts of meat or poultry to prevent overcooking. Arcing can occur if foil is too close to oven wall or if too much foil is used.   |
| Browning Dish   | Yes                    | Browning dishes are designed for microwave cooking only. Check browning dish information for instructions and heating chart. Do not preheat for more than 8 minutes.  |
| Brown paper bags  | No                     | May cause a fire in the oven.   |
| Dinnerware Microwave-Safe only                            | Yes                    | Check manufacturers' use and care directions for suitability for microwave heating. Some dinnerware may state on the back of the dish, "Oven-Microwave Proof."  |
| Disposable polyester Paperboard Dishes                    | Yes                    | Some frozen foods are packaged in these dishes. Can be purchased in grocery stores.   |
| Fast Food Carton with Metal Handle                        | No                     | May cause arcing.   |
| Frozen Dinner Tray Metal                                  | Yes                    | Frozen dinners may be heated in foil tray, if tray is less than ¾-inch (2 cm) high. Place foil tray in center of oven. Leave at least 1-inch (2.5 cm) space between foil tray and oven walls. Heat only 1 foil tray in the oven at a time. For containers more than ¾-inch (2 cm) deep, remove food and place in a similar size microwave-safe container. |
| Microwave-safe  | Yes                    |   |
| Glass Jars  | Yes                    | Remove lid. Heat food until just warm. Most glass jars are not heat resistant.  |
| Glassware Heat Resistant Oven Glassware and Ceramic, only | Yes                    | Ideal for microwave cooking and browning.   |
| Metal Twist Ties  | No                     | May cause arcing which could cause a fire in the oven.  |
| Oven Cooking Bag  | Yes                    | Follow manufacturers' directions. Close bag with the nylon tie provided, a strip cut from the end of the bag, or a piece of cotton string. Do not close with metal twist tie. Make six ½-inch (1 cm) slits by closure.  |
| Paper Plates & Napkins                                    | Yes                    | Use to warm cooked foods, and to cook foods that require short cooking times such as hot dogs.  |
| Paper Towels & Napkins                                    | Yes                    | Use to warm rolls and sandwiches by microwave.  |
| Plastic Microwave-Safe only Cookware and Storage Dishes   | Yes                    | Should be labeled, "Suitable for microwave heating." Check manufacturers' directions for recommended uses. Some microwave-safe plastic dishes are not suitable for cooking foods with high fat content.   |
| Plastic Foam Cups   | Yes                    | Plastic foam will melt if foods reach a high temperature. Use to bring foods to a low serving temperature.  |
| Plastic Wrap, Microwave                                   | Yes                    | Use to cover food during cooking to retain moisture.  |
| Straw, Wicker, Wood                                       | Yes                    | Use only for short term reheating. Use to bring foods to a low serving temperature.   |
| Thermometers Microwave-safe only                          | Yes                    | Use only microwave-safe meat and candy thermometers. Not suitable for use in microwave oven.  |
| Conventional  | No                     |   |
| Wax paper   | Yes                    | Use as a cover to prevent spattering and to retain moisture.  |

**TO TEST A CONTAINER FOR SAFE MICROWAVE OVEN USE:** Fill a 1 -cup glass measure with water and place it in the microwave oven along with the container to be tested; **heat one minute at HIGH**. If the container is microwave oven-safe, it should remain comfortably cool and the water should be hot. If the container is hot, it has absorbed some microwave energy and should not be used. This test cannot be used for plastic containers.



# Food Characteristics

**Bone and Fat:** Both bone and fat affect cooking. Bones may cause irregular cooking. Meat next to the tips of bones may overcook while meat positioned under a large bone, such as a ham bone, may be undercooked. Large amounts of fat absorb microwave energy and the meat next to these areas may overcook.

**Density:** Porous, airy foods such as breads, cakes or rolls take less time to cook than heavy, dense foods such as potatoes and roasts.

**Quantity:** Two potatoes take longer to cook than one potato. As the quantity of the food increases so does the cooking time.

When cooking small amounts of food such as one

or two potatoes, do not leave oven unattended. The moisture content in the food may decrease and a fire could result.

**Shape:** Uniform sizes heat more evenly. The thin end of a drumstick will cook more quickly than the meaty end. To compensate for irregular shapes, place thin parts toward the center of the dish and thick pieces toward the edge.

**Size:** Thin pieces cook more quickly than thick pieces.

**Starting Temperature:** Foods that are room temperature take less time to cook than if they are refrigerator temperature or frozen.

# Cooking Techniques

**Spacing:** Individual foods, such as baked potatoes, cupcakes and appetizers, will cook more evenly if placed in the oven equal distances apart. When possible, arrange foods in a circular pattern.

**Browning:** Foods will not have the same brown appearance as conventionally cooked foods. Meats and poultry may be coated with browning sauce, Worcestershire sauce, barbecue sauce or shake-on browning sauce. To use, combine browning sauce with melted butter or margarine; brush on before cooking.

**Piercing:** Foods with skins or membranes must be pierced, scored or have a strip of skin peeled before cooking to allow steam to escape. Pierce whole egg yolks and whites, clams, oysters, chicken livers, whole potatoes and whole vegetables. Whole apples or new potatoes should have a 1-inch strip of skin peeled before cooking. Score sausage, frankfurters and hot dogs.

**Covering:** As with conventional cooking, moisture evaporates during microwave cooking. Casserole lids or plastic wrap are used for a tighter seal. When using plastic wrap, vent the plastic wrap by folding back part of the plastic wrap from the edge of the dish to allow steam to escape. Loosen or remove plastic wrap as recipe directs for stand time. When removing plastic wrap covers, as well as any glass lids, be careful to remove them away from you to avoid steam burns. Various degrees of moisture retention are also obtained by using wax paper or paper towels. However, unless specified, a recipe is cooked uncovered.

**Shielding:** Thin areas of meat and poultry cook more quickly than meaty portions. To prevent overcooking, these thin areas can be shielded with strips of aluminum foil. Wooden toothpicks may be used to hold the foil in place.

**Timing:** A range in cooking time is given in each recipe. The time range compensates for the uncontrollable differences in food shapes, starting temperature and regional preferences. Always cook food for the minimum cooking time given in the recipe and check for doneness. If the food is undercooked, continue cooking. It is easier to add time to an undercooked product. Once the food is overcooked, nothing can be done.

**Stirring:** Stirring is usually necessary during microwave cooking. We have noted when stirring is helpful, using the words once, twice, frequently or occasionally to describe the amount of stirring necessary.

**Rearranging:** Rearrange small items such as chicken pieces, shrimp, hamburger patties or pork chops. Rearrange pieces from the edge to the center and pieces from the center to the edge of the dish.

**Turning:** It is not possible to stir some foods to redistribute the heat. At times microwave energy will concentrate in one area of a food. To help insure even cooking, these foods need to be turned. Turn over large foods, such as roasts or turkeys, halfway through cooking.

**Standing Time:** Most foods will continue to cook by conduction after the microwave oven is turned off. In meat cookery, the internal temperature will rise 5°F to 15°F if allowed to stand, tented with foil, for 10 to 15 minutes. Casseroles and vegetables need a shorter amount of standing time, but this standing time is necessary to allow foods to complete cooking in the center without overcooking on the edges.

**Testing for Doneness:** The same tests for doneness used in conventional cooking may be used for microwave cooking. Meat is done when fork-tender or splits at fibers. Chicken is done when juices are clear yellow and drumstick moves freely. Fish is done when it flakes and is opaque.

# Feature Diagram

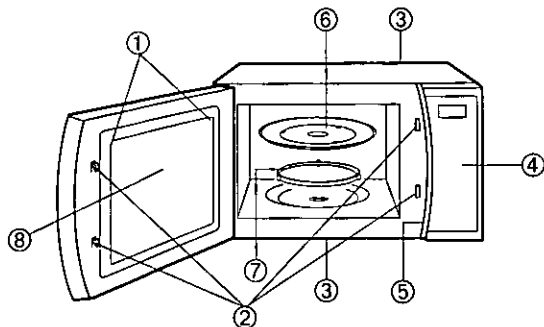

- ① See-through Oven Window
- ② Door Safety Lock System
- ③ External Air Vents
- ④ Control Panel
- ⑤ Identification Plate
- ⑥ Glass Tray
- ⑦ Roller Ring
- ⑧ Vapor Barrier Film (do not remove)

## Control Panels

NNS657/NNS557

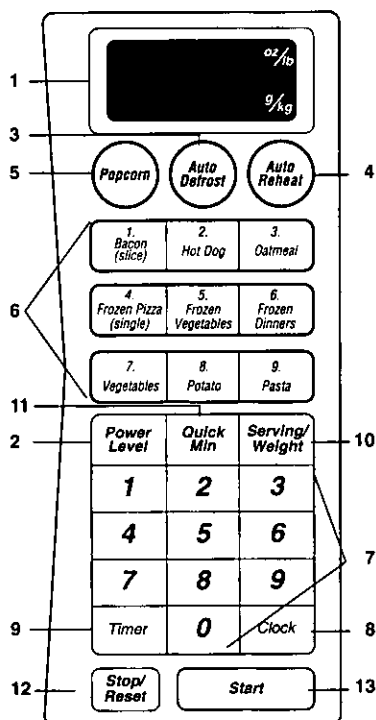

- (1) **Display Window**  
This oven displays weight in oz/lb or in g/kg. Press **Start** Pad immediately to select the system you desire. The indicator appears to select the system.
- (2) **Power Level Pad** (☛ page 9)
- (3) **Auto Defrost Pad** (☛ page 10)
- (4) **Auto Reheat Pad** (☛ page 10)
- (5) **Popcorn Pad** (☛ page 8)
- (6) **Auto Cook Pad(s)** (☛ page 11)
- (7) **Number Pads**
- (8) **Clock Pad** (☛ page 8)
- (9) **Timer Pad** (☛ page 9)
- (10) **Serving/Weight Pad** (☛ page 11)
- (11) **Quick Min** (☛ page 10)

NNS647/NNS547

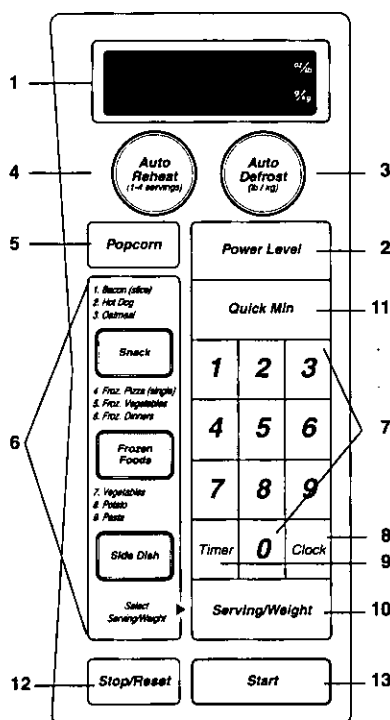

- (12) **Stop Reset Pad**  
**Before cooking:** One tap clears your instruction.  
**During cooking:** One tap temporarily stops the cooking process. Another tap cancels all your instructions and time of day or colon appears on the screen.
- (13) **Start Pad**  
One tap allows oven to begin functioning. If door is opened or **Stop/Reset** Pad is pressed once during oven operation, **Start** Pad must again be pressed to restart oven.

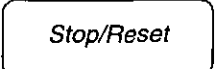

# Let's Start to Use Your Oven!

|   |   |
|---|---|
| <p>1.</p>  | <ul style="list-style-type: none"> <li>• Plug in a properly grounded electrical outlet.</li> <li><b>lb/kg Conversion:</b> The oven automatically displays the lbs/oz symbol when using Auto Defrost feature etc.</li> <li><u>If you wish to use the kg/g</u>, press <b>Start</b> Pad immediately after the oven is plugged in. An indicator will move to the selected weight system.</li> </ul> |
| <p>2.</p>  | <ul style="list-style-type: none"> <li>• Press <b>Stop/Reset</b> Pad to delete "88.88" indication. Now, you may set the clock (see below).</li> </ul>   |

## To Set Clock

You can use the oven without setting the clock.

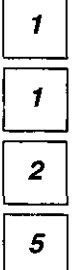
**Example: To set 11:25**

|  |  |
|--|--|
| <p>1.</p>   | <ul style="list-style-type: none"> <li>• Press.</li> <li>▶ Dot will blink.</li> </ul>  |
| <p>2.</p>   | <ul style="list-style-type: none"> <li>• Enter time of day using the number pads.</li> <li>▶ Time appears on the screen; dot is blinking.</li> </ul> |
| <p>3.</p>  | <ul style="list-style-type: none"> <li>• Press.</li> <li>▶ Dot stops blinking; time of day is entered and locked onto the screen.</li> </ul>         |

### NOTES:

1. To reset time of day, repeat step 1 through step 3.
2. The clock will keep the time of day as long as oven is plugged in and electricity is supplied.
3. Clock is a 12-hour display.

## Child Safety Lock

This feature prevents the electronic operation of the oven until cancelled. It does **not** lock the door.

### To Set:

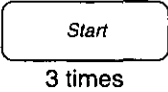
|   |  |
|---|--|
| <p>1.</p>  | <ul style="list-style-type: none"> <li>• Press 3 times.</li> <li>▶ "CHILD" appears on the screen.</li> </ul> |
|---|--|

### To Cancel:

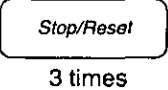
|   |   |
|---|---|
| <p>1.</p>  | <ul style="list-style-type: none"> <li>• Press 3 times.</li> <li>▶ Time of day or dot appears on the screen.</li> </ul> |
|---|---|

## To Use Popcorn Pad

**Example: To heat 3.5 oz. of prepackaged microwave popcorn**

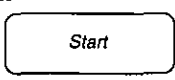
|   |  |
|---|--|
| <p>1.</p>  <p>Press once</p> | <ul style="list-style-type: none"> <li>• Set the desired weight of prepackaged microwave popcorn. (3.5 oz., 3.0 oz. or 1.75 oz.)</li> </ul>          |
| <p>2.</p>                    | <ul style="list-style-type: none"> <li>• Press <b>Start</b> Pad.</li> <li>▶ Cooking time appears in the display and begins to count down.</li> </ul> |

### NOTES ON POPCORN PAD:

1. Use prepackaged room temperature microwave popcorn. Read manufacturers' instructions.
2. Place bag in oven according to manufacturers' directions.
3. Pop only one bag at a time.
4. After popping, open bag carefully, popcorn and steam are extremely hot.
5. Do not reheat unpopped kernels or reuse bag.
6. The recommended weights are already programmed in the memory.
7. **Never** leave oven unattended when popping popcorn.

| Press Pad | Weight         |
|-----------|----------------|
| once      | 3.5 oz. (99g)  |
| twice     | 3.0 oz. (90g)  |
| 3 times   | 1.75 oz. (50g) |



### CAUTION:

If pre-packaged popcorn is of a different weight than those on the chart, do not use the popcorn setting, or inadequate popping or a fire may occur. Follow the manufacturers' instructions.

# Power & Time Setting

How do I program Power and Time?

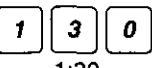
**Example: To cook at MEDIUM Power for 1 minute 30 seconds**

|   |   |
|---|---|
| 1. <br>Med = 4 times | • Select <b>Power Level</b> .<br>(according to the chart below)   |
| 2. <br>1:30          | • Set Cooking Time using number pads.<br>(up to 99 minutes and 99 seconds for a single stage)   |
| 3.                    | • Press.<br>▶Cooking will start. The time on the screen will count down.<br><b>To recall the selected power level, press Power Level Pad at any time.</b> |

| Press   | Power Level        | % Power |
|---------|--------------------|---------|
| once    | P100 (HIGH)        | 100%    |
| twice   | dEF (DEFROST)      | 30%     |
| 3 times | P 70 (MEDIUM-HIGH) | 70%     |
| 4 times | P 50 (MEDIUM)      | 50%     |
| 5 times | P 30 (MEDIUM-LOW)  | 30%     |
| 6 times | P 10 (LOW)         | 10%     |



## NOTES:

- For 2 or 3 stage cooking, repeat steps 1 and 2 above before pressing **Start** Pad.
- When selecting HIGH Power on the first stage, you can start from step 2.
- Two beeps will sound between each stage of programming. Five beeps will sound at the end of the sequence.
- For reheating, use Medium High (P70).

# To Set Timer (cont.)

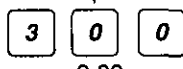

## To Set Standing Time:

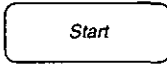
**Example: To stand for 5 minutes after cooking (3 mins. at MEDIUM Power)**

|   |  |
|---|--|
| 1. <br>Med = 4 times<br>↓<br><br>3:00 | • Set the desired cooking program (power level and time).  |
| 2.   | • Press <b>Timer</b> Pad.  |
| 3. <br>5:00  | • Set desired amount of Stand Time using number pads.<br>(up to 99 minutes and 99 seconds)                             |
| 4.   | • Press <b>Start</b> Pad.<br>▶Cooking will start. After cooking, standing time will count down without oven operating. |

## To Set Delay Start:

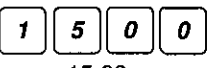
**Example: To delay the start of cooking (Med 3:00) for 15 mins. (3 mins. at MEDIUM Power)**

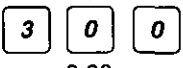
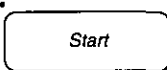
|   |  |
|---|--|
| 1.   | • Press <b>Timer</b> Pad.  |
| 2. <br>15:00   | • Set desired amount of delayed time using number pads.<br>(up to 99 minutes and 99 seconds) |
| 3. <br>Med = 4 times<br>↓<br><br>3:00 | • Set the desired cooking Program (power level and time).                                    |
| 4.   | • Press <b>Start</b> Pad.<br>▶Delayed time will count down. Then cooking will start.         |

## NOTES:

- If oven door is opened during the Standing Time or Kitchen Timer, the time in display window will continue to count down.
- Delay Start cannot be programmed before any Auto Control Function. This is to prevent the starting temperature of the food from rising before defrosting or cooking begins. A change in the starting temperature could cause inaccurate results.
- At the end of the entire sequence, you will hear 5 beeps.

# To Set Timer

This feature allows you to program a Standing Time after cooking is completed and to program the oven as a minute timer and/or to program a delay start.

## To Use as a Kitchen Timer:

**Example: To count 5 minutes**

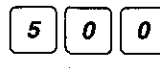
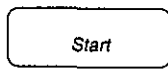
|  |  |
|--|--|
| 1.          | • Press <b>Timer</b> Pad.  |
| 2. <br>5:00 | • Set desired amount of time using number pads.<br>(up to 99 minutes and 99 seconds) |
| 3.           | • Press <b>Start</b> Pad.<br>▶Time will count down without oven operating.           |

# To Use Auto Reheat Pad

This feature allows you to reheat 1 to 4 servings of precooked room temperature and refrigerator temperature foods without setting power and time.

## Example: To reheat 2 cups of soup

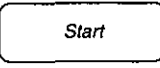
|   |   |
|---|---|
| 1. <br>2 times | • Press until the desired number of servings appears on the screen.       |
| 2.             | • Press<br>▶ Cooking time appears on the screen and begins to count down. |

### NOTE:

1. Auto Reheat can be programmed for 1 to 4 servings (*each serving is 4 oz.*).
2. The following are the recommended food items and approximate weights.

| Foods                | Number of Servings | Serving Size  | Starting Temp.  |
|----------------------|--------------------|---------------|-----------------|
| Plate of Food        | 3 - 4              | 12 - 16 oz.   | Refrig.         |
| Meat, Poultry        | 1 - 4              | 4 oz. ea.     | Refrig.         |
| Casseroles           | 1 - 4              | 4 - 16 oz.    | Refrig.         |
| Side Dishes          | 1 - 4              | 4 oz. ea.     | Refrig. or Room |
| Soups, Sauces, Gravy | 1 - 2              | 4 - 6 oz. ea. | Refrig. or Room |

### For best results follow these recommendations:

1. All foods must be previously cooked.
2. Foods should always be covered loosely with plastic wrap, wax paper or casserole lid.
3. All foods should have a covered stand time of 3 to 5 minutes.
4. **DO NOT** reheat bread and pastry products. Use manual power and time.
5. **DO NOT** reheat beverages.

# Quick Min Function

This feature helps you in programming your oven without pressing Number Pads and allows you to add extra cooking time easily.

## To Set Cooking Time:

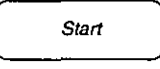
|  |  |
|--|--|
| 1.  | • Set cooking time (up to 10 taps/minutes)     |
| 2.  | • Press<br>▶ Cooking will start on HIGH power. |

### NOTE:

1. You can use other power levels, select the desired power level before setting the cooking time.
2. After setting the time by **Quick Min** Pad, you cannot use Number Pads, and vice versa.

# Quick Min Function (cont.)

## To Add Extra Cooking Time:

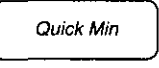
|   |  |
|---|--|
|  | • Press to add extra cooking time (up to 10 taps) during cooking.<br>▶ Cooking time changes to include extra time and continues to count down in the display window. |
|---|--|

**NOTE:** You can add cooking time during the program with power and time settings.

# To Use Auto Defrost Pad

This feature allows you to defrost meat, poultry and seafood by weight without setting time.

## Example: To defrost 1.5 pounds of meat

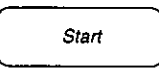
|  |   |
|--|---|
| 1.  | • Set the weight of the food. Weight must be programmed in pounds and tenths of a pound (not ounces) (see chart below). If you wish to use the kg/g., see page 8 (Let's Start to Use Your Oven!). |
| 2.  | • Press.<br>▶ Defrosting time appears on the screen and begins to count down.   |

### NOTE:

1. For best results, the minimum recommended weight is 0.5 pounds.
2. The shape and size of the food will determine the maximum weight the oven can accommodate. The recommended **maximum weight of meat is 4 lb.; poultry, 6 lb. and seafood, 3 lb.**
3. Stand time or power level may be programmed after Auto Defrost (see Stand Time on page 9).
4. The oven beeps once during the defrosting cycle to signal that the food needs to be turned or rearranged. To prevent overdefrosting, thin areas or edges can be shielded with strips of aluminum foil.

### Conversion Chart:

Follow this chart to convert ounces or hundredths of a pound into tenths of a pound. To use Auto Defrost, program the weight of the food in pounds (1.0) and tenths of a pound (0.1). If a piece of meat weighs 1.95 pounds or 1 pound 14 ounces, program 1.9 pounds. If a piece of meat weighs 1.99 pounds or 2 pounds 0 ounces, program 2.0 pounds.

| Ounces  | Hundredths of a Pound | Tenths of a Pound |
|---------|-----------------------|-------------------|
| 0       | .96 - .05             | 0.0               |
| 1 - 2   | .06 - .15             | 0.1               |
| 3 - 4   | .16 - .25             | 0.2               |
| 5       | .26 - .35             | 0.3               |
| 6 - 7   | .36 - .45             | 0.4               |
| 8       | .46 - .55             | 0.5               |
| 9 - 10  | .56 - .65             | 0.6               |
| 11 - 12 | .66 - .75             | 0.7               |
| 13      | .76 - .85             | 0.8               |
| 14 - 15 | .86 - .95             | 0.9               |

# Auto Cooking

This feature allows you to cook most of your favourite foods without setting power and time.

## 1 Select Recipe Pad (e.g. Potato)(NN-S657/S557)

## 2 Select Serving/Weight

## 3 Press Start

8



Serving / Weight



Start

Select the number of desired recipe by number pads.

(according to the chart below)

➤ Cooking time will appear in the display window and begin to count down.

## 1 Press Convenience Pads (NN-S647 / NN-S547)

## 2 Select Serving/Weight

## 3 Press Start

Snack

or

Froz. Foods

or

Side Dish



Serving / Weight



Start

Press desired category until recipe is displayed.

| RECIPE   | SERVING - WEIGHT                     | RECIPE  | SERVING - WEIGHT  |
|--|--------------------------------------|---|---|
| 1) Bacon (slice)<br><i>Use ridged dish, cover with paper towel</i> | 2, 3, 4, 6 slices                    | 7) Vegetables<br><i>Add water and cover with plastic wrap or lid.</i> | 4 oz./110 g<br>8 oz./225 g<br>12 oz./340 g<br>16 oz./450 g  |
| 2) Hot Dog <i>Pierce skin.</i>                                     | 1 - 4 pieces                         | 8) Potato (6 - 8 oz. each)<br><i>Pierce skin with fork.</i>           | 1 - 4 pieces  |
| 3) Oatmeal   | 1 - 2 servings                       | 9) Pasta<br><i>Cover with lid or plastic wrap.</i>                    | 2 oz./60 g<br>(2 cups of water)<br>4 oz./110 g<br>(3 cups of water)<br>6 oz./170 g<br>(4 cups of water)<br>8 oz./225 g<br>(5 cups of water) |
| 4) Frozen Pizza (single)<br><i>Follow directions on box.</i>       | 4 oz./110 g<br>8 oz./225 g           |   |   |
| 5) Frozen Vegetables   | 5, 10, 16 oz.<br>150 g, 300 g, 450 g |   |   |
| 6) Frozen Dinners  | 11 oz./300 g<br>15 oz./430 g         |   |   |

For more information regarding microwave cooking, order our new COOKING GUIDE.

| DESCRIPTION                              | PART NUMBER                 | PRICE   |
|--|-----------------------------|---------|
| Instruction/Operating Manual (this book) | B00039500AP                 | ①       |
| Cooking Guide                            | B000B8250AP                 | ①       |
| Glass Tray (see diagram on page 7)       | A06015690QP (NN-S557, S547) | \$18.79 |
|  | A06014000AP (NN-S657)       | \$24.31 |
| Roller Ring (see diagram on page 7)      | B290D5950AP (NN-S557, S547) | \$ 8.40 |
|  | B290D5500AP (NN-S647)       | \$13.16 |

① For pricing quotes, call or write the Parts & Literature Department at the phone or address listed below. Please have your credit card information readily available.  
Shipping & handling are not included. Price & availability subject to change. Sorry, no COD's.

PANASONIC SERVICES COMPANY  
20421 84th Avenue South  
Kent, WA 98032

(800) 833-9626 - Phone  
(800) 237-9080 - FAX

# Microwave Shortcuts

| FOOD  | POWER  | TIME<br>(in minutes)<br>(800-1000w oven) | DIRECTIONS  |
|---|--|--|---|
| <b>Butter, Melted</b> , ¼ pound<br><b>Butter, Softened</b> , ¼ pound  | <b>MEDIUM-LOW</b><br><b>LOW</b>                              | 3 - 4<br>1 - 2                           | Remove wrapper and place butter in a microwave-safe dish.   |
| <b>Chocolate, Melted</b> ,<br>1 square (1 oz.)<br><b>Chocolate, Melted</b> ,<br>½ cup chips   | <b>MEDIUM-LOW</b><br><b>MEDIUM-LOW</b>                       | 3 - 4<br>2 - 3                           | Remove wrapper and place chocolate in dish. Stir before adding more time. Chocolate holds its shape even when softened.                   |
| <b>Bacon, Separated</b> ,<br>1 lb.  | <b>MED-HIGH</b>  | ½ - 1                                    | Remove wrapper. After heating, use a plastic spatula to separate slices.  |
| <b>Cream Cheese, Softened</b> , 3 oz.   | <b>LOW</b>   | 1 - 2                                    | Remove wrapper and place in a bowl.   |
| <b>Cup of Water</b> (boiling)<br>1 cup (8 oz.)<br>2 cups (16 oz.)<br><b>Cup of Milk</b> (scalded)<br>1 cup (8 oz.)<br>2 cups (16 oz.) | <b>HIGH</b><br><b>HIGH</b><br><b>MEDIUM</b><br><b>MEDIUM</b> | 2 - 3<br>6½<br>3 - 4½<br>5 - 7           | Heated liquids can erupt if not mixed with air. Do not heat liquids in your microwave oven without stirring first.                        |
| <b>Coconut, Toasted</b> ,<br>½ cup  | <b>MED-HIGH</b>  | 2 - 4                                    | Place in a pie plate or bowl. Stir every 30 seconds.  |
| <b>Ground Beef, Browned</b> ,<br>1 lb.  | <b>HIGH</b>  | 3 - 5                                    | Crumble in microwave-safe colander set in another dish. Stir twice.   |
| <b>Ice Cream, Softened</b> ,<br>½ gallon  | <b>LOW</b>   | 2 - 3                                    | —————   |
| <b>Nuts, Roasted</b> ,<br>½ cup   | <b>MED-HIGH</b>  | 4 - 6                                    | Spread nuts in 9-inch pie plate. Stir twice.  |
| <b>Sesame Seeds, Toasted</b> ,<br>½ cup   | <b>HIGH</b>  | 4  | Place in a small bowl. Stir twice.  |
| <b>Brown sugar, Softened</b>  | <b>HIGH</b>  | ¾  | Place 1 cup hard brown sugar in dish with a slice of bread or a wedge of apple. Cover with plastic wrap.                                  |
| <b>To Remove Oven Odors</b>   | <b>HIGH</b>  | 5  | Combine 1 to 1½ cups of water with the juice and peel of one lemon in a small bowl. After heating, wipe interior of oven with damp cloth. |

# Care of Your Microwave Oven

**BEFORE CLEANING:** Unplug at socket of the oven. If impossible, leave oven door open to prevent oven from accidentally turning on.

**Inside of the oven:** Wipe with a damp cloth. Mild detergent may be used if the oven gets very dirty. **DO NOT** use harsh detergent or abrasives.

**Outside oven surfaces:** Clean with a damp cloth. To prevent damage to the operating parts inside the oven, water should not be allowed to seep into ventilation openings.

**Control Panel:** If it becomes wet, clean with a soft, dry cloth. **DO NOT** use harsh detergents or abrasives on the Control Panel.

**Glass Tray:** Remove and wash in warm sudsy water or in a dishwasher.

**Oven Door:** Wipe with a soft cloth or paper towel when steam accumulates inside or around the outside. During cooking, especially under high humidity conditions, steam is given off from the food. (Some steam will condense on cooler surfaces, such as the oven door.) This is normal.

**The roller ring and oven cavity floor:** Wipe the bottom surface of the oven with mild detergent water or window cleaner and dry. The roller ring may be washed in mild sudsy water or dishwasher. These areas should be kept clean to avoid excessive noise.

**AFTER CLEANING:** Be sure to replace the Roller Ring and Glass Tray in the proper position and press **Stop/Reset** Pad to clear the screen.

## Before Requesting Service

### All these are normal:

The oven causes interference with my TV.

Some radio and TV interference might occur when you cook with the microwave oven. This interference is similar to the interference caused by small appliances such as mixers, vacuums, blow dryers, etc. It does not indicate a problem with your oven.

The oven lights dim.

When cooking with a power other than HIGH, the oven must cycle to obtain the lower power levels. The oven light will dim and clicking noises can be heard when the oven cycles. This is normal operation.

Steam accumulates on the oven door and warm air comes from the oven vents.

During cooking, steam and warm air are given off from the food. Most of the steam and warm air are removed from the oven by the air which circulates in the oven cavity. However, some steam will condense on cooler surfaces such as the oven door. This is normal.

I accidentally ran my microwave oven without any food in it.

Running the oven empty for a short time will not damage the oven. However, we do not recommend operating the oven in this manner.

### PROBLEM

### POSSIBLE CAUSE

### REMEDY

Oven will not turn on.



The oven is not plugged in securely.

Remove plug from outlet, wait 10 seconds and reinsert.

Circuit breaker or fuse is tripped or blown.

Reset circuit breaker or replace fuse.

There is a problem with the outlet.

Plug another appliance into the outlet to check if it is working.

Oven will not start cooking.



The door is not closed completely.

Close the oven door securely.

Another program entered already in the oven.

Press **Stop/Reset** Pad to cancel the previous program and program again.

When the oven is turned on, there is a noise coming from the glass tray









The roller ring and oven bottom are dirty.

Clean these parts according to "Care of Your Microwave Oven" above.

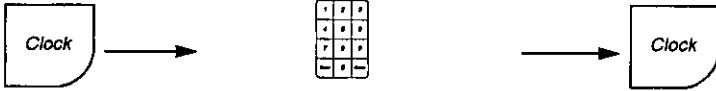
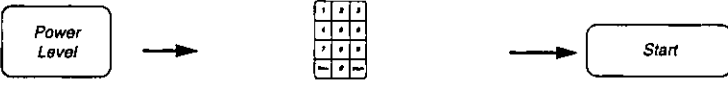
If it seems there is a problem with the oven, contact an authorized Servicer.

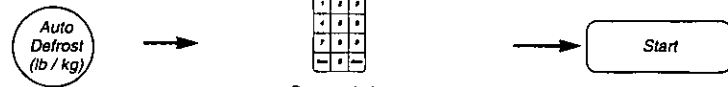

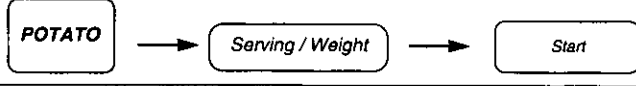
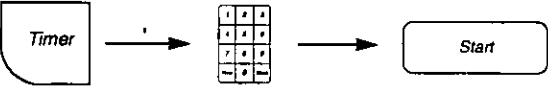
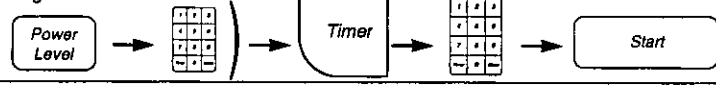
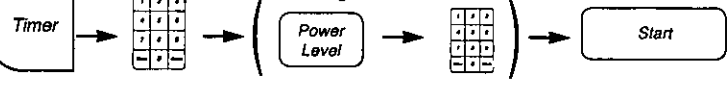
# Quick Guide to Operation

| Feature   | How to Operate  |
|---|---|
| To Set Clock<br>(☛page 8)                                     |  <p>Enter time of day.</p>                      |
| To Reheat/Defrost/Cook by setting power and time<br>(☛page 9) |  <p>Select power.      Set cooking time.</p>    |
| To Reheat using "Auto Reheat" Pad<br>(☛page 10)               |  <p>Select serving. (1-4)</p>                    |
| To Defrost using "Auto Defrost" Pad<br>(☛page 10)             |  <p>Set weight.</p>                             |
| To Cook using "Popcorn" Pad<br>(☛page 8)                      |  <p>Set weight.</p>                              |
| To Cook using "Recipe" Pads<br>(NN-S657/S557) (☛page 11)      | <p>Select desired category.<br/>e.g.</p>        |
| To Use as a Kitchen Timer<br>(☛page 9)                        |   |
| To Set Standing Time<br>(☛page 9)                             | <p>Set desired cooking program.<br/>e.g.</p>  |
| To Set Delay Start<br>(☛page 9)                               | <p>Set desired cooking program.<br/>e.g.</p>  |
| To Cook using Convenience Pads<br>(NN-S647/S547) (☛page 11)   |  <p>Press for Desired Category</p>            |

Panasonic Consumer Electronics  
Company, Division of Matsushita  
Electric Corporation of America  
One Panasonic Way  
Secaucus, New Jersey 07094

Panasonic Sales Company, Division  
of Matsushita Electric of Puerto Rico,  
Inc. ("PSC")  
Ave. 65 de Infanteria, Km. 9.5  
San Gabriel Industrial Park,  
Carolina, Puerto Rico 00985

B00039500AP  
S0197-0  
Printed in U.S.A.