

This Owner's Manual is provided and hosted by [Appliance Factory Parts](#).

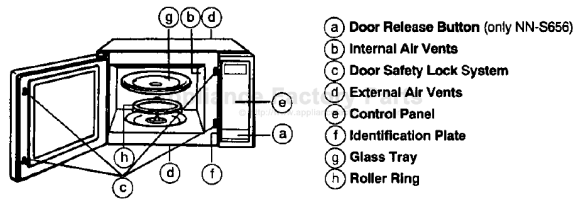

PANASONIC NN-S656 Owner's Manual

**Shop genuine replacement parts for PANASONIC
NN-S656**



Find Your PANASONIC Microwave Parts - Select From 742 Models

----- Manual continues below -----

Panasonic®

Operating Instructions

Microwave Oven

Model NN-S766 / NN-E766

NN-S666 / NN-E666

NN-S656 / NN-S566 / NN-E566

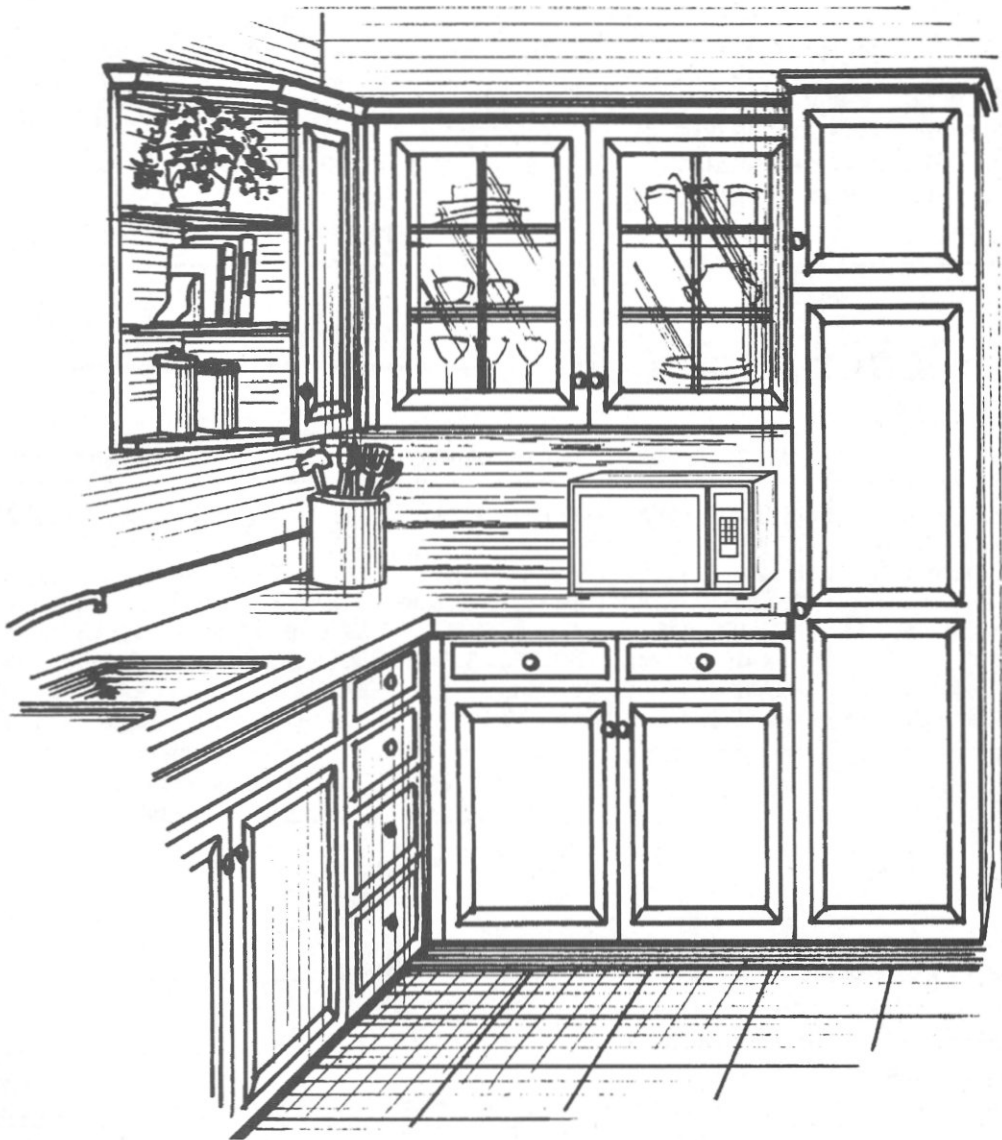

Before operating this oven, please read these instructions completely.
Antes de operar este producto, lea este instructivo en su totalidad.
El manual de instrucciones en español puede ser encontrada en la páginas 15-25.
(Spanish Operating Instructions can be found on pages 15-25.)

Thank you for purchasing the Panasonic Microwave Oven.

PRECAUTIONS TO AVOID POSSIBLE EXPOSURE TO EXCESSIVE MICROWAVE ENERGY

- | | |
|--|--|
| <p>(a) Do not attempt to operate this oven with the door open since open-door operation can result in harmful exposure to microwave energy. It is important not to defeat or tamper with the safety interlocks.</p> <p>(b) Do not place any object between the oven front face and the door, or allow soil or cleaner residue to accumulate on sealing surfaces.</p> | <p>(c) Do not operate the oven if it is damaged. It is particularly important that the oven door close properly and that there is no damage to the:</p> <ol style="list-style-type: none"> (1) door (bent) (2) hinges and latches (broken or loosened) (3) door seals and sealing surfaces. <p>(d) The oven should not be adjusted or repaired by anyone except properly qualified service personnel.</p> |
|--|--|

Technical Specifications

	NN-S766/NN-E766	NN-S666/NN-E666	NN-S656	NN-S566/NN-E566
Power Consumption:	14.5 Amps, 1,660 W	14.5 Amps, 1,660 W	13.5 Amps, 1,550 W	13.5 A, 1,550 W
Output:*	1000 W	1000 W	950 W	1000 W
Outside Dimensions (H x W x D):	14" x 23 $\frac{1}{8}$ " x 16 $\frac{1}{8}$ " (356 x 595 x 415mm)	12" x 21 $\frac{1}{8}$ " x 16 $\frac{1}{4}$ " (306 x 555 x 425mm)	12" x 21 $\frac{1}{8}$ " x 16 $\frac{1}{8}$ " (306 x 555 x 425mm)	12" x 20" x 14 $\frac{1}{8}$ " (306 x 510 x 360mm)
Oven Cavity Dimensions (H x W x D):	10 $\frac{1}{8}$ " x 16 $\frac{1}{8}$ " x 15 $\frac{1}{8}$ " (259 x 415 x 385mm)	8 $\frac{1}{8}$ " x 14 $\frac{1}{8}$ " x 15 $\frac{1}{8}$ " (220 x 375 x 395mm)	8 $\frac{1}{8}$ " x 14 $\frac{1}{8}$ " x 15 $\frac{1}{8}$ " (220 x 375 x 395mm)	9" x 13 $\frac{1}{8}$ " x 13 $\frac{1}{8}$ " (229 x 353 x 338mm)
Operating Frequency:	2,450MHz	2,450MHz	2,450MHz	2,450MHz
Uncrated Weight (Approx.):	40 lbs. (18.0 kg)	38 lbs. (17 kg)	38 lbs. (17 kg)	34 lbs. (15.3 kg)

*IEC 705-88 Test procedure
Specifications subject to change without notice.

The serial number of this product may be found on the right side of the oven door opening. You should note the model number and the serial number of this oven in the space provided and retain this book as a permanent record of your purchase for future reference.

Model No. _____

Serial No. _____

Date of Purchase _____

CONTENTS

Before Operating

Precautions	Inside Front Cover
Safety Instructions	2
Installation Instructions	3
Grounding Instructions	3
Practical Hints	4
Cookware and Utensil Guide	5
Feature Diagram	6
Control Panel	6

Operation & Hints

Function Pad	7
To Set Clock	8
To Use Popcorn Pad	8
To Reheat using Power and Time Setting	8
Auto Reheat Pad	9
To Defrost using Power and Time Setting	8
Auto Defrost Pad	9
To Cook using Power and Time Setting	8
Auto Cook	10
To Set Timer (Stand Time/Delay Start)	11
Quick Guide to Operation	Back Cover

Maintenance

Before Requesting Service	12
Care of Your Microwave Oven	12
Technical Specifications	Inside Front Cover

Manual de instrucciones (Spanish Operating Instructions)

Precauciones	15
Instrucciones de Seguridad	15
Instrucciones para Conexión a Tierra	16
Instrucción de Instalación	17
Sugerencias Útiles	18
Panel de Controles	19
Diagrama de Características	19
Procedimientos de Operación	20-24
Cuidados de Su Horno de Microondas	25
Antes de Acudir a Servicio	25

IMPORTANT SAFETY INSTRUCTIONS

Your microwave oven is a cooking device and you should use as much care as you use with a stove or any other cooking device.

When using this electric appliance, basic safety precautions should be followed, including the following:

WARNING—To reduce the risk of burns, electric shock, fire, injury to persons or exposure to excessive microwave energy:

1. Read all instructions before using the appliance.
2. Read and follow the specific "**PRECAUTIONS TO AVOID POSSIBLE EXPOSURE TO EXCESSIVE MICROWAVE ENERGY**," found on back of the front cover.
3. This appliance must be grounded. Connect only to properly grounded outlet. See "**GROUNDING INSTRUCTIONS**" found on page 3.
4. Install or locate this appliance only in accordance with the installation instructions found on page 3.
5. Do not cover or block any openings on this appliance.
6. Do not store or use this appliance outdoors. Do not use this product near water—for example, near a kitchen sink, in a wet basement, or near a swimming pool, and the like.
7. Use this appliance only for its intended use as described in this manual. Do not use corrosive chemicals or vapors in this appliance. This type of oven is specifically designed to heat, cook or dry food. It is not designed for industrial or laboratory use.
8. When cleaning surfaces of door and oven that come together on closing the door, use only mild, non-abrasive soaps or detergents applied with a sponge or soft cloth.
9. Do not allow children to use this appliance, unless closely supervised by an adult.
10. Do not operate this appliance if it has a damaged cord or plug, if it is not working properly, or if it has been damaged or dropped.
11. Do not immerse cord or plug in water.
12. Keep cord away from heated surfaces.
13. Do not let cord hang over edge of table or counter.
14. This appliance should be serviced only by qualified service personnel. Contact the nearest authorized service facility for examination, repair or adjustment.
15. Some products such as whole eggs and sealed containers—for example, closed glass jars—may explode and should not be heated in this oven.
16. To reduce the risk of fire in the oven cavity:
 - (a) Do not overcook food. Carefully attend appliance if paper, plastic, or other combustible materials are placed inside the oven to facilitate cooking.
 - (b) Remove wire twist-ties from paper or plastic bags before placing bag in oven.
 - (c) If materials inside the oven should ignite, keep oven door closed, turn oven off, and disconnect the power cord, or shut off power at the fuse or circuit breaker panel.

- (d) Do not use the cavity for storage purposes. Do not leave paper products, cooking utensils, or food in the cavity when not in use.

General Use

1. **DO NOT** tamper with or make any adjustments or repairs to door, control panel housing, safety interlock switches or any other part of the oven. **DO NOT** remove outer panel from oven. Repairs should only be done by a qualified service person.

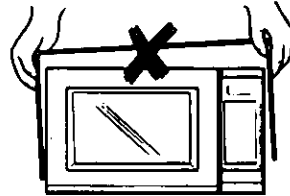

2. **DO NOT** operate the oven empty. The microwave energy will reflect continuously throughout the oven if food or water is not present to absorb energy. This could damage the oven and result in the danger of a fire.

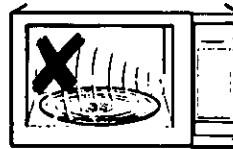

3. **DO NOT** use this oven to heat chemicals or any other non-food products. **DO NOT** clean this oven with any product that is labeled as containing corrosive chemicals. **The heating of corrosive chemicals in this oven can cause radiation leaks.**
4. **DO NOT** dry clothes, newspapers or other materials in oven. They may catch fire.
5. **DO NOT** use recycled paper products unless the paper product is labeled as safe for microwave oven use. Recycled paper products may contain impurities which may cause sparks and/or fires when used.
6. **DO NOT** use newspapers or paper bags for cooking. Fire can result.
7. **DO NOT** hit or strike control panel. Damage to controls may occur. Fire can result.
8. **POT HOLDERS** should always be used when removing items from the oven. Heat is transferred from the **HOT** food to the cooking container and from the cooking container to the Glass Tray. Glass Tray can be very **HOT** after removing cooking container from oven.
9. **DO NOT** store flammable materials next to, on top of, or in the oven. These could be fire hazards.

SAVE THESE INSTRUCTIONS

For proper use of your oven read remaining safety cautions and operating instructions.

INSTALLATION & GROUNDING INSTRUCTIONS

Examine Your Oven

Unpack oven, remove all packing material, and examine the oven for any damage such as dents, broken door latches or cracks in the door. Notify dealer immediately if oven is damaged. **DO NOT** install if oven is damaged.

Placement of Oven

1. Oven must be placed on a flat, stable surface. For proper operation, the oven must have sufficient air flow. Allow 3 inches (8 cm) of space on both sides of the oven and 1 inch (2.5 cm) of space on top of oven.
 - a. **DO NOT** block air vents.
If they are blocked during operation, the oven may overheat. If the oven overheats, a thermal safety device will turn the oven off. The oven will remain inoperable until it has cooled.
 - b. **DO NOT** place oven near a hot damp surface such as a gas or electric range.
 - c. **DO NOT** operate oven when room humidity is too high.
2. This oven was manufactured for household use only.

Grounding Instructions

This appliance must be grounded. In the event of an electrical short circuit, grounding reduces the risk of electric shock by providing an escape wire for the electric current. This appliance is equipped with a cord having a grounding wire with a grounding plug. The plug must be plugged into an outlet that is properly installed and grounded.

WARNING—Improper use of the grounding plug can result in a risk of electric shock.

Consult a qualified electrician or service person if the grounding instructions are not completely understood, or if doubt exists as to whether the appliance is properly grounded.

If it is necessary to use an extension cord, use only a three wire extension cord that has a three blade grounding plug, and a three slot receptacle that will accept the plug on the appliance. The marked rating of the extension cord should be equal to or greater than the electrical rating of the appliance.

Power Supply

1. A short power-supply cord is provided to reduce the risks resulting from becoming entangled in or tripping over a longer cord.
2. Longer cord sets or extension cords are available and may be used if care is exercised in their use.
3. If a long cord or extension cord is used, (1) the marked electrical rating of the cord set or extension cord should be at least as great as the electrical rating of the appliance, (2) the extension cord must be a grounding-type 3-wire cord, and (3) the longer cord should be arranged so that it will not drape over the countertop or tabletop where it can be pulled on by children or tripped over accidentally.

Wiring Requirements

1. The oven must be on a **SEPARATE CIRCUIT**. No other appliance should share the circuit with the microwave oven. If it does, the branch circuit fuse may blow, or the circuit breaker may trip or the food may cook slower than the times recommended in this manual.
2. The **VOLTAGE** used must be the same as specified on this microwave oven (120V). Using a higher voltage is dangerous and may result in a fire or other accident causing oven damage. Using a lower voltage will cause slow cooking. Panasonic is **NOT** responsible for damage resulting from the use of the oven with other than specified voltage.
3. The oven must be plugged into at least a **20 AMP 120 VOLT, 60 Hz GROUNDED OUTLET**. Where a standard two-prong outlet is encountered, it is the personal responsibility and obligation of the consumer to have it replaced with a properly grounded three-prong outlet.



4. A **TEMPORARY CONNECTION** with a two-prong adapter may be made where **LOCAL CODES PERMIT** it. Unless the cover screw is grounded through the house wiring, attaching the adapter grounding plate to the cover screw will not ground the oven. If there is any doubt that the cover screw is grounded, have it checked by an electrician.



Radio Interference

1. Operation of the microwave oven may cause interference to your radio, TV or similar equipment.
2. When there is interference, it may be reduced or eliminated by taking the following measures:
 - a. Clean door and sealing surfaces of the oven. (See Care of Your Microwave Oven found on page 12.)
 - b. Place the radio, TV, etc. away from the microwave oven as far as possible.
 - c. Use a properly installed antenna to obtain stronger signal reception.

Follow These Safety Precautions When Cooking in Your Oven

1) HOME CANNING / DRYING FOODS / SMALL QUANTITIES OF FOODS

- Do not use your oven for home canning or the heating of any closed jar. Pressure will build up and the jar may explode. Your oven cannot maintain the food at the proper canning temperature. Improperly canned food may spoil and be dangerous to consume.
- Small quantities of food or foods with low moisture content can dry out, burn or catch on fire.
- Do not dry meats, herbs, fruits or vegetables in your oven.

IMPORTANT

Proper cooking depends on time set and weight of food. If you use a smaller portion than recommended and cook at the time for the recommended portion, fire can result.

If a fire occurs, turn oven off and leave oven door closed. Disconnect the power cord or shut off power at the fuse or circuit breaker panel.

2) POPCORN

Popcorn must be popped in a microwave oven corn popper. Microwave popcorn which pops in its own package is also available. Follow popcorn manufacturers' directions and use a brand suitable for the wattage of your microwave oven. Never leave oven unattended when popping popcorn.

CAUTION:

When using pre-packaged microwave popcorn, follow recommended package instructions.

Check package weight before using the popcorn pad. Set the oven for the weight of the popcorn package. (see page 8)

If these instructions are not followed, the popcorn may not pop adequately or may ignite and cause a fire.

3) DEEP FAT FRYING

- Do not attempt to deep fat fry in your microwave oven. Cooking oils may burst into flames and may cause damage to the oven and perhaps result in burns. Microwave utensils may not be able to withstand the temperature of the hot oil, and could shatter.

4) EGGS

- Do not heat eggs in their shell in a microwave oven. Pressure will build up and the eggs will explode.

5) FOODS WITH NONPOROUS SKINS

- Potatoes, apples, egg yolks, whole squash and sausages are examples of foods with nonporous skins. These types of foods must be pierced before Microwave cooking to prevent their bursting.
- Use fresh potatoes for baking and cook until just done. Overcooking causes dehydration and may cause a fire. Use recommended weights or fire may occur.

6) LIQUIDS

- Heated liquids can erupt if not mixed with air. Do not heat liquids in your microwave oven without first stirring.

7) GLASS TRAY / COOKING UTENSILS / FOIL

- Cooking utensils get hot during Microwaving. Use potholders when removing utensils from the oven or when removing lids or plastic wrap covers from cooking utensils to avoid burns.
- The glass tray will get hot during cooking. It should be allowed to cool before handling or before paper products, such as paper plates or microwave popcorn bags, are placed in the oven for microwave cooking.
- When using foil, skewers, warming rack or utensils made of metal in the oven, allow at least 1-inch (2.5 cm) of space between metal material and interior oven walls. If arcing occurs (sparking) remove metal material (skewers etc.) and/or transfer to a non-metallic container.
- Dishes with metallic trim should not be used, as arcing may occur.

8) PAPER TOWELS / CLOTHS

- Do not use paper towels or cloths which contain a synthetic fiber woven into them. The synthetic fiber may cause the towel to ignite.
- Do not use paper bags or recycled paper products in the microwave oven.

9) BROWNING DISHES / OVEN COOKING BAGS

- Browning dishes or grills are designed for microwave cooking only. Always follow instructions provided by the manufacturer. Do not preheat browning dish more than 8 minutes.
- If an oven cooking bag is used for Microwave cooking, prepare according to package directions. Do not use a wire twist-tie to close bag.

10) THERMOMETERS

- Do not use a conventional meat thermometer in your oven. Arcing may occur.

11) BABY FORMULA/FOOD

- Do not heat baby formula or food in the microwave oven. The glass jar or surface of the food may appear warm while the interior can burn the infant's mouth and esophagus.

12) REHEATING PASTRY PRODUCTS

- When reheating pastry products, check temperatures of any fillings before eating. Some foods have fillings which heat faster and can be extremely hot while the surface remains warm to the touch (ex. Jelly Donuts).

13) GENERAL OVEN USAGE GUIDELINES / OVEN DOOR

- Do not use the oven for any reason other than the preparation of food.
- Do not leave oven unattended while in use.

Cookware and Utensil Guide

ITEM	MICROWAVE	COMMENTS
Aluminum Foil	Yes for Shielding	Small strips of foil can be molded around thin parts of meat or poultry to prevent overcooking. Arcing can occur if foil is too close to oven wall or if too much foil is used.
Browning Dish	Yes	Browning dishes are designed for microwave cooking only. Check browning dish information for instructions and heating chart. Do not preheat for more than 8 minutes.
Brown paper bags	No	May cause a fire in the oven.
Dinnerware Microwave-Safe, only	Yes	Check manufacturers' use and care directions for suitability for microwave heating. Some dinnerware may state on the back of the dish, "Oven-Microwave Proof."
Disposable polyester Paperboard Dishes	Yes	Some frozen foods are packaged in these dishes. Can be purchased in grocery stores.
Fast Food Carton with Metal Handle	No	May cause arcing.
Frozen Dinner Tray Metal	Yes	Frozen dinners may be heated in foil tray, if tray is less than ¾-inch (2 cm) high. Place foil tray in center of oven. Leave at least 1-inch (2.5 cm) space between foil tray and oven walls. Heat only 1 foil tray in the oven at a time. For containers more than ¾-inch deep, remove food and place in a similar size microwave-safe container.
Microwave-safe	Yes	
Glass Jars	Yes	Remove lid. Heat food until just warm. Most glass jars are not heat resistant.
Glassware Heat Resistant Oven Glassware and Ceramic, only	Yes	Ideal for microwave cooking and browning.
Metal Twist Ties	No	They may cause arcing when could cause a fire in the oven.
Oven Cooking Bag	Yes	Follow manufacturers' directions. Close bag with the nylon tie provided, a strip cut from the end of the bag, or a piece of cotton string. Do not close with metal twist tie. Make six ½-inch slits by closure.
Paper Plates & Cups	Yes	Use to warm cooked foods, and to cook foods that require short cooking times such as frankfurters.
Paper Towels & Napkins	Yes	Use to warm rolls and sandwiches by microwave.
Plastic Microwave-Safe, only Cookware and Storage Dishes	Yes	Should be labeled, "Suitable for microwave heating." Check manufacturers' directions for recommended uses. Some microwave-safe plastic dishes are not suitable for cooking foods with high fat content.
Plastic Foam Cups	Yes	Use to bring foods to a low serving temperature. Plastic foam will melt if foods reach a high temperature.
Plastic Wrap	Yes	Use to cover food during cooking to retain moisture.
Straw, Wicker, Wood	Yes	Use only for short term reheating.
Thermometers Microwave-safe, only	Yes	Use only microwave-safe meat and candy thermometers. Not suitable for use in microwave oven.
Conventional	No	
Wax paper	Yes	Use as a cover to prevent spattering and to retain moisture.

TO TEST A CONTAINER FOR SAFE MICROWAVE OVEN USE: Fill a 1 -cup glass measure with water and place it in the microwave oven along with the container to be tested; **heat one minute at HIGH**. If the container is microwave oven-safe, it should remain comfortably cool and the water should be hot. If the container is hot, it has absorbed some microwave energy and should not be used. This test cannot be used for plastic containers.

Features

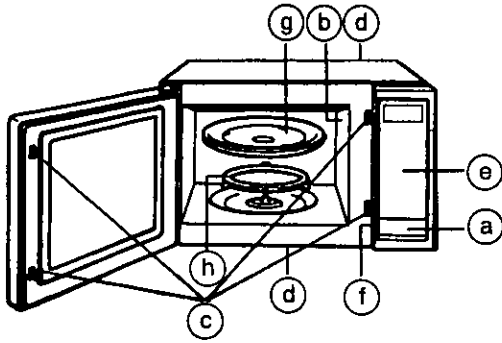

- (a) Door Release Button (only NN-S656)
- (b) Internal Air Vents
- (c) Door Safety Lock System
- (d) External Air Vents
- (e) Control Panel
- (f) Identification Plate
- (g) Glass Tray
- (h) Roller Ring

Control Panels

NN-S656

NN-S766,S666,S566

NN-E766,E666,E566

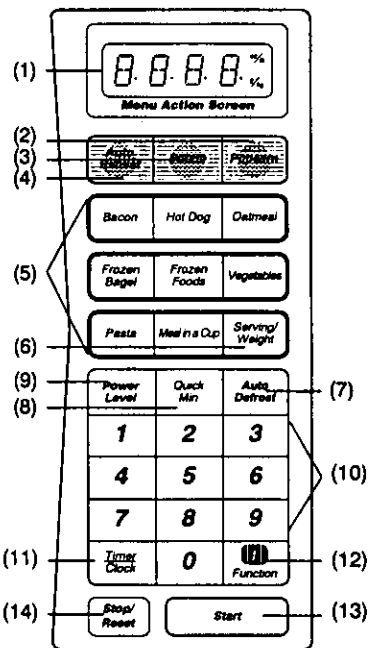
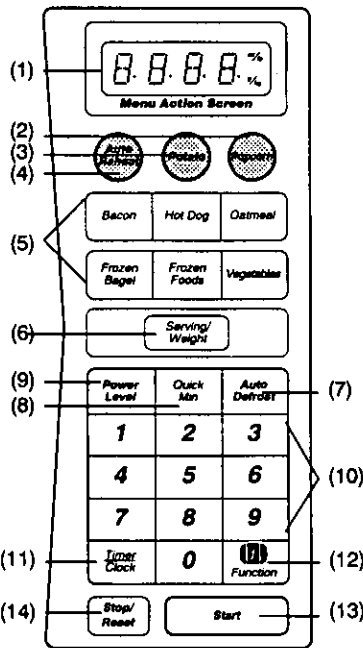
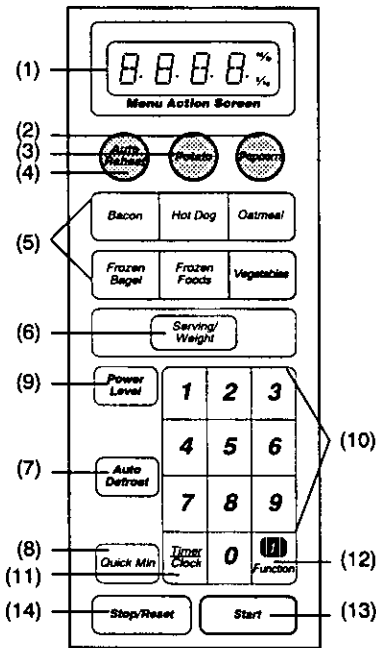

- (1) Menu Action Screen-Display
- (2) Popcorn Pad
- (3) Potato Pad
- (4) Auto Reheat Pad
- (5) Auto Cook Pads
- (6) Serving/Weight Pad

- (7) Auto Defrost Pad
- (8) Quick Min Pad
- (9) Power Level Pad
- (10) Number Pads
- (11) Timer Clock Pad
- (12) Function Pad

(13) Start Pad:

One taps allows oven to begin functioning. If door is opened or Stop/Reset Pad is pressed once during oven operation, Start Pad must be pressed again to restart oven.

(14) Stop/Reset Pad:

Before cooking: One tap clears your instruction.
During cooking: One tap temporarily stops the cooking process. Another tap cancels all your instructions and time of day appears on the display screen.

Functions

This unique feature of your PANASONIC microwave oven allows you to establish the initial non-cooking features of your oven such as CHILD LOCK, WORD SPEED, LANGUAGE CHOICE (ENGLISH, SPANISH OR FRENCH), plus many more. See below.









1	<p>LANGUAGE CHOICE The oven has English, French and Spanish display. The display appears in English when you plug-in.</p> <ul style="list-style-type: none"> 1 ENGLISH → Display appears in English. 2 FRANCAIS → Display appears in French. 3 ESPANOL → Display appears in Spanish.
2	<p>Lb/KG CHOICE The oven has both imperial and metric weight measurements. The oven displays the weight in imperial when you plug it in.</p> <ul style="list-style-type: none"> 1 Lb → Weight can be set in lb/oz. 2 KG → Weight can be set in g/kg.
3	<p>WORD SPEED The speed of word scrolling in the display window can be quickened or slowed down.</p> <ul style="list-style-type: none"> 1 QUICK → Words scroll quickly. 2 MEDIUM → Scrolling speed reverts to initial setting. 3 SLOW → Words scroll slowly.
4	<p>MENU ACTION ON/OFF MENU ACTION SCREEN helps you to program your oven by prompting the next step to be taken. When you become familiar with your oven, the prompting can be turned off.</p> <ul style="list-style-type: none"> 1 ON → Prompting Guide will reappear. 2 OFF → Prompting Guide will not appear.
5	<p>CHILD LOCK ON/OFF The oven has Child Safety Lock feature which prevents use by children.</p> <ul style="list-style-type: none"> 1 ON → Child Lock has been set and operation will not be accepted. 2 OFF → Child Lock has been cancelled.
6	<p>BEEP ON/OFF If you wish to have the oven operate with no beep, it can be eliminated.</p> <ul style="list-style-type: none"> 1 ON → Beep sound will reactivate. 2 OFF → Beep sound will not be heard.
7	<p>REMINDER BEEP ON/OFF A reminder beep works to remind you to remove the food from the oven after the completion of cooking. It will occur every few seconds.</p> <ul style="list-style-type: none"> 1 ON → Reminder beep will work. 2 OFF → Reminder beep will not work.
8	<p>DAYLIGHT SAVING ON/OFF</p> <ul style="list-style-type: none"> 1 ON → Time of day will advance one hour. 2 OFF → Time of day revert to original setting.
9	<p>CLOCK ON/OFF Clock display can be turned off.</p> <ul style="list-style-type: none"> 1 ON → Clock display will appear in the display window. 2 OFF → Clock display will not appear in the display window. <p>Time of day will not be lost while the display is off.</p>
0	<p>DEMO MODE ON/OFF Demo mode is designed for retail store display. In this mode, the oven can be demonstrated with no power in the oven.</p> <ul style="list-style-type: none"> 1 ON → The oven will be in demo mode. 2 OFF → The oven will be out of demo mode.

Clock Setting

You can use the oven without setting the clock.

Example: To set 11:25

1.		<ul style="list-style-type: none"> Press. <ul style="list-style-type: none"> ➤Colon will blink.
2.	   	<ul style="list-style-type: none"> Enter time of day. <ul style="list-style-type: none"> ➤Time appears on the screen; colon is blinking.
3.		<ul style="list-style-type: none"> Press. <ul style="list-style-type: none"> ➤Colon stops blinking; time of day is entered and locked onto the screen.





NOTES:

- To reset time of day, repeat step 1 through step 3.
- The clock will keep the time of day as long as oven is plugged in and electricity is supplied.
- If the area you live in adjusts their clock either forward or backward during the year, see the feature on FUNCTION PAD #8 for easy adjustment.

Power & Time Setting

How do I program Power and Time?

Example: To cook at MEDIUM Power for 1 minute 30 seconds

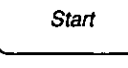
1.	 4 times	<ul style="list-style-type: none"> Select Power Level (according to the chart below).
2.	  	<ul style="list-style-type: none"> Set Cooking Time (up to 99 minutes and 99 seconds for a single stage).
3.		<ul style="list-style-type: none"> Press. <ul style="list-style-type: none"> ➤Cooking will start. The time on the screen will begin to count down.



Press	Power Level	% Power
once	HIGH	100%
twice	DEFROST	30%
3 times	MEDIUM-HIGH	70%
4 times	MEDIUM	55%
5 times	MEDIUM-LOW	30%
6 times	LOW	10%

NOTES:

- For 2 or 3 stage cooking, repeat steps 1 and 2 above before pressing Start Pad.
- When selecting HIGH Power on the first stage, you can start from step 2.

Popcorn Function

Example: To heat 3.5 oz. of Popcorn

1.	 Press once	<ul style="list-style-type: none"> Set the desired weight of prepackaged microwave popcorn. <table border="1"> <thead> <tr> <th>Press</th> <th>Weight</th> </tr> </thead> <tbody> <tr> <td>once</td> <td>3.5 oz. (100 g)</td> </tr> <tr> <td>twice</td> <td>3.0 oz. (90 g)</td> </tr> <tr> <td>3 times</td> <td>1.75 oz. (50 g)</td> </tr> </tbody> </table>	Press	Weight	once	3.5 oz. (100 g)	twice	3.0 oz. (90 g)	3 times	1.75 oz. (50 g)
Press	Weight									
once	3.5 oz. (100 g)									
twice	3.0 oz. (90 g)									
3 times	1.75 oz. (50 g)									
2.		<ul style="list-style-type: none"> Press. <ul style="list-style-type: none"> ➤Cooking time appears and begins to count down. 								



NOTES ON POPCORN PAD:

- Use prepackaged **room temperature** microwave popcorn. Read manufacturers' instructions.
- Place bag in oven according to manufacturers' directions.
- Pop only one bag at a time.
- After popping, allow the contents of the bag to cool for a few minutes before opening. Open bag carefully away from face and body because popcorn and steam are extremely hot.
- Do not reheat unpopped kernels or reuse bag.
- NEVER** leave oven unattended when popping popcorn.

CAUTION: If prepackaged popcorn is of a different weight than the recommended weight, do not use the popcorn setting, or inadequate popping or a fire may occur. Follow the manufacturers' instructions.

Auto Defrost

This feature allows you to defrost meat, poultry and seafood by weight without setting time.

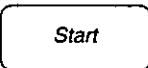
Example: To defrost 1.5 lb. of meat		
1.		• Press.
2.	 	• Set the weight of the food. Weight must be programmed in pounds and tenths of a pound (not ounces). See conversion chart below.
3.		• Press. ➤ Defrosting time appears on the screen and begins to count down.

NOTE:

- For best results, the minimum recommended weight is 0.5 lb. (220 g).
- The shape and size of the food will determine the maximum weight the oven can accommodate. The recommended **maximum weight of meat is 4 lb. (1.8 kg); poultry, 6 lb. (2.7 kg) and seafood, 3 lb. (1.4 kg).**
- Stand time or power level may be programmed after Auto Defrost.
- The oven beeps during the defrosting cycle to signal that the food needs to be turned or rearranged. To prevent overdefrosting, thin areas or edges can be shielded with strips of aluminum foil.



Conversion Chart:

Follow this chart to convert ounces or hundredths of a pound into tenths of a pound. If a piece of meat weighs 1.95 pounds or 1 pound 14 ounces, program 1.9 pounds.

Ounces	Hundredths of a Pound	Tenths of a Pound
0	.96 - .05	0.0
1 - 2	.06 - .15	0.1
3 - 4	.16 - .25	0.2
5	.26 - .35	0.3
6 - 7	.36 - .45	0.4
8	.46 - .55	0.5
9 - 10	.56 - .65	0.6
11 - 12	.66 - .75	0.7
13	.76 - .85	0.8
14 - 15	.86 - .95	0.9

Auto Reheat

This feature allows you to reheat 1 to 4 servings of precooked room temperature and refrigerator temperature foods without setting power and time.

Example: To reheat 2 cups of soup		
1.	 twice	• Press until the desired number of servings appears on the screen.
2.		• Press. ➤ Cooking time appears on the screen and begins to count down.

NOTES:

- Auto Reheat can be programmed for 1 to 4 servings.
- The following are the recommended food items and approximate weights.

Foods	Number of Servings	Serving Size	Starting Temp.
Plate of Food	1	12 to 16 oz.	Refrig.
Meat, Poultry	1 - 4	4 to 6 oz.	Refrig.
Casseroles	1 - 2	8 oz.	Refrig. or Room
Side Dishes	1 - 4	4 to 6 oz.	Refrig. or Room
Soups, Sauces Gravy	1 - 2	4 to 6 oz.	Refrig. or Room

For best results follow these recommendations:

- All foods must be previously cooked.
- Foods should always be covered loosely with plastic wrap, wax paper or casserole lid.
- All foods should have a covered stand time of 3 to 5 minutes.
- DO NOT** reheat bread and pastry products. Use manual power and time.
- DO NOT** reheat beverages.

Auto Cook

Using the Auto-Cook Programs

These are tested and pre-timed (based on the power rating of this oven) for the quantity of food listed in the chart below. Locale, power fluctuations and personal tastes are not taken into account. Should you prefer your food cooked differently, use power and time method shown on page 8.

Example: To cook 1/2 lb. (8 oz.) of fresh vegetables.

1.	VEGETABLES	Press
2.	SERVING/WEIGHT select 8 oz.	Press the SERVING/WEIGHT pad until the desired quantity appears on the screen.
3.	START	Press the START pad. The time for cooking will appear on the screen and count, . . . Simply open the door to stir or to rearrange the food as per the directions.

The following are the recommended servings / weights.



AUTO COOK CODES

PAD	CATEGORY	SERVING/WEIGHT	HINTS
POTATO	1 to 4	6 - 8 oz. each	Pierce skin with a fork, arrange in a circle.
BACON	2,3,4,6		Cover with paper towels.
HOT DOG	1 - 4		Pierce skin.
OATMEAL	1 - 4 serv	As per box	Times based on Quick Cooking oatmeal.
FROZEN FOODS	Dinners	11 oz., 15 oz.	Following the manufacturers' directions for covering or removing covers. For best results, do not use frozen foods packaged in foil trays. Halfway through cooking, rearrange or stir.
	Entrees	8, 10, 20, 32 oz.	
	Vegetables	5, 10, 16 oz.	
FRESH VEGETABLES		8 oz., 16 oz. (For best results, pieces should be the same size).	Cover with a lid or plastic wrap. Add small amount of water. Stir occasionally during cooking. Let stand, covered, 3 -5 minutes before serving.
PASTA	2 oz.	2c water, 1/4t salt, 1/4t oil	Use hot tap water. Be sure to use a large enough dish to prevent spills. After cooking, rinse and drain.
	4 oz.	3c water, 1/2t salt, 1t oil	
	6 oz.	4c water, 1/2t salt, 1/2T oil	
	8 oz.	5c water, 1t salt, 1T oil	
MEAL IN A CUP		7 oz., 10.5 oz.	Follow the manufacturers' directions.





Timer Setting

This feature allows you to program a Standing Time after cooking is completed, to program the oven as a minute timer and/or to program a delay start.





To Use as a Kitchen Timer:

Example: To count 5 minutes	
1. 	• Press.
2. 	• Set desired amount of time (up to 99 minutes and 99 seconds).
3. 	• Press. ▶ Time will count down without oven operating.

To Set Stand Time:

Example: To stand for 5 minutes after cooking (3 mins. at MEDIUM Power)	
1.  4 times ↓ 	• Set the desired cooking program (see page 8 for directions).
2. 	• Press.
3. 	• Set desired amount of Stand Time (up to 99 minutes and 99 seconds).
4. 	• Press. ▶ Cooking will start. After cooking, stand time will count down without oven operating.

To Set Delay Start:

Example: To start cooking 5 minutes later (3 mins. at MEDIUM Power)	
1. 	• Press.
2. 	• Set desired amount of delayed time (up to 99 minutes and 99 seconds).
3.  ↓ 	• Set the desired cooking program (see page 8 for directions).
4. 	• Press. ▶ Delayed time will count down. Then cooking will start.

NOTES:

1. If oven door is opened during Stand Time or Kitchen Timer, the time on the screen will continue to count down.
2. Delay Start cannot be programmed before any Auto Control Function. This is to prevent the starting temperature of the food from rising before defrosting or cooking begins. A change in the starting temperature could cause inaccurate results.

Care of Your Microwave Oven

BEFORE CLEANING: Unplug at socket of the oven. If impossible, leave oven door open to prevent oven from accidentally turning on.

Inside of the oven: Wipe with a damp cloth. Mild detergent may be used if the oven gets very dirty. DO NOT use harsh detergent or abrasives.

Outside oven surfaces: Clean with a damp cloth. To prevent damage to the operating parts inside the oven, water should not be allowed to seep into ventilation openings.

Control Panel: If it becomes wet, clean with a soft, dry cloth. DO NOT use harsh detergents or abrasives on the Control Panel.

Glass Tray: Remove and wash in warm sudsy water or in a dishwasher.

Oven Door: Wipe with a soft cloth when steam accumulates inside or around the outside. During

cooking, especially under high humidity conditions, steam is given off from the food. (Some steam will condense on cooler surfaces, such as the oven door.) This is normal.

The roller ring and oven cavity floor: Wipe the bottom surface of the oven with mild detergent water or window cleaner and dry. The roller ring may be washed in mild sudsy water or dishwasher. These areas should be kept clean to avoid excessive noise.

AFTER CLEANING: Be sure to replace the Roller Ring and Glass Tray in the proper position and press *Stop/Reset* Pad to clear the screen.

STEAM CONDENSATION can cause the inside of the oven and the oven door to rust. To prevent this, wipe these places with a dry cloth to remove any remaining water after you have used the oven.

Before Requesting Service

All these things are normal:

The oven causes interference with my TV.

Some radio and TV interference might occur when you cook with the microwave oven. This interference is similar to the interference caused by small appliances such as mixers, vacuums, blow dryers, etc. It does not indicate a problem with your oven.

The oven lights dim.

When cooking with a power other than HIGH, the oven must cycle to obtain the lower power levels. The oven light will dim and clicking noises can be heard when the oven cycles. This is normal operation.

Steam accumulates on the oven door and warm air comes from the oven vents.

During cooking, steam and warm air are given off from the food. Most of the steam and warm air are removed from the oven by the air which circulates in the oven cavity. However, some steam will condense on cooler surfaces such as the oven door. This is normal.

I accidentally ran my microwave oven without any food in it.

Running the oven empty for a short time will not damage the oven. However, we do not recommend operating the oven in this manner.

PROBLEM

POSSIBLE CAUSE

REMEDY

Oven will not turn on.



The oven is not plugged in securely.

Remove plug from outlet, wait 10 seconds and reinsert.

Circuit breaker or fuse is tripped or blown.

Reset circuit breaker or replace fuse.

There is a problem with the outlet.

Plug another appliance into the outlet to check if it is working.

Oven will not start cooking.



The door is not closed completely.

Close the oven door securely.

Another program entered already in the oven.

Press *Stop/Reset* Pad to cancel the previous program and program again.

When the oven is turning on, there is noise coming from the glass tray.



The roller ring and oven bottom are dirty.

Clean these parts according to "Care of Your Microwave Oven."

If it seems there is a problem with the oven, contact an authorized Servicenter.