

This Owner's Manual is provided and hosted by [Appliance Factory Parts](#).



LG ARNU153BHA2 Owner's Manual

[Shop genuine replacement parts for LG ARNU153BHA2](#)



[Find Your LG Air Conditioner Parts - Select From 2328 Models](#)

----- Manual continues below -----



website <http://www.lgservice.com>

LG

MULTI V[™] System Indoor Unit (2 Series)

INSTALLATION MANUAL

Type: Ceiling Concealed Duct - High Static

ENGLISH

FRANÇAIS

ESPAÑOL

IMPORTANT

- Please read this installation manual completely before installing the product.
- Installation work must be performed in accordance with the national wiring standards by authorized personnel only.
- Please retain this installation manual for future reference after reading it thoroughly.

IMPORTANT!

Please read this instruction sheet completely before installing the product.

This air conditioning system meets strict safety and operating standards. As the installer or service person, it is an important part of your job to install or service the system so it operates safely and efficiently.

WARNING

- Installation or repairs made by unqualified persons can result in hazards to you and others. Installation MUST conform with local building codes or, in the absence of local codes, with the National Electrical Code NFPA 70/ANSI C1-1993 or current edition and Canadian Electrical Code Part1 CSA C.22.1.
- The information contained in the manual is intended for use by a qualified service technician familiar with safety procedures and equipped with the proper tools and test instruments.
- Failure to carefully read and follow all instructions in this manual can result in equipment malfunction, property damage, personal injury and/or death.

CAUTION: Improper installation, adjustment, alteration, service or maintenance can void the warranty. The weight of the condensing unit requires caution and proper handling procedures when lifting or moving to avoid personal injury. Use care to avoid contact with sharp or pointed edges.

Safety Precautions

- Always wear safety eye wear and work gloves when installing equipment.
- Never assume electrical power is disconnected. Check with meter and equipment.
- Keep hands out of fan areas when power is connected to equipment.
- R-410A causes frostbite burns.
- R-410A is toxic when burned.

NOTE TO INSTALLING DEALER: The Owners Instructions and Warranty are to be given to the owner or prominently displayed near the indoor Furnace/Air Handler Unit.

Special warnings

When wiring:

Electrical shock can cause severe personal injury or death. Only a qualified, experienced electrician should attempt to wire this system.

- Do not supply power to the unit until all wiring and tubing are completed or reconnected and checked.
- Highly dangerous electrical voltages are used in this system. Carefully refer to the wiring diagram and these instructions when wiring. Improper connections and inadequate grounding can cause accidental injury or death.
- Ground the unit following local electrical codes.
- Connect all wiring tightly. Loose wiring may cause overheating at connection points and a possible fire hazard.

When transporting:

Be careful when picking up and moving the indoor and outdoor units. Get a partner to help, and bend your knees when lifting to reduce strain on your back. Sharp edges or thin aluminum fins on the air conditioner can cut your finger.

When installing...

- ... **in a wall:** Make sure the wall is strong enough to hold the unit's weight. It may be necessary to construct a strong wood or metal frame to provide added support.
- ... **in a room:** Properly insulate any tubing run inside a room to prevent "sweating" that can cause dripping and water damage to wall and floors.
- ... **in moist or uneven locations:** Use a raised concrete pad or concrete blocks provide a solid, level foundation for the outdoor unit. This prevents water damage and abnormal vibration.
- ... **in an area with high winds:** Securely anchor the outdoor unit down with bolts and a metal frame. Provide a suitable air baffle.
- ... **in a snowy area(for Heat Pump Model):** Install the outdoor unit on a raised platform that is higher than drifting snow. Provide snow vents.

When connecting refrigerant tubing

- Keep all tubing runs as short as possible.
- Use the flare method for connecting tubing.
- Check carefully for leaks before starting the test run.

When servicing

- Turn the power OFF at the main power box(mains) before opening the unit to check or repair electrical parts and wiring.
- Keep your fingers and clothing away from any moving parts.
- Clean up the site after you finish, remembering to check that no metal scraps or bits of wiring have been left inside the unit being serviced.

TABLE OF CONTENTS

Installation Requirements	Required Parts	Required Tools
Features4		
Safety Precautions5		
Installation		
Selection the best location8	<ul style="list-style-type: none"> <input type="checkbox"/> Four type "A" screws <input type="checkbox"/> Connecting cable 	<ul style="list-style-type: none"> <input type="checkbox"/> Level gauge <input type="checkbox"/> Screw driver <input type="checkbox"/> Electric drill <input type="checkbox"/> Hole core drill
Ceiling opening dimension and hanging bolt location9	<ul style="list-style-type: none"> <input type="checkbox"/> Pipes: Gas side <li style="padding-left: 20px;">Liquid side (Refer to Product Data) <input type="checkbox"/> Insulation materials <input type="checkbox"/> Additional drain pipe 	<ul style="list-style-type: none"> <input type="checkbox"/> Flaring tool set <input type="checkbox"/> Specified torque wrenches (different depending on model No.) <input type="checkbox"/> SpannerHalf union
Indoor Unit Installation.....10		
Wiring Connection10		<ul style="list-style-type: none"> <input type="checkbox"/> A glass of water <input type="checkbox"/> Screw driver
Checking the Drainage.....11		<ul style="list-style-type: none"> <input type="checkbox"/> Hexagonal wrench <input type="checkbox"/> Gas-leak detector <input type="checkbox"/> Vacuum pump <input type="checkbox"/> Gauge manifold
Installation of Remote controller.....14		<ul style="list-style-type: none"> <input type="checkbox"/> Owner's manual <input type="checkbox"/> Thermometer
Optional Operation of Wired Remote Controller16		
Dip Switch Setting17		
Group Control Setting.....18		
How to Set E.S.P?21		

ENGLISH

Features

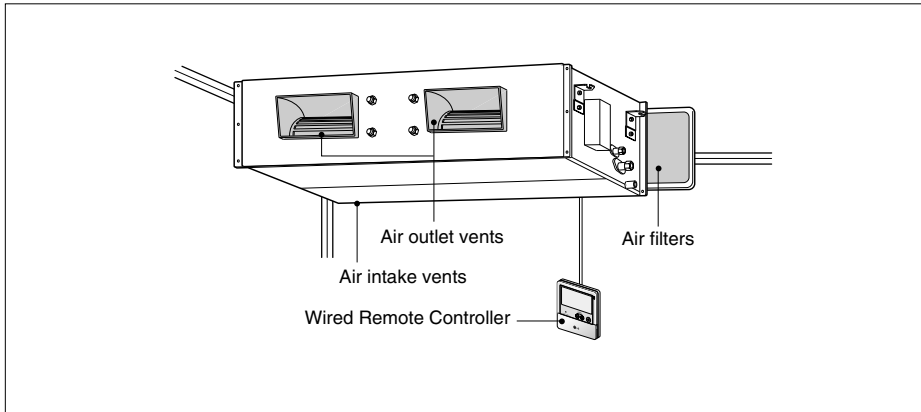

Safety Precautions

To prevent injury to the user or other people and property damage, the following instructions must be followed.

- Be sure to read before installing the air conditioner.
- Be sure to observe the cautions specified here as they include important items related to safety.
- Incorrect operation due to ignoring instruction will cause harm or damage. The seriousness is classified by the following indications.

⚠ WARNING This symbol indicates the possibility of death or serious injury.

⚠ CAUTION This symbol indicates the possibility of injury or damage to properties only.

■ Meanings of symbols used in this manual are as shown below.

	Be sure not to do.
	Be sure to follow the instruction.

⚠ WARNING

■ Installation

Do not use a defective or under-rated circuit breaker. Use this appliance on a dedicated circuit.

- There is risk of fire or electric shock.



For electrical work, contact the dealer, seller, a qualified electrician, or an Authorized Service Center.

- Do not disassemble or repair the product. There is risk of fire or electric shock.



Always ground the product.

- There is risk of fire or electric shock.

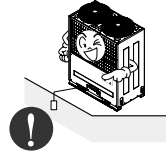

Install the panel and the cover of control box securely.

- There is risk of fire or electric shock.

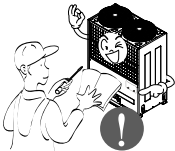

Always install a dedicated circuit and breaker.

- Improper wiring or installation may cause fire or electric shock.



Use the correctly rated breaker or fuse.

- There is risk of fire or electric shock.



ENGLISH

Safety Precautions

Do not modify or extend the power cable.

- There is risk of fire or electric shock.

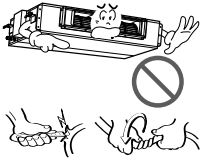

Do not let the air conditioner run for a long time when the humidity is very high and a door or a window is left open.

- Moisture may condense and wet or damage furniture.

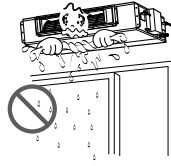

Be cautious when unpacking and installing the product.

- Sharp edges could cause injury. Be especially careful of the case edges and the fins on the condenser and evaporator.

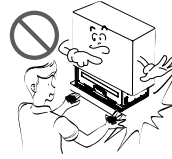

For installation, always contact the dealer or an Authorized Service Center.

- There is risk of fire, electric shock, explosion, or injury.



Do not install the product on a defective installation stand.

- It may cause injury, accident, or damage to the product.



Be sure the installation area does not deteriorate with age.

- If the base collapses, the air conditioner could fall with it, causing property damage, product failure, and personal injury.

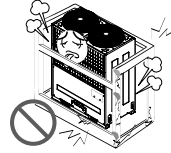

■ Operation

Do not store or use flammable gas or combustibles near the product.

- There is risk of fire or failure of product.



CAUTION

Installation

Always check for gas (refrigerant) leakage after installation or repair of product.

- Low refrigerant levels may cause failure of product.

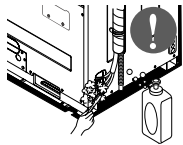

Install the drain hose to ensure that water is drained away properly.

- A bad connection may cause water leakage.

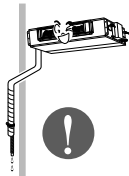

Keep level even when installing the product.

- To avoid vibration or water leakage.

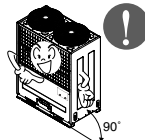

Do not install the product where the noise or hot air from the outdoor unit could damage the neighborhoods.

- It may cause a problem for your neighbors.



Use two or more people to lift and transport the product.

- Avoid personal injury.



Do not install the product where it will be exposed to sea wind (salt spray) directly.

- It may cause corrosion on the product. Corrosion, particularly on the condenser and evaporator fins, could cause product malfunction or inefficient operation.

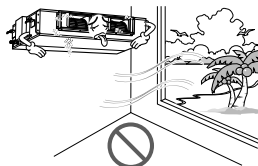

If you eat the liquid from the batteries, brush your teeth and see doctor. Do not use the remote if the batteries have leaked.

- The chemicals in batteries could cause burns or other health hazards.



ENGLISH

Installation

Read completely, then follow step by step.

Selection of the best location

Install the air conditioner in the location that satisfies the following conditions.

- The place shall easily bear a load exceeding four times the indoor unit's weight.
- The place shall be able to inspect the unit as the figure.
- The place where the unit shall be leveled.
- The place shall allow easy water drainage. (Suitable dimension "H" is necessary to get a slope to drain as figure.)
- The place shall easily connect with the outdoor unit.
- The place where the unit is not affected by an electrical noise.
- The place where air circulation in the room will be good.
- There should not be any heat source or steam near the unit.

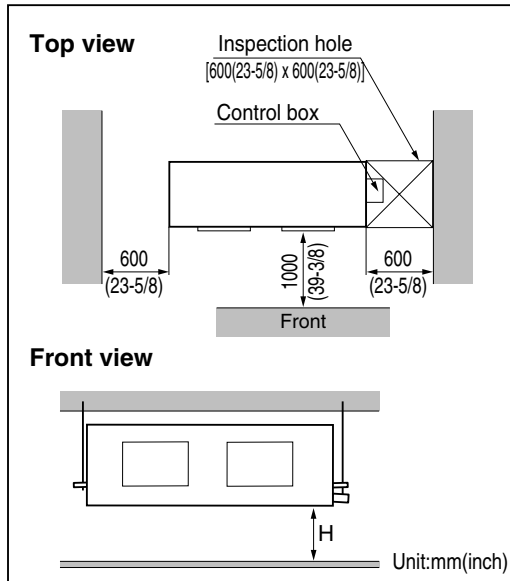

CAUTION : In case that the unit is installed near the sea, the installation parts may be corroded by salt, The installation parts (and the unit) should be taken appropriate anti-corrosion measures.

Ceiling dimension and hanging bolt location

■ Installation of Unit

Install the unit above the ceiling correctly.

CASE 1

POSITION OF SUSPENSION BOLT

- Apply a joint-canvas between the unit and duct to absorb unnecessary vibration.

[Unit:mm(inch)]

Dimension	A	B	C	D	E	F	(G)	H	I
Chassis									
BH	932 (36-9/13)	882 (34-11/16)	355 (13-5/8)	47 (1-3/4)	450 (17-11/16)	30 (1-3/16)	87 (3-5/8)	750 (29-1/2)	158 (6-3/13)
BG	1232 (48-7/13)	1182 (46-7/13)	355 (13-5/8)	47 (1-3/4)	450 (17-11/16)	30 (1-3/16)	87 (3-5/8)	830 (32-11/16)	186 (7-5/16)
BR	1282 (50-7/16)	1230 (48-5/8)	477 (18-13/16)	56 (2-3/13)	590 (23-3/16)	30 (1-3/16)	120 (4-9/13)	1006 (39-5/8)	294 (11-9/16)

[Unit:mm(inch)]

Dimension	A	B	C	D	E	F	G	H	I	J	K	L
Chassis												
B8	1600 (62-1/8)	1555 (61-5/8)	1180 (46-11/16)	330 (12-5/16)	450 (18-1/16)	580 (22-11/16)	700 (27-9/16)	1400 (55-1/8)	1635 (64-3/16)	300 (11-3/8)	445 (17-7/16)	15 (5/8)

CASE 2

- Install the unit leaning to a drainage hole side as a figure for easy water drainage.

POSITION OF CONSOLE BOLT

- A place where the unit will be leveled and that can support the weight of the unit.
- A place where the unit can withstand its vibration.
- A place where service can be easily performed.

NOTICE

- Thoroughly study the following installation locations:
 1. In such places as restaurants and kitchens, considerable amount of oil steam and flour adhere to the fan, the fin of the heat exchanger, resulting in heat exchange reduction, spraying, dispersing of water drops, etc. In these cases, take the following actions:
 - Make sure that the ventilation fan for smoke-collecting hood on a cooking table has sufficient capacity so that it draws oily steam which should not flow into the suction of the air conditioner.
 - Make enough distance from a cooking room to install the air conditioner in such a place where it may not suck in oil steam.
 2. Avoid installing air conditioner in such circumstances where cutting oil mist or iron powder is in suspension in factories, etc.
 3. Avoid places where inflammable gas is generated, flows in, is stored or vented.
 4. Avoid places where sulfurous acid gas or corrosive gas is generated.
 5. Avoid places near high frequency generators.

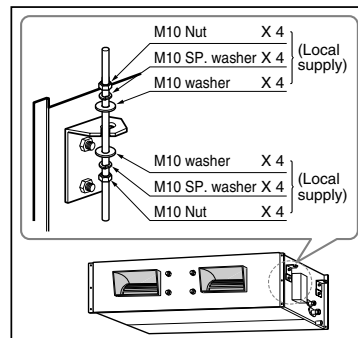
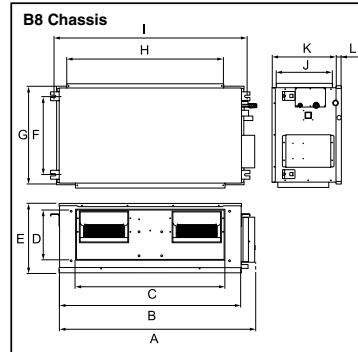
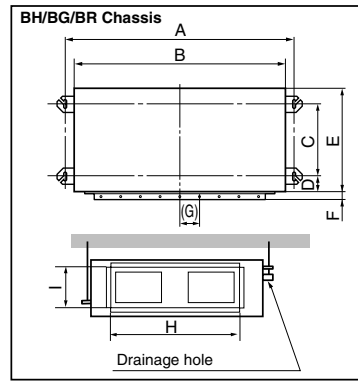

ENGLISH

Indoor Unit Installation

- Select and mark the position for fixing bolts.
- Drill the hole for set anchor on the face of ceiling.

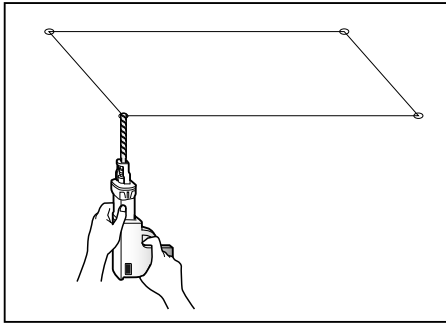

CAUTION : Tighten the nut and bolt to prevent unit falling.

- Insert the set anchor and washer onto the suspension bolts for locking the suspension bolts on the ceiling.
- Mount the suspension bolts to the set anchor firmly.
- Secure the installation plates onto the suspension bolts (adjust level roughly) using nuts, washers and spring washers.

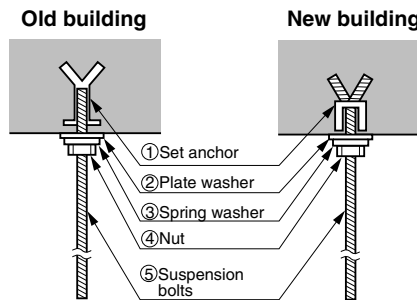

Wiring Connection

- Connect the wires to the terminals on the control board individually according to the outdoor unit connection.
- Ensure that the color of the wires of outdoor unit and the terminal No. are the same as those of indoor unit respectively.

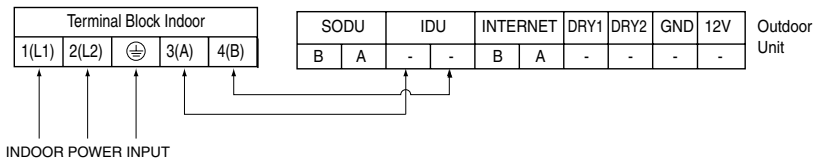

WARNING : Make sure that the screws of the terminal are free from looseness.

Clamping of cables

- 1) Arrange 2 power cables on the control panel.
- 2) First, fasten the steel clamp with a screw to the inner boss of control panel.
- 3) For the cooling model, fix the other side of the clamp with a screw strongly. For the heat pump model, put the 0.75mm² cable(thinner cable) on the clamp and tighten it with a plastic clamp to the other boss of the control panel.

Connection method of the connecting cable(Example)

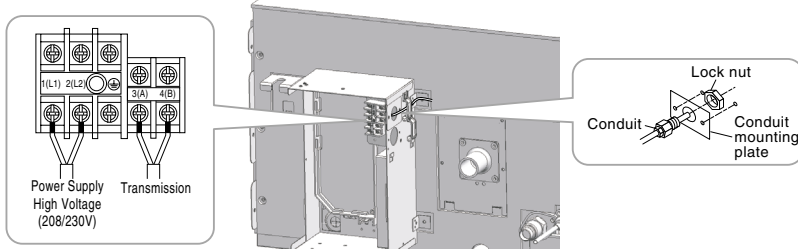

⚠ WARNING : Loose wiring may cause the terminal to overheat or result in unit malfunction.
 A fire hazzard may also exist.
 Therefore, be sure all wiring is tightly connected.

ENGLISH

INSULATION, OTHERS	Insulate the joint and tubes completely.
THERMAL INSULATION	All thermal insulation must comply with local requirement.
INDOOR UNIT	

Checking the Drainage

1. Remove the Air Filter.

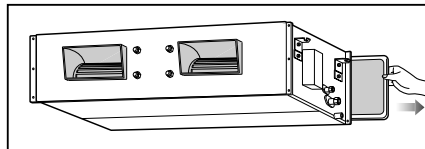

2. Check the drainage.

- Spray one or two glasses of water upon the evaporator.
- Ensure that water flows drain hose of indoor unit without any leakage.

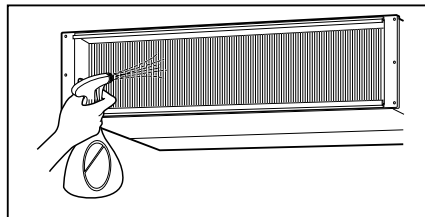

CAUTION

1. **Install declination** of the indoor unit is very **important for the drain** of the duct type air conditioner.
2. Minimum thickness of the insulation for the connecting pipe shall be 5mm.

Front of view

- The unit must be horizontal or declined to the drain hose connected when finished installation.

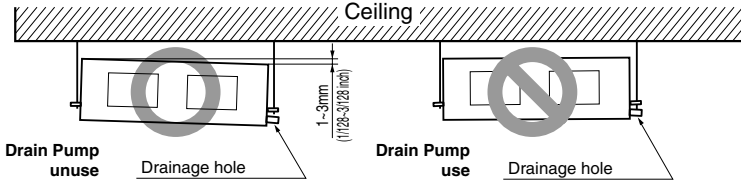

CAUTION FOR GRADIENT OF UNIT AND DRAIN PIPING

Lay the drain hose with a downware inclination so water will drain out.

- Always lay the drain with downward inclination (1/50 to 1/100). Prevent any upward flow or reverse flow in any part.
- 5mm(5/24 inch) or thicker formed thermal insulator shall always be provided for the drain pipe.

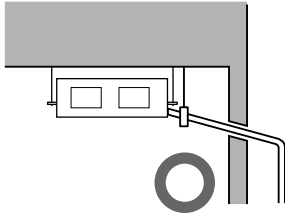
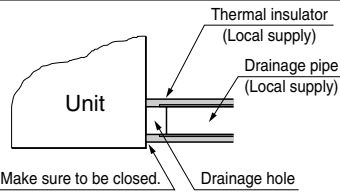

CORRECT

- Install the P-Trap (or U-Trap) to prevent a water leakage caused by the blocking of intake air filter.

- Upward routing not allowed

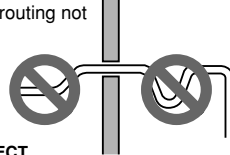

INCORRECT

Applied U-Trap Dimension

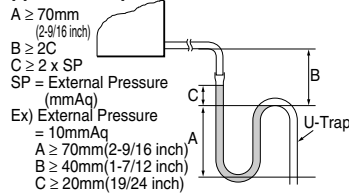



CAUTION:

After the confirmation of the above conditions, prepare the wiring as follows:

- 1) **Never fail to have an individual power specialized for the air conditioner. As for the method of wiring, be guided by the circuit diagram posted on the inside of control box cover.**
- 2) **Provide a circuit breaker switch between power source and the unit.**
- 3) **The screws which fasten the wiring in the casing of electrical fittings are liable to come loose from vibrations to which the unit is subjected during the course of transportation. Check them and make sure that they are all tightly fastened. (If they are loose, it could give rise to burn-out of the wires.)**
- 4) **Specification of power source**
- 5) **Confirm that electrical capacity is sufficient.**
- 6) **Be sure that the starting voltage is maintained at more than 90 percent of the rated voltage marked on the name plate.**
- 7) **Confirm that the cable thickness is as specified in the power sources specification. (Particularly note the relation between cable length and thickness.)**
- 8) **Never fail to equip a leakage breaker where it is wet or moist.**
- 9) **The following troubles would be caused by voltage drop-down.**
 - Vibration of a magnetic switch, damage on the contact point, fuse breaking, disturbance by the normal function of an overload protection device.
 - Proper starting power is not given to the compressor.

ENGLISH

HAND OVER

Teach the customer the operation and maintenance procedures, using the operation manual. (air filter cleaning, temperature control, etc.)

Installation of Wired Remote Controller

1. Connect the wired remote controller cable to the wired remote controller installation board as shown in the right picture.

12V	Red wire
SIG	Yellow wire
GND	Black wire

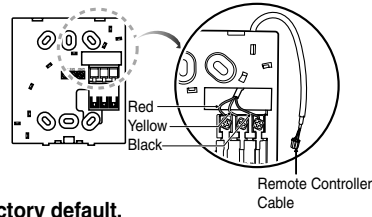

- * The wired remote controller cable is connected as factory default.

2. After fixing the cable to the guide slot, attach the wired remote controller installation board at the desired location.

- Before fixing the wired remote controller cable to the guide slot, remove any clogged part of the case in the direction to install before the installation.

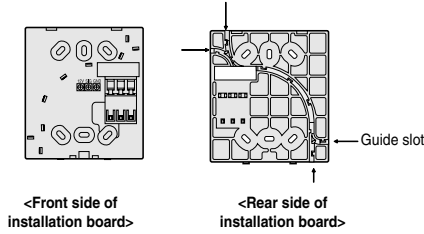

3. After locating the wired remote controller installation board at the desired location, screw the unit firmly. (When there is a buried box, install the wired remote controller board to fit the buried box.)

- Use the screw provided.

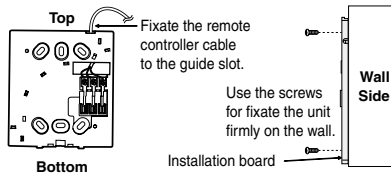

4. After fixing the top part of the wired remote controller to the installation board as shown in beside picture, press the bottom part to assemble the controller to its board.

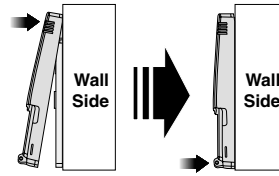

When disassemble the wired remote controller from the installation board, use the driver as shown in the right picture and insert it into the hole with the arrow. And when you pull the driver in the front direction, the wired remote controller will be separated.

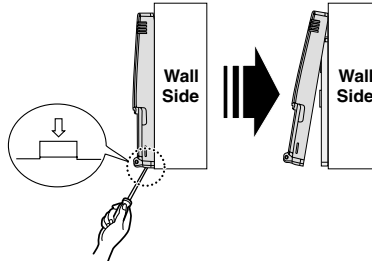

5. Use the connecting cable to connect the indoor unit and the wired remote controller.

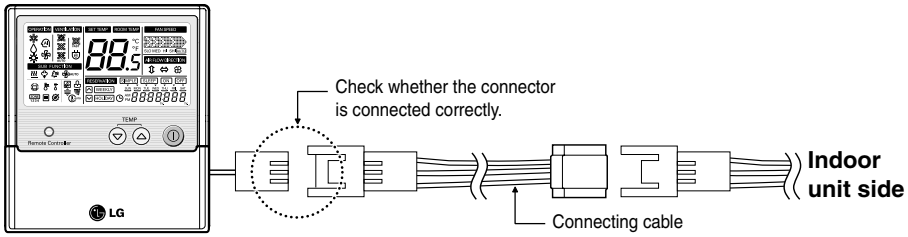

6. When the distance between the wired remote controller and the indoor unit is 10m and above, use the extension cable.

CAUTION

When installing the wired remote controller, do not bury it in the wall.

(It can cause damage in the temperature sensor.)

Do not install the cable to be 50m or above.

(It can cause communication error.)



- When installing the extension cable, check the connecting direction of the connector of the remote controller side and the product side for correct installation.
- If you install the extension cable in the opposite direction, the connector will not be connected.
- Specification of extension cable: 2547 1007 22# 2 core 3 shield 5 or above.

ENGLISH



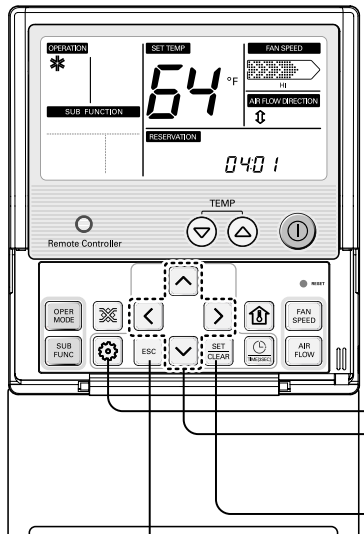

Optional Operation of Wired Remote Controller

Two Thermistor System

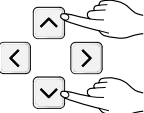
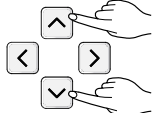

1. Press  button for 4 seconds to enter the installer setting mode until timer segment display "01:01". 
2. Repeat pressing  button to select Function code 04.

04:01

Function Code Thermistor setting
3. Set Thermistor mode by pressing   button (01: Remote Controller, 02: Indoor, 03: 2TH) 
4. Press  button to save or release 
5. Press  button to exit or system will automatically exit after 25 seconds without any input. 

* Therefore system will use value that sensed from indoor unit or remote controller

Temperature sensor location		Function
01	Remote controller	Operation in remote controller Temperature sensor
02	Indoor unit	Operation in indoor unit temperature sensor
03	2-Thermistor	Operation in lower temperature after comparing the temperature between the indoor unit and remote controller

* If you want to know more Optional Operation, please refer to Wired Remote Controller Manual.

Dip Switch Setting

	Function	Description	Setting Off	Setting On	Default
SW1	Communication	N/A (Default)	-	-	Off
SW2	Cycle	N/A (Default)	-	-	Off
SW3	Group Control	Selection of Master or Slave	Master	Slave	Off
SW4	Dry Contact Mode	Selection of Dry Contact Mode	Wired/Wireless remote controller Selection of Manual or Auto operation Mode	Auto	Off
SW5	Installation	CST – No function	-	-	Off
		Duct – Fan continuous operation	Continuous operation Removal	Working	
		CVT – Selection of ceiling or floor	Ceiling	Floor	
		Console – Concealed or not	General installation	Concealed installation	
SW6	Heater linkage	N/A	-	-	Off
SW7	Ventilator linkage	Selection of Ventilator linkage	Linkage Removal	Working	Off
	Vane selection (Console)	Selection of up/down side Vane	Up side + Down side Vane	Up side Vane Only	
SW8	Etc.	Spare	-	-	Off

CAUTION

For Multi V Models, Dip switch 1, 2, 6, 8 must be set OFF.
That dip switch is used for other models.

ENGLISH

Group Control Setting

1. Group Control 1

■ Wired remote controller 1 + Indoor units

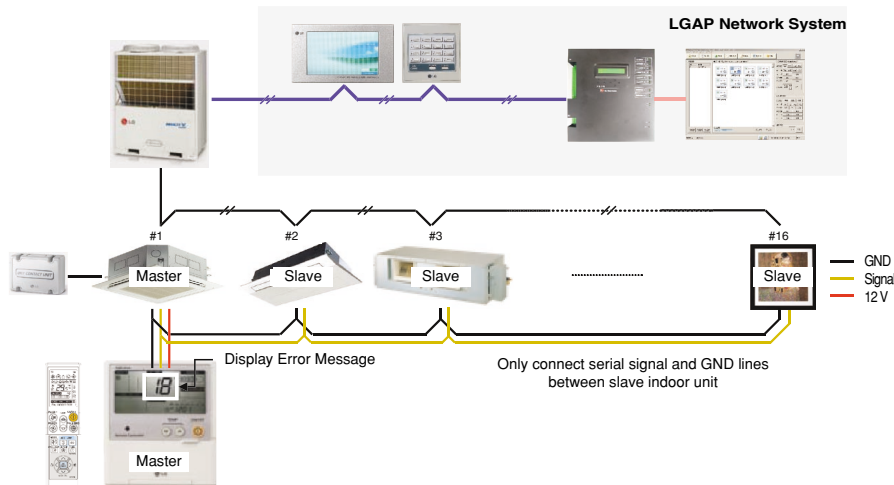

1. It is possible to 16 indoor units(Max) by one wired remote controller.

Set only one indoor unit to Master, set the others to Slave.

2. It is possible to connect with every type of indoor units.

3. It is possible to use wireless remote controller at the same time.

4. It is possible to connect with Dry Contact and Central controller at the same time.

The Master indoor unit is possible to recognize Dry Contact and Central controller only.

5. In case of any error occurs at indoor unit, display on the wired remote controller.

Exception of the error indoor unit, an individual indoor unit control possibility.

6. In case of Group Control, be limited additional functions of indoor unit.

- Selection of operation options (stop/mode/temperature)
- Control of flow rate (strong/middle/weak)
- Time reservation function
- Elevation grille

* All kind of indoor units be set possible using a wireless remote controller, except cassette and duct types. Refer to wireless remote controller manual for setting group control.

* It is possible to connect indoor units since Feb. 2009. In the other cases, please contact LGE.

2. Group Control 2

■ Wired remote controllers + Indoor units

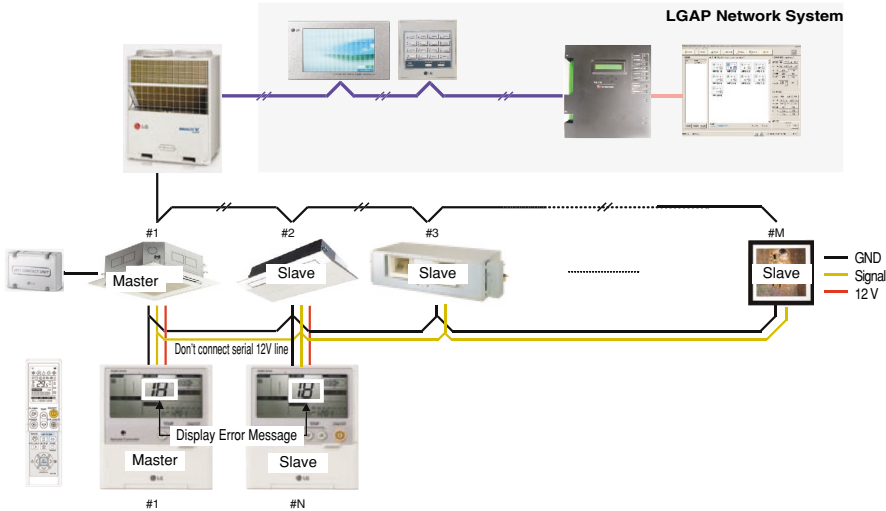

ENGLISH

1. It is possible to control N indoor units by wired remote controller M units. ($M+N \leq 17$ Units)

Set only one indoor unit to Master, set the others to Slave.

Set only one wired remote controller to Master, set the others to Slave.

Other than those, it is same with the Group Control 1.

2. It is possible to connect with every type of indoor units.

3. It is possible to use wireless remote controller at the same time.

4. It is possible to connect with Dry Contact and Central controller at the same time.

The Master indoor unit is possible to recognize Dry Contact and Central controller only.

5. In case of any error occurs at indoor unit, display on the wired remote controller.

Exception of the error indoor unit, an individual indoor unit control possibility.

6. In case of Group Control, be limited additional functions of indoor unit.

- Selection of operation options (stop/mode/temperature)
- Control of flow rate (strong/middle/weak)
- Time reservation function
- Elevation grille

* All kind of indoor units be set possible using a wireless remote controller, except cassette and duct types.
Refer to wireless remote controller manual for setting group control.

* It is possible to connect indoor units since Feb. 2009.
In the other cases, please contact LGE.

3.2 Remote Control

■ Wired remote controller 2 + Indoor unit 1

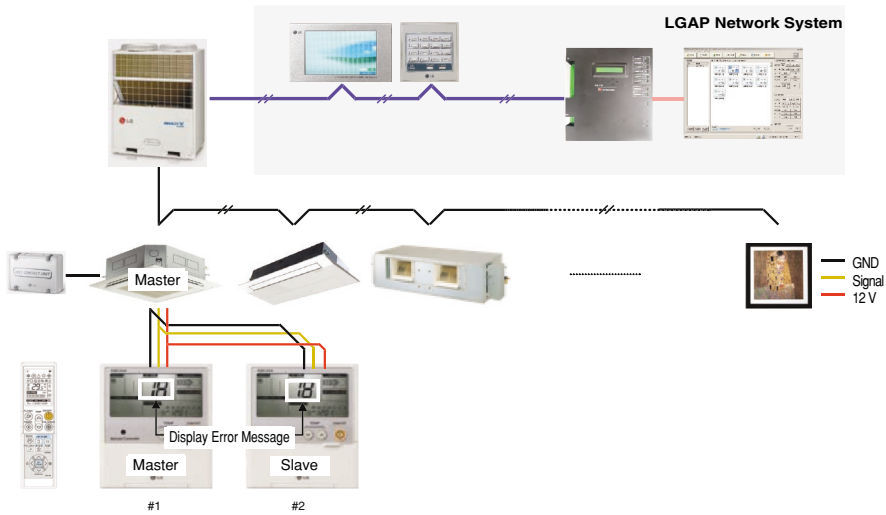

1. It is possible to connect two wired remote controllers with one indoor unit.
2. Every types of indoor unit is possible to connect two remote controller.
3. It is possible to use wireless remote controller at the same time.
4. It is possible to connect with Dry Contact and Central controller at the same time.
5. In case of any error occurs at indoor unit, display on the wired remote controller.
6. There isn't limits of indoor unit function.

How to Set E.S.P?



What is an E.S.P function?



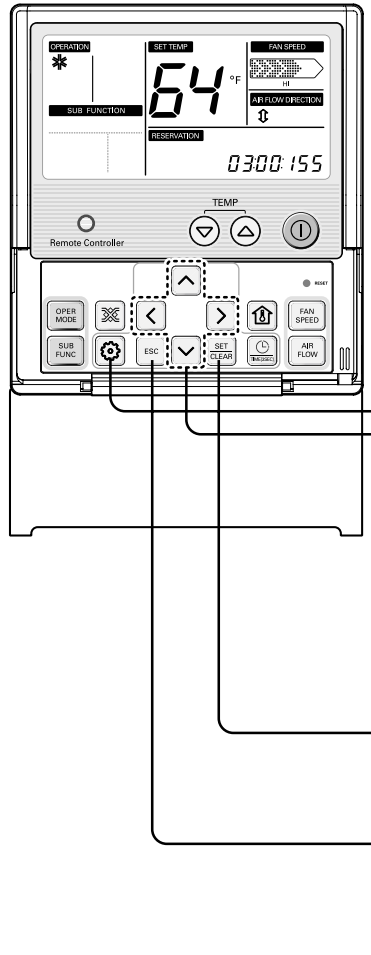

This is the function that decides the strength of the wind for each wind level and because this function is to make the installation easier, please do not use this function when using the remote controller.

CAUTION

If you set ESP incorrectly, the air conditioner may malfunction.
 This setting must be carried out by a certificated-technician.
 This function is using for only Duct product

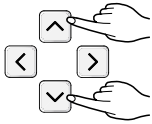
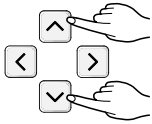
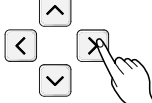
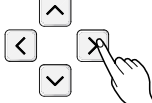
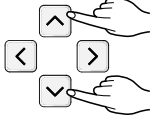
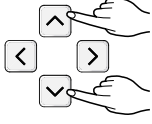

1. Press  button for 4 seconds to enter the installer setting mode until timer segment display "01:01". 
2. Repeat pressing Function Setting key to select Function code 03.

03:00:155
 ↓ ↓ ↓
 Function Code ESP step ESP value
3. Set ESP step by pressing  button (01: very low, 02: low, 03: medium, 04: high, 05: power). 
4. Move to ESP setting by pressing  button. 
5. Press  button to select ESP value(0~255). 
6. Press  button to save or release 
7. Press  button to exit or the system will automatically exit after 25 seconds without any input 

ENGLISH

- * Weak and Power setting is not available for some products.
- * Because the ESP value is already appropriately set when manufactured from the factory, it is recommended that you do not change the ESP value.

**ARNU073BHA2, ARNU093BHA2, ARNU123BHA2
ARNU153BHA2, ARNU183BHA2, ARNU243BHA2**

(Unit;cmm(cfm))

Setting Value	Static Pressure(mmAq (in.Aq))								
	3(0.12)	4(0.15)	5(0.19)	6(0.23)	7(0.27)	8(0.31)	9(0.35)	10(0.39)	12(0.47)
70	4.1(144)	-	-	-	-	-	-	-	-
80	7.6(268)	-	-	-	-	-	-	-	-
90	10.7(377)	8.1(286)	6.3(222)	4.9(173)	-	-	-	-	-
100	13.4(473)	11.2(395)	9.6(339)	7.5(264)	4(141)	-	-	-	-
110	15.9(561)	13.2(466)	12.6(444)	10.3(363)	7.7(271)	5.5(194)	-	-	-
120	18.6(656)	16.2(572)	15.2(536)	12.8(452)	11.1(392)	9.1(321)	6.7(236)	5.3(187)	-
130	19.8(699)	18.8(663)	18(635)	15.3(540)	14.2(501)	12.4(437)	10.4(367)	8.8(310)	5.7(201)
140	22.3(787)	21.1(745)	20.3(716)	17.7(625)	17.1(603)	15.5(547)	13.7(483)	12.6(444)	9.7(342)
145	23.2(819)	22.2(784)	21.4(755)	19.1(674)	18.4(649)	16.9(596)	15.3(540)	13.8(487)	11.8(416)
150	24.3(858)	23.1(815)	22.3(787)	21.1(745)	19.8(699)	18.3(646)	16.8(593)	15.2(536)	13(459)

ARNU283BGA2, ARNU363BGA2, ARNU423BGA2

(Unit;cmm(cfm))

Setting Value	Static Pressure(mmAq (in.Aq))								
	5(0.19)	6(0.23)	7(0.27)	8(0.31)	9(0.35)	10(0.39)	12(0.47)	14(0.55)	16(0.62)
70	-	-	-	-	-	-	-	-	-
80	4(141)	-	-	-	-	-	-	-	-
90	12.1(427)	6.9(243)	4.13(145)	-	-	-	-	-	-
100	17(600)	15.5(547)	11.01(388)	6.2(218)	4.2(148)	-	-	-	-
110	21.4(755)	19.6(692)	17.53(619)	14(494)	11.6(409)	6.6(233)	-	-	-
120	25.8(911)	24(847)	21.8(769)	19.8(699)	17.9(632)	14.6(515)	12.1(427)	-	-
130	30(1059)	28.5(1006)	26.93(951)	25.3(893)	23.4(826)	21.8(769)	18.1(639)	14.6(515)	11.3(399)
140	36(1271)	32.1(1133)	30.41(1073)	29(1024)	27.4(697)	25.9(914)	21.6(762)	17.8(628)	14.5(512)
143	37.5(1324)	33.9(1197)	32.1(1133)	30.7(1084)	28.8(1017)	27.2(960)	23(812)	20.1(709)	16.8(593)
150	41(1447)	38(1342)	36(1271)	34.5(1218)	32.1(1133)	30.1(1063)	26.3(928)	22.4(791)	18.2(642)
160	42.4(1497)	41.6(1469)	38.2(1349)	36.1(1274)	35(1236)	34.6(1221)	31.1(1098)	26.8(946)	23.3(822)

ARNU483BRA2

(Unit;cmm(cfm))

Setting Value	Static Pressure(mmAq (in.Aq))										
	5(0.19)	6(0.23)	8(0.31)	10(0.39)	12(0.47)	14(0.55)	15(0.59)	16(0.62)	17(0.66)	18(0.70)	20(0.78)
91	46.5(1642)	43.7(1543)	38.2(1349)	31.3(1105)	23.2(819)	14(494)	9(317)	3.7(130)	-	-	-
96	49.9(1762)	46.1(1628)	43(1518)	33.5(1183)	31.1(1098)	18.4(649)	13.7(483)	9(317)	2.6(91)	-	-
101	52.1(1839)	50.2(1772)	47.9(1691)	39.5(1395)	37.4(1320)	27.3(964)	25.2(889)	17.8(628)	8.9(314)	6.1(215)	-
106	51.4(1815)	51.2(1808)	50.4(1779)	44.4(1568)	43.1(1522)	33.3(1176)	32.1(1133)	28.9(1020)	21(741)	17.9(632)	8.3(293)
111	53.6(1892)	53.7(1896)	52.9(1868)	49.9(1762)	48.3(1705)	40.6(1433)	40.2(1419)	32.8(1158)	31.5(1112)	27.2(960)	17.5(618)
116	62.3(2200)	61(2154)	60.3(2129)	55.7(1967)	50.8(1794)	44.8(1582)	42.6(1504)	40.1(1416)	37.6(1327)	32.5(1147)	27.6(974)
121	67(2366)	64.8(2288)	64.1(2263)	58.2(2055)	52.2(1843)	50.8(1794)	50.3(1776)	45.7(1613)	44.6(1575)	38.8(1370)	32.2(1137)
126	68.2(2408)	67.5(2383)	66.2(2337)	65.1(2299)	64.3(2270)	57.4(2027)	54.4(1921)	51.2(1808)	50.4(1779)	46(1624)	43.5(1536)

Note: 1. The above table shows the correlation between the air rates and E.S.P.

URNU763B8A2, URNU963B8A2

(Unit;cmm (cfm))

Setting Value	Static Pressure(mmAq (in.Aq))								
	6(0.23)	9(0.35)	12(0.47)	15(0.59)	18(0.71)	20(0.79)	22(0.86)	23(0.90)	25(0.98)
60	40.5(1430)	-	-	-	-	-	-	-	-
65	52.7(1861)	-	-	-	-	-	-	-	-
70	63.7(2249)	47.1(1663)	-	-	-	-	-	-	-
75	71.1(2511)	56.9(2009)	44.7(1578)	-	-	-	-	-	-
80	76.3(2694)	69.7(2461)	55.2(1949)	-	-	-	-	-	-
85	83.3(2941)	78.6(2775)	67.4(2380)	55.9(1974)	-	-	-	-	-
91	89.7(3167)	87.1(3076)	78.9(2786)	67.6(2387)	54.2(1914)	-	-	-	-
95	93.4(3298)	91.4(3227)	86.1(3040)	77(2719)	66.4(2345)	50.6(1787)	30(1059)	-	-
100	93.4(3298)	91.4(3227)	88.3(3118)	84.9(2998)	75.9(2680)	69.5(2454)	60.8(2147)	43.1(1522)	-
105	93.2(3291)	91.3(3224)	88.3(3118)	84.9(2998)	81.1(2864)	77.4(2733)	69.2(2443)	67.9(2398)	51.3(1811)

Note: 1. The above table shows the correlation between the air rates and E.S.P.

ENGLISH



P/No.: MFL42803116

Printed in Korea

After reading this manual, keep it in a place easily accessible to the user for future reference.