

This Owner's Manual is provided and hosted by [Appliance Factory Parts](#).



PANASONIC NN-S780WA Owner's Manual

[Shop genuine replacement parts for PANASONIC
NN-S780WA](#)



[Find Your PANASONIC Microwave Parts - Select From 742 Models](#)

----- Manual continues below -----

Panasonic®

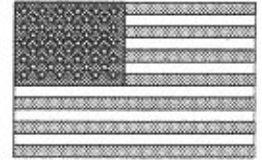

Operating Instructions

Microwave Oven
Model - NN-S780BA/BAS/WA/WAS

INVERTER
SYSTEM INSIDE

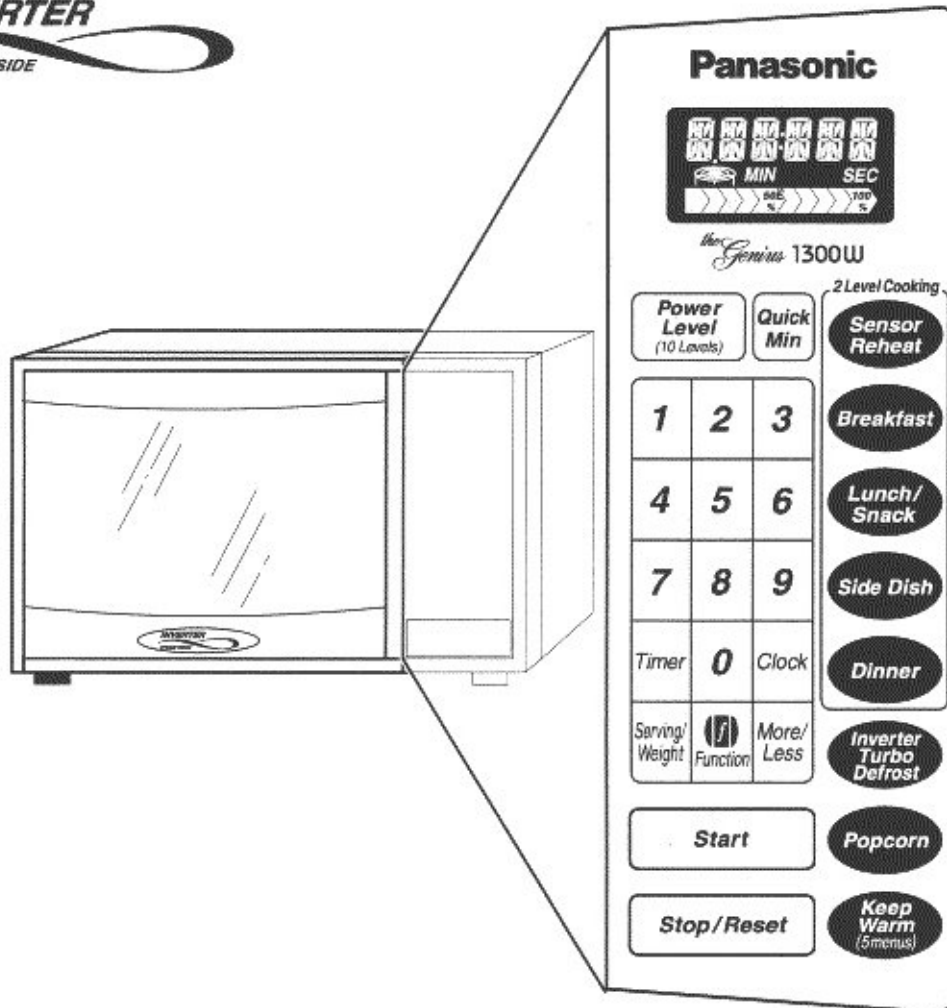

FOR ASSISTANCE:

Please call 1-800-211-PANA(7262)

-E-MAIL TO:
consumerproducts@panasonic.com

-REFER TO:
<http://www.Panasonic.com>

This manual contains Safety Instructions, Operating Instructions and Maintenance of the oven.

For Cooking Guide and Parts Information, see page 6.

Before operating this oven, please read these instructions completely.

Panasonic Consumer Electronics
Company, Division of Matsushita
Electric Corporation of America
One Panasonic Way
Secaucus, New Jersey 07094

B00034W00AP
DK-0002-0
Printed in U.S.A.

Thank you for purchasing the Panasonic Microwave Oven.
Please read the instructions completely.
Let's Start to Use Your Oven!—page 9.

PRECAUTIONS TO AVOID POSSIBLE EXPOSURE TO EXCESSIVE MICROWAVE ENERGY

- (a) Do not attempt to operate this oven with the door open since open-door operation can result in harmful exposure to microwave energy. It is important not to defeat or tamper with the safety interlocks.
- (b) Do not place any object between the oven front face and the door or allow soil or cleaner residue to accumulate on sealing surfaces.
- (c) Do not operate the oven if it is damaged. It is particularly important that the oven door close properly and that there is no damage to the:
 - (1) door (bent),
 - (2) hinges and latches (broken or loosened),
 - (3) door seals and sealing surfaces.
- (d) The oven should not be adjusted or repaired by anyone except properly qualified service personnel.

STAPLE YOUR STORE RECEIPT HERE.

If you have any questions or it seems there is a problem with the oven, contact **PANASONIC / QUASAR / TECHNICS Customer Call Center** for assistance, 1-800-211-PANA(7262) {9 a.m. - 9 p.m., E.S.T., toll free}.

The serial number of this product may be found on the right side of the oven door opening. You should note the model number and the serial number of this oven in the space provided and retain this book as a permanent record of your purchase for future reference.

Model No. _____

Serial No. _____

Date of Purchase _____

TABLE OF CONTENTS

Before Operating

| | |
|--|--------------------|
| Precautions | Inside Front Cover |
| Important Safety Instructions | 2 |
| Installation Instructions and Grounding Instructions | 3 |
| Safety Precautions | 4 |
| Cookware and Utensil Guide | 5 |
| Feature Diagram | 7 |
| Control Panel | 7 |

Operation

| | |
|---|---------|
| Function Pad | 8 |
| Let's Start to Use Your Oven! | 9 |
| Setting the Clock | 9 |
| Quick Min | 9 |
| Keep Warm | 9 |
| Power & Time Setting | 10 |
| Using the Timer | 10 |
| Popcorn | 11 |
| Inverter Turbo Defrost & Conversion Chart | 11 |
| Sensor Reheat | 12 |
| Sensor Cook Pad | 12 |
| Two Level Cooking | 15 - 16 |
| Recipes | 17 - 19 |

Cooking Tips

| | |
|------------------------------------|---------|
| Defrosting Tips & Techniques | 13 |
| Microwave Shortcuts | 14 |
| Sensor Cooking Chart | 15-16 |
| Food Characteristics | 20 |
| Cooking Techniques | 20 - 21 |

Maintenance

| | |
|-----------------------------------|---------------------|
| Care of Your Microwave Oven | 6 |
| Before Requesting Service | 22 |
| Warranty | 23 |
| Technical Specifications | Bottom of this page |
| Quick Guide to Operation | 24 |

Technical Specifications

| | |
|--|--|
| | NN-S780 |
| Power source: | 120V, 60 Hz |
| Power consumption: | 12.0 Amps 1,400 W |
| Output*: | 1300 W |
| Outside Dimensions: (H x W x D) | 11 ¹⁵ / ₁₆ " (H) X 21 ⁷ / ₈ " (W) X 19 ⁷ / ₁₆ " (D) 304mm (H) X 555mm (W) X 497mm (D) |
| Oven Capacity Dimensions: (H x W x D) | 9" (H) x 16 ⁷ / ₁₆ " (W) X 18 ¹ / ₂ " (D) 228mm (H) x 418mm (W) X 470mm (D) |
| Operating Frequency: | 2,450 MHz |
| Uncrated Weight (Approx.): | 32 lbs (14.3 kg) |

Specifications subject to change without notice.

*IEC 705-88 Test procedure

IMPORTANT SAFETY INSTRUCTIONS

Your microwave oven is a cooking device and you should use as much care as you use with a stove or any other cooking device. When using this electric appliance, basic safety precautions should be followed, including the following:

WARNING—To reduce the risk of burns, electric shock, fire, injury to persons or exposure to excessive microwave energy:

1. Read all instructions before using the appliance.
2. Read and follow the specific **“PRECAUTIONS TO AVOID POSSIBLE EXPOSURE TO EXCESSIVE MICROWAVE ENERGY,”** found on back of the front cover.
3. This appliance must be grounded. Connect only to properly grounded outlet. See **“GROUNDING INSTRUCTIONS”** found on page 3.
4. Install or locate this appliance only in accordance with the installation instructions found on page 3.
5. Do not cover or block any openings on this appliance.
6. Do not store or use this appliance outdoors. Do not use this product near water—for example, near a kitchen sink, in a wet basement, or near a swimming pool, and the like.
7. Use this appliance only for its intended use as described in this manual. **DO NOT** use corrosive chemicals, vapours, or non-food products in this appliance. This type of oven is specifically designed to heat or cook. It is not designed for industrial or laboratory use. The use of corrosive chemicals in heating or cleaning will damage the appliance and may result in radiation leaks.
8. When cleaning surfaces of door and oven that come together on closing the door, use only mild, non-abrasive soaps or detergents applied with a sponge or soft cloth.
9. Do not allow children to use this appliance, unless closely supervised by an adult.
10. Do not operate this appliance if it has a damaged cord or plug, if it is not working properly, or if it has been damaged or dropped.
11. Do not immerse cord or plug in water.
12. Keep cord away from heated surfaces.
13. Do not let cord hang over edge of a table or counter.
14. This appliance should be serviced only by qualified service personnel. Contact the nearest authorized servicer for examination, repair or adjustment.
15. Some products such as whole eggs, narrow neck bottles and sealed containers—for example, closed glass jars—may explode and should not be heated in this oven.
16. To reduce the risk of fire in the oven cavity:
 - (a) Do not overcook food. Carefully attend appliance if paper, plastic, or other combustible materials are placed inside the oven to facilitate cooking.
 - (b) Remove wire twist-ties from paper or plastic bags before placing bag in oven.

(c) If materials inside the oven should ignite, keep oven door closed, turn oven off, and disconnect the power cord, or shut off power at the fuse or circuit breaker panel.

(d) Do not use the cavity for storage purposes. Do not leave paper products, cooking utensils, or food in the cavity when not in use.

General Use

1. **DO NOT** tamper with or make any adjustments or repairs to door, control panel housing, safety interlock switches or any other part of the oven. **DO NOT** remove outer panel from oven. Repairs must be done only by a qualified service person.

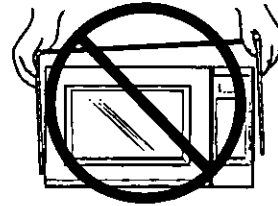

2. **DO NOT** operate the oven empty. The microwave energy will reflect continuously throughout the oven causing overheating, if food or water is not present to absorb energy. This could damage the oven and result in a risk of fire.

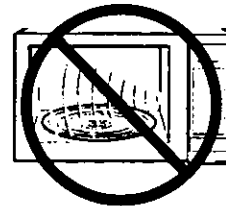

3. **DO NOT** dry clothes, newspapers or other materials in oven, or use newspapers or paper bags for cooking. Fire could result.
4. **DO NOT** use recycled paper products unless the paper product is labelled as safe for microwave oven use. Recycled paper products may contain impurities which may cause sparks, and result in fires when used.
5. **DO NOT** hit or strike control panel. Damage to controls may occur. Fire could result.
6. **POT HOLDERS** should always be used when removing items from the oven. Heat is transferred from the **HOT** food to the cooking container and from the cooking container to the Glass Tray. The Glass Tray can be very **HOT** after removing cooking container from oven.
7. **DO NOT** store flammable materials next to, on top of, or in the oven. These could be fire hazards.

SAVE THESE INSTRUCTIONS

For proper use of your oven read remaining safety cautions and operating instructions.

INSTALLATION & GROUNDING INSTRUCTIONS

Examine Your Oven

Unpack oven, remove all packing material and examine the oven for any damage such as dents, broken door latches or cracks in the door. Notify dealer immediately if oven is damaged. **DO NOT** install if oven is damaged.

Placement of Oven

1. Oven must be placed on a flat, stable surface. For proper operation, the oven must have sufficient air flow. Allow 3-inches (7.6 cm) of space on both sides of the oven and 1-inch (2.5 cm) of space on top of oven.
 - a. **DO NOT** block air vents. If they are blocked during operation, the oven may overheat. If the oven overheats, a thermal safety device will turn the oven off. The oven will remain inoperable. The oven should be taken to a Service Center.
 - b. **DO NOT** place oven near a hot, damp surface such as a gas or electric range.
 - c. **DO NOT** operate oven when room humidity is too high.
2. This oven was manufactured for household use only.

Grounding Instructions

This appliance must be grounded. In the event of an electrical short circuit, grounding reduces the risk of electric shock by providing an escape wire for the electric current. This appliance is equipped with a cord having a grounding wire with a grounding plug. The plug must be plugged into an outlet that is properly installed and grounded.

WARNING—Improper use of the grounding plug can result in a risk of electric shock.

Consult a qualified electrician or service person if the grounding instructions are not completely understood or if doubt exists as to whether the appliance is properly grounded. If it is necessary to use an extension cord, use only a three wire extension cord that has a three blade grounding plug, and a three slot receptacle that will accept the plug on the appliance. The marked rating of the extension cord should be equal to or greater than the electrical rating of the appliance.

Power Supply

1. A short power-supply cord is provided to reduce the risks resulting from becoming entangled in or tripping over a longer cord.
2. Longer cord sets or extension cords are available and may be used if care is exercised in their use.
3. If a long cord or extension cord is used, (a) the marked electrical rating of the cord set or extension cord should be at least as great as the electrical rating of the appliance, (b) the extension cord must be a grounding-type 3-wire cord, and (c) the longer cord should be arranged so that it will not drape over the counter top or tabletop where it can be pulled on by children or tripped over accidentally.

Wiring Requirements

1. The oven must be on a SEPARATE CIRCUIT. No other appliance should share the circuit with the microwave oven. If it does, the branch circuit fuse may blow, the circuit breaker may trip, or the food may cook slower than the times recommended in this manual.
2. The VOLTAGE used must be the same as specified on this microwave oven (120 V, 60 Hz). Using a higher voltage is dangerous and may result in a fire or other incident causing oven damage. Using a lower voltage will cause slow cooking. Panasonic is **NOT** responsible for damage resulting from the use of the oven with other than specified voltage.
3. The oven must be plugged into at least a 20 AMP, 120 VOLT, 60 Hz GROUNDED OUTLET. Where a standard two-prong outlet is encountered, it is the personal responsibility and obligation of the consumer to have it replaced with a properly grounded three-prong outlet.

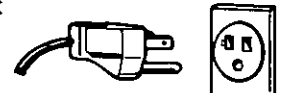

TV / Radio Interference

1. Operation of the microwave oven may cause interference to your radio, TV or similar equipment.
2. When there is interference, it may be reduced or eliminated by taking the following measures:
 - a. Clean door and sealing surfaces of the oven. (See Care of Your Microwave Oven)
 - b. Place the radio, TV, etc. away from the microwave oven as far as possible.
 - c. Use a properly installed antenna to obtain stronger signal reception.

Glass Tray

1. **DO NOT** operate the oven without Roller Ring and Glass Tray in place.
2. **DO NOT** operate the oven without the Glass Tray fully engaged on the drive hub. Improper cooking or damage to the oven could result. Verify that the Glass Tray is properly engaged and rotating by observing its rotation when you press **Start**.
3. Only use Glass Tray specifically designed for this oven. Do not substitute any other glass tray.
4. If Glass Tray is hot, allow to cool before cleaning or placing in water.
5. **DO NOT** cook directly on Glass Tray. Always place food in a microwave-safe dish, or on a rack set in a microwave-safe dish.
6. If food or utensil on Glass Tray touches oven walls, causing the tray to stop moving, the tray will automatically rotate in opposite direction. This is normal.
7. Glass Tray can turn in either direction.

Roller Ring

1. Roller Ring and oven floor should be cleaned frequently to prevent excessive noise.
2. Roller Ring must always be used for cooking along with Glass Tray.
3. Always replace Roller Ring and Glass Tray in their proper positions.

Safety Precautions

Follow These Safety Precautions When Cooking in Your Oven

IMPORTANT

Proper cooking depends upon the power, the time set and the quantity of food. If you use a smaller portion than recommended and cook at the time for the recommended portion, fire could result.

1) HOME CANNING / DRYING FOODS / SMALL QUANTITIES OF FOODS

- **DO NOT** use your oven for home canning, your oven cannot maintain the food at the proper canning temperature. Improperly canned food may spoil and may be dangerous to consume.
- **DO NOT** dry meats, herbs, fruits or vegetables in your oven. Small quantities of food or foods with low moisture content can dry out, scorch or catch on fire if overheated.

2) POPCORN

Popcorn may be popped in a microwave oven corn popper. Microwave popcorn which pops in its own package is also available. Follow popcorn manufacturers' directions and use a brand suitable for the wattage of your microwave oven.

CAUTION:

When using pre-packaged microwave popcorn, follow recommended package instructions. Check package weight before using the *Popcorn pad* (see *Popcorn Pad* section). Set the oven for the weight of the popcorn package.

If these instructions are not followed, the popcorn may not pop adequately or may ignite and cause a fire. Never leave oven unattended when popping popcorn. Allow the popcorn bag to cool before opening, always open the bag away from your face and body to prevent steam burns.

3) DEEP FAT FRYING

- **DO NOT** attempt to deep fat fry in your microwave oven. Cooking oils may burst into flames and may cause damage to the oven and perhaps result in burns. Microwave utensils may not be able to withstand the temperature of the hot oil, and could shatter or melt.

4) FOODS WITH NONPOROUS SKINS

- Potatoes, apples, whole eggs, egg yolks, whole squash and sausages are examples of foods with nonporous skins. These types of foods must be pierced before microwave cooking to prevent their bursting.
- Use fresh potatoes for baking and cook until just done. Use recommended weights for programmed cooking. Overcooking causes dehydration and may result in a fire.

5) LIQUIDS

- Heated liquids can erupt if not mixed with air. **DO NOT** heat liquids in your microwave oven without first stirring. Overheated liquids will erupt.

6) GLASS TRAY / COOKING UTENSILS / FOIL

- Cooking utensils get hot during microwaving. Heat is transferred from the HOT food to the container and the Glass Tray. Use potholders when removing utensils from the oven or when removing lids or plastic wrap covers from cooking utensils to avoid burns.
- The Glass Tray will get hot during cooking. It should be allowed to cool before handling or before paper products, such as paper plates or microwave popcorn bags, are placed in the oven for microwave cooking.
- When using foil, skewers, warming rack or utensils made of metal in the oven, allow at least 1-inch (2.5 cm) of space between metal material and interior oven walls. If arcing occurs (sparking), remove metal material (skewers, etc.) and/or transfer to a non-metallic container.
- Dishes with metallic trim should **not** be used, as arcing may occur.
- If an entree is heated in a foil tray, maintain at least 1-inch (2.5 cm) spacing from the oven walls.

7) PAPER TOWELS / CLOTHS

- **DO NOT** use paper towels or cloths which contain a synthetic fiber woven into them. The synthetic fiber may cause the towel to ignite. Use paper toweling under supervision.

8) BROWNING DISHES / OVEN COOKING BAGS

- Browning dishes or grills are designed for microwave cooking only. Always follow instructions provided by the manufacturer. **DO NOT** preheat browning dish more than 6 minutes.
- If an oven cooking bag is used for microwave cooking, prepare according to package directions. **DO NOT** use a wire twist-tie to close bag, instead use plastic ties, cotton string or a strip cut from the open end of the bag.

9) THERMOMETERS

- **DO NOT** use a conventional meat thermometer in your oven. Arcing may occur. Microwave-safe thermometers are available for both meat and candy.

10) BABY FORMULA / FOOD

- **DO NOT** heat baby formula or food in the microwave oven. The glass jar or surface of the food may appear to be only warm while the interior can be so hot as to burn the infant's mouth and esophagus.

11) REHEATING PASTRY PRODUCTS

- When reheating pastry products, check temperatures of any fillings before eating. Some foods have fillings which heat faster and can be extremely hot, while the surface remains warm to the touch (ex. Jelly Donuts).

12) GENERAL OVEN USAGE GUIDELINES

- **DO NOT** use the oven for any reason other than the preparation of food.
- **DO NOT** leave oven unattended while in use.

Cookware and Utensil Guide

| ITEM | MICROWAVE | COMMENTS |
|---|-------------------------|--|
| Aluminum Foil | Yes, for Shielding only | Small strips of foil can be molded around thin parts of meat or poultry to prevent overcooking. Arcing can occur if foil is too close to oven wall or if too much foil is used. |
| Browning Dish | Yes | Browning dishes are designed for microwave cooking only. Check browning dish information for instructions and heating chart. Do not preheat for more than 6 minutes. |
| Brown paper bags | No | May cause a fire in the oven. |
| Dinnerware Labeled "Microwave-Safe" | Yes | Check manufacturers' use and care directions for use in microwave heating. Some dinnerware may state on the back of the dish, "Oven-Microwave Safe". |
| Other Dinnerware | ? | Use CONTAINER TEST below. |
| Disposable polyester Paperboard Dishes | Yes | Some frozen foods are packaged in these dishes. Can be purchased in grocery stores. |
| Fast Food Carton with Metal Handle | No | Metal handle may cause arcing. |
| Frozen Dinner Tray Metal | Yes | Frozen dinners may be heated in foil tray, if tray is less than 3/4-inch (2 cm) high. Place foil tray in center of oven. Leave at least 1-inch (2.5 cm) space between foil tray and oven walls. Heat only 1 foil tray in the oven at a time. |
| Microwave-safe | Yes | For containers more than 3/4-inch (2 cm) deep, remove food and place in a similar size microwave-safe container. |
| Glass Jars | Yes, use caution | Remove lid. Heat food until just warm, not HOT. Most glass jars are not heat resistant. Do not use for cooking. |
| Glassware Heat Resistant Oven Glassware & Ceramics | Yes | Ideal for microwave cooking and browning. (See CONTAINER TEST below). |
| Metal Bakeware | No | Not recommended for use in microwave ovens. |
| Metal Twist-Ties | No | May cause arcing which could cause a fire in the oven. |
| Oven Cooking Bag | Yes | Follow manufacturers' directions. Close bag with the nylon tie provided, a strip cut from the end of the bag or a piece of cotton string. Do not close with metal twist-tie. Make six 1/2-inch (1 cm) slits near the closure. |
| Paper Plates & Cups | Yes | Use to warm cooked foods and to cook foods that require short cooking times such as hot dogs. |
| Paper Towels & Napkins | Yes | Use to warm rolls and sandwiches by microwave. |
| Parchment Paper | Yes | Use as a cover to prevent spattering. Safe for use in microwave, microwave/convection and conventional ovens. |
| Plastic Microwave-Safe Cookware | Yes | Should be labeled, "Suitable for Microwave Heating." Check manufacturers' directions for recommended uses. |
| Reheat & Storage | Yes, use caution | Some microwave-safe plastic dishes are not suitable for cooking foods with high fat or sugar content. The heat from hot food may cause the plastic to warp. |
| Melamine | No | This material absorbs microwave energy. Dishes get HOT! |
| Plastic Foam Cups | Yes | Plastic foam will melt if foods reach a high temperature. Use to bring foods to a low serving temperature. |
| Plastic Wrap | Yes | Use to cover food during cooking to retain moisture and prevent spattering. Should be labeled "Suitable for Microwave Heating". Check package directions. |
| Straw, Wicker, Wood | Yes | Use only for short term reheating and to bring food to a low serving temperature |
| Thermometers Microwave-safe, only | Yes | Use only microwave-safe meat and candy thermometers. |
| Conventional | No | Not suitable for use in microwave oven, will cause sparks and get hot. |
| Wax paper | Yes | Use as a cover to prevent spattering and to retain moisture. |

CONTAINER TEST

TO TEST A CONTAINER FOR SAFE MICROWAVE OVEN USE: Fill a 1-cup glass measure with water and place it in the microwave oven along with the container to be tested; **heat one (1) minute at P10 (HIGH)**. If the container is microwave oven-safe (transparent to microwave energy), the container should remain comfortably cool and the water should be hot. If the container is hot, it has absorbed some microwave energy and should NOT be used. This test cannot be used for plastic containers.

Care of Your Microwave Oven

BEFORE CLEANING:

Unplug at socket of the oven. If impossible, leave oven door open to prevent oven from accidentally turning on.

AFTER CLEANING:

Be sure to replace the Roller Ring and Glass Tray in the proper position and press **Stop/Reset** Pad to clear the screen.

Inside of the oven:

Wipe with a damp cloth. Mild detergent may be used if the oven gets very dirty. The use of harsh detergents or abrasives is not recommended.

Glass Tray:

Remove and wash in warm, soapy water or in a dishwasher.

Outside oven surfaces.

Clean with a damp cloth. To prevent damage to the operating parts inside the oven, water should not be allowed to seep into ventilation openings.

Menu Label:

Do not remove. Wipe with damp cloth.

Control Panel:

* Covered with a removable protective film to prevent scratches during shipping. Small bubbles may appear under this film. (Hint - To remove film, apply masking or clear tape to an exposed corner and pull gently.)
* If the control panel becomes wet, clean it with a soft dry cloth. Do not use harsh detergents or abrasives on the Control Panel.

2 Level Cooking Rack:

Wash in mild, soapy water.



Oven Door:

* Wipe with a soft cloth when steam accumulates inside or around the outside of the oven door. During cooking, especially under high humidity conditions, steam is given off from food. (Some steam will condense on cooler surfaces, such as the oven door. This is normal.)
* Inside surface is covered with a heat and vapor barrier film. Do not remove.

Roller Ring and oven cavity floor:

Wipe the bottom surface of the oven with mild detergent water or window cleaner and dry. Roller Ring may be washed in mild soapy water or dishwasher. These areas should be kept clean to avoid excessive noise.

NOTES

For more information regarding microwave cooking, order our new **COOKING GUIDE** (68 pages of recipes & charts).

| DESCRIPTION | PART NUMBER | PRICE |
|---|-------------|-------|
| Instruction/Operating Manual (this book) | B00034W00AP | ① |
| COOKING GUIDE | B000B8250AP | ① |
| Glass Tray (see Care of Your Microwave Oven above) | B06014W00AP | ① |
| Roller Ring Assembly | B290D4M00AP | ① |
| 2 Level Cooking Rack | B060X4P00AP | ① |

For pricing quotes, call or write the Parts & Literature Department at the phone or address listed below. Please have your credit card information readily available.

Shipping & handling are not included. Price & availability subject to change. Sorry, no COD's.

PANASONIC SERVICES COMPANY

20421 84th Avenue South
Kent, WA 98032

(800) 833-9626 - Phone
(800) 237-9080 - FAX

Feature Diagram

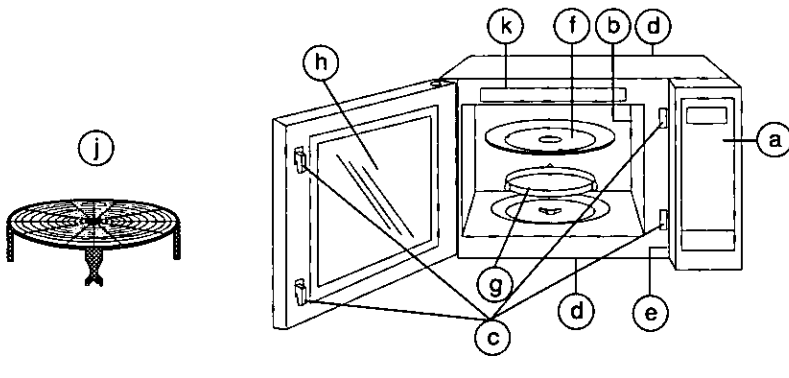

- (a) Control Panel
- (b) Internal Air Vents
- (c) Door Safety Lock System
- (d) External Air Vents
- (e) Identification Plate
- (f) Glass Tray
- (g) Roller Ring
- (h) Heat/Vapor Barrier Film (do not remove)
- (j) Two-Level Cooking Rack
- (k) Menu Label

Control Panel

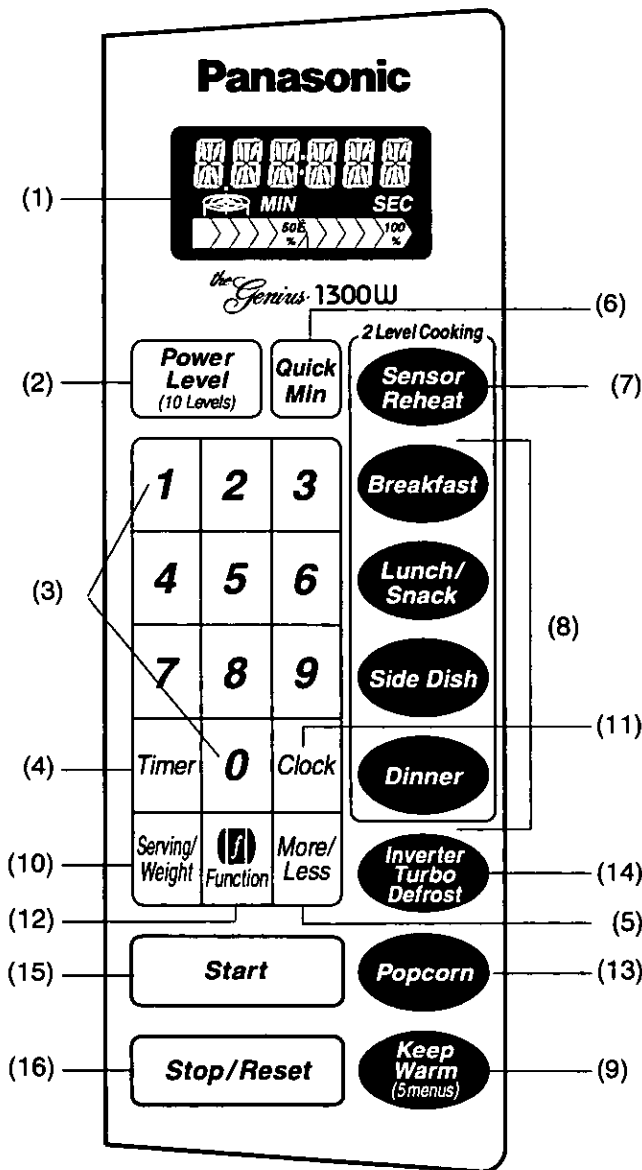

(1) Display Window

Step by step instructions scroll for easy operation.

- (2) Power Level Pad (☛page 10)
- (3) Number Pads
- (4) Timer Pad (☛page 10)
- (5) More/Less Pad (☛page 12)
- (6) Quick Min Pad (☛page 9)
- (7) Sensor Reheat Pad (☛page 12)
- (8) Sensor Cook Pad (☛page 12)
- (9) Keep Warm Pad (☛page 9)
- (10) Serving/Weight Pad (☛page 9)
- (11) Clock Pad (☛page 9)
- (12) Function Pad (☛page 8)
- (13) Popcorn Pad (☛page 11)
- (14) Inverter Turbo Defrost Pad (☛page 11)
- (15) Start Pad

One tap allows oven to begin functioning. If door is opened or **Stop/Reset** Pad is pressed once during oven operation, **Start** Pad must be pressed again to restart oven.

(16) Stop/Reset Pad

Before cooking: One tap clears your instruction.
During cooking: One tap temporarily stops the cooking process. Another tap cancels all your instructions and time of day or colon appears on the **Display Window**.

Beep Sound:

When a pad is pressed correctly, a beep will be heard. If a pad is pressed and no beep is heard, the unit did not, or cannot, accept the instruction. The oven will beep twice between programmed stages. At the end of any complete program, the oven will beep 5 times.

To Use Function Pad

This unique feature of your PANASONIC microwave oven allows you to establish the initial non-cooking features of your oven such as CHILD LOCK, WORD SPEED, LANGUAGE CHOICE (ENGLISH, FRENCH OR SPANISH), plus many more. See below.

| | | |
|----|--|--|
| 1) |  | Press: FUNCTION. Menu Action Message is "Select Function 0 through 9, 1--LANGUAGE CHOICE --- etc". |
| 2) | Select a number (0-9) Ex. CHILD LOCK is 5 | Press 5: Menu Action Message is "CHILD LOCK ON/OFF". |
| 3) | Select <input type="text" value="1"/> , <input type="text" value="2"/> or <input type="text" value="3"/> | Press: One number. Your selection is now part of the operating system. You can change it any time. |
| 4) | Continue until you have completed your selections. | See below for other options. |



| | | |
|---|----------|--|
| → | 1 | <p>LANGUAGE CHOICE The oven has English, French and Spanish display. The display appears in English when you plug-in.</p> <p>1 ENGLISH → Display appears in English. 2 FRANCAIS → Display appears in French. 3 ESPANOL → Display appears in Spanish.</p> |
| → | 2 | <p>Lb/KG CHOICE The oven has both imperial and metric weight measurements. The oven displays the weight in imperial when you plug it in.</p> <p>1 Lb → Weight can be set in oz/lb, (Imperial). 2 KG → Weight can be set in g/kg, (Metric).</p> |
| → | 3 | <p>WORD SPEED The speed of word scrolling in the <i>Display Window</i> can be sped up or slowed down.</p> <p>1 QUICK → Words scroll quickly. 2 MEDIUM → Scrolling speed returns to initial setting. 3 SLOW → Words scroll slowly.</p> |
| → | 4 | <p>MENU ACTION ON/OFF MENU ACTION SCREEN helps you to program your oven by prompting the next step to be taken. When you become familiar with your oven, the prompting can be turned off.</p> <p>1 ON → Prompting Guide will appear. 2 OFF → Prompting Guide will not appear.</p> |
| → | 5 | <p>CHILD LOCK ON/OFF The oven has Child Safety Lock feature which prevents use by children. It does not lock the door.</p> <p>1 ON → Child Lock has been set and operation will not be accepted. 2 OFF → Child Lock has been cancelled.</p> |
| → | 6 | <p>BEEP ON/OFF If you wish to have the oven operate with no beep, it can be eliminated.</p> <p>1 ON → Beep sound will reactivate. 2 OFF → Beep sound will not be heard.</p> |
| → | 7 | <p>REMINDER BEEP ON/OFF A reminder beep works to remind you to remove the food from the oven after the completion of cooking. It will occur every 15 seconds.</p> <p>1 ON → Reminder beep will work. 2 OFF → Reminder beep will not work.</p> |
| → | 8 | <p>DAYLIGHT SAVING ON/OFF</p> <p>1 ON → Time of day will advance one hour. 2 OFF → Time of day returns to original setting.</p> |
| → | 9 | <p>CLOCK ON/OFF Clock display can be turned off.</p> <p>1 ON → Clock display will appear in the <i>Display Window</i>. 2 OFF → Clock display will not appear in the <i>Display Window</i>. Time of day will not be lost while the display is off.</p> |
| → | 0 | <p>DEMO MODE ON/OFF Demo mode is designed for retail store display. In this mode, the oven can be demonstrated with no power in the oven.</p> <p>1 ON → The oven is in Demo mode. 2 OFF → The oven is not in Demo mode.</p> |

Let's Start to Use Your Oven!

1. Plug into a properly grounded electrical outlet.



Display Window

"WELCOME TO PANASONIC -- REFER TO OPERATING INSTRUCTIONS BEFORE USE" scrolls across **Display Window**.



2. The messages in the **Display Window** automatically appear in English.

If you wish to use Spanish or French, use the **Function** pad language option.

If you wish to use metric measurements, use the **Function** pad weight option.

Display Window

3. At the end of the "WELCOME..." message, a colon appears in the **Display Window**.

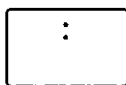

Now, enjoy cooking with your Panasonic microwave.

Quick Min

This feature allows you to set and/or add cooking times easily in multiples of one minute.

To Set Cooking Time:

Example: 5 minutes

1. **Quick Min** Press. (up to 10)

Set cooking time. Power level is P10 (HIGH).

Display Window

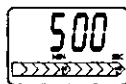

2. **Start** Press.

Cooking begins and time counts down. Power level arrow begins to scroll.



At the end of cooking, five beeps sound and "ENJOY YOUR MEAL" appears in the **Display Window**



NOTES:

1. To use with other power levels, Press **Power Level**, then **Quick Min**.
2. If you use **Quick Min**, you can not use the Number Pads or vice versa.
3. Press **Quick Min** to add more time during cooking. To verify the additional cooking time, check the **Display Window**.

Clock

This feature allows you to display the time of day. The oven will operate without setting the clock.

Example: To set 12:34 AM or PM.

1. **Clock** Colon appears and flashes.

Press.

"SET TIME" scrolls across **Display Window**.

Display Window

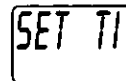
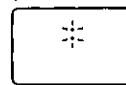

2. Enter time of day using number pads.

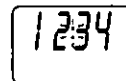

Colon continues flashing.

"PRESS CLOCK PAD" scrolls across **Display Window**.

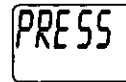

3. **Clock**

Press **Clock** again to set time of day.

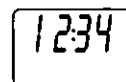

Colon stops flashing.

NOTES:

1. To reset the clock, repeat step 1 through 3.
2. The Clock will retain the time of day as long as electricity is supplied.
3. Clock is a 12 hour display.
4. Oven will not operate while colon is flashing.

Keep Warm Pad

This feature helps you to keep a certain selection of foods warm for 30 minutes after cooking. (Pie, Gravy, Stew, Casserole or Mashed Potatoes)

1. **Keep Warm** Press twice.

"GRAVY -- PRESS SERV/WEIGHT" appears in **Display Window**.

Display Window



2. **Serving Weight** Press twice.

Verify serving size (1-4) in **Display Window**.



3. **Start** Press.

Keep Warm time appears in **Display Window** and begins to count down from 30 minutes.



At the end of cooking, five beeps sound and "ENJOY YOUR MEAL" appears in the **Display Window**.





Manual Operation (Power & Time Setting)

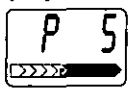

This feature allows you to manually set the power and time for microwave cooking.

Press **Power Level** pad until desired power appears in the **Display Window**. See Chart below.

Example: To cook at P5 for 1 minute 30 seconds.

1.  "P 5 SET TIME" appears in **Display Window**.
Press six times. 

2.  Enter cooking time using number pads. 

3.  **Display Window** counts down and power level arrow begins to scroll. 

At the end of cooking, five beeps sound and "ENJOY YOUR MEAL" appears in the **Display Window**



| Press Power Level | Power Level | Display Window |
|-------------------|-----------------|----------------|
| once | P10 (HIGH) | |
| twice | P 9 | |
| 3 times | P 8 | |
| 4 times | P 7 (MED. HIGH) | |
| 5 times | P 6 (MEDIUM) | |
| 6 times | P 5 | |
| 7 times | P 4 | |
| 8 times | P 3 (MED. LOW) | |
| 9 times | P 2 | |
| 10 times | P 1 (LOW) | |

NOTES:



- For more than one stage cooking, repeat steps 1 & 2 for each stage of cooking before pressing **Start** pad. Maximum number of stages for cooking is 5 stages.
- When selecting P10(HIGH) power for the first stage, you can begin at step 2.
- Two beeps will sound between each stage of programming. Five beeps will sound at the end of the entire sequence.
- When selecting P10(HIGH) power, the maximum time is 30 minutes. For other power levels the maximum time is 99 minutes and 99 seconds.
- For reheating, use P10(HIGH) for liquids, P 7(MEDIUM-HIGH) for most foods and P 6 (MEDIUM) for dense foods.
- For defrosting, use P 3(MEDIUM-LOW/DEF).

Timer

This feature allows you to:

- Use it as a Kitchen **TIMER**.
- Program **STAND** time after cooking is completed.
- Program **DELAY** time for beginning cooking.

To Set TIMER:

1.  "TIMER - - SET TIME" appears in the **Display Window**.
Press once. 

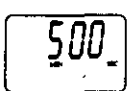
2.  Enter time using Number pads (up to 99 minutes and 99 seconds). 

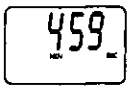
3.  **Timer** will count down. No cooking will occur.
Press once. 

To Activate TIMER Program:

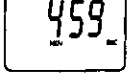
3.  **Timer** will count down. No cooking will occur.
Press once. 



At the end of cooking, five beeps sound and "ENJOY YOUR MEAL" appears in the **Display Window**



NOTES:

- When each stage finishes, a two beep signal sounds. At the end of the program, the oven will beep five times.
- If oven door is opened during the **TIMER/DELAY/STAND** time, the time in the **Display Window** will continue to count down.
- DELAY** time cannot be programmed before any Auto Control Feature. This is to prevent the starting temperature of the food from rising before defrosting or cooking begins. A change in the starting temperature would cause inaccurate cooking results.
- Timer can be set up to 99 minutes and 99 seconds.



To Set DELAY Time:

 →  → (Input up to 4-stage Cooking Program.) → 

Press once. Enter DELAY time using number pads. Press.

* Cooking will start after DELAY time has expired.

To Set STAND Time:

(Input up to 4-stage Cooking Program.) →  →  → 

Press once. Enter STAND time using number pads. Press.

* STAND time will count down after cooking occurs.



Popcorn Pad

For use with prepackaged Popcorn bags.



Example: To pop 3.5 oz. package of microwave popcorn.

Press **Popcorn** pad until package weight appears in the **Display Window**. See Chart below.

Display Window

-  "POPCORN (weight) - - PRESS START" scrolls across **Display Window**. 

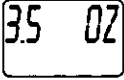
Press five times.

Verify packaged weight in **Display Window**. 
-  Cooking begins. 

Press.

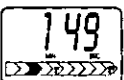
Time counts down and power level arrow scrolls. 

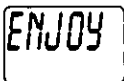
At the end of cooking, five beeps sound and "ENJOY YOUR MEAL" appears in the **Display Window** 

| Press Popcorn pad | Popcorn package | Time |
|-------------------|-----------------|-----------------|
| once | 1.75 oz (50 g) | will vary |
| twice | 2.65 oz (75 g) | depending |
| three times | 2.85 oz (80 g) | on size and |
| four times | 3.0 oz (90 g) | wattage of oven |
| five times | 3.5 oz (99 g) | |

NOTES:

- Popcorn packages should be at room temperature.
- Place bag in oven according to manufacturer's directions.
- Pop **one** bag at a time.
- After popping, allow bag to cool. Carefully open bag away from face and body, since popcorn and steam are extremely hot.
- NEVER** leave the oven unattended when popping popcorn.
- Do not reheat unpopped kernels or reuse bag.
- With the many varieties of microwave popcorn available in the market place, it may be necessary for you to move the popcorn container to the outer edge of the glass tray to obtain the best cooking results.

REMARKS: When popping multiple bags one right after the other, the cooking times may vary slightly. This does not affect the popping results.



CAUTION: If prepackaged popcorn is of a different weight than the recommended weight, do not use the preset popcorn settings. Set Power Level and Time according to the manufacturer's instructions.



Inverter Turbo Defrost

This feature allows you to defrost meat, poultry and seafood simply by entering the weight.

Example: To defrost 2.5 lbs (2 lbs 8 oz) of meat.

Display Window

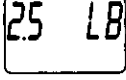
-  "INVERTER TURBO DEFROST - - SET WEIGHT" appears in **Display Window** 

Press.
-  Enter weight using number pads. (6.0 lb maximum) 
-  Defrost time* appears. 

Press.

Display Window counts down. 

At the end of cooking, five beeps sound and "ENJOY YOUR MEAL" appears in the **Display Window** 

***NOTE:** Time will vary depending on size and wattage of your oven.

Conversion Chart







Follow this chart to convert ounces or hundredths of a pound into tenths of a pound.

Example: If a piece of frozen meat weighs 1 pound 14 ounces, the equivalent is 1.9 pounds.

| Ounces | Hundredths of a Pound | Tenths of a Pound |
|---------|-----------------------|-------------------|
| 0 | .96 - .05 | 0.0 |
| 1 - 2 | .06 - .15 | 0.1 |
| 3 - 4 | .16 - .25 | 0.2 |
| 5 | .26 - .35 | 0.3 |
| 6 - 7 | .36 - .45 | 0.4 |
| 8 | .46 - .55 | 0.5 |
| 9 - 10 | .56 - .65 | 0.6 |
| 11 - 12 | .66 - .75 | 0.7 |
| 13 | .76 - .85 | 0.8 |
| 14 - 15 | .86 - .95 | 0.9 |

Sensor Cook

This sensor feature allows you to cook any quantity of food with only one touch. The oven does it all for you.

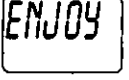
1.  Press. "BREAKFAST -- SELECT SERVING/WEIGHT" appears in *Display Window*. 
 2.  Optional*.
 3.  Press. Cooking starts. The word "SENSOR" appears in the *Display Window*. 
 4. After heat/steam is detected by the *Genius*, 2 beeps sound. 
The remaining cooking time appears in the *Display Window* and begins to count down. Power level arrow scrolls. 
- At the end of cooking, five beeps sound and "ENJOY YOUR MEAL" appears in the *Display Window*. 

*More/Less Pad

Preferences for food doneness vary with each individual. After having used the Sensor Cooking a few times, you may decide you would prefer your food cooked to a different doneness. By using the *More/Less* pad, the programs can be adjusted to cook food for a longer or shorter time.

- 1 tap=*More* cooking
- 2 taps=*Less* cooking
- 3 taps=original setting

Press *More/Less* before pressing *Start*.







For best Sensor cooking results, follow these recommendations.

BEFORE Reheating/Cooking

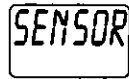
1. The room temperature surrounding the oven should be below 95° F (35° C).
2. Food weight should exceed 4 oz. (110 g).
3. Glass Tray and outside of container should be dry.
4. Cover food loosely but completely with plastic wrap, or place foods in a casserole dish with a proper fitting lid.
5. All foods should be taken from their normal storage place.

Sensor Reheat

This feature allows you to reheat any quantity of food with only one touch.

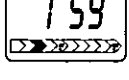
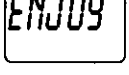
1.  Press. "SENSOR REHEAT -- PRESS START" appears in *Display Window*. 
 2.  Optional*.
 3.  Optional.
 4.  Press. Reheating starts. The word "SENSOR" appears in the *Display Window*. 
- After heat/steam is detected by the *Genius*, 2 beeps sound. 
The remaining cooking time appears in the *Display Window* and begins to count down. Power level arrow scrolls. 
- At the end of cooking, five beeps sound and "ENJOY YOUR MEAL" appears in the *Display Window*. 

NOTES:

Casseroles - Add 3 to 4 tablespoons of liquid; cover with lid or plastic wrap. Stir when time appears in the *Display Window*.

Canned foods - Empty contents into casserole dish or serving bowl; cover dish with lid or plastic wrap. After reheating, release plastic wrap and stand.

Plate of food - Arrange food on plate; top with butter, gravy, etc.. After reheating, release plastic wrap and stand.

Follow the recommendations for Sensor Cooking, in addition to the following:

DO NOT:

1. Reheat bread and pastry products. Use manual power and time for these foods.
2. Reheat raw or uncooked food.
3. Use if oven cavity is warm.
4. Use for beverages.
5. Use for frozen foods.

DURING Reheating/Cooking:

DO NOT open the oven door until 2 beeps sound and time appears in the *Display Window*. Doing so will cause inaccurate cooking since the steam from food is no longer contained within the oven cavity. Once the timer begins to count down, the oven door may be opened to stir, turn, shield, rearrange, mix or add foods.

AFTER Reheating/Cooking:

All foods should have a covered stand time.

Defrosting Tips & Techniques

Before Freezing:

1. Freeze meats, poultry and fish in packages with only 1 or 2 layers of food.
Place wax paper between layers.
2. Package in heavy-duty plastic wraps, bags (labeled "For Freezer") or freezer paper.
3. Remove as much air as possible, i.e. create a vacuum.
4. Seal securely, date and label.

To Defrost:

1. Remove wrapper. This helps moisture to evaporate.
Juices from food can get hot and cook the food.
2. Set food on microwave safe roasting rack in an appropriately sized dish.
3. Place roasts fat-side down. Place whole poultry breast-side down.
4. Drain liquids during defrosting.
5. Turn over (invert) items during defrosting.
6. Shield edges and ends if needed. (See **Cooking Techniques**).
7. Select power and minimum time so that items will be under-defrosted.

After Defrosting:

1. Large items may be icy in the center. Defrosting will complete during **STANDING TIME**.
2. Let stand, covered with plastic wrap, in the refrigerator for time shown in the chart below.
3. See chart below for standing time and rinsing directions.
4. Items which have been layered should be rinsed separately or have a longer stand time.

| FOOD | DEFROST TIME (min. per pound) (P 3) | DURING DEFROSTING | AFTER DEFROSTING | |
|--|---|---|--------------------|-----------------------|
| | | | Stand Time | Rinse (cold water) |
| Fish and Seafood [up to 3 lbs. (1.4 kg)] | | | | |
| Crabmeat | 6 | Break apart/Rearrange | 5 min. | YES |
| Fish Steaks | 4 to 6 | Turn over | | |
| Fish Fillets | 4 to 6 | Turn over/Rearrange/Shield ends | | |
| Sea Scallops | 4 to 6 | Break apart/Remove defrosted pieces | | |
| Whole fish | 4 to 6 | Turn over | | |
| Meat | | | | |
| Ground Meat | 4 to 5 | Turn over/Remove defrosted portion/Shield edges | 10 min. | NO |
| Roasts [2½ - 4 lbs. (1.1-1.8 kg)] | 4 to 8 | Turn over/Shield ends and defrosted surface | 30 min. in refrig | |
| Chops/Steak | 6 to 8 | Turn over/Rearrange/Shield ends and defrosted surface | 5 min. | |
| Ribs/T-bone | 6 to 8 | Turn over/Rearrange/Shield ends and defrosted surface | | |
| Stew Meat | 4 to 8 | Break apart/Rearrange/Remove defrosted pieces | | |
| Liver (thin sliced) | 4 to 6 | Drain liquid/Turn over/Separate pieces | | |
| Bacon (sliced) | 4 | Turn over | | |
| Poultry | | | | |
| Chicken, Whole [up to 3 lbs. (1.4 kg)] | 4 to 6 | Turn over/Shield | 20 min. in refrig. | YES |
| Cutlets | 4 to 6 | Break apart/Turn over/Remove defrosted pieces | 5 min. | |
| Pieces | 4 to 6 | Break apart/Turn over/Shield | 10 min. | |
| Cornish Hens | 6 to 8 | Turn over/Shield | | |
| Turkey Breast [5 - 6 lbs. (2.3 - 2.7 kg)] | 6 | Turn over/Shield | 20 min. in refrig | |

Microwave Shortcuts

| FOOD | POWER SETTING | TIME (in minutes) | DIRECTIONS |
|---|---|-----------------------------------|---|
| To separate Bacon , 1 pound (450 g) | P10 (HIGH) | 30 sec. | Remove wrapper and place in a microwave safe dish. After heating, use a plastic spatula to separate slices. |
| To soften Brown Sugar 1 cup (250 mL) | P10 (HIGH) | 20 - 30 sec. | Place brown sugar in microwave safe dish with a slice of bread. Cover with plastic wrap. |
| To melt Butter , 1 stick, ¼ pound (110 g) | P 6 (MEDIUM) | 1½ - 2 | Remove wrapper and place butter in a microwave safe dish covered with plastic wrap. |
| To soften Butter , 1 stick ¼ pound (110 g) | P 3 (MEDIUM-LOW) | 1 | Remove wrapper and place butter in a microwave safe dish. |
| To melt Chocolate , 1 square, 1 oz. (28 g) | P10 (HIGH) | 1 - 1½ | Remove wrapper and place chocolate in a microwave safe dish. Stir before adding more time. (Stir until completely melted.) <i>Note: Chocolate holds its shape even when softened.</i> |
| To melt Chocolate , ½ cup (125 mL) chips | P10 (HIGH) | 1 - 1½ | |
| To toast Coconut , ½ cup (125 mL) | P10 (HIGH) | 1 | Place in a microwave safe dish. Stir every 30 seconds. |
| To soften Cream Cheese , 8 oz. (250 g) | P 3 (MEDIUM-LOW) | 1 - 2 | Remove wrapper and place in a microwave safe bowl. |
| To brown Ground Beef , 1 pound (450 g) | P10 (HIGH) | 4 - 5 | Crumble into a microwave safe colander set into another dish. Stir twice. Drain grease. |
| To steam Hand Towels - 4 | P10 (HIGH) | 20 - 30 sec. | Soak in water, then wring out excess. Place on a microwave safe dish. Heat. Present immediately. |
| To soften Ice Cream , ½ gallon (2 qt.) | P 3 (MEDIUM-LOW) | 1 - 1½ | Check often to prevent melting. |
| Cup of liquid boiling water, broth, etc. 1 cup, 8 oz. (250 mL) 2 cups, 16 oz. (500 mL) to heat milk 1 cup, 8 oz. (250 mL) 2 cups, 16 oz. (500 mL) | P10 (HIGH) P 7 (MEDIUM-HIGH) | 2½ - 3 4 2 - 3 4 - 5 | Heated liquids can erupt if not stirred. Do not heat liquids in your microwave oven without stirring before and after heating. |
| To roast Nuts , 1½ cups (375 mL) | P10 (HIGH) | 4 - 5 | Spread nuts into a 9-inch (230 mm) microwave safe pie plate. Stir occasionally. |
| To toast Sesame Seeds , ¼ cup (50 mL) | P10 (HIGH) | 3 - 5 | Place in a small microwave safe bowl. Stir twice. |
| To skin Tomatoes (one at a time) | P10 (HIGH) | 30 sec. | Place tomato into a microwave safe bowl containing boiling water. Rinse and peel. Repeat for each tomato. |
| To remove Cooking Odors | P10 (HIGH) | 5 | Combine 1 to 1½ cups (250 - 375 mL) water with the juice and peel of one lemon in a small microwave safe bowl. After heating, wipe interior of oven with damp cloth. |

Sensor Cook Chart

Ⓛ Indicates 2 Level Cooking

| Pad | Recipe | Serving/Weight | HINTS |
|--------------------|---|-----------------------------|---|
| Breakfast | 1. Breakfast Sausage Ⓛ Oatmeal | 4 each / ½ cup | Follow manufacturers' directions for preparation of pre-cooked breakfast sausage. Arrange sausage in a radial pattern. Place on top of 2 Level Cooking Rack. Oatmeal place inside microwave-safe serving bowl with no cover. Follow manufacturers' directions for preparation of quick oatmeal. Place on top of Glass Tray. |
| | 2. Omelet/Bacon Ⓛ | 2 eggs / 2 slices | Follow Basic Omelet recipe for 2 eggs on Page 17. Place on top of 2 Level Cooking Rack. Place bacon on microwave-safe dish covered with paper towel. Place on top of Glass Tray. Dishes should be shifted in the oven to ensure even cooking. Times may vary by brand (weight). |
| | 3. Bacon/Oatmeal Ⓛ | 2 slices / ½ cup | Place oatmeal inside a microwave-safe serving bowl with no cover. Follow manufacturers' directions for preparation of quick oatmeal. Place on top of 2 Level Cooking Rack. Place bacon on microwave-safe dish covered with paper towel. Place on top of Glass Tray. Dishes should be shifted in the oven to ensure even cooking. Times may vary by brand (weight). |
| | 4. Breakfast Sausage | 8 maximum | Follow manufacturers' directions for preparation of pre-cooked breakfast sausage. Place in a radial pattern. For 2 Level Cooking, dishes should be shifted in the oven to ensure even cooking. |
| | 5. Breakfast Sausage Ⓛ | 8 X 2 maximum | |
| | 6. Oatmeal | ½ cup, 1 cup | Place inside microwave-safe serving bowl with no cover. Follow manufacturers' directions for preparation of quick oatmeal. |
| Lunch/Snack | 1. Frozen Entrées/ Soup Ⓛ | 8 oz. / 1 cup | Place 1 cup of soup in a microwave-safe serving bowl. Cover loosely with vented plastic wrap. Place on top of 2 Level Cooking Rack. For Frozen Entrées, follow manufacturers' directions for covering or removing covers. Place on top of Glass Tray. Dishes should be shifted in the oven to ensure even cooking. |
| | 2. Hot Dog | 1-4 | Make 3 slits on each hot dog. Place hot dog on paper plate or microwave-safe dish leaving space between each. Times may vary by size and manufacturer. |
| | 3. Frozen Pizza | 4, 8 oz. | Follow manufacturers' directions for preparation. |
| | 4. Frozen Pizza Ⓛ | 4, 8 oz. | For 2 Level Cooking, dishes should be shifted in the oven to ensure even cooking. |
| | 5. Frozen Entrées | 8, 10, 20, 32 oz. | Follow manufacturer's directions for preparation of 8 and 10 oz. sizes. For larger entrées, where the directions state for the entire film cover to be removed, do not vent or remove film cover to ensure the sensor will detect accurately for complete cooking. Be careful when removing the film cover after cooking. Remove them away from you to avoid steam burns. For 2 Level Cooking, dishes should be shifted in the oven to ensure even cooking. |
| | 6. Frozen Entrées Ⓛ | 8, 10, 20, 32 oz. | |
| Side Dish | 1. Potatoes | 4 maximum (6-8 oz. each) | Pierce at least 6 times on top of the potato with a fork. Place potatoes on a microwave-safe dish. |
| | 2. Potatoes Ⓛ | 4 X 2 maximum | Do not cover. Let stand 5 minutes to complete cooking. |
| | 3. Fresh Vegetables | ¼ - 1 lb. | All pieces should be the same size. Add a small amount of water and cover loosely with lid or vented plastic wrap. |
| | 4. Fresh Vegetables Ⓛ | ¼ - 1 lb. | |
| | 5. Canned Vegetables | 15 oz. can size | Empty contents into microwave-safe serving bowl. Cover loosely with lid or vented plastic wrap. |
| | 6. Canned Vegetables Ⓛ | 15 oz. can size | |
| | 7. Frozen Vegetables | 6-16 oz. | Follow manufacturers' directions. Do not salt until after cooking. (Not suitable for vegetables in butter or sauce. After 2 beeps, stir or rearrange. |
| | 8. Frozen Vegetables Ⓛ | 6-16 oz. | |
| | 9. White Rice | ½ - 1 ½ cups | Place rice with hot water in a microwave-safe casserole dish. |
| | 10. Brown Rice | ½ - 1 ½ cups | Cover loosely with lid or vented plastic wrap. Let stand 5 to 10 minutes before serving. |

Sensor Cook Chart

Ⓛ Indicates 2 Level Cooking

| Pad | Recipe | HINTS |
|--------|---|--|
| Dinner | 1. <i>Curried Chicken/ White Rice</i> Ⓛ | Prepare according to recipes found on page 17. Place Curried Chicken on top of 2 Level Cooking Rack. Place White Rice in microwave-safe casserole dish. Place on top of Glass tray. After 2 beeps, stir chicken. Re-cover and press Start . Let both dishes stand 10 minutes before serving. Dishes should be shifted in the oven to ensure even cooking. |
| | 2. <i>Rotini with Pesto/ French Green Beans and Mushrooms</i> Ⓛ | Prepare according to recipes found on page 17. Place Green Beans on top of 2 Level Cooking Rack. Place Rotini on top of Glass Tray. After cooking, stir Pesto Sauce into drained noodles. |
| | 3. <i>Salmon Fillets with Dill/ Frozen Vegetables</i> Ⓛ | Prepare according to recipes found on page 18. Place Salmon Fillets on top of 2 Level Cooking Rack. Place Frozen Vegetables in a microwave-safe serving bowl on top of Glass Tray. Let both dishes stand 5 minutes before serving. Dishes should be shifted in the oven to ensure even cooking. |
| | 4. <i>Gingered Chicken/ Parsley-Mushroom Rice</i> Ⓛ | Prepare according to recipes found on page 18. Place Parsley Mushroom Rice on top of 2 Level Cooking Rack. Place Gingered Chicken on top of Glass Tray. Let both dishes stand 10 minutes before serving. Dishes should be shifted in the oven to ensure even cooking. |
| | 5. <i>Stuffed Meat Loaf</i> | Prepare according to recipe found on page 18. Let stand 5 minutes before serving. |
| | 6. <i>Stuffed Meat Loaf</i> Ⓛ | For 2 Level Cooking, dishes should be shifted in the oven to ensure even cooking. (Note: The dish placed on top of the 2 Level Cooking Rack should be covered with vented plastic wrap. The dish placed on top of the Glass Tray should be covered with vented aluminum foil.) |
| | 7. <i>Chicken Parmigiana</i> | Prepare according to recipe found on page 19. After 2 beeps, turn chicken and add toppings. Re-cover and press Start . Let stand 5 minutes before serving. |
| | 8. <i>Chicken Parmigiana</i> Ⓛ | For 2 Level Cooking, dishes should be shifted in the oven to ensure even cooking. |
| | 9. <i>Stuffed Pork Chops</i> | Prepare according to recipe found on page 19. Let stand 5 minutes before serving. |
| | 10. <i>Stuffed Pork Chops</i> Ⓛ | |
| | 11. <i>Shrimp Creole</i> | Prepare according to recipe found on page 19. After 2 beeps, stir. Re-cover and press Start . Let stand 5 minutes before serving. |
| | 12. <i>Shrimp Creole</i> Ⓛ | |
| | 13. <i>Vegetable Medley</i> | Prepare according to recipe found on page 19. After 2 beeps, stir. Re-cover and press Start . Let stand 5 minutes before serving. |
| | 14. <i>Vegetable Medley</i> Ⓛ | For 2 Level Cooking, dishes should be shifted in the oven to ensure even cooking. |

Sensor Cook Numbers and Recipes

- Breakfast**
- 1 Ⓛ Breakfast Sausage/Oatmeal
 - 2 Ⓛ Omelet/Bacon
 - 3 Ⓛ Bacon/Oatmeal
 - 4 Breakfast Sausage
 - 5 Ⓛ Breakfast Sausage
 - 6 Oatmeal

- Lunch/Smooth**
- 1 Ⓛ Frozen Entrées/Soup
 - 2 Hot Dog
 - 3 Frozen Pizza
 - 4 Ⓛ Frozen Pizza
 - 5 Frozen Entrées
 - 6 Ⓛ Frozen Entrées

- Side Dish**
- 1 Potatoes
 - 2 Ⓛ Potatoes
 - 3 Fresh Vegetables
 - 4 Ⓛ Fresh Vegetables
 - 5 Canned Vegetables
 - 6 Ⓛ Canned Vegetables
 - 7 Frozen Vegetables
 - 8 Ⓛ Frozen Vegetables
 - 9 White Rice
 - 10 Brown Rice

- *See Instruction Manual for Sensor Cook Recipes**
- Dinner**
- 1 Ⓛ Curried Chicken/White Rice
 - 2 Ⓛ Rotini with Pesto/French Green Beans and Mushrooms
 - 3 Ⓛ Salmon Fillets with Dill/Frozen Vegetables
 - 4 Ⓛ Gingered Chicken/Parsley-Mushroom Rice
 - 5 Stuffed Meat Loaf
 - 6 Ⓛ Stuffed Meat Loaf
 - 7 Chicken Parmigiana
 - 8 Ⓛ Chicken Parmigiana
 - 9 Stuffed Pork Chops
 - 10 Ⓛ Stuffed Pork Chops
 - 11 Shrimp Creole
 - 12 Ⓛ Shrimp Creole
 - 13 Vegetable Medley
 - 14 Ⓛ Vegetable Medley
- Ⓛ Indicates 2 Level Cooking Rack

CAUTION: 2 Level Cooking Rack may become HOT during cooking. Use caution when handling 2 Level Cooking Rack

2 Level Cooking Rack

COOKING POSITION:

Open LEGS completely and push until they lock into place.

SAFETY PRECAUTIONS:

1. To avoid tipping, ensure that the LEGS are securely locked.
2. Use covered dishes and place in the center of the rack to prevent tilting and spillage of food.
3. Not for use with a Browning Dish or popcorn bags.
4. Use for recommended recipes only.

STORAGE POSITION:

To release LEGS from locking tabs, push locking tabs outward and fold legs upward until they snap into place.

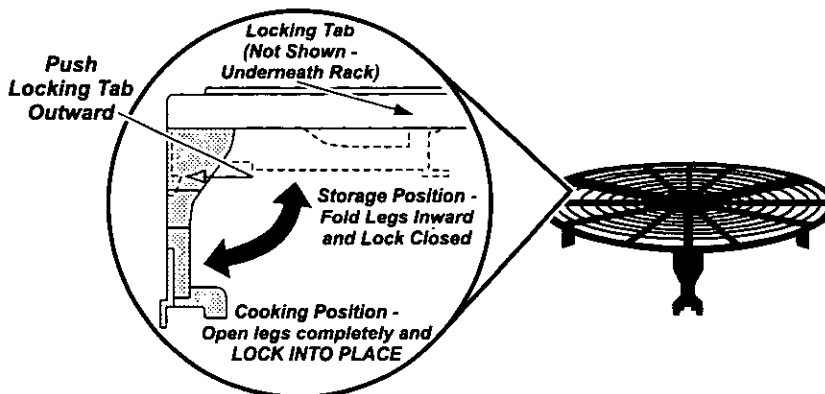

Sensor Cook Recipes

BREAKFAST

Basic Omelet

(Approx. cooking time: 4 minutes)

- 1 tablespoon butter or margarine
- 2 eggs
- 2 tablespoons milk
- Salt and ground black pepper, if desired

Heat butter in a 9-inch pie plate, 30 seconds at P10, or until melted, turn the plate to coat the bottom with butter. Meanwhile, combine the remaining ingredients; pour into the pie plate. Cook, covered with vented aluminum foil, on OMELET. Let stand 2 minutes. With a spatula, loosen the edges of the omelet from the plate; fold into thirds to serve.

Yield: 1 serving

NOTE: Double ingredients for a 4 egg omelet

DINNER

1. Curried Chicken/White Rice

White Rice

(Approx. cooking time: 23 minutes)

Curried Chicken

- 3 tablespoons all-purpose flour
- 1 tablespoon curry powder
- 1/2 teaspoon ground ginger
- 1/2 teaspoon salt
- 1 pound boneless, skinless chicken breasts, cut into 1-inch cubes
- 1 small chopped onion
- 2-3 tablespoons lemon juice
- 1/4 cup butter or margarine
- 1 teaspoon instant chicken bouillon

Combine together flour, lemon juice, curry, ginger and salt in a small bowl. Set aside. In a 2-Qt. casserole, place cut up chicken combined with onion and lemon juice. Stir in flour mixture until well combined. Add in butter and bouillon.

Cover and place on 2 Level Cooking Rack.

Cook on **DINNER #1 (Curried Chicken/White Rice)**. When the oven beeps, stir chicken. Re-cover, and press **Start**.

Let stand 10 minutes. Serve chicken on top of rice.

Yield: 4 servings

White Rice on Bottom

- 1 1/2 cups uncooked long grain rice
- 3 cups hot water

Place both ingredients in 3-Qt. casserole.

Cover and place on Glass Tray. Cook on **DINNER #1**

(**Curried Chicken/White Rice**). Let stand 5 minutes before serving.

Yield: 4 servings

NOTE: Dishes should be shifted in the oven to ensure even cooking.

2. Rotini with Pesto/French Green Beans and Mushrooms

(Approx. cooking time: 12 minutes)

French Green Beans and Mushrooms on Top

- 1 package (9 oz.) frozen French style green beans
- 1 can (4 oz.) mushroom pieces and stems, drained (reserve 1 tablespoon liquid)
- 1 tablespoon butter or margarine
- 1/2 teaspoon salt

Place all ingredients in a 1 1/2 Qt. casserole. Cover and place on 2 Level Cooking Rack. Cook on **DINNER #2 (Rotini with Pesto/French Green Beans and Mushrooms)**.

Yield: 4 servings

Rotini with Pesto Sauce on bottom

- 8 ounces uncooked Rotini Noodles
- 8 cups water

In a 3-Qt. casserole, mix together Rotini Noodles with water. Cover and place on Glass Tray. Cook on **DINNER #2 (Rotini with Pesto/French Green Beans and Mushrooms)**.

At the end of cooking, drain noodles and place back into casserole dish.

- 1/2 cup grated Parmesan cheese
- 3 tablespoons dried basil leaves
- 2 tablespoons pine nuts, finely chopped
- 1 clove minced garlic
- 1/2 cup olive oil
- 1/4 teaspoon salt, optional

Combine all ingredients except olive oil in food processor. Mix together while pouring a constant stream of oil through the opening, until well combined. Stir Pesto sauce into drained noodles.

Yield: 4 servings

How to shift dishes:

e. g. LUNCH/SNACK # 4 (Frozen Pizza)

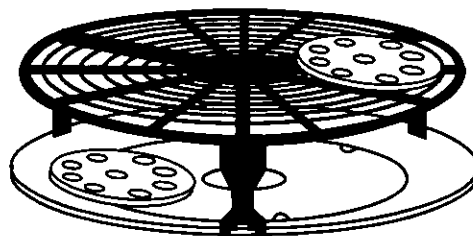

Sensor Cook Recipes

3. Salmon Fillets with Dill/Frozen Vegetables

(Approx. cooking time: 19 minutes)

Salmon Fillets with Dill on Top

- 1/2 cup thinly sliced celery
- 1/4 cup butter or margarine
- 1/4 cup white wine
- 3 tablespoons lemon juice
- 1 teaspoon dill weed
- 1/4 teaspoon salt
- 1/4 teaspoon ground black pepper
- 4 salmon fillets 1-inch thick (about 6 oz. each)

In a 1-Qt. casserole dish, combine together all ingredients except salmon fillets. Cook, covered, on P10 for 5 minutes. Dip each salmon fillet in butter sauce and arrange inside 2.5 Qt. oval casserole dish; with thickest portion toward edge of dish. Spoon remaining sauce over each fillet. Cover and place on 2 Level Cooking Rack. Cook on **DINNER #3 (Salmon Fillets with Dill/Frozen Vegetables)**. At the end of cooking, let stand, covered, 5 minutes before serving. Cover and place on 2 Level Cooking Rack. Cook on **DINNER #3 (Salmon Fillets with Dill/Frozen Vegetables)**. Let stand 5 minutes before serving.

Yield: 4 servings

Frozen Vegetables on bottom

- 1 package (16 oz.) frozen vegetables
- 2 tablespoons water

In a 9-inch round cake dish, combine frozen vegetables and water. Cover and place on Glass Tray. Cook on **DINNER #3 (Salmon Fillets with Dill/Frozen Vegetables)**. Let stand 5 minutes before serving.

Yield: 4 servings

4. Gingered Chicken/Parsley-Mushroom Rice

(Approx. cooking time: 27minutes)

Parsley-Mushroom Rice on top

- 3 cups hot water
- 1 1/2 cups uncooked long grain rice
- 1/2 cup finely chopped green onion
- 1/4 cup butter or margarine
- 3 tablespoons dried parsley flakes
- 1 tablespoon instant chicken bouillon
- 1 teaspoon dried basil leaves
- 1 can (4 oz.) mushroom pieces and stems, drained
- 2 small cloves garlic, finely chopped
- Grated Parmesan cheese (if desired)

Combine all ingredients in 2-Qt. casserole. Cover and place on 2 Level Cooking Rack. Cook on **DINNER #4 (Gingered Chicken/Parsley Mushroom Rice)**. Let stand 5 minutes before serving.

Yield: 6 servings

Gingered Chicken on bottom

- 2 pounds chicken drumsticks, skinned
- 1/3 cup honey
- 1/3 cup chili sauce
- 1/3 cup soy sauce
- 1 teaspoon ground sugar
- 1/2 teaspoon salt
- 1/4 teaspoon ground black pepper
- 1 tablespoon cornstarch
- 2 tablespoons cold water

Arrange chicken pieces with thickest parts toward the outside edge of 2.5-Qt. oval casserole dish. Mix remaining ingredients except cornstarch and water; pour over chicken. Cover and place on Glass Tray. Cook on **DINNER#4 (Gingered Chicken/Parsley-Mushroom Rice)**. At the end of cooking, remove chicken to serving platter; keep warm. Mix cornstarch and water; stir into sauce. Microwave, covered, on P10 for 2 minutes. Stir every minute until thickened. Pour sauce over chicken.

Yield: 6 servings

NOTE: Dishes should be shifted in the oven to ensure even cooking.

5,6. Stuffed Meat Loaf

- 1 1/2 pounds lean ground beef
- 1 can (15 oz.) tomato sauce, divided
- 1 egg
- 1/3 cup seasoned dry bread crumbs
- 1/4 cup chopped green onions
- 2 cups finely chopped celery
- 1/4 teaspoon ground black pepper
- 1 cup (4 oz.) shredded mozzarella cheese
- 2 thin slices boiled ham
- 2 chopped stuffed green olives

In medium bowl, combine ground beef, 1 cup tomato sauce, egg, bread crumbs, onion, celery and pepper; mix well. In 9 x 5-inch loaf pan, shape half of meat mixture into bottom of pan. Top with cheese, ham and olives. Spread remaining meat mixture on top and pour remaining sauce over loaf.

TO COOK BY DINNER-5:

(Approx. cooking time: 25 minutes)

Cook, covered, on **DINNER #5 (Stuffed Meat Loaf)**. Let stand, 5 minutes, before serving.

TO COOK BY DINNER-6 - 2 LEVEL:

(Approx. cooking time: 55 minutes)

Follow instructions above. Prepare two individual recipes. Using the **2 Level Cooking Rack**, place one dish on the Glass Tray and the other on top of the **Rack**. Let stand, 5 minutes, before serving.

Yield: 6 servings

NOTE:

- 1) Dishes should be shifted in the oven to ensure even cooking.
- 2) The dish placed on the 2 Level Cooking Rack should be covered with vented plastic wrap. The dish placed on top of the Glass Tray should be covered with foil.

Sensor Cook Recipes

7,8. Chicken Parmigiana

- 1 egg
- 1/4 cup water
- 2 tablespoons vegetable oil, divided
- 1 cup seasoned dry bread crumbs
- 1/2 cup grated Parmesan cheese
- 1/4 teaspoon paprika
- 2 boneless skinless chicken breasts, halved (about 1 pound)
- 1 can (8 oz.) tomato sauce or 1 cup spaghetti sauce
- 1 cup (4 oz.) shredded mozzarella cheese
- Oregano leaves

Beat egg with water. In a separate bowl, combine bread crumbs, Parmesan cheese and paprika. Dip chicken in bread crumb mixture, then in egg mixture and again in bread crumb mixture. Coat bottom of 8-inch square baking dish with 1 tablespoon oil. Place coated chicken in dish; sprinkle with remaining oil.

To Cook by DINNER-7

(Approx. cooking time: 12 minutes)

Cook, covered, on **DINNER #7 (Chicken Parmigiana)**.

When the oven beeps, turn chicken and top with tomato sauce, oregano and cheese. Re-cover and press **Start**. Let stand 5 minutes before serving.

To Cook by DINNER-8 - 2 Level:

(Approx. cooking time: 22 minutes)

Follow instructions above. Prepare two individual recipes. Using the **2 Level Cooking Rack**, place one dish on the Glass Tray and the other on top of the **Rack**.

Yield: 4 servings

NOTE: Dishes should be shifted in the oven to ensure even cooking.

9, 10. Stuffed Pork Chops

- 1/4 cup thinly sliced celery
- 1/4 cup thinly sliced onion
- 2 tablespoons butter or margarine
- 1 1/2 cups seasoned croutons
- 1/4 cup water
- 4 thin rib pork chops, 1/4 - 1/2-inch thick
- Browning sauce
- Ground black pepper

In a small bowl, combine celery, onion and butter. Cook, covered, on P10 for 3 to 4 minutes, or until vegetables are tender. Add croutons and water; stir until absorbed. Place crouton mixture in the middle of each chop, fold over edges and secure with wooden toothpicks. Place chops, open-side up, in an 11 x 7-inch rectangular baking dish. Brush chops with browning sauce, season with pepper.

To Cook by Dinner-9:

(Approx. cooking time: 11 minutes)

Cook, covered, on **DINNER #9 (Stuffed Pork Chops)**. Let stand 5 minutes before serving.

To Cook by Dinner 10 - 2 Level:

(Approx. cooking time: 22 minutes)

Follow instructions above. Prepare two individual recipes. Using the **2 Level Cooking Rack**, place one dish on the Glass Tray and the other on top of the **Rack**. Follow instructions above.

Yield: 4 servings per recipe

11,12. Shrimp Creole

- 1/2 cup each finely chopped celery, green bell pepper and onion
- 1 pound medium shrimp, shelled and deveined
- 1 can (15 oz.) tomato sauce
- 2 cloves minced garlic
- 1 teaspoon salt
- 1 teaspoon hot pepper sauce
- 1/4 teaspoon ground black pepper

To Cook by DINNER-11

(Approx. cooking time: 8 minutes)

In a 2-Qt. casserole, combine all ingredients. Cook, covered, on **DINNER #11 (Shrimp Creole)**. When the oven beeps, stir. Re-cover and press **Start**. Let stand 5 minutes before serving.

To Cook by DINNER-12 - 2 Level:

(Approx. cooking time: 23 minutes)

Follow instructions above. Prepare two individual recipes.

Using the **2 Level Cooking Rack**, place one dish on the Glass Tray and the other on top of the **Rack**.

Yield: 4 servings

13, 14. Vegetable Medley

- 4 medium zucchini (about 6 oz. each), sliced 1/4-inch thick
- 4 stalks celery finely chopped
- 2 medium onions, sliced, separated into rings
- 1 can (15 oz.) tomato sauce
- 1 cup chopped green bell pepper
- 1/2 teaspoon salt
- 1/4 teaspoon garlic powder
- 1/4 teaspoon oregano
- 1/4 teaspoon ground black pepper
- 1/4 cup grated Parmesan cheese

In a 3-Qt. casserole dish, combine all ingredients except Parmesan cheese; mix well.

To Cook by DINNER-13

(Approx. cooking time: 33 minutes)

Cook, covered, on **DINNER #13 (Vegetable Medley)**.

When the oven beeps, stir. Recover and press **Start**. Let stand 5 minutes. Top with cheese before serving.

To Cook by DINNER-14 -2 Level

(Approx. cooking time: 1 hour)

Follow instructions above. Prepare two individual recipes.

Using the **2 Level Cooking Rack**, place one dish on the Glass Tray and the other on top of the **Rack**.

Yield: 4 servings per recipe

Note: Dishes should be shifted in the oven to ensure even cooking.

Food Characteristics

Bone and Fat

Both bone and fat affect cooking. Bones may cause irregular cooking. Meat next to the tips of bones may overcook while meat positioned under a large bone, such as a ham bone, may be undercooked. Large amounts of fat absorb microwave energy and the meat next to these areas may overcook.

Density

Porous, airy foods such as breads, cakes or rolls take less time to cook than heavy, dense foods such as potatoes and roasts. When reheating donuts or other foods with different centers be very careful. Certain foods have centers made with sugar, water or fat and these centers attract microwaves (For ex., jelly donuts). When a jelly donut is heated, the jelly can become extremely hot while the exterior remains warm to the touch. This could result in a burn if the food is not allowed to cool properly in the center.

Quantity

Two potatoes take longer to cook than one potato. As the quantity of the food increases so does the cooking time. When cooking small amounts of food such as one or two potatoes, do not leave oven unattended. The moisture content in the food may decrease and a fire could result.

Shape

Uniform sizes heat more evenly. The thin end of a drumstick will cook more quickly than the meaty end. To compensate for irregular shapes, place thin parts toward the center of the dish and thick pieces toward the edge.

Size

Thin pieces cook more quickly than thick pieces.

Starting Temperature

Foods that are room temperature take less time to cook than if they are chilled or refrigerated or frozen.

Cooking Techniques

Piercing

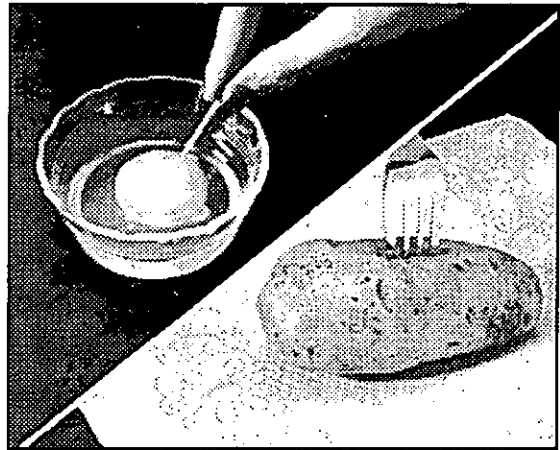

Foods with skins or membranes must be pierced, scored or have a strip of skin peeled before cooking to allow steam to escape. Pierce whole egg yolks and whites, clams, oysters, chicken livers, whole potatoes and whole vegetables. Whole apples or new potatoes should have a 1-inch strip of skin peeled before cooking. Score sausages and frankfurters.

Browning



Foods will not have the same brown appearance as conventionally cooked foods or these foods which are cooked utilizing a browning feature. Meats and poultry may be coated with browning sauce, Worcestershire sauce, barbecue sauce or shake-on browning sauce. To use, combine browning sauce with melted butter or margarine; brush on before cooking.

For quick breads or muffins, brown sugar can be used in the recipe in place of granulated sugar, or the surface can be sprinkled with dark spices before baking.

Cooking Techniques

Spacing

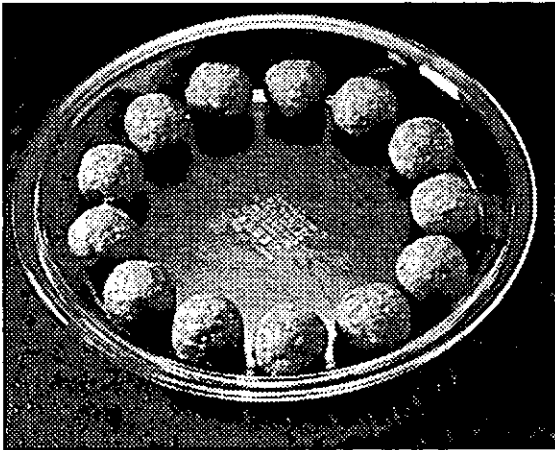

Individual foods, such as baked potatoes, cupcakes and appetizers, will cook more evenly if placed in the oven equal distances apart. When possible, arrange foods in a circular pattern.

Covering

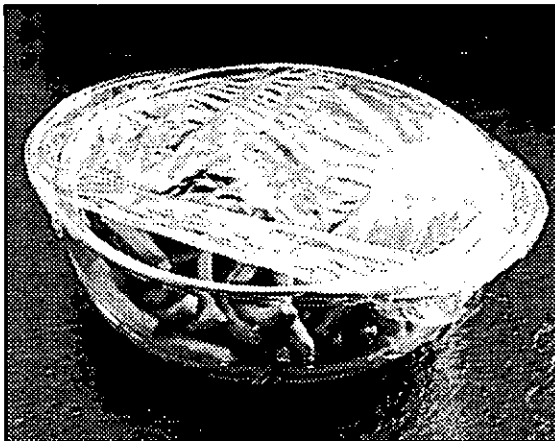

As with conventional cooking, moisture evaporates during microwave cooking. Casserole lids or plastic wrap are used for a tighter seal. When using plastic wrap, vent the plastic wrap by folding back part of the plastic wrap from the edge of the dish to allow steam to escape. Loosen or remove plastic wrap as recipe directs for stand time. When removing plastic wrap covers, as well as any glass lids, be careful to remove them away from you to avoid steam burns. Various degrees of moisture retention are also obtained by using wax paper or paper towels. However, unless specified, a recipe is cooked covered.

Shielding

Thin areas of meat and poultry cook more quickly than meaty portions. To prevent overcooking, these thin areas can be shielded with strips of aluminum foil. Wooden toothpicks may be used to hold the foil in place.

Timing

A range in cooking time is given in each recipe. The time range compensates for the uncontrollable differences in food shapes, starting temperature and regional preferences. Always cook food for the minimum cooking time given in a recipe and check for doneness. If the food is undercooked, continue cooking. It is easier to add time to an undercooked product. Once the food is overcooked, nothing can be done.

Stirring

Stirring is usually necessary during microwave cooking. We have noted when stirring is helpful, using the words once, twice, frequently or occasionally to describe the amount of stirring necessary. Always bring the cooked outside edges toward the center and the less cooked center portions toward the outside of the dish.

Rearranging

Rearrange small items such as chicken pieces, shrimp, hamburger patties or pork chops. Rearrange pieces from the edge to the center and pieces from the center to the edge of the dish.

Turning

It is not possible to stir some foods to redistribute the heat. At times, microwave energy will concentrate in one area of a food. To help insure even cooking, these foods need to be turned. Turn over large foods, such as roasts or turkeys, halfway through cooking.

Stand Time

Most foods will continue to cook by conduction after the microwave oven is turned off. In meat cookery, the internal temperature will rise 5°F to 15°F (3°C to 8°C), if allowed to stand, tented with foil, for 10 to 15 minutes. Casseroles and vegetables need a shorter amount of standing time, but this standing time is necessary to allow foods to complete cooking to the center without overcooking on the edges.

Testing for Doneness

The same tests for doneness used in conventional cooking may be used for microwave cooking. Meat is done when fork-tender or splits at fibers. Chicken is done when juices are clear yellow and drumstick moves freely. Fish is done when it flakes and is opaque. Cake is done when a toothpick or cake tester is inserted and comes out clean. Candy is done when it reaches the proper temperature for each stage of crystallization.

Before Requesting Service

All these things are normal:

The oven causes interference with my TV.

Some radio and TV interference might occur when you cook with the microwave oven. This interference is similar to the interference caused by small appliances such as mixers, vacuums, blow dryers, etc.. It does not indicate a problem with your oven.

The oven light dims.

When cooking with a power other than P10 (HIGH), the oven must cycle to obtain the lower power levels. The oven light will dim and clicking noises can be heard when the oven cycles.

Steam accumulates on the oven door and warm air comes from the oven vents.

During cooking, steam and warm air are given off from the food. Most of the steam and warm air are removed from the oven by the air which circulates in the oven cavity. However, some steam will condense on cooler surfaces such as the oven door. This is normal.

I accidentally ran my microwave oven without any food in it.

Running the oven empty for a short time will not damage the oven. However, we do not recommend operating the microwave oven without any food in it.

PROBLEM

POSSIBLE CAUSE

ACTION

Oven will not turn on.



The oven is not plugged in securely.

Remove plug from outlet, wait 10 seconds and reinsert.

Circuit breaker or fuse is tripped or blown.

Reset circuit breaker or replace fuse.

There is a problem with the outlet.

Plug another appliance into the outlet to check if it is working.

Oven will not start cooking.



The door is not closed completely.

Close the oven door securely.

Start Pad was not pressed after programming.

Press **Start** Pad.

Another program is already entered into the oven.

Press **Stop/Reset** Pad to cancel the previous program and enter new program.

The program is not correct.

Program again according to the Operating Instructions.

Stop/Reset Pad has been pressed accidentally.

Program oven again.

The Glass Tray wobbles.



The Glass Tray is not positioned properly on the Roller Ring(s) or there is food under the Roller Ring(s).

Take out Glass Tray and Roller Ring(s). Wipe with a damp cloth and reset Roller Ring(s) and Glass Tray properly.

When the oven is operating, there is noise coming from the Glass Tray.



The Roller Ring(s) and oven bottom are dirty.

Clean according to **Care of Your Microwave Oven**.

Warranty & Service

PANASONIC/QUASAR MICROWAVE OVEN LIMITED WARRANTY

Panasonic Consumer Electronics Company or Panasonic Sales Company (collectively referred to as "the warrantor") will repair this product with new or refurbished parts in exchange for defective parts, free of charge, in the USA or Puerto Rico from the date of original purchase in the event of a defect in materials or workmanship as follows (all time periods start from the date of original purchase):

Parts - one (1) year (except magnetron).

Magnetron Tube - five (5) years.

Labor - one (1) year on all parts (including, without limitations, magnetron tube). After the labor warranty has expired, the purchaser pays for all labor charges for removal and installation of parts (including, without limitation, magnetron tube).

Carry-in or mail-in service in the USA or Puerto Rico can be obtained during the warranty period by contacting a Panasonic Services Company (PASC) Factory Servicenter listed in the Servicenter Directory. Or call, toll free, 1-800-211-PANA to locate a PASC authorized Servicenter. Carry-in or mail-in service in Puerto Rico can be obtained during the warranty period by calling the Panasonic Sales Company telephone number listed in the Servicenter Directory.

This warranty is extended only to the original purchaser. A purchase receipt or other proof of date of original purchase will be required before warranty service is rendered.

This warranty only covers failures due to defects in materials or workmanship which occur during normal use and does not cover glass, plastic parts, temperature probes (if included), and the exterior and interior finish. The warranty does not cover damages which occur in shipment, or failures which are caused by products not supplied by the warrantor, or

failures which result from accident, misuse, abuse, neglect, mishandling, misapplication, faulty installation, improper set-up adjustments, operation and/or maintenance, or alteration, modification, power line surge, improper voltage supply, lightning damage, or commercial use such as hotel, office, restaurant or other business or rental use of the product, or service by anyone other than a PASC Factory Servicenter or a PASC authorized Servicenter, or damage that is attributable to acts of God.

LIMITS AND EXCLUSIONS

There are no express warranties except as listed above. THE WARRANTOR SHALL NOT BE LIABLE FOR INCIDENTAL OR CONSEQUENTIAL DAMAGES RESULTING FROM THE USE OF THIS PRODUCT, OR ARISING OUT OF ANY BREACH OF THIS WARRANTY. ALL EXPRESS AND IMPLIED WARRANTIES, INCLUDING THE WARRANTIES OF MERCHANTABILITY, AND FITNESS FOR A PARTICULAR PURPOSE, ARE LIMITED TO THE APPLICABLE WARRANTY PERIOD SET FORTH ABOVE.

Some states do not allow the exclusion or limitation of incidental or consequential damages, or limitations on how long an implied warranty lasts, so the above exclusions or limitations may not apply to you.

This warranty gives you specific legal rights and you may also have other rights which vary from state to state. If a problem with this product develops during or after the warranty period, you may contact your dealer or Servicenter. If the problem is not handled to your satisfaction, then write to the Customer Satisfaction Center.

Web Site: <http://www.Panasonic.com>

You can purchase parts, accessories or locate your nearest servicenter by visiting our Web Site.

Factory Servicenters Locations

CALIFORNIA
6550 Katella Ave.
Cypress, CA 90630

800 Dubuque Ave.
S. San Francisco,
CA 94080

20201 Sherman Way
Suite 102
Canoga Park, CA 91306

3878 Ruffin Rd., Suite A
San Diego, CA 92123

COLORADO
1640 South Abilene Street
Suite D
Aurora, CO 80012

FLORIDA
3700 North 29th Ave.
Suite 102
Hollywood, FL 33020

GEORGIA
8655 Roswell Road
Suite 100
Atlanta, GA 30350

ILLINOIS
9060 Golf Road
Niles, IL 60714

1703 N. Randall Road
Elgin, IL 60123
(Pick up/Drop off only)

MARYLAND
62 Mountain Road
Glen Burnie, MD 21061

MASSACHUSETTS
60 Glacier Drive, Suite G
Westwood, MA 02090

MICHIGAN
37048 Van Dyke Ave.
Sterling Hts., MI 48312

MINNESOTA
7850-12th Ave. South
Airport Business Center
Bloomington, MN 55425

OHIO
2236 Waycross Road
Civic Center Plaza
Forest Park, OH 45240

PENNSYLVANIA
2221 Cabot Blvd. West
Suite B
Langhorne, PA 19047

TENNESSEE
3800 Ezell Road
Suite 806
Nashville, TN 37211

TEXAS
13615 Welch Road
Suite 101
Farmers Branch,
TX 75244

WASHINGTON
20425-84th Ave. South
Kent, WA 98032

HAWAII
99-859 Iwaiwa Street
Aiea, Hawaii 96701
Phone (808) 488-1996
Fax (808) 486-4639

Service in Puerto Rico

Matsushita Electric of Puerto Rico, Inc. Panasonic Sales Company / Factory Servicenter
Ave. 65 de Infanteria, Km. 9.5, San Gabriel Industrial Park, Carolina, Puerto Rico 00985
Phone (787) 750-4300 Fax (787) 768-2910

Quick Guide to Operation

| Feature | How to Operate |
|---|---|
| To Set Clock (☛ page 9) | Press. → 0 Thru 9 → Enter time of day. → Press. |
| To Cook Using Power and Time (☛ page 10) | Press to select power. → 0 Thru 9 → Set cooking time. → Press. |
| To use Function (☛ page 8) | Press. → 0 Thru 9 → Select category. → 1 or 2 or 3 → Select option. |
| To Defrost using Power & Time (☛ page 10) | Press 8 times to select P 3. → 0 Thru 9 → Enter defrost time. → Press. |
| Inverter Turbo Defrost (☛ page 11) | Press. → 0 Thru 9 → Enter weight. → Press. |
| To Cook using Popcorn (☛ page 11) | Press to select weight. → Press. |
| To Use as a Timer (☛ page 10) | Press. → 0 Thru 9 → Enter time. → Press. |
| To Set Standing Time (☛ page 10) | (Input up to 4-stage Cooking Program) → Press. → Stand time. → 0 Thru 9 → Enter time. → Press. |
| To Set Delay Time (☛ page 10) | Press. → Delay time. → 0 Thru 9 → Enter time. → (Input up to 4-stage Cooking Program) → Press. |
| To Cook using Quick Min (☛ page 9) | Tap desired number of times (up to 10). → Press. |
| To Cook using Sensor Cook (☛ page 12) | Press. → 0 Thru 9 → Select desired category (1-14). → Optional. → Optional on selected recipes. → Press. |
| To Reheat using Sensor Reheat (☛ page 12) | Press. → Optional. → Press. |
| To use Keep Warm (☛ page 9) | Press to select category. → Press. → Press. |