

This Owner's Manual is provided and hosted by [Appliance Factory Parts](#).



PANASONIC NN-S950BA Owner's Manual

[Shop genuine replacement parts for PANASONIC
NN-S950BA](#)



[Find Your PANASONIC Microwave Parts - Select From 742 Models](#)

----- Manual continues below -----

Panasonic®

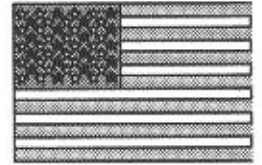

Operating Instructions

Microwave Oven

Models NN-N950 BA RPH / WA RPH
NN-S750 BA / BAS / WA / WAS
NN-S950 BA / BAS / WA / WAS

INVERTER
SYSTEM INSIDE

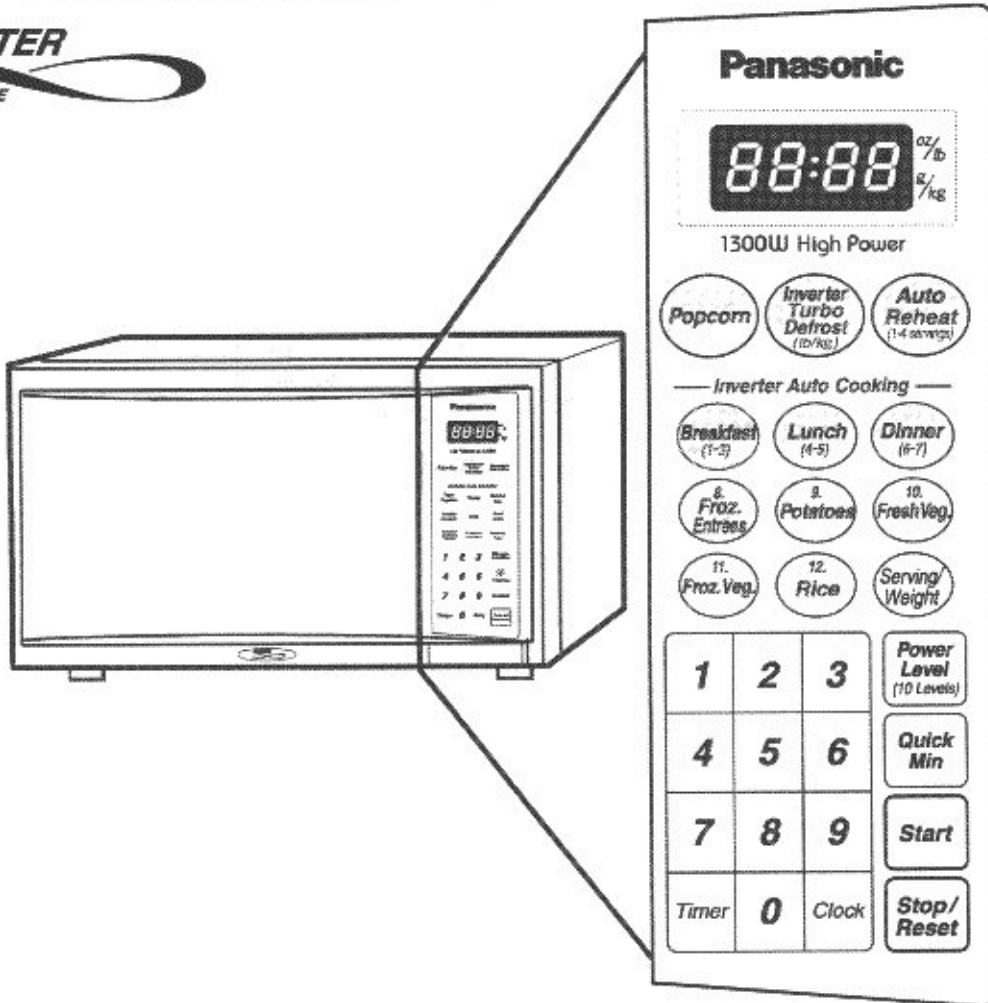

FOR ASSISTANCE:
Please call 1-800-211-PANA(7262)
-EMAIL TO
consumerproducts@panasonic.com
-REFER TO
<http://www.Panasonic.com>

This manual contains Safety Instructions, Operating Instructions and Maintenance of the oven.
For Cooking Guide and Parts information, see page 6.
Before operating this oven, please read these instructions completely.
Antes de operar este producto, lea este instructivo en su totalidad.
El manual de instrucciones en español puede ser encontrada en la páginas 21-37.

B00034U31AP
KY0300-0
Printed in U.S.A.

PRECAUTIONS TO AVOID POSSIBLE EXPOSURE TO EXCESSIVE MICROWAVE ENERGY

- (a) Do not attempt to operate this oven with the door open since open-door operation can result in harmful exposure to microwave energy. It is important not to defeat or tamper with the safety interlocks. Under normal conditions oven will not operate with door open.
- (b) Do not place any object between the oven front face and the door, or allow soil or cleaner residue to accumulate on sealing surfaces.
- (c) Do not operate the oven if it is damaged. It is particularly important that the oven door close properly and that there is no damage to the:
 - (1) door (bent)
 - (2) hinges and latches (broken or loosened)
 - (3) door seals and sealing surfaces.
- (d) The oven should not be adjusted or repaired by anyone except properly qualified service personnel.

STAPLE YOUR STORE RECEIPT HERE.

If you have any questions or it seems there is a problem with the oven, contact **PANASONIC / QUASAR / TECHNICS Customer Call Center** for assistance, 1-800-211-PANA(7262) {9 a.m. - 9 p.m., E.S.T., toll free}.

Visit our web site : <http://www.Panasonic.com>

**Thank you for purchasing a Panasonic Microwave Oven.
Before operating this oven please read these instructions completely.**

For Your Records

Model No. _____

Serial No. _____

Date of Purchase _____

TABLE OF CONTENTS

Before Operating

Precautions	Inside Front Cover
Important Safety Instructions	2
Installation Instructions and Grounding Instructions	3
Safety Precautions	4
Cookware and Utensil Guide	5
Feature Diagram	7
Control Panel	7

Operation

Let's Start to Use Your Oven!	8
Setting the Clock	8
Power and Time Setting	8
Popcorn	9
Using the Timer	9
Quick Min	10
Auto Reheat	10
Child Safety Lock	10
Inverter Auto Cook Pads	11
Inverter Turbo Defrost & Conversion Chart	12

Cooking Tips

Defrosting Tips & Techniques	13
Microwave Shortcuts	14
Food Characteristics	15
Cooking Techniques	15 - 16
Notes	18 - 19

Maintenance

Care of Your Microwave Oven	6
Parts and Order Form	6
Before Requesting Service	17
Warranty	37
Service Center List	37
Technical Specifications	Bottom of this page
Quick Guide to Operation	Back Cover

Manual de instrucciones (Spanish Operating Instructions)	20 - 36
---	---------

Technical Specifications

	NN-N950/ NN-S950	NN-S750
Power source:	120V, 60 Hz	120V, 60 Hz
Power consumption:	12.0 Amps 1,400 W	12.0 Amps 1,400 W
Output*:	1300 W	1300 W
Outside Dimensions: (H x W x D)	14" x 23 ⁷ / ₈ " x 19 ⁹ / ₁₆ " 356 x 606 x 497 mm	11 ¹⁵ / ₁₆ " x 21 ⁷ / ₈ " x 19 ⁹ / ₁₆ " 304 x 555 x 497 mm
Oven Capacity Dimensions: (H x W x D)	10 ¹⁵ / ₁₆ " x 18 ⁷ / ₁₆ " x 18 ¹ / ₂ " 278 x 469 x 470 mm	9" x 16 ⁷ / ₁₆ " x 18 ¹ / ₂ " 228 x 418 x 470 mm
Operating Frequency:	2,450 MHz	2,450 MHz
Uncrated Weight (Approx.):	36 lbs. (16.4 kg)	32 lbs. (14.3 kg)

Specifications subject to change without notice.

*IEC 705-88 Test procedure

IMPORTANT SAFETY INSTRUCTIONS

Your microwave oven is a cooking device and you should use as much care as you use with a stove or any other cooking device. When using this electric appliance, basic safety precautions should be followed, including the following:

WARNING—To reduce the risk of burns, electric shock, fire, injury to persons or exposure to excessive microwave energy:

1. Read all instructions before using the appliance.
2. Read and follow the specific **“PRECAUTIONS TO AVOID POSSIBLE EXPOSURE TO EXCESSIVE MICROWAVE ENERGY,”** found on back of the front cover.
3. This appliance must be grounded. Connect only to properly grounded outlet. See **“GROUNDING INSTRUCTIONS”** found on page 3.
4. Install or locate this appliance only in accordance with the installation instructions found on page 3.
5. Do not cover or block any openings on this appliance.
6. Do not store or use this appliance outdoors. Do not use this product near water—for example, near a kitchen sink, in a wet basement, or near a swimming pool, and the like.
7. Use this appliance only for its intended use as described in this manual. **DO NOT** use corrosive chemicals, vapours, or non-food products in this appliance. This type of oven is specifically designed to heat or cook. It is not designed for industrial or laboratory use. The use of corrosive chemicals in heating or cleaning will damage the appliance and may result in radiation leaks.
8. When cleaning surfaces of door and oven that come together on closing the door, use only mild, non-abrasive soaps or detergents applied with a sponge or soft cloth.
9. Do not allow children to use this appliance, unless closely supervised by an adult.
10. Do not operate this appliance if it has a damaged cord or plug, if it is not working properly, or if it has been damaged or dropped.
11. Do not immerse cord or plug in water.
12. Keep cord away from heated surfaces.
13. Do not let cord hang over edge of a table or counter.
14. This appliance should be serviced only by qualified service personnel. Contact the nearest authorized servicentre for examination, repair or adjustment.
15. Some products such as whole eggs, narrow neck bottles and sealed containers—for example, closed glass jars—may explode and should not be heated in this oven.
16. To reduce the risk of fire in the oven cavity:
 - (a) Do not overcook food. Carefully attend appliance if paper, plastic, or other combustible materials are placed inside the oven to facilitate cooking.
 - (b) Remove wire twist-ties from paper or plastic bags before placing bag in oven.

(c) If materials inside the oven should ignite, keep oven door closed, turn oven off, and disconnect the power cord, or shut off power at the fuse or circuit breaker panel.

(d) Do not use the cavity for storage purposes. Do not leave paper products, cooking utensils, or food in the cavity when not in use.

General Use

1. **DO NOT** tamper with or make any adjustments or repairs to door, control panel housing, safety interlock switches or any other part of the oven. **DO NOT** remove outer panel from oven. Repairs must be done only by a qualified service person.

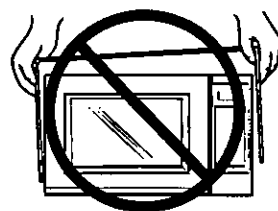

2. **DO NOT** operate the oven empty. The microwave energy will reflect continuously throughout the oven causing overheating, if food or water is not present to absorb energy. This could damage the oven and result in a risk of fire.

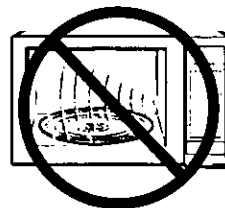

3. **DO NOT** dry clothes, newspapers or other materials in oven, or use newspapers or paper bags for cooking. Fire could result.
4. **DO NOT** use recycled paper products unless the paper product is labelled as safe for microwave oven use. Recycled paper products may contain impurities which may cause sparks, and result in fires when used.
5. **DO NOT** hit or strike control panel. Damage to controls may occur. Fire could result.
6. **POT HOLDERS** should always be used when removing items from the oven. Heat is transferred from the **HOT** food to the cooking container and from the cooking container to the Glass Tray. The Glass Tray can be very **HOT** after removing cooking container from oven.
7. **DO NOT** store flammable materials next to, on top of, or in the oven. These could be fire hazards.

SAVE THESE INSTRUCTIONS

For proper use of your oven read remaining safety cautions and operating instructions.

INSTALLATION & GROUNDING INSTRUCTIONS

Examine Your Oven

Unpack oven, remove all packing material and examine the oven for any damage such as dents, broken door latches or cracks in the door. Notify dealer immediately if oven is damaged.

DO NOT install if oven is damaged.

Placement of Oven

- Oven must be placed on a flat, stable surface. For proper operation, the oven must have sufficient air flow. Allow 3-inches (7.6 cm) of space on both sides of the oven and 1-inch (2.5 cm) of space on top of oven.
 - DO NOT** block air vents. If they are blocked during operation, the oven may overheat. If the oven overheats, a thermal safety device will turn the oven off. Unit should be taken to a Service Center.
 - DO NOT** place oven near a hot, damp surface such as a gas or electric range.
 - DO NOT** operate oven when room humidity is too high.
- This oven was manufactured for household use only.

Grounding Instructions

This appliance must be grounded. In the event of an electrical short circuit, grounding reduces the risk of electric shock by providing an escape wire for the electric current. This appliance is equipped with a cord having a grounding wire with a grounding plug. The plug must be plugged into an outlet that is properly installed and grounded.

WARNING—Improper use of the grounding plug can result in a risk of electric shock.

Consult a qualified electrician or service person if the grounding instructions are not completely understood or if doubt exists as to whether the appliance is properly grounded. If it is necessary to use an extension cord, use only a three wire extension cord that has a three blade grounding plug, and a three slot receptacle that will accept the plug on the appliance. The marked rating of the extension cord should be equal to or greater than the electrical rating of the appliance.

Power Supply

- A short power-supply cord is provided to reduce the risks resulting from becoming entangled in or tripping over a longer cord.
- Longer cord sets or extension cords are available and may be used if care is exercised in their use.
- If a long cord or extension cord is used, (a) the marked electrical rating of the cord set or extension cord should be at least as great as the electrical rating of the appliance, (b) the extension cord must be a grounding-type 3-wire cord, and (c) the longer cord should be arranged so that it will not drape over the counter top or tabletop where it can be pulled on by children or tripped over accidentally.

Wiring Requirements

- The oven must be on a **SEPARATE CIRCUIT**. No other appliance should share the circuit with the microwave oven. If it does, the branch circuit fuse may blow, the circuit breaker may trip, or the food may cook slower than the times recommended in this manual.
- The **VOLTAGE** used must be the same as specified on this microwave oven (120 V, 60 Hz). Using a higher voltage is dangerous and may result in a fire or other incident causing oven damage. Using a lower voltage will cause slow cooking. Panasonic is **NOT** responsible for damage resulting from the use of the oven with other than specified voltage.
- The oven must be plugged into at least a **20 AMP, 120 VOLT, 60 Hz GROUNDED OUTLET**. Where a standard two-prong outlet is encountered, it is the personal responsibility and obligation of the consumer to have it replaced with a properly grounded three-prong outlet.

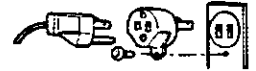

TV / Radio Interference

- Operation of the microwave oven may cause interference to your radio, TV or similar equipment.
- When there is interference, it may be reduced or eliminated by taking the following measures:
 - Clean door and sealing surfaces of the oven. (See Care of Your Microwave Oven)
 - Place the radio, TV, etc. away from the microwave oven as far as possible.
 - Use a properly installed antenna to obtain stronger signal reception.

Glass Tray

- DO NOT** operate the oven without Roller Ring and Glass Tray in place.
- DO NOT** operate the oven without the Glass Tray fully engaged on the drive hub. Improper cooking or damage to the oven could result. Verify that the Glass Tray is properly engaged and rotating by observing its rotation when you press **Start**.
- Only use Glass Tray specifically designed for this oven. Do not substitute any other glass tray.
- If Glass Tray is hot, allow to cool before cleaning or placing in water.
- DO NOT** cook directly on Glass Tray. Always place food in a microwave-safe dish, or on a rack set in a microwave-safe dish.
- If food or utensil on Glass Tray touches oven walls, causing the tray to stop moving, the tray will automatically rotate in opposite direction. This is normal.
- Glass Tray can turn in either direction.

Roller Ring

- Roller Ring and oven floor should be cleaned frequently to prevent excessive noise.
- Roller Ring must always be used for cooking along with Glass Tray.
- Always replace Roller Ring and Glass Tray in their proper positions.

Safety Precautions

Follow These Safety Precautions When Cooking in Your Oven

IMPORTANT

Proper cooking depends upon the power, the time set and the quantity of food. If you use a smaller portion than recommended and cook at the time for the recommended portion, fire could result.

1) HOME CANNING / DRYING FOODS / SMALL QUANTITIES OF FOODS

- **DO NOT** use your oven for home canning, your oven cannot maintain the food at the proper canning temperature. Improperly canned food may spoil and be dangerous to consume.
- **DO NOT** dry meats, herbs, fruits or vegetables in your oven. Small quantities of food or foods with low moisture content can dry out, scorch or catch on fire if overheated.

2) POPCORN

Popcorn may be popped in a microwave oven corn popper. Microwave popcorn which pops in its own package is also available. Follow popcorn manufacturers' directions and use a brand suitable for the wattage of your microwave oven.

CAUTION:

When using pre-packaged microwave popcorn, follow recommended package instructions. Check package weight before using the *Popcorn* pad (see *Popcorn Pad* section). Set the oven for the weight of the popcorn package.

If these instructions are not followed, the popcorn may not pop adequately or may ignite and cause a fire. Never leave oven unattended when popping popcorn. Allow the popcorn bag to cool before opening, always open the bag away from your face and body to prevent steam burns.

3) DEEP FAT FRYING

- **DO NOT** attempt to deep fat fry in your microwave oven. Cooking oils may burst into flames and may cause damage to the oven and perhaps result in burns. Microwave utensils may not be able to withstand the temperature of the hot oil, and could shatter or melt.

4) FOODS WITH NONPOROUS SKINS

- **Potatoes, apples, whole eggs, egg yolks, whole squash and sausages are examples of foods with nonporous skins.** These types of foods must be pierced before microwave cooking to prevent their bursting.
- Use fresh potatoes for baking and cook until just done. Use recommended weights for programmed cooking. Overcooking causes dehydration and may result in a fire.

5) LIQUIDS

- Heated liquids can erupt if not mixed with air. **DO NOT** heat liquids in your microwave oven without first stirring. Overheated liquids will erupt.

6) GLASS TRAY / COOKING UTENSILS / FOIL

- Cooking utensils get hot during microwaving. Heat is transferred from the HOT food to the container and the Glass Tray. Use potholders when removing utensils from the oven or when removing lids or plastic wrap covers from cooking utensils to avoid burns.
- The Glass Tray will get hot during cooking. It should be allowed to cool before handling or before paper products, such as paper plates or microwave popcorn bags, are placed in the oven for microwave cooking.
- When using foil, skewers, warming rack or utensils made of metal in the oven, allow at least 1-inch (2.5 cm) of space between metal material and interior oven walls. If arcing occurs (sparking), remove metal material (skewers, etc.) and/or transfer to a non-metallic container.
- Dishes with metallic trim should **not** be used, as arcing may occur.
- If an entree is heated in a foil tray, maintain at least 1-inch (2.5 cm) spacing from the oven walls.

7) PAPER TOWELS / CLOTHS

- **DO NOT** use paper towels or cloths which contain a synthetic fiber woven into them. The synthetic fiber may cause the towel to ignite. Use paper toweling under supervision.

8) BROWNING DISHES / OVEN COOKING BAGS

- Browning dishes or grills are designed for microwave cooking only. Always follow instructions provided by the manufacturer. **DO NOT** preheat browning dish more than 6 minutes.
- If an oven cooking bag is used for microwave cooking, prepare according to package directions. **DO NOT** use a wire twist-tie to close bag, instead use plastic ties, cotton string or a strip cut from the open end of the bag.

9) THERMOMETERS

- **DO NOT** use a conventional meat thermometer in your oven. Arcing may occur. Microwave-safe thermometers are available for both meat and candy.

10) BABY FORMULA / FOOD

- **DO NOT** heat baby formula or food in the microwave oven. The glass jar or surface of the food may appear to be only warm while the interior can be so hot as to burn the infant's mouth and esophagus.

11) REHEATING PASTRY PRODUCTS

- When reheating pastry products, check temperatures of any fillings before eating. Some foods have fillings which heat faster and can be extremely hot, while the surface remains warm to the touch (ex. Jelly Donuts).

12) GENERAL OVEN USAGE GUIDELINES

- **DO NOT** use the oven for any reason other than the preparation of food.
- **DO NOT** leave oven unattended while in use.

Cookware and Utensil Guide

ITEM	MICROWAVE	COMMENTS
Aluminum Foil	Yes, for Shielding only	Small strips of foil can be moulded around thin parts of meat or poultry to prevent overcooking. Arcing can occur if foil is too close to oven wall or if too much foil is used.
Browning Dish	Yes	Browning dishes are designed for microwave cooking only. Check browning dish information for instructions and heating chart. Do not preheat for more than 6 minutes.
Brown paper bags	No	May cause a fire in the oven.
Dinnerware Labeled "Microwave-Safe"	Yes	Check manufacturers' use and care directions for use in microwave heating. Some dinnerware may state on the back of the dish, "Oven-Microwave Safe".
Other Dinnerware	?	Use CONTAINER TEST below.
Disposable polyester Paperboard Dishes	Yes	Some frozen foods are packaged in these dishes. Can be purchased in grocery stores.
Fast Food Carton with Metal Handle	No	Metal handle may cause arcing.
Frozen Dinner Tray Metal	Yes	Frozen dinners may be heated in foil tray, if tray is less than 3/4-inch (2 cm) high. Place foil tray in center of oven. Leave at least 1-inch (2.5 cm) space between foil tray and oven walls. Heat only 1 foil tray in the oven at a time.
Microwave-safe	Yes	For containers more than 3/4-inch (2 cm) deep, remove food and place in a similar size microwave-safe container.
Glass Jars	Yes, use caution	Remove lid. Heat food until just warm, not HOT. Most glass jars are not heat resistant. Do not use for cooking.
Glassware Heat Resistant Oven Glassware & Ceramics	Yes	Ideal for microwave cooking and browning. (See CONTAINER TEST below).
Metal Bakeware	No	Not recommended for use in microwave ovens.
Metal Twist-Ties	No	May cause arcing which could cause a fire in the oven.
Oven Cooking Bag	Yes	Follow manufacturers' directions. Close bag with the nylon tie provided, a strip cut from the end of the bag or a piece of cotton string. Do not close with metal twist-tie. Make six 1/2-inch (1 cm) slits near the closure.
Paper Plates & Cups	Yes	Use to warm cooked foods and to cook foods that require short cooking times such as hot dogs.
Paper Towels & Napkins	Yes	Use to warm rolls and sandwiches by microwave.
Parchment Paper	Yes	Use as a cover to prevent spattering. Safe for use in microwave, microwave/convection and conventional ovens.
Plastic Microwave-Safe Cookware	Yes	Should be labeled, "Suitable for Microwave Heating." Check manufacturers' directions for recommended uses.
Reheat & Storage	Yes, use caution	Some microwave-safe plastic dishes are not suitable for cooking foods with high fat or sugar content. The heat from hot food may cause the plastic to warp.
Melamine	No	This material absorbs microwave energy. Dishes get HOT!
Plastic Foam Cups	Yes, use caution	Plastic foam will melt if foods reach a high temperature. Use to bring foods to a low serving temperature.
Plastic Wrap	Yes	Use to cover food during cooking to retain moisture and prevent spattering. Should be labeled "Suitable for Microwave Heating". Check package directions.
Straw, Wicker, Wood	Yes	Use only for short term reheating and to bring food to a low serving temperature.
Thermometers Microwave-safe, only	Yes	Use only microwave-safe meat and candy thermometers.
Conventional	No	Not suitable for use in microwave oven, will cause sparks and get hot.
Wax paper	Yes	Use as a cover to prevent spattering and to retain moisture.

CONTAINER TEST

TO TEST A CONTAINER FOR SAFE MICROWAVE OVEN USE: Fill a 1-cup glass measure with water and place it in the microwave oven along with the container to be tested; heat one (1) minute at P10 (HIGH). If the container is microwave oven-safe (transparent to microwave energy), the container should remain comfortably cool and the water should be hot. If the container is hot, it has absorbed some microwave energy and should NOT be used. This test cannot be used for plastic containers.

Care of Your Microwave Oven

BEFORE CLEANING:

Unplug at socket of the oven. If impossible, leave oven door open to prevent oven from accidentally turning on.

AFTER CLEANING:

Be sure to replace the Roller Ring and Glass Tray in the proper position and press **Stop/Reset** Pad to clear the screen.

Inside of the oven:

Wipe with a damp cloth. Mild detergent may be used if the oven gets very dirty. The use of harsh detergents or abrasives is not recommended.

Glass Tray:

Remove and wash in warm, soapy water or in a dishwasher.

Outside oven surfaces.

Clean with a damp cloth. To prevent damage to the operating parts inside the oven, water should not be allowed to seep into ventilation openings.

Menu Label:

Do not remove. Wipe with a damp cloth.

Control Panel:

- * Covered with a removable protective film to prevent scratches during shipping. Small bubbles may appear under this film. (Hint - To remove film, apply masking or clear tape to an exposed corner and pull gently.)
- * If the Control panel becomes wet, clean it with a soft, dry cloth. Clean control panel with a mild detergent.

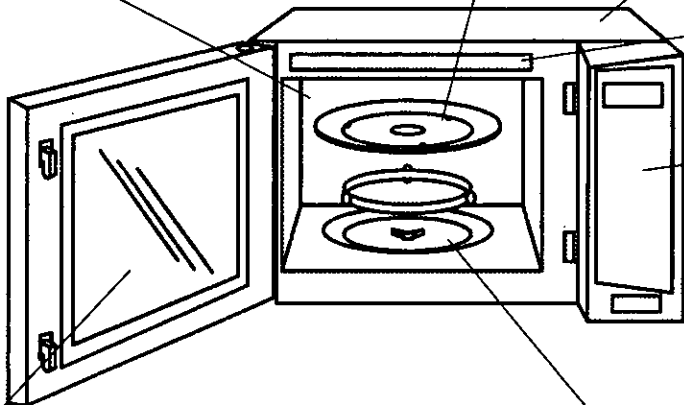

Oven Door:

- * Wipe with a soft cloth when steam accumulates inside or around the outside of the oven door. During cooking, especially under high humidity conditions, steam is given off from food. (Some steam will condense on cooler surfaces, such as the oven door. This is normal.)
- * Inside surface is covered with a heat and vapour barrier film. Do not remove.
- * Clean door surfaces (both sides) with a mild detergent. Do not use harsh detergents or abrasives.

Roller Ring and oven cavity floor:

Wipe the bottom surface of the oven with mild detergent, water or window cleaner and dry. Roller Ring may be washed in mild soapy water or in a dishwasher. These areas should be kept clean to avoid excessive noise.

ORDER FORM

For more information regarding microwave cooking, order our new **COOKING GUIDE** (68 pages of recipes & charts).

DESCRIPTION	PART NUMBER	PRICE
Instruction / Operating Manual (this book)	B00034U31AP	①
COOKING GUIDE	B000B8250AP	①
Glass Tray (see Care of Your Microwave Oven above)	B06014W00AP (NN-S750)	①
	A06014M00AP (NN-S950)(NN-N950)	①
Roller Ring Assembly	B290D4M00AP (NN-S750)	①
	B290D4M00AP (NN-S950)(NN-N950)	①

① For pricing quotes, call or write the Parts & Literature Department at the phone or address listed below. Please have your credit card information readily available.

Shipping & handling are not included. Price & availability subject to change. Sorry, no COD's.

PANASONIC SERVICES COMPANY
20421 84th Avenue South
Kent, WA 98032

(800) 833-9626 - Phone
(800) 237-9080 - FAX

Feature Diagram

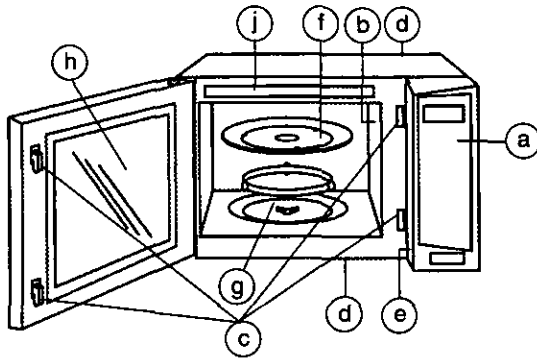

- (a) Control Panel
- (b) Internal Air Vents
- (c) Door Safety Lock System
- (d) External Air Vents
- (e) Identification Plate
- (f) Glass Tray
- (g) Roller Ring
- (h) Heat/Vapor Barrier Film (do not remove)
- (j) Menu Label

Control Panel

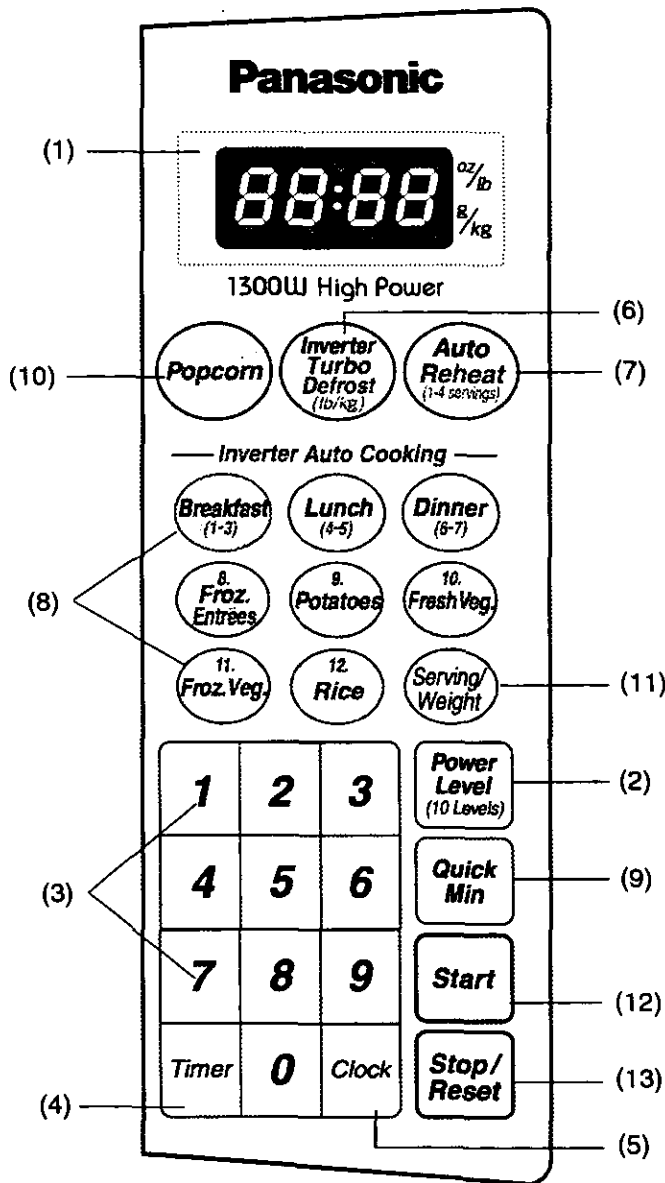

- (1) Display Window
- (2) Power Level Pad (page 8)
- (3) Number Pads
- (4) Timer Pad (page 9)
- (5) Clock Pad (page 8)
- (6) Inverter Turbo Defrost Pad (page 12)
- (7) Auto Reheat Pad (page 10)
- (8) Inverter Auto Cooking Pads (page 11)
- (9) Quick Min Pad (page 10)
- (10) Popcorn Pad (page 9)
- (11) Serving/Weight Pad (page 11)
- (12) Start Pad
One tap allows oven to begin functioning. If door is opened or **Stop/Reset** Pad is pressed once during oven operation, **Start** Pad must be pressed again to restart oven.
- (13) Stop/Reset Pad
Before cooking: One tap clears your instruction.
During cooking: One tap temporarily stops the cooking process. Another tap cancels all your instructions and time of day or dot appears on the **Display Window**.

Let's Start to Use Your Oven!

1. Plug into a properly grounded electrical outlet.



The oven automatically displays weights in imperial (oz/lb).

Display Window

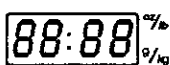

2. If you wish to use metric (g/kg):



Press **Start** to convert to metric. Verify your selection in the *Display Window*.

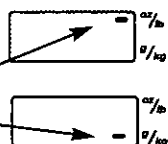

3.  Colon appears in *Display Window*. Press.

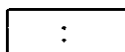

Now enjoy cooking with your Panasonic microwave.

Clock

This feature allows you to display the time of day. The oven will operate without setting the clock.

Example: To set 12:34 AM or PM.

1.  Press.

Display Window



Colon flashes.

2.  Enter time of day using number pads.

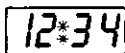

Colon continues flashing.

3.  Press **Clock** again to set time of day.

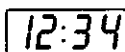

Colon stops flashing.

NOTES:



1. To reset the clock, repeat step 1 through 3.
2. The Clock will retain the time of day as long as electricity is supplied.
3. Clock is a 12 hour display.
4. Oven will not operate while colon is flashing.

Manual Operation (Power & Time Setting)

This feature allows you to manually set the power and time for microwave cooking.

Press **Power Level** pad until desired power appears in the *Display Window*. See Chart below.

Example: To cook at P 6 (MEDIUM) Power for 1 minute 30 seconds.

1.  *Display Window* shows P 6.
2.  Enter cooking time using number pads. *Display Window* shows 1.30.
3.  *Display Window* counts down. Press. *Display Window* shows 1:29.

At the end of cooking, five beeps sound and

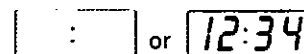

Colon or Time of day appears.

Press Power Level	Power Level
once	P10 (HIGH)
twice	P 9
3 times	P 8
4 times	P 7 (MED. HIGH)
5 times	P 6 (MEDIUM)
6 times	P 5
7 times	P 4
8 times	P 3 (MED. LOW)/ DEFROST
9 times	P 2
10 times	P 1 (LOW)

NOTES:



1. For more than one stage cooking, repeat steps 1 & 2 for each stage of cooking before pressing **Start** pad. Maximum number of stages for cooking is 5 stages.
2. When selecting P10 (HIGH) power for the first stage, you may begin at step 2.
3. Two beeps will sound between each stage of programming. Five beeps will sound at the end of the entire sequence.
4. When selecting P10 (HIGH) power, the maximum programmable time is 30 minutes. For other power levels, the maximum time is 99 minutes and 99 seconds.
5. For reheating, use P10 (HIGH) for liquids, P7 (MEDIUM-HIGH) for most foods and P6 (MEDIUM) for dense foods.
6. For defrosting, use P 3 (MEDIUM-LOW).

Timer

This feature allows you to:

- 1) Use it as a Kitchen **TIMER**.
- 2) Program **STAND** time after cooking is completed.
- 3) Program **DELAY** time for beginning cooking.

To Set TIMER:

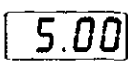
1.  *Display Window* goes blank. 
- Press once.
2.  Enter time using Number pads (up to 99 minutes and 99 seconds). 

To Activate TIMER Program:

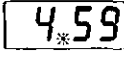
3.  *Timer* will count down. No cooking will occur. 
- Press once.

At the end of the time, 5 beeps sound and

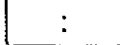
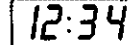
 or 
Colon Time of day appears.

NOTES:

1. When each stage finishes, a two beep signal sounds. At the end of the program, the oven will beep five times.
2. If oven door is opened during the TIMER/DELAY/STAND time, the time in the *Display Window* will continue to count down.
3. DELAY Time cannot be programmed before any Auto Control Feature. This is to prevent the starting temperature of the food from rising before defrosting or cooking begins. A change in the starting temperature would cause inaccurate cooking results.
4. Timer can be set up to 99 minutes and 99 seconds.

To Set DELAY time:

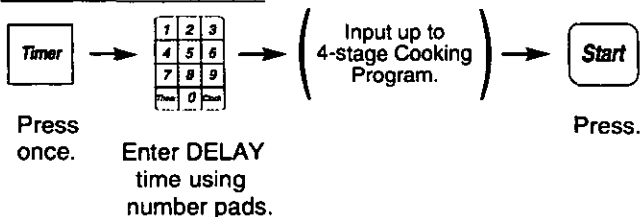

* Cooking will start after DELAY time has expired.

To Set STAND time:

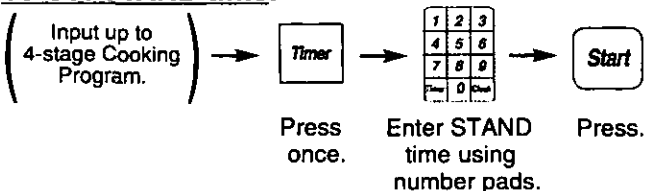







* STAND time will count down after cooking occurs.

Popcorn Pad

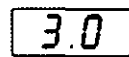
For use with prepackaged Popcorn bags.

Example: To pop 3.0 oz. (90 g) package of microwave popcorn.

Press *Popcorn* pad until package weight appears in the *Display Window*. See Chart below.

1.  Verify packaged weight. 
 - Press four times.
 2.  Cooking time* appears. 
 - Press. *Display Window* counts down. 
- At the end of cooking, five beeps sound and  or 
Colon Time of day appears.

Press <i>Popcorn</i> pad	Popcorn package	*Time
once	1.75 oz. (50 g)	will vary depending on size and wattage of oven
twice	2.65 oz. (75 g)	
three times	2.85 oz. (80 g)	
four times	3.0 oz. (90 g)	
five times	3.5 oz. (99 g)	

NOTES:

1. Popcorn packages should be at room temperature.
2. Place bag in oven according to manufacturer's directions.
3. Pop **one** bag at a time.
4. After popping, allow bag to cool. Carefully open bag away from face and body, since popcorn and steam are extremely hot.
5. Do not reheat unpopped kernels or reuse bag.
6. **NEVER** leave the oven unattended when popping popcorn. Stop the oven when popping slows to 2 to 3 seconds between pops. Overcooking may cause scorching.
7. With the many varieties of microwave popcorn available in the market place, it may be necessary for you to move the popcorn container to the outer edge of the glass tray to obtain the best cooking results.

Remarks:

When popping multiple bags one right after the other, the cooking times may vary slightly. This does not affect the popcorn results.

CAUTION: If pre-packaged popcorn is a different weight than is recommended, do not use the popcorn settings, or inadequate popping or a fire may occur. Follow the manufacturer's instructions.

Auto Reheat

This feature allows you to reheat up to 4 servings.

Example: To reheat 2 servings.



Press **Auto Reheat** pad until desired number of servings appears in the **Display Window**. See Chart below.

1.  **Display Window** 

Press 2 times.

2.  Cooking time* appears. 

Press. **Display Window** counts down. 

At the end of cooking  or  Time of day appears.

Press Auto Reheat pad to indicate number or servings	Average Serving Size	*Time
once	4 - 6 oz.	will vary depending on size and wattage of oven
twice	8 oz.	
three times	12 oz.	
four times	16 oz.	

NOTES: For best results, follow these recommendations:

- All foods must be previously cooked.
- Foods should always be covered loosely with plastic wrap, wax paper or casserole lid.
- All foods should have a covered stand time of 3 to 5 minutes.
- DO NOT** reheat bread and pastry products using **Auto Reheat**. Use manual power and time instead.
- DO NOT** reheat beverages.
- Times are based on an approximate serving size of 4 oz.
- A plate of food is normally 3 - 4 servings.

Child Safety Lock

This feature prevents the electronic operation of the oven until cancelled. It does **not** lock the door.

To Set:

1.  "Child" appears in **Display Window**. 

Press three times.

- * "Child" continues to be displayed until Child Lock is cancelled.
- * Keypads may be pressed but the microwave will not start.

To Cancel:

2.   or 

Press three times.



- * The **Display Window** will return to Colon or time of day when Child Lock has been cancelled.

Quick Min



This feature allows you to set and/or add cooking times easily in multiples of one minute.



To Set Cooking Time:

Example: 5 minutes

1.  Set cooking time. Power level is P10 (HIGH) 

Press. (up to 10)

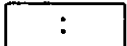
2.  Cooking begins and **Display Window** counts down. 

At the end of cooking, 5 beeps sound and  or  Time of day appears.

NOTES:



- To use with other power levels, Press **Power Level**, then **Quick Min**.
- If you use **Quick Min**, you can not use the Number Pads or vice versa.
- Press **Quick Min** to add more time during cooking. To verify the additional cooking time, check the **Display Window**.

Inverter Auto Cook Pads

This feature allows you to cook most of your favorite foods and some new recipes for the use in the Inverter Cooking System. With these codes you will find that you can cook without setting either the power or the time. These foods are tested and pre-timed for the quantity of food listed in the charts below. Locale, power fluctuations and individual tastes are not taken into account. Should you prefer your food cooked differently, use the Power and Time method shown on page 8.



AUTO COOK

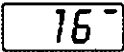

Example: To cook 16 oz. of Mixed Frozen Vegetables.

1.  Press. Display Window

2.  Verify Serving/Weight in *Display Window*. ^{7%}

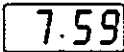
Press three times.

3.  Cooking time* appears in *Display Window*, and begins to count down. 
↓

4. At the end of the cooking sequence  or 
Colon Time of day appears.







*Time will vary according to the size and wattage of your oven.
The following are the recommended serving/weights:

MEAL	FOOD	SERVING/ WEIGHT	HINTS
Breakfast	1. <i>Oatmeal</i>	0.5, 1 cup	Place inside a microwave-safe serving bowl with no cover. Follow manufacturers' directions for preparation of quick meal
	2. <i>Beverages</i>	1, 2 cups	Use a microwave-safe coffee cup. Heated liquids can erupt if not mixed with air. Do not heat liquids in your microwave oven without stirring first
	3. <i>Bacon (slice)</i>	4, 6, 10, 14 slices	Place slices of bacon on a microwave-safe dish. Cover with paper towel. Times may vary by brand(weight).
Lunch	4. <i>Soup</i>	1, 2 cups	Pour soup into a microwave-safe dish. Cover loosely with lid or vented plastic wrap.
	5. <i>Frozen Pizza</i>	4, 8 oz.	Follow manufacturers' directions for preparation.
Dinner	6. <i>Chicken Pieces</i>	6, 12, 18, 24 oz.	Place skin side up .Cover with vented plastic wrap.
	7. <i>Ground Meat</i>	16, 32 oz.	Break apart in glass bowl or colander. Cover with vented plastic wrap. After 2 beeps, stir. Re-cover and press Start . Juices should be clear. Drain.
8. <i>Frozen Entrées</i>		8, 10, 20, 32 oz.	Follow manufacturers' directions for covering or removing covers. For best results, do not use frozen foods packaged in foil tray.
9. <i>Potatoes</i>		1, 2, 3, 4 pieces (6 - 8 ozs.)	Pierce skin with fork 6 times on top. Place potatoes on a microwave-safe dish. Do not cover. Let stand 5 minutes to complete cooking.
10. <i>Fresh Vegetables</i>		4, 8, 12, 16 oz.	All pieces should be the same size. Add a small amount of water and cover loosely with lid or vented plastic wrap.
11. <i>Frozen Vegetables</i>		6, 10, 16 oz.	Follow manufacturers' directions. Do not salt until after cooking. Not suitable for vegetables in butter or sauce.
12. <i>Rice</i>		0.5, 1, 1.5 cups	Place rice with hot water in a microwave-safe casserole dish. Cover loosely with lid or vented plastic wrap. Let stand 5 to 10 minutes before serving.

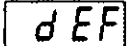
Inverter Turbo Defrost

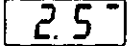
This feature allows you to defrost meat, poultry and seafood simply by entering the weight.

Example: To defrost 2.5 lbs. (2 lbs. 8 oz.) of meat.

- Display Window*
1.  "dEF" appears briefly in *Display Window*. 
Press.
 2.  Enter weight using number pads.  %
 3.  Defrost time* appears. 
Press. *Display Window* counts down. 

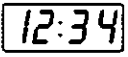
At the end of defrost, five beeps sound and  or 
Colon Time of day appears.

***NOTE:** Time will vary depending on size and wattage of your oven.

Conversion Chart

Follow this chart to convert ounces or hundredths of a pound into tenths of a pound.

Example: If a piece of frozen meat weighs 1 pound 14 ounces, the equivalent is 1.9 pounds.

Ounces	Hundredths of a Pound	Tenths of a Pound
0	.01 - .05	0.0
1 - 2	.06 - .15	0.1
3 - 4	.16 - .25	0.2
5	.26 - .35	0.3
6 - 7	.36 - .45	0.4
8	.46 - .55	0.5
9 - 10	.56 - .65	0.6
11 - 12	.66 - .75	0.7
13	.76 - .85	0.8
14 - 15	.86 - .95	0.9

Defrosting Tips & Techniques

Before Freezing:

1. Freeze meats, poultry and fish in packages with only 1 or 2 layers of food.
Place wax paper between layers.
2. Package in heavy-duty plastic wraps, bags (labeled "For Freezer") or freezer paper.
3. Remove as much air as possible, i.e. create a vacuum.
4. Seal securely, date and label.

To Defrost:

1. Remove wrapper. This helps moisture to evaporate.
Juices from food can get hot and cook the food.
2. Set food on microwave safe roasting rack in an appropriately sized dish.
3. Place roasts fat-side down. Place whole poultry breast-side down.
4. Drain liquids during defrosting.
5. Turn over (invert) items during defrosting.
6. Shield edges and ends if needed. (See **Cooking Techniques**).
7. Select power and minimum time so that items will be under-defrosted.

After Defrosting:

1. Large items may be icy in the center. Defrosting will complete during STANDING TIME.
2. Let stand, covered with plastic wrap, in the refrigerator for time shown in the chart below.
3. See chart below for standing time and rinsing directions.
4. Items which have been layered should be rinsed separately or have a longer stand time.

FOOD	DEFROST TIME (min. per pound) (P 3)	DURING DEFROSTING	AFTER DEFROSTING	
			Stand Time	Rinse (cold water)
Fish and Seafood (up to 3 lbs. (1.4 kg))				
Crabmeat	6	Break apart/Rearrange	5 min.	YES
Fish Steaks	4 to 6	Turn over		
Fish Fillets	4 to 6	Turn over/Rearrange/Shield ends		
Sea Scallops	4 to 6	Break apart/Remove defrosted pieces		
Whole fish	4 to 6	Turn over		
Meat				
Ground Meat	4 to 5	Turn over/Remove defrosted portion/Shield edges	10 min.	NO
Roasts [2½ - 4 lbs. (1.1-1.8 kg)]	4 to 8	Turn over/Shield ends and defrosted surface	30 min. in refrig	
Chops/Steak	6 to 8	Turn over/Rearrange/Shield ends and defrosted surface	5 min.	
Ribs/T-bone	6 to 8	Turn over/Rearrange/Shield ends and defrosted surface		
Stew Meat	4 to 8	Break apart/Rearrange/Remove defrosted pieces		
Liver (thin sliced)	4 to 6	Drain liquid/Turn over/Separate pieces	---	
Bacon (sliced)	4	Turn over	---	
Poultry				
Chicken, Whole (up to 3 lbs. (1.4 kg))	4 to 6	Turn over/Shield	20 min. in refrig.	YES
Cutlets	4 to 6	Break apart/Turn over/Remove defrosted pieces	5 min.	
Pieces	4 to 6	Break apart/Turn over/Shield	10 min.	
Cornish Hens	6 to 8	Turn over/Shield	20 min. in refrig	
Turkey Breast (5 - 6 lbs. (2.3 - 2.7 kg))	6	Turn over/Shield		

Microwave Shortcuts

FOOD	POWER SETTING	TIME (in minutes)	DIRECTIONS
To separate Bacon , 1 pound (450 g)	P10 (HIGH)	30 sec.	Remove wrapper and place in a microwave-safe dish. After heating, use a plastic spatula to separate slices.
To soften Brown Sugar 1 cup (250 mL)	P10 (HIGH)	20 - 30 sec.	Place brown sugar in microwave-safe dish with a slice of bread. Cover with plastic wrap.
To melt Butter , 1 stick, ¼ pound (110 g)	P6 (MEDIUM)	1½ - 2	Remove wrapper and place butter in a microwave-safe dish.
To soften Butter , 1 stick ¼ pound (110 g)	P3 (MEDIUM-LOW)	1	Remove wrapper and place butter in a microwave-safe dish covered with plastic wrap.
To melt Chocolate , 1 square, 1 oz. (28 g)	P10 (HIGH)	1 - 1½	Remove wrapper and place chocolate in a microwave-safe dish. Stir before adding more time. (Stir until completely melted.) <i>Note: Chocolate holds its shape even when softened.</i>
To melt Chocolate , ½ cup (125 mL) chips	P10 (HIGH)	1 - 1½	
To toast Coconut , ½ cup (125 mL)	P10 (HIGH)	1	Place in a microwave-safe dish. Stir every 30 seconds.
To soften Cream Cheese , 8 oz. (250 g)	P3 (MEDIUM-LOW)	1 - 2	Remove wrapper and place in a microwave-safe bowl.
To brown Ground Beef , 1 pound (450 g)	P10 (HIGH)	4 - 5	Crumble into a microwave-safe colander set into another dish. Stir twice. Drain grease.
To steam Hand Towels - 4	P10 (HIGH)	20 - 30 sec.	Soak in water, then wring out excess. Place on a microwave-safe dish. Heat. Present immediately.
To soften Ice Cream , ½ gallon (2 qt.)	P3 (MEDIUM-LOW)	1 - 1½	Check often to prevent melting.
Cup of liquid boiling water, broth, etc. 1 cup, 8 oz. (250 mL) 2 cups, 16 oz. (500 mL) to heat milk 1 cup, 8 oz. (250 mL) 2 cups, 16 oz. (500 mL)	P10 (HIGH) P7 (MEDIUM - HIGH)	2½ - 3 4 2 - 3 4 - 5	Heated liquids can erupt if not stirred. Do not heat liquids in your microwave oven without stirring before and after heating.
To roast Nuts , 1½ cups (375 mL)	P10 (HIGH)	4 - 5	
To toast Sesame Seeds , ¼ cup (50 mL)	P10 (HIGH)	3 - 5	Place in a small microwave-safe bowl. Stir twice.
To skin Tomatoes (one at a time)	P10 (HIGH)	30 sec.	Place tomato into a microwave-safe bowl containing boiling water. Rinse and peel. Repeat for each tomato.
To remove Cooking Odors	P10 (HIGH)	5	Combine 1 to 1½ cups (250 - 375 mL) water with the juice and peel of one lemon in a small microwave-safe bowl. After heating, wipe interior of oven with damp

Food Characteristics

Bone and Fat

Both bone and fat affect cooking. Bones may cause irregular cooking. Meat next to the tips of bones may overcook while meat positioned under a large bone, such as a ham bone, may be undercooked. Large amounts of fat absorb microwave energy and the meat next to these areas may overcook.

Density

Porous, airy foods such as breads, cakes or rolls take less time to cook than heavy, dense foods such as potatoes and roasts. When reheating donuts or other foods with different centers be very careful. Certain foods have centers made with sugar, water or fat and these centers attract microwaves (For ex., jelly donuts). When a jelly donut is heated, the jelly can become extremely hot while the exterior remains warm to the touch. This could result in a burn if the food is not allowed to cool properly in the center.

Quantity

Two potatoes take longer to cook than one potato. As the quantity of the food increases so does the cooking time. When cooking small amounts of food such as one or two potatoes, do not leave oven unattended. The moisture content in the food may decrease and a fire could result.

Shape

Uniform sizes heat more evenly. The thin end of a drumstick will cook more quickly than the meaty end. To compensate for irregular shapes, place thin parts toward the center of the dish and thick pieces toward the edge.

Size

Thin pieces cook more quickly than thick pieces.

Starting Temperature

Foods that are room temperature take less time to cook than if they are chilled or refrigerated or frozen.

Cooking Techniques

Piercing

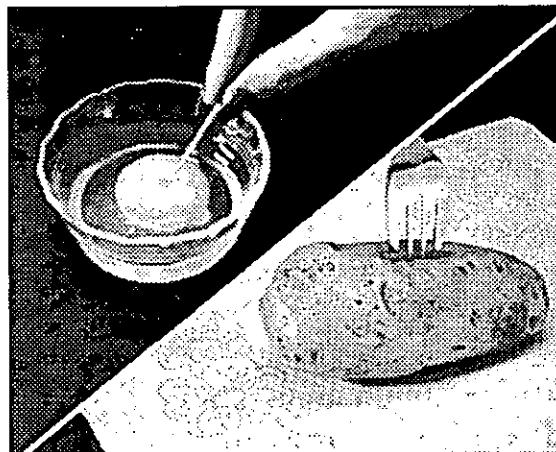

Foods with skins or membranes must be pierced, scored or have a strip of skin peeled before cooking to allow steam to escape. Pierce whole egg yolks and whites, clams, oysters, chicken livers, whole potatoes and whole vegetables. Whole apples or new potatoes should have a 1-inch strip of skin peeled before cooking. Score sausages and frankfurters.

Browning



Foods will not have the same brown appearance as conventionally cooked foods or these foods which are cooked utilizing a browning feature. Meats and poultry may be coated with browning sauce, Worcestershire sauce, barbecue sauce or shake-on browning sauce. To use, combine browning sauce with melted butter or margarine; brush on before cooking.

For quick breads or muffins, brown sugar can be used in the recipe in place of granulated sugar, or the surface can be sprinkled with dark spices before baking.

Cooking Techniques

Spacing

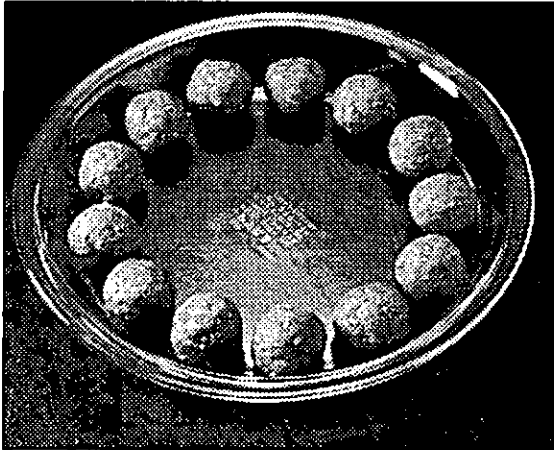

Individual foods, such as baked potatoes, cupcakes and appetizers, will cook more evenly if placed in the oven equal distances apart. When possible, arrange foods in a circular pattern.

Covering

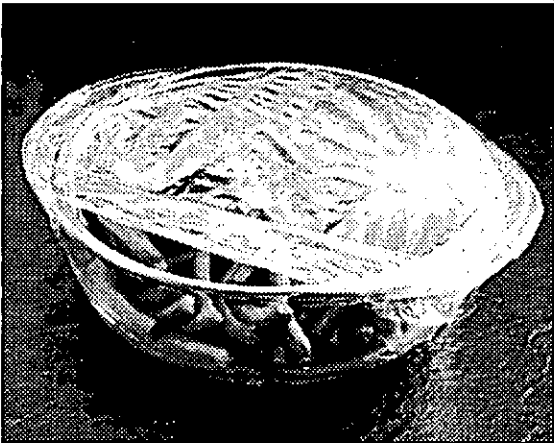

As with conventional cooking, moisture evaporates during microwave cooking. Casserole lids or plastic wrap are used for a tighter seal. When using plastic wrap, vent the plastic wrap by folding back part of the plastic wrap from the edge of the dish to allow steam to escape. Loosen or remove plastic wrap as recipe directs for stand time. When removing plastic wrap covers, as well as any glass lids, be careful to remove them away from you to avoid steam burns. Various degrees of moisture retention are also obtained by using wax paper or paper towels. However, unless specified, a recipe is cooked covered.

Shielding

Thin areas of meat and poultry cook more quickly than meaty portions. To prevent overcooking, these thin areas can be shielded with strips of aluminum foil. Wooden toothpicks may be used to hold the foil in place.

Timing

A range in cooking time is given in each recipe. The time range compensates for the uncontrollable differences in food shapes, starting temperature and regional preferences. Always cook food for the minimum cooking time given in a recipe and check for doneness. If the food is undercooked, continue cooking. It is easier to add time to an undercooked product. Once the food is overcooked, nothing can be done.

Stirring

Stirring is usually necessary during microwave cooking. We have noted when stirring is helpful, using the words once, twice, frequently or occasionally to describe the amount of stirring necessary. Always bring the cooked outside edges toward the center and the less cooked center portions toward the outside of the dish.

Rearranging

Rearrange small items such as chicken pieces, shrimp, hamburger patties or pork chops. Rearrange pieces from the edge to the center and pieces from the center to the edge of the dish.

Turning

It is not possible to stir some foods to redistribute the heat. At times, microwave energy will concentrate in one area of a food. To help insure even cooking, these foods need to be turned. Turn over large foods, such as roasts or turkeys, halfway through cooking.

Stand Time

Most foods will continue to cook by conduction after the microwave oven is turned off. In meat cookery, the internal temperature will rise 5°F to 15°F (3°C to 8°C), if allowed to stand, tented with foil, for 10 to 15 minutes. Casseroles and vegetables need a shorter amount of standing time, but this standing time is necessary to allow foods to complete cooking to the center without overcooking on the edges.

Testing for Doneness

The same tests for doneness used in conventional cooking may be used for microwave cooking. Meat is done when fork-tender or splits at fibers. Chicken is done when juices are clear yellow and drumstick moves freely. Fish is done when it flakes and is opaque. Cake is done when a toothpick or cake tester is inserted and comes out clean. Candy is done when it reaches the proper temperature for each stage of crystallization.

Before Requesting Service

All these things are normal:

The oven causes interference with my TV.

Some radio and TV interference might occur when you cook with the microwave oven. This interference is similar to the interference caused by small appliances such as mixers, vacuums, blow dryers, etc.. It does not indicate a problem with your oven.

The oven light dims.

When cooking with a power other than P10 (HIGH), the oven must cycle to obtain the lower power levels. The oven light will dim and clicking noises can be heard when the oven cycles.

Steam accumulates on the oven door and warm air comes from the oven vents.

During cooking, steam and warm air are given off from the food. Most of the steam and warm air are removed from the oven by the air which circulates in the oven cavity. However, some steam will condense on cooler surfaces such as the oven door. This is normal.

I accidentally ran my microwave oven without any food in it.

Running the oven empty for a short time will not damage the oven. However, we do not recommend operating the microwave oven without any food in it.

PROBLEM

POSSIBLE CAUSE

ACTION

Oven will not turn on.

The oven is not plugged in securely.

Remove plug from outlet, wait 10 seconds and reinsert.

Circuit breaker or fuse is tripped or blown.

Reset circuit breaker or replace fuse.

There is a problem with the outlet.

Plug another appliance into the outlet to check if it is working.

Oven will not start cooking.

The door is not closed completely.

Close the oven door securely.

Start Pad was not pressed after programming.

Press **Start** Pad.

Another program is already entered into the oven.

Press **Stop/Reset** Pad to cancel the previous program and enter new program.

The program is not correct.

Program again according to the Operating Instructions.

Stop/Reset Pad has been pressed accidentally.

Program oven again.

The Glass Tray wobbles.

The Glass Tray is not positioned properly on the Roller Ring or there is food under the Roller Ring.

Take out Glass Tray and Roller Ring. Wipe with a damp cloth and reset Roller Ring and Glass Tray properly.

When the oven is operating, there is noise coming from the Glass Tray.

The Roller Ring and oven bottom are dirty.

Clean according to **Care of Your Microwave Oven**.

The word "**Child**" appears in the **Display Window**.

The CHILD LOCK was activated by pressing **Start** pad 3 times.

Deactivate LOCK by pressing **Stop/Reset** pad 3 times.

Warranty & Service

PANASONIC/QUASAR MICROWAVE OVEN LIMITED WARRANTY

Panasonic Consumer Electronics Company or Panasonic Sales Company (collectively referred to as "the warrantor") will repair this product with new or refurbished parts in exchange for defective parts, free of charge, in the USA or Puerto Rico from the date of original purchase in the event of a defect in materials or workmanship as follows (all time periods start from the date of original purchase):

Parts - one (1) year (except magnetron).

Magnetron Tube - five (5) years.

Labor - one (1) year on all parts (including, without limitations, magnetron tube). After the labor warranty has expired, the purchaser pays for all labor charges for removal and installation of parts (including, without limitation, magnetron tube).

Carry-in or mail-in service in the USA or Puerto Rico can be obtained during the warranty period by contacting a Panasonic Services Company (PASC) Factory Servicenter listed in the Servicenter Directory. Or call, toll free, 1-800-211-PANA to locate a PASC authorized Servicenter. Carry-in or mail-in service in Puerto Rico can be obtained during the warranty period by calling the Panasonic Sales Company telephone number listed in the Servicenter Directory.

This warranty is extended only to the original purchaser. A purchase receipt or other proof of date of original purchase will be required before warranty service is rendered.

This warranty only covers failures due to defects in materials or workmanship which occur during normal use and does not cover glass, plastic parts, temperature probes (if included), and the exterior and interior finish. The warranty does not cover damages which occur in shipment, or failures which are caused by products not supplied by the warrantor, or

failures which result from accident, misuse, abuse, neglect, mishandling, misapplication, faulty installation, improper set-up adjustments, operation and/or maintenance, or alteration, modification, power line surge, improper voltage supply, lightning damage, or commercial use such as hotel, office, restaurant or other business or rental use of the product, or service by anyone other than a PASC Factory Servicenter or a PASC authorized Servicenter, or damage that is attributable to acts of God.

LIMITS AND EXCLUSIONS

There are no express warranties except as listed above.

THE WARRANTOR SHALL NOT BE LIABLE FOR INCIDENTAL OR CONSEQUENTIAL DAMAGES RESULTING FROM THE USE OF THIS PRODUCT, OR ARISING OUT OF ANY BREACH OF THIS WARRANTY. ALL EXPRESS AND IMPLIED WARRANTIES, INCLUDING THE WARRANTIES OF MERCHANTABILITY, AND FITNESS FOR A PARTICULAR PURPOSE, ARE LIMITED TO THE APPLICABLE WARRANTY PERIOD SET FORTH ABOVE.

Some states do not allow the exclusion or limitation of incidental or consequential damages, or limitations on how long an implied warranty lasts, so the above exclusions or limitations may not apply to you.

This warranty gives you specific legal rights and you may also have other rights which vary from state to state. If a problem with this product develops during or after the warranty period, you may contact your dealer or Servicenter. If the problem is not handled to your satisfaction, then write to the Customer Satisfaction Center.

Web Site: <http://www.Panasonic.com>

You can purchase parts, accessories or locate your nearest servicenter by visiting our Web Site.

Factory Service Centers

CALIFORNIA

6550 Katella Ave.
Cypress, CA 90630

800 Dubuque Ave.
S. San Francisco,
CA 94080

20201 Sherman Way
Suite 102
Canoga Park, CA 91306

3878 Ruffin Rd., Suite A
San Diego, CA 92123

COLORADO

1640 South Abilene Street
Suite D
Aurora, CO 80012

FLORIDA

3700 North 29th Ave.
Suite 102
Hollywood, FL 33020

GEORGIA

8655 Roswell Road
Suite 100
Atlanta, GA 30350

ILLINOIS

9060 Golf Road
Niles, IL 60714

1703 N. Randall Road
Elgin, IL 60123
(Pick up/Drop off only)

MARYLAND

62 Mountain Road
Glen Burnie, MD 21061

MASSACHUSETTS

60 Glacier Drive, Suite G
Westwood, MA 02090

MICHIGAN

37048 Van Dyke Ave.
Sterling Hts., MI 48312

MINNESOTA

7850-12th Ave. South
Airport Business Center
Bloomington, MN 55425

OHIO

2236 Waycross Road
Civic Center Plaza
Forest Park, OH 45240

PENNSYLVANIA

2221 Cabot Blvd. West
Suite B
Langhorne, PA 19047

TENNESSEE

3800 Ezell Road
Suite 806
Nashville, TN 37211

TEXAS

13615 Welch Road
Suite 101
Farmers Branch,
TX 75244

WASHINGTON

20425-84th Ave. South
Kent, WA 98032



































HAWAII

99-859 Iwaiwa Street
Aiea, Hawaii 96701
Phone (808) 488-1996
Fax (808) 486-4639

Service in Puerto Rico

Matsushita Electric of Puerto Rico, Inc. Panasonic Sales Company / Factory Servicenter
Ave. 65 de Infanteria, Km. 9.5, San Gabriel Industrial Park, Carolina, Puerto Rico 00985
Phone (787) 750-4300 Fax (787) 766-2910

Quick Guide to Operation

Feature	How to Operate
To Set Clock (☛page 8)	 →  Thru  →  Press. Enter time of day. Press.
To Cook Using Power and Time (☛page 8)	 →  Thru  →  Press to select power. Set cooking time. Press.
To Defrost using Power & Time (☛page 8)	 →  Thru  →  Press 8 times to select P3 Enter defrost time. Press.
Inverter Turbo Defrost (☛page 12)	 →  Thru  →  Press. Enter weight. Press.
To Cook using Popcorn (☛page 9)	 →  Press to select weight. Press.
To Use as a Timer (☛page 9)	 →  Thru  →  Press. Enter time. Press.
To Set Standing time (☛page 9)	Stand time. (Input up to 4-stage Cooking Program) →  →  Thru  →  Press. Enter time. Press.
To Set Delay time (☛page 9)	Delay time.  →  Thru  → (Input up to 4-stage Cooking Program) →  Press. Enter time. Press.
To Cook using Quick Min (☛page 10)	 →  Tap desired number of times (up to 10). Press.
To use Child Safety Lock (☛page 10)	 To Set: Press 3 times.  To Cancel: Press 3 times.