

This Owner's Manual is provided and hosted by [Appliance Factory Parts](#).



LG LSNC091PMA Owner's Manual

[Shop genuine replacement parts for LG LSNC091PMA](#)



[Find Your LG Air Conditioner Parts - Select From 2328 Models](#)

----- Manual continues below -----

INSTALLATION INSTRUCTIONS

SINGLE SPLIT WALL MOUNTED AIR CONDITIONER

ENGLISH

FRANÇAIS

ESPAÑOL

- Please read this instruction sheet completely before installing the product.
- When the power cord is damaged, replacement work shall be performed by authorized personnel only.
- Installation work must be performed in accordance with the national wiring standards by authorized personnel only.

Installation Parts Provided

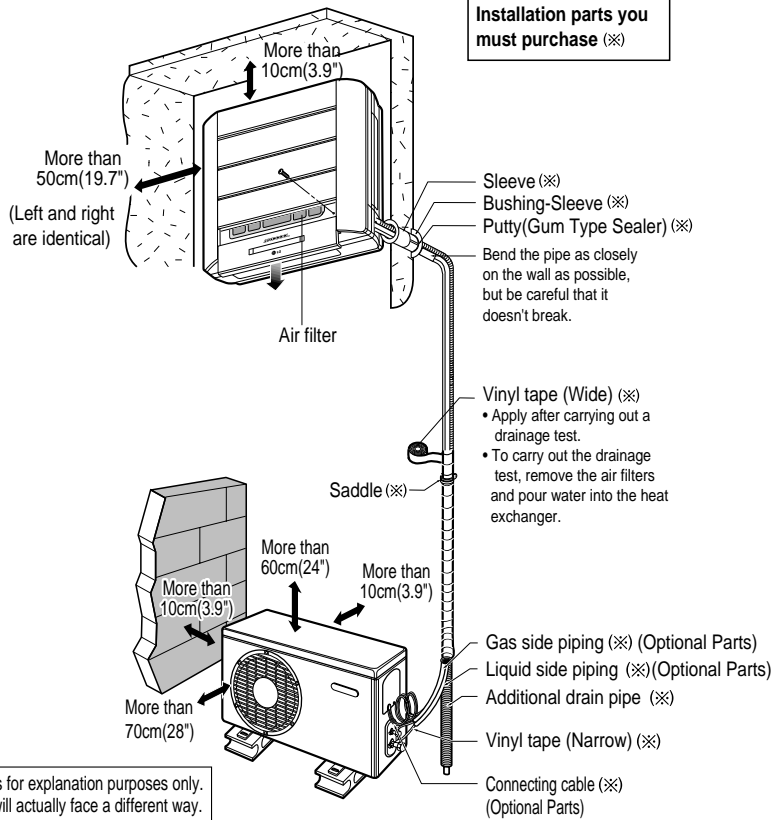
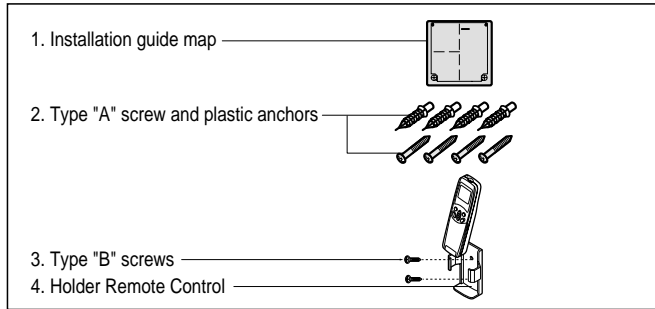

P/No.: 3828A20076P
(SP-Series)

INSTALLATION OVERVIEW

Installation Requirements

The following should be always observed for safety.....3

Installation of indoor, outdoor unit.....4

Flaring work and connection of piping7

Connecting the cable between indoor unit and outdoor unit..10

Checking the drainage and Forming the piping12

Air purging14

Panel Front Assembly16

Test running17

Required Parts

- Installation guide map
- Four type "A" screws & plastic anchors
- Connecting cable

- Pipes: Gas side1/2"
Liquid side1/4"
(Refer to page 4)
- Insulation materials
- Additional drain pipe
(Outer Diameter15.5mm(5/8"))

- Two type "B" screws

Required Tools

- Level gauge
- Screw driver
- Electric drill
- Hole core drill(ø50mm)
- Horizontal meter

- Flaring tool set
- Specified torque wrenches
Liquid side - 1.8kg.m(13ft.lbs):9K, 12K
Gas side - 5.5kg.m(39.8ft.lbs):9K, 12K
(different depending on model No.)
(Refer to page 10)
- Spanner.....Half union

- A glass of water
- Screw driver

- Hexagonal wrench 4mm(5/32")
- Gas-leak detector
- Vacuum pump
- Gauge manifold

- Owner's manual
- Thermometer
- Holder Remote Control

THE FOLLOWING SHOULD BE ALWAYS OBSERVED FOR SAFETY

- Be sure to read "THE FOLLOWING SHOULD BE ALWAYS OBSERVED FOR SAFETY" before installing the air conditioner.
- Be sure to observe the cautions specified here as they include important items related to safety.
- The indications and meanings are as follows.



WARNING

: Could lead to death, serious injury, etc.



CAUTION

: Could lead to serious injury in particular environments when operated incorrectly.

- After reading this instructions, be sure to keep it together with the owner's manual in a handy place on the customer's site.

ENGLISH



WARNING

Do not install it yourself (customer).

Incorrect installation could cause injury due to fire, electric shock, the unit falling or leakage of water. Consult the dealer from whom you purchased the unit or special installer.

Install the unit securely in a place which can bear the weight of the unit.

When installed in an insufficiently strong place, the unit could fall causing injury.

Use the specified wires to connect the indoor and outdoor units securely and attach the wires firmly to the terminal board connecting sections so the stress of the wires is not applied to the sections.

Incorrect connection and fixing could cause fire.

Attach the electrical part cover to the indoor unit and the service panel to the outdoor unit securely.

If the electrical part cover of the indoor unit and/or the service panel of the outdoor unit are not attached securely, it could result in a fire or electric shock due to dust, water, etc.

Perform the installation securely referring to the installation instruction.

Incorrect installation could cause a personal injury due to fire, electric shock, the unit falling or leakage of water.

Perform electrical work according to the installation manual and be sure to use an exclusive circuit.

If the capacity of the power circuit is insufficient or there is incomplete electrical work, it could result in a fire or an electric shock.

Check that the refrigerant gas does not leak after installation is completed.

Be sure to use the part provided or specified parts for the installation work.

The use of defective parts could cause an injury due to a fire, electric shock, the unit falling, etc.



CAUTION

Do not install the unit in a place where an inflammable gas leaks.

If gas leaks and accumulates in the area surrounding the unit, it could cause an explosion.

Perform the drainage/piping work according to the installation instruction.

If there is a defect in the drainage/piping work, water could leak from the unit and household goods could get wet and be damaged.

INSTALLATION OF INDOOR, OUTDOOR UNIT

Read completely, then follow step by step.



Select the best location

A Indoor unit

- Do not have any heat or steam near the unit.
- Select a place where there are no obstacles in front of the unit.
- Make sure that condensation drainage can be conveniently routed away.
- Do not install near a doorway.
- Ensure that the space around the left and right of the unit is more than 50cm(19.7"). The unit should be installed as high on the wall as possible, allowing a minimum of 10cm(3.9") from ceiling.
- Use a stud finder to locate studs to prevent unnecessary damage to the wall.

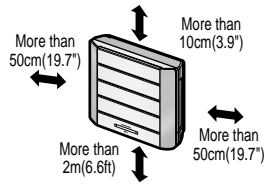

CAUTION

Install the indoor unit on the wall where the height from the floors more than 2 meters(6.6ft).

B Outdoor unit

- If an awning is built over the unit to prevent direct sunlight or rain exposure, make sure that heat radiation from the condenser is not restricted.
- Ensure that the space around the back and sides is more than 10cm(3.9"). The front of the unit should have more than 70cm(27.5") of space.
- Do not place animals and plants in the path of the warm air.
- Take the air conditioner weight into account and select a place where noise and vibration are minimum.
- Select a place so that the warm air and noise from the air conditioner do not disturb neighbors.

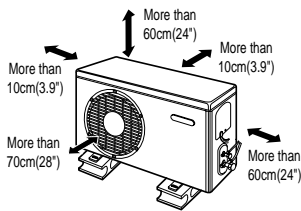

Rooftop Installations:

If the outdoor unit is installed on a roof structure, be sure to level the unit. Ensure the roof structure and anchoring method are adequate for the unit location. Consult local codes regarding rooftop mounting.

2 Piping length and elevation

Capacity (Btu/h)	Pipe Size		Standard Length (m)	Max. Elevation B (m)	Max. length A (m)	Additional Refrigerant (g/m)
	GAS	LIQUID				
9K	1/2"	1/4"	7.5 (24.6ft)	7 (23ft)	15 (50ft)	20
12K	1/2"	1/4"	7.5 (24.6ft)	7 (23ft)	15 (50ft)	20

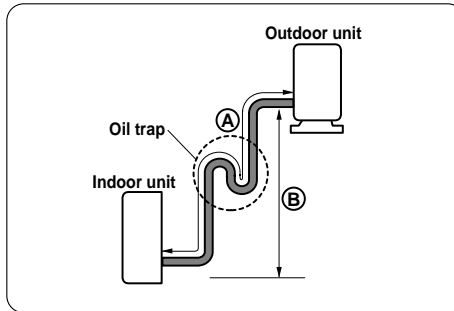
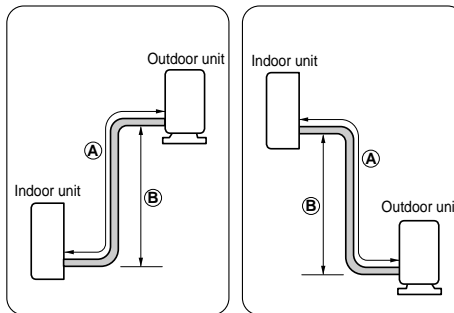

In case more than 5m(16.4ft)

CAUTION

- Capacity is based on standard length and maximum allowance length is on the basis of reliability.
- Oil trap should be installed every 5~7 meters(16.4~23ft).

3 Preparing work for Installation

A Open panel front

- First, Pull the grille bottom, then remove screws(2 pieces), and close grille bottom again.
- The moment of lifting the both lower parts of panel front, you can hear sound this panel came out, In this time panel front is separated
- After pull down this panel a bit, and separate connecting wire with product.

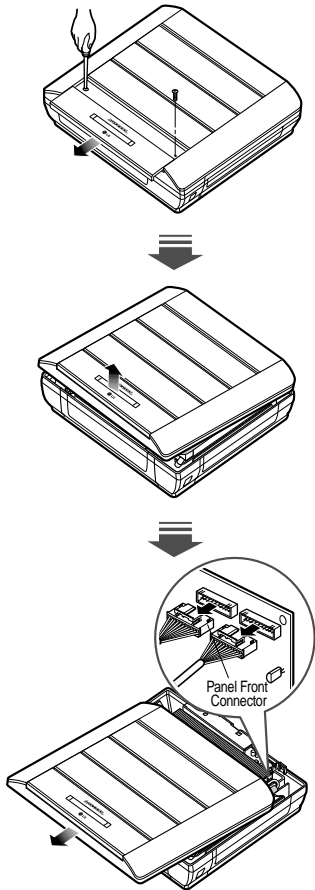

B Cover pipe and cover side remove

- Remove two screws(for fixing cover pipe)
- Pull up the cover side of desired connecting direction, then cover side is separated.
- In case connecting direction is left or right, path through the hole of cover side.

CAUTION

After removing the pipe hole, cut the burr for safety.

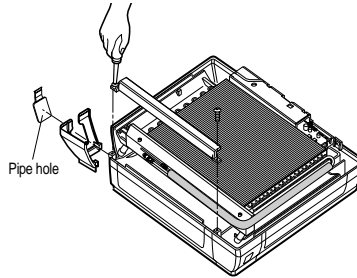

When connecting pipe path through rear wall, don't remove the hole.

C Drain hose junction

- Remove the rubber stopple of desired drain direction.
- As the following picture, Insert drain hose in the handle of drain pan, and join drain hose and connecting hose.

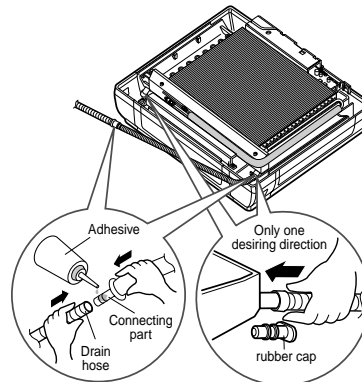

4 Sticking the installation guide map and fixing Indoor unit

- A** Put an Installation Guide Map on the desired surface.

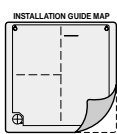

- C** Make a hole with diameter of 6mm(0.24") and depth of 30-35mm(1.18-1.38") when piercing a screw point.

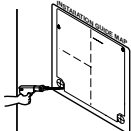

- E** Drive the fore plastic anchors into drilled points.

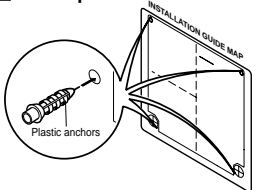

- G** Hang the hole of product at the upper screws. (In this time, Remove the map) (Falling attention)

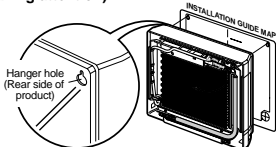

- I** Check the fixed product with light power.

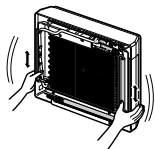

- B** Look at suited horizon by horizontal meter on the horizontal setting line, and Fix lightly the map by adhesive tape.

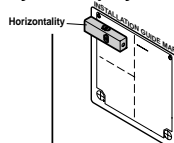

- D** Drill the piercing part for connecting pipe as diameter 50mm(1.97"). (In case of piercing rear surface)

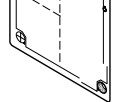

Refer to No. 5 on this page when making a hole in the wall.

- F** First, Drive the two points of the upper parts by screws. (Leave 10mm(0.39") for hanging product)

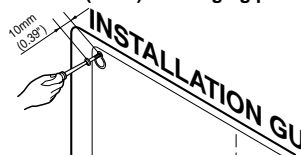

- H** Drive the lower parts after facing the hole of product with plastic anchors, and fix completely the upper screws.

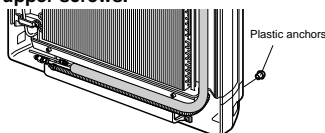

- J** In case of nothing wrong in the matter, connect the pipe and the wire. (Installation manual reference)

5 Preparing work for installation

- A** Drill a hole in the wall
- Drill the piping hole with a $\phi 50\text{mm}$ (1.97") hole core drill. Drill the piping hole at either the right or the left with the hole slightly slanted to the outdoor side.

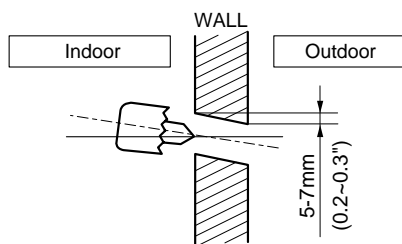

FLARING WORK AND CONNECTION OF PIPING

ENGLISH



Flaring work

Main cause for gas leakage is due to defect in flaring work. Carry out correct flaring work in the following procedure.

A Cut the pipes and the cable.

- Use the piping kit accessory or the pipes purchased locally.
- Measure the distance between the indoor and the outdoor unit.
- Cut the pipes a little longer than measured distance.
- Cut the cable 1.5m(4.9ft) longer than the pipe length.

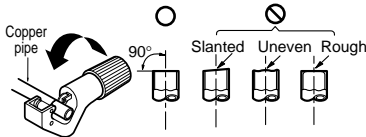

B Burrs removal

- Completely remove all burrs from the cut cross section of pipe/tube.
- Put the end of the copper tube/pipe in a downward direction as you remove burrs in order to avoid dropping burrs into the tubing.

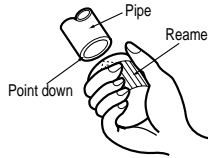

C Putting nut on

- Remove flare nuts attached to indoor and outdoor unit, then put them on pipe/tube having completed burr removal. (not possible to put them on after flaring work)

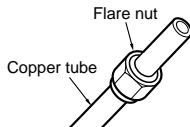

D Flaring work

- Carry out flaring work using flaring tool as shown below.

Outside diameter		A
mm	inch	mm
Ø6.35	1/4	0~0.5
Ø9.52	3/8	0~0.5
Ø12.7	1/2	0~0.5
Ø15.88	5/8	0~1.0

Firmly hold copper pipe in a die in the dimension shown in the table above.

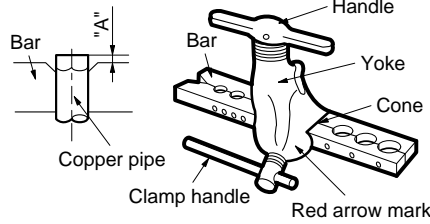

E Check

- Compare the flared work with figure below.
- If flare is noted to be defective, cut off the flared section and do flaring work again.

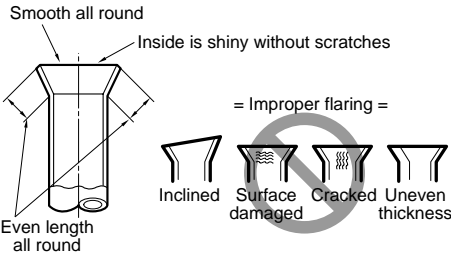

2 Connection of piping -Indoor

- Preparing the indoor unit's piping and drain hose for installation through the wall.

A Route the indoor tubing and the drain hose in the direction of rear left or right

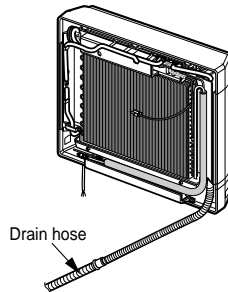

B Tape the tubing, drain hose and the connecting cable. Be sure that the drain hose is located at the lowest side of the bundle. Locating at the upper side can cause drain pan to overflow inside the unit.

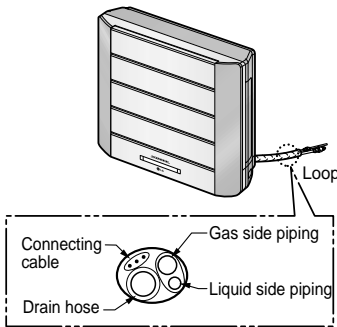

NOTE: If the drain hose is routed inside the room, insulate the hose with an insulation material* so that dripping from "sweating"(condensation) will not damage furniture or floors.
*Foamed polyethylene or equivalent is recommended.

C Connecting the pipings to the indoor unit and drain hose to drain pipe

- Align the center of the pipings and sufficiently tighten the flare nut by hand.

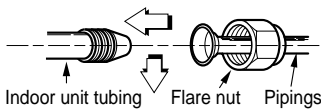

- Tighten the flare nut with a wrench.

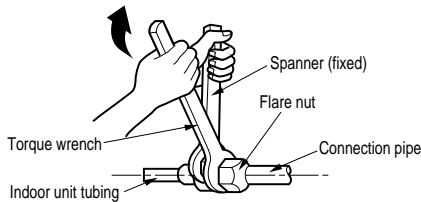

Capacity (Btu/h)	Pipe Size[Torque]	
	GAS	LIQUID
9K	1/2"[5.5kg.m]	1/4"[1.8kg.m]
12K	1/2"[5.5kg.m]	1/4"[1.8kg.m]

- When extending the drain hose at the indoor unit, install the drain pipe.

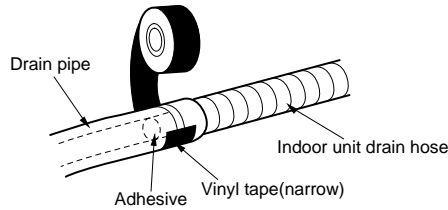

D Wrap the insulation material around the connecting portion.

- Overlap the connection pipe insulation material and the indoor unit pipe insulation material. Bind them together with vinyl tape so that there is no gap.

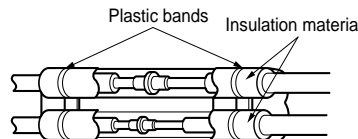

- Wrap the area which accommodates the rear piping housing section with vinyl tape.

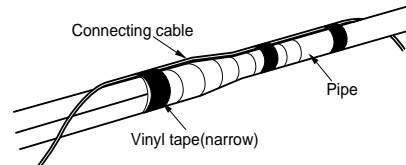
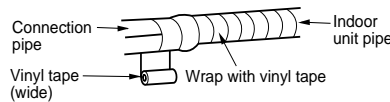

- Bundle the piping and drain hose together by wrapping them with vinyl tape over the range within which they fit into the rear piping housing section.

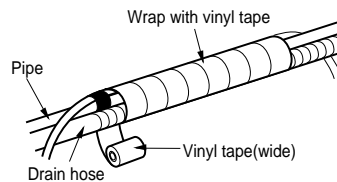

CAUTION

Installation Information (For right piping)

• **Good case**

For right piping, follow the instruction below.

- Press on the upper side of clamp and unfold the tubing to downward slowly.

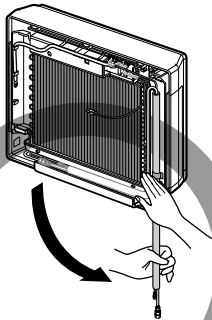

- Bend the tubing to the right side of chassis.

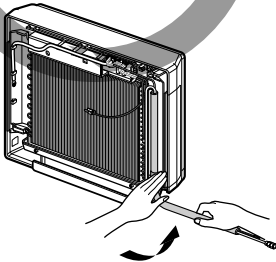

• **Bad case**

- Following bending type from right to left could cause problem of pipe damage.

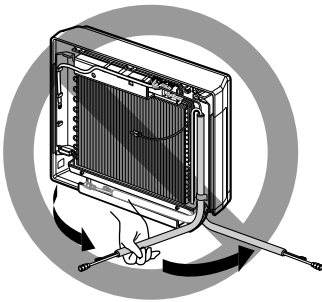

3 Connection of the pipes-Outdoor

- A** Align the center of the pipings and sufficiently tighten the flare nut by hand.

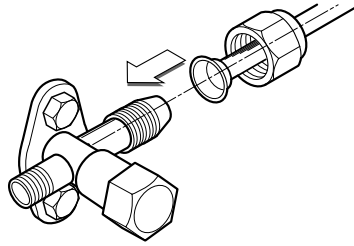

- B** Finally, tighten the flare nut with torque wrench until the wrench clicks.

- When tightening the flare nut with torque wrench, ensure the direction for tightening follows the arrow on the wrench.

Capacity (Btu/h)	Pipe Size[Torque]	
	GAS	LIQUID
9K	1/2"[5.5kg.m]	1/4"[1.8kg.m]
12K	1/2"[5.5kg.m]	1/4"[1.8kg.m]

Outdoor unit

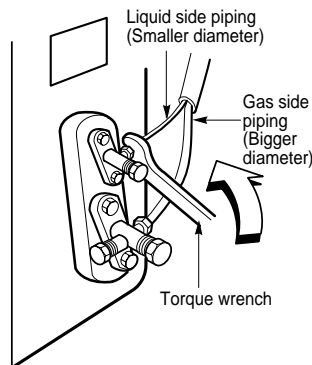

CONNECTING THE CABLE BETWEEN INDOOR UNIT AND OUTDOOR UNIT

Connection of the cable

1. Remove the cover control from the unit by loosening the 3 screws.
2. Dismount caps on the conduit panel.
3. Temporarily mount the conduit tubes on the conduit panel.
4. Properly connect both the power supply and low voltage lines to the corresponding terminals on the terminal block.
5. Ground the unit in accordance with local codes.
6. Be sure to size each wire allowing several inches longer than the required length for wiring.
7. Use lock nuts to secure the conduit tubes.

NOTE

Connector trade size for this unit is 1/2". Refer to "How to connect wiring to the terminals" for instructions on connecting depending on the wire type you are using.

WARNING

- Be sure to comply with local codes while running the wire from the indoor unit to the outdoor unit (size of wire and wiring method, etc).
- Every wire must be connected firmly.
- No wire should be allowed to touch refrigerant tubing, the compressor or any moving parts.

Power Supply

Model	Power source	AWG(MIN.)		Fuse or breaker Capacity
		Ⓐ	Ⓑ	
9K	1ø, 115V	14	18	15A
12K	1ø, 115V	14	18	20A

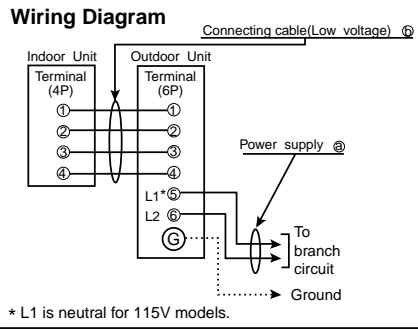

NOTE

1. shows field wiring.
2. Separately wire the high and low voltage line.
3. Use heat-proof electrical wiring capable of withstanding temperatures up to 167°F.
4. Use outdoor and waterproof connection cable rated more than 300V for the connection between indoor and outdoor unit. (For example, Type SJO-WA)

Outdoor unit

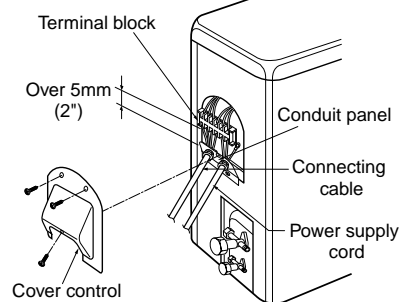

2 Connection method of the connecting cable (Example)

- (1) Dismount two-caps on the conduit panel.
- (2) Make a hole appropriate for the passage of connection cable through on cap by tool. (for low voltage line)
- (3) Pass the connecting cable through the hole.
- (4) Properly connect the cable on the terminal block.
- (5) Fix the connection cable with clamp cord provided on the unit not to have strain at the terminal when the connection cable is pulled outside up to a 35 pound weight.
- (6) Wind the vinyl tape round the connecting cable for sealing between the surface of the connection cable and cap.
- (7) Mount the taped part of cable on the cap.
- (8) Finally, mount the holed cap with the wound cable on the conduit panel.

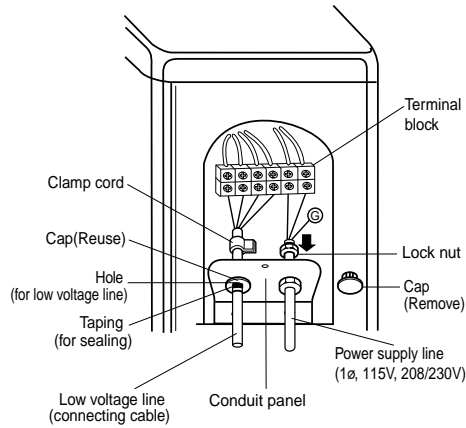

WARNING

Loose wiring may cause the terminal to overheat or result in unit malfunction. A fire hazard may also exist. Therefore, be sure all wiring is tightly connected.

When connecting each power wire to the corresponding terminal, follow instructions "How to connect wiring to the terminals" and fasten the wire tightly with the fixing screw of the terminal plate.

How to connect wiring to the terminals

■ For solid core wiring (or F-cable)

- (1) Cut the wire end with a wire cutter or wire-cutting pliers, then strip the insulation to expose the solid wire about 25mm(15/16")
- (2) Using a screwdriver, remove the terminal screw(s) on the terminal plate.
- (3) Using pliers, bend the solid wire to form a loop suitable for the terminal screw.
- (4) Shape the loop wire properly, place it on the terminal plate and tighten securely with the terminal screw using a screwdriver.

■ For strand wiring

- (1) Cut the wire end with a wire cutter or wire-cutting pliers, then strip the insulation to expose the strand wiring about 10mm(3/8").
- (2) Using a screwdriver, remove the terminal screw(s) on the terminal plate.
- (3) Using a round terminal fastener or pliers, securely clamp each stripped wire end with a round terminal.
- (4) Position the round terminal wire, and replace and tighten the terminal screw using a screwdriver.

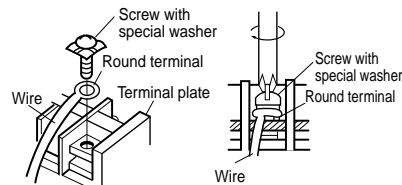
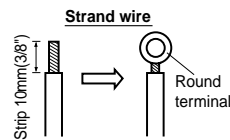
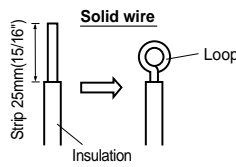

CHECKING THE DRAINAGE AND FORMING THE PIPINGS

1

Checking the drainage

A To check the drainage.

- Pour a glass of water on the evaporator.
- Ensure the water flows through the drain hose of the indoor unit without any leakage and goes out the drain exit.

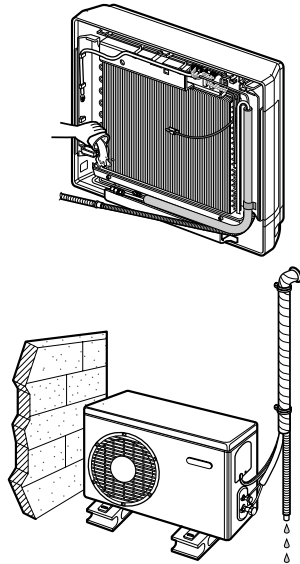

B Drain piping

- The drain hose should point downward for easy drain flow.

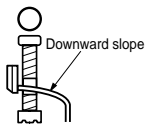

Do not make drain piping.

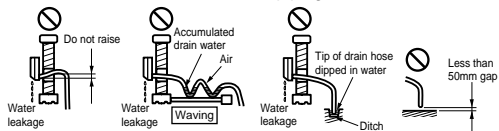

2

Form the piping

A Form the piping by wrapping the connecting portion of the indoor unit with insulation material and secure it with two kinds of vinyl tapes.

- If you want to connect an additional drain hose, the end of the drain outlet should be routed above the ground. Secure the drain hose appropriately.

B In cases where the outdoor unit is installed below the indoor unit perform the following.

- Tape the piping, drain hose and connecting cable from down to up.
- Secure the tapped piping along the exterior wall using saddle or equivalent.

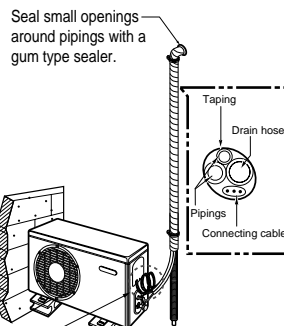

Trap is required to prevent water from entering into electrical parts.

C In cases where the Outdoor unit is installed above the Indoor unit perform the following.

- Tape the piping and connecting cable from down to up.
- Secure the taped piping along the exterior wall. Form a trap to prevent water entering the room.
- Fix the piping onto the wall by saddle or equivalent.

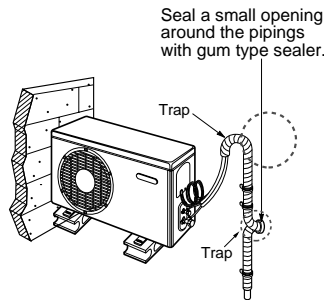

Seal a small opening around the pipings with gum type sealer.

CAUTION

If a power plug is not to be used, provide a circuit breaker between power source and the unit as shown below.

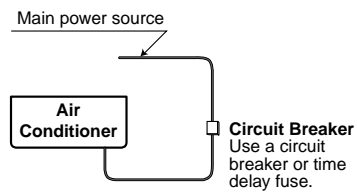

3 Connect the cable to the indoor unit

1. Connect the wires to the terminals on the control board individually according to the outdoor unit connection.

- Ensure that the color of the wires of outdoor unit and the terminal No. are the same as those of indoor unit respectively.

(Refer to Wiring diagram on page10.)

WARNING

- Be sure to refer to the wiring diagram label inside the cover control and carry out the correct field wiring. Wrong wiring can cause the unit to misoperate to result in a fire hazard.
- Check local electrical codes and any specified wiring instructions or limitations.

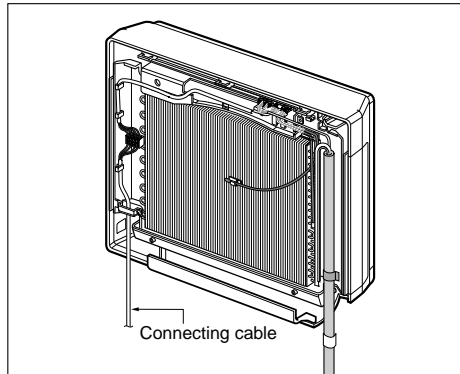



Air purging

Air and moisture remaining in the refrigerant system have undesirable effects as indicated below.

- Pressure in the system rises.
- Operating current rises.
- Cooling(or heating) efficiency drops.
- Moisture in the refrigerant circuit may freeze and block capillary tubing.
- Water may lead to corrosion of parts in the refrigeration system.

Therefore, the indoor unit and tubing between the indoor and outdoor unit must be leak tested and evacuated to remove any noncondensables and moisture from the system.



Air purging with vacuum pump

A Preparation

- Check that each tube(both liquid and gas side tubes) between the indoor and outdoor units have been properly connected and all wiring for the test run has been completed. Remove the service valve caps from both the gas and the liquid side on the outdoor unit. Note that both the liquid and the gas side service valves on the outdoor unit are kept closed at this stage.

B Leak test

- Connect the manifold valve(with pressure gauges) and dry nitrogen gas cylinder to this service port with charge hoses.

CAUTION

Be sure to use a manifold valve for air purging. If it is not available, use a stop valve for this purpose. The "Hi" knob of the manifold valve must always be kept close.

- Pressurize the system to no more than 150 P.S.I.G. with dry nitrogen gas and close the cylinder valve when the gauge reading reached 150 P.S.I.G. Next, test for leaks with liquid soap.

CAUTION

To avoid nitrogen entering the refrigerant system in a liquid state, the top of the cylinder must be higher than its bottom when you pressurize the system. Usually, the cylinder is used in a vertical standing position.

- Do a leak test of all joints of the tubing(both indoor and outdoor) and both gas and liquid side service valves.
Bubbles indicate a leak. Be sure to wipe off the soap with a clean cloth.
- After the system is found to be free of leaks, relieve the nitrogen pressure by loosening the charge hose connector at the nitrogen cylinder. When the system pressure is reduced to normal, disconnect the hose from the cylinder.

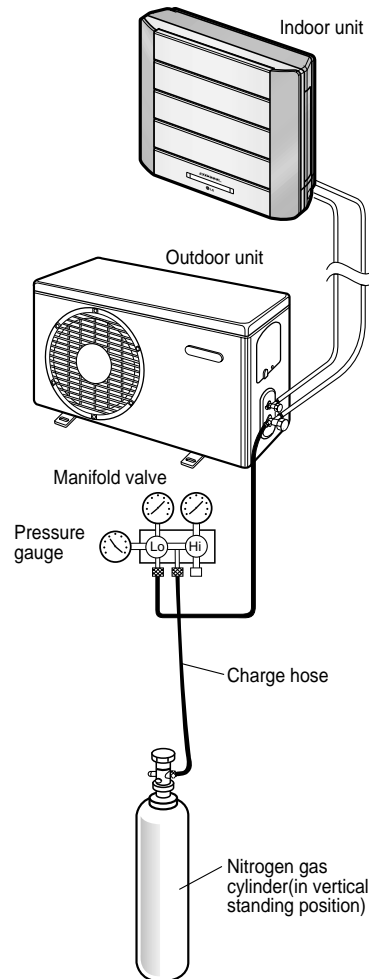

Soap water method

- (1) Remove the caps from the 2-way and 3-way valves.
- (2) Remove the service-port cap from the 3-way valve.
- (3) To open the 2-way valve turn the valve stem counterclockwise approximately 90°, wait for about 2–3 sec, and close it.
- (4) Apply a soap water or a liquid neutral detergent on the indoor unit connection or outdoor unit connections by a soft brush to check for leakage of the connecting points of the piping.
- (5) If bubbles come out, the pipes have leakage.

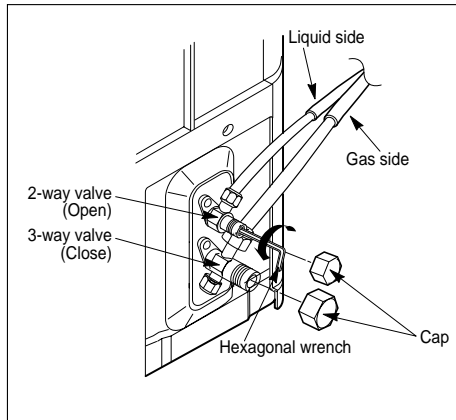

C Evacuation

- Connect the charge hose end described in the preceding steps to the vacuum pump to evacuate the tubing and indoor unit. Confirm the "Lo" knob of the manifold valve is open. Then, run the vacuum pump. The operation time for evacuation varies with tubing length and capacity of the pump. The following table shows the time required for evacuation.

Required time for evacuation when 30 gal/h vacuum pump is used	
If tubing length is less than 10m (33 ft)	If tubing length is longer than 10m (33 ft)
10 min. or more	15 min. or more

- When the desired vacuum is reached, close the "Lo" knob of the manifold valve and stop the vacuum pump.

D Finishing the job

- With a service valve wrench, turn the valve stem of liquid side valve counter-clockwise to fully open the valve.
- Turn the valve stem of gas side valve counter-clockwise to fully open the valve.
- Loosen the charge hose connected to the gas side service port slightly to release the pressure, then remove the hose.
- Replace the flare nut and its bonnet on the gas side service port and fasten the flare nut securely with an adjustable wrench. This process is very important to prevent leakage from the system.
- Replace the valve caps at both gas and liquid side service valves and fasten them tight.

This completes air purging with a vacuum pump. The air conditioner is now ready to test run.

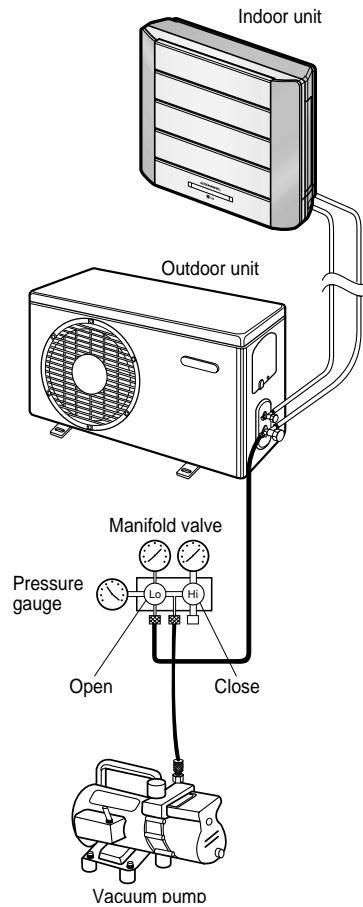

PANEL FRONT ASSEMBLY

- A** First, Check the side cover assembly exactly,
Fix power cord in the bottom groove of cover
side left.

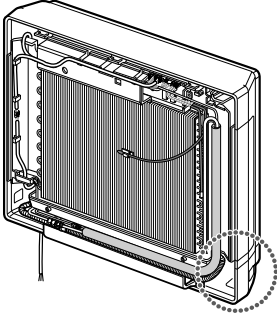

- C** Drive two screws.

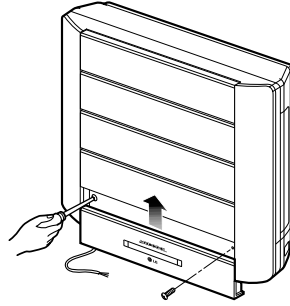

- B** Assemble connecting lead wire with controller
and first fix the upper part of panel front, then
match the lower part of panel front

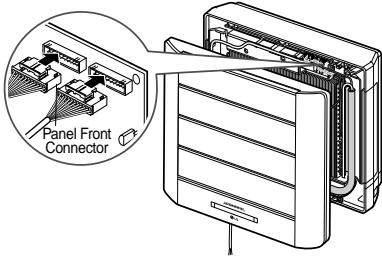

TEST RUNNING

ENGLISH

1. Check that all tubing and wiring have been properly connected.
2. Check that the gas and liquid side service valves are fully open.

A Prepare remote control

1. Remove the battery cover by pulling it according to the arrow direction.
2. Insert new batteries making sure that the (+) and (-) of battery are installed correctly.
3. Reattach the cover by pushing it back into position.

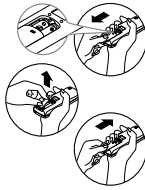

NOTE:

- Use 2 AAA(1.5volt) batteries. Do not use rechargeable batteries.
- Remove the batteries from the remote control if the system is not going to be used for a long time.

B Settlement of outdoor unit

- Anchor the outdoor unit with a bolt and nut($\phi 10\text{mm}(0.39\text{'})$) tightly and horizontally on a concrete or rigid mount.
- When installing on the wall, roof or rooftop, anchor the mounting base securely with a nail or wire assuming the influence of wind and earthquake.
- In the case when the vibration of the unit is conveyed to the hose, secure the unit with an anti-vibration rubber.

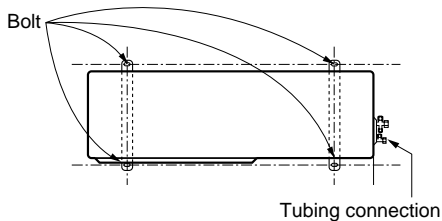

C Evaluation of the performance

Operate unit for 15~20 minutes, then check the system refrigerant charge:

1. Measure the pressure of the gas side service valve.
2. Measure the temperature of the intake and discharge of air.

3. Ensure the difference between the intake temperature and the discharge is more than $46.4^{\circ}\text{F}(8^{\circ}\text{C})$

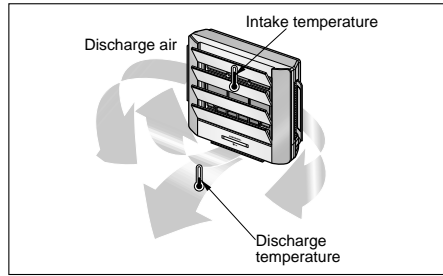

4. For reference; the gas side pressure of optimum condition is as below. (Cooling)

Refrigerant	Outside ambient TEMP.	The pressure of the gas side service valve.
R-22	95°F (35°C)	4~5kg/cm ² G(56.8~71.0 P.S.I.G.)

NOTE: If the actual pressure are higher than shown, the system is most likely over-charged, and charge should be removed. If the actual pressure are lower than shown, the system is most likely undercharged, and charge should be added. The air conditioner is now ready for use.

PUMP DOWN

This is performed when the unit is to be relocated or the refrigerant circuit is serviced. Pump Down means collecting all refrigerant in the outdoor unit without loss in refrigerant gas.

CAUTION:

Be sure to perform Pump Down procedure with the unit cooling mode.

Pump Down Procedure

1. Connect a low-pressure gauge manifold hose to the charge port on the gas side service valve.
2. Open the gas side service valve halfway and purge the air from the manifold hose using the refrigerant gas.
3. Close the liquid side service valve(all the way in).
4. Turn on the unit's operating switch and start the cooling operation.
5. When the low-pressure gauge reading becomes 1 to 0.5kg/cm² G(14.2 to 7.1 P.S.I.G.), fully close the gas side valve stem and then quickly turn off the unit. At that time, Pump Down has been completed and all refrigerant gas will have been collected in the outdoor unit.

