

This Owner's Manual is provided and hosted by [Appliance Factory Parts](#).

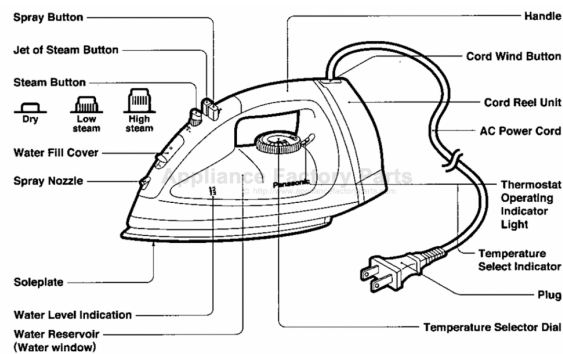

PANASONIC NI-552R Owner's Manual

[Shop genuine replacement parts for PANASONIC
NI-552R](#)



[Find Your PANASONIC Small Appliance Parts - Select From 148 Models](#)

----- Manual continues below -----

Panasonic®

Electric Steam Iron Operating Instructions

Model No. NI-350S/NI-350R/NI-552R/NI-553R/NI-560R/NI-R20NR
NI-R15NR/NI-R16NR



Please read these instructions carefully before using this product and save this manual for future use.

For assistance, please call : 1-800-211-PANA (7262)
or send e-mail to : consumerproducts@panasonic.com
or visit us at www.panasonic.com

(U.S.A)

For assistance, please call : 787-757-4300
or visit us at www.panasonicpr.com

(Puerto Rico)

IMPORTANT SAFEGUARDS

When using your flatiron, basic safety precautions should always be followed, including the following:

1. Read all instructions.
2. Use iron only for its intended use.
3. To protect against a risk of electric shock, do not immerse the iron in water or other liquids.
4. The iron should always be turned to OFF before plugging or unplugging from outlet. Never yank cord to disconnect from outlet; instead, grasp plug and pull to disconnect.
5. Do not allow cord to touch hot surfaces. Let iron cool completely before putting away.
Loop cord loosely around iron when storing. (NI-350S Only)
Wind cord into cord reel unit when storing.
(NI-350R/552R/553R/560R/R20NR/R15NR/R16NR Only)
6. Always disconnect iron from electrical outlet when filling with water or emptying and when not in use.
7. Do not operate iron with a damaged cord or if the iron has been dropped or damaged. To avoid a risk of electric shock, do not disassemble the iron, take it to a qualified serviceman for examination and repair.
Incorrect reassembly can cause a risk of electric shock when the iron is used.
8. Close supervision is necessary for any appliance being used by or near children. Do not leave iron unattended while connected or on an ironing board.
9. Burns can occur from touching hot metal parts, hot water, or steam. Use caution when you turn a steam iron upside down-there may be hot water in the reservoir.

SPECIAL INSTRUCTIONS

1. To avoid a circuit overload, do not operate another high wattage appliance on the same circuit.
2. If an extension cord is absolutely necessary, a 10 ampere cord should be used. Cords rated for less amperage may overheat. Care should be taken to arrange the cord so that it cannot be pulled or tripped over.

SAVE THESE INSTRUCTIONS

© 1995 Matsushita Electric Industrial Co., LTD. All rights reserved.

COMPONENTS IDENTIFICATION

NI-350R / 552R / 553R / R20NR

(This picture is NI-350R)

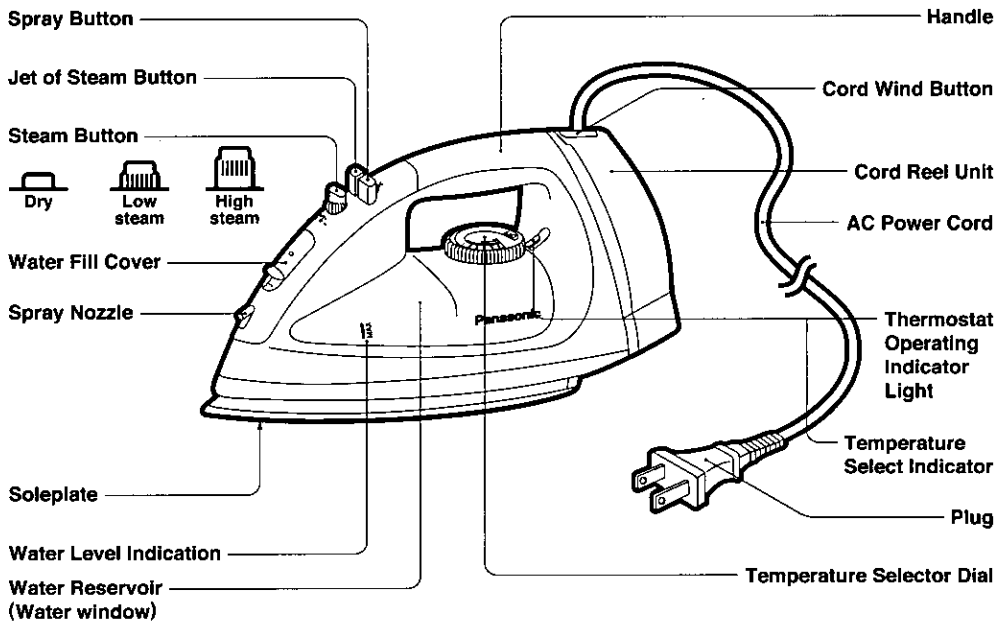

NI-560R

NI-R15NR/R16NR NI-350S

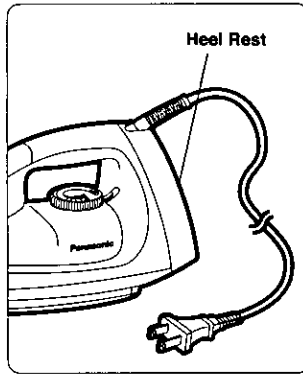
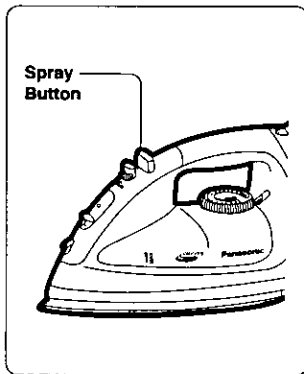
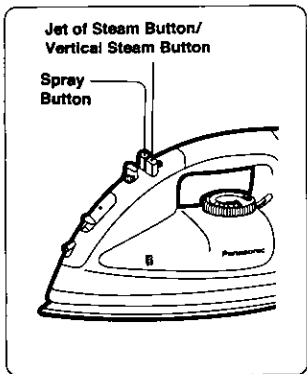

CAUTION DURING USE OF RETRACTIVE POWER CORD (NI-350R/552R/553R/560R/R20NR/R15NR/R16NR Only)

- (1) When retracting power cord, always grasp the plug with one hand while pressing the cord wind button with the other hand.
- (2) If cord does not retract completely, pull it out slightly and wind it again while guiding it into the reel.
- (3) Unwind the power cord in the amount of length you need before plugging it to the wall outlet.
- (4) If the power cord seems hard to unwind due to an improper winding, pull firmly until it is released.
- (5) Do not allow small children to handle the retractive power cord as this may cause the cord to "whip" and cause injury.

GENERAL HINTS BEFORE USING YOUR **Panasonic** IRON

1. Read this instruction book to become familiar with the iron and its features.
2. Most ordinary tap water can be used in this iron. In extremely hard water areas, distilled or demineralized water should be used. Do not use water processed through home water softening systems, because this water contains minerals that may be harmful to the iron.
3. It is best to start ironing garments requiring lower temperature settings first. This will help to avoid damaging garments. If you are not sure of the fabric content, first test the temperature of the iron on an area of a garment where it will not show.

HELPFUL IRONING TIPS

The Temperature Selector Dial of the Panasonic iron has dots on it, in addition to numbers and color indications. This makes it easy to adjust the iron for steam, more or less steam, and any other temperature setting desired. The dots are international fabric protection symbols for various temperature ranges:

- Low Temperature
- Medium Temperature
- High Temperature

Many garments are labeled with these dots as a guide for selecting the proper ironing temperature. For general information about ironing temperatures, refer to the handy fabric guide on the iron. For more specific information, use the "Fabric Ironing Chart" found on page 10.

As a guide to the international Textile Care Labeling code, the following symbols are noted for your information.

INTERNATIONAL TEXTILE CARE & LABELING CODES



Washing



Bleaching



Ironing



Dry Cleaning

A symbol crossed out indicates that the article of clothing must not be subjected to the particular treatment.

EXAMPLE: (DO NOT BLEACH)

Before ironing, sort the garments according to the different heat settings required.
Iron fabrics that need a lower temperature first.
Do not touch plastic buttons with a hot iron because they may melt.
Be careful around zippers and similar items to prevent the soleplate from scratching.

HOW TO FILL

1. Be sure the iron is unplugged from the electrical outlet before filling with water. Push the steam button down, hold the iron, open Water Fill Cover and slowly fill the iron with water (see NOTE) up to "MAX" indication. (about 5.6 ounces / 160ml).
2. Do not overfill. Check the correct water level with the iron in the vertical position.
3. Close the Water Fill Cover.

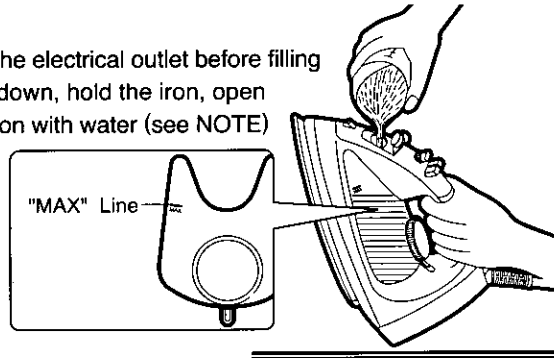

NOTE:

Most ordinary tap water can be used in this iron. In extremely hard water areas, distilled or demineralized water should be used. If distilled water is used, the iron must be seasoned by using tap water for the first four times.

After that, tap water should be used once a month. This is necessary to coat the steam chamber for proper performance.

HOW TO USE AS A STEAM IRON

1. Fill the iron as described in "HOW TO FILL".
2. Set the iron vertically and make sure the Temperature Selector Dial is set to OFF.
Plug the AC cord into the electrical outlet.
3. Set the temperature selector dial to the "☁" or "☁☁" (steam) zone.
"☁" zone: Low steam, for thin or delicate fabrics requiring a small amount of steam.
"☁☁" zone: High steam, for fabrics requiring a lot of steam. (i. e. thick materials, items with stubborn wrinkles.)
4. Preheat the iron until the indicator light goes out, usually about 1-2 minutes.
This light will go on and off during ironing to indicate the temperature chosen by the selector dial is being maintained.
5. Hold the iron horizontally and press the steam button into the steam position.
Steam button is regulated as follows.

NOTE: 3 position steam button.



(Button UP: for High steam. MED: for Low steam)

Temperature Zone	Steam Button Position

Now steam ironing can begin

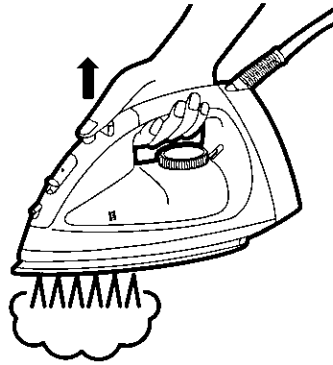

6. Anytime the iron is set vertically the steaming action will stop.

NOTE: Do not use the steam button unless the iron is sufficiently hot enough to produce steam, otherwise water will leak out through the vents instead.

HOW TO USE AS A DRY IRON

1. Press the steam button down to the dry position.
2. Place the iron vertically, set the selector dial to OFF.
3. Plug in the iron.
4. Set the temperature selector dial to the desired position.
(Refer to the Fabric Ironing Chart in this manual on page 10)
5. Preheat the iron until the indicator light goes out, usually about 1-2 minutes.

HOW TO USE THE SPRAY FEATURE

Before using the spray feature, check the garment label for ironing instructions because some fabrics may spot or stain with moisture.

The spray feature is particularly helpful for removing stubborn wrinkles and where extra dampening is needed. The spray may be used with steam or dry ironing.

1. Simply pump the spray button when spray is desired. If the spray doesn't work immediately just keep pumping till it does.
2. To get a finer spray, pump the button vigorously. To get coarser spray, pump the button more slowly. For best results, use a quick, full stroke.

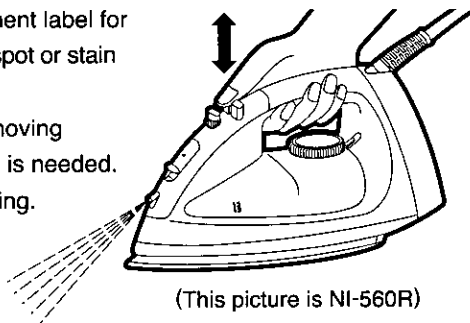

(This picture is NI-560R)

Electronic 3-Way AUTO SHUT-OFF FUNCTION (NI-552R/553R/560R/R20NR/R15NR/R16NR Only)

1. When the iron is left unmoved with its soleplate facing down or on its side for approx. 1. minute, the iron will automatically shut off power to the heater by itself.
2. When the iron is left unmoved on its heel rest for approx. 10 minutes, the iron will automatically shut off power to the heater by itself.
3. To turn the iron back on to resume ironing, simply move the iron in any way. Reheat the iron until the indicator light goes out, if you have left the iron in its auto shut off mode for 10 minutes or more.

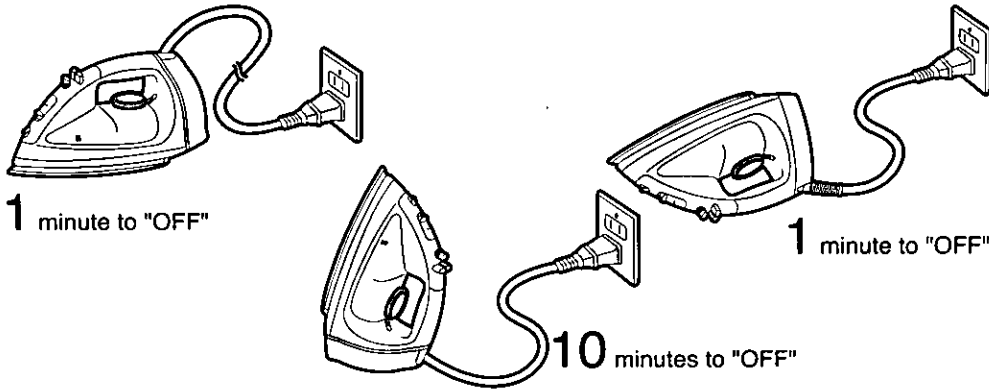

- NOTE: 1. The Auto shut off system works regardless of position of the temperature selector dial, even at "OFF" position.
2. When you finish ironing, always unplug the iron.

※ Licensed under U.S. patent No. 4,686,352 and foreign counterparts.

HOW TO USE THE JET OF STEAM FEATURE

The jet of steam feature gives extra steam which goes deep into the garment and is helpful for removing stubborn wrinkles. The jet of steam feature can be used only in the "☁" indication area of the temperature selector dial when steam or dry ironing (If used at lower setting, water spotting will occur because the iron is not hot enough to change water to steam). If you have not used the "Jet of Steam" feature for a long time, it is necessary to clean the inside of the iron before using this feature on any clothes to be ironed. Simply test the "Jet of Steam" feature several times away from the ironing board and clothes to be ironed. This will prevent brown spotting or water spotting on the clothes.

1. Fill the iron as described in "HOW TO FILL"
2. Set the iron vertically and make sure the temperature selector dial is set to OFF.
Plug the AC cord into the electrical outlet.
3. Set the temperature selector dial to the "☼" indication area.
4. Preheat the iron until the indicator light goes out, usually about 1-2 minutes.
5. Simply pump the jet of steam button when it is desired. But pump the jet of steam button several times before using for the first time at each ironing session.
6. Allow at least 5 seconds between uses of jet of steam to prevent water spotting. Use a press cloth if necessary.

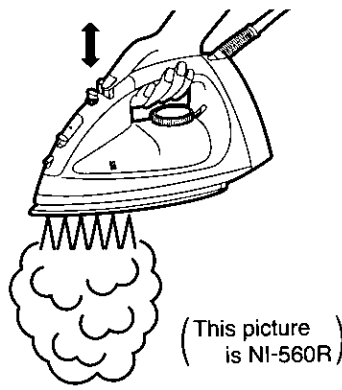

VERTICAL STEAM(NI-560R Only)

To get better results when using vertical Jet of steam, hang the garment on a clothes hanger. Curtain and drapes may also be steamed once they're hung. Hold the iron away from your body close to but not touching the fabric. Pull the fabric tight with your free hand and pump the Vertical steam button (Jet of Steam Button) at 5-second intervals as you pass the iron over the wrinkled fabric.

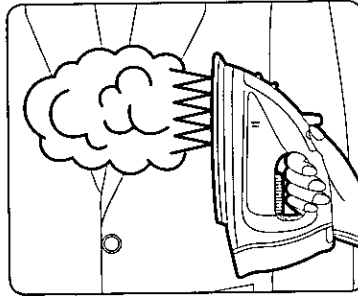

WARNING:

Never iron clothes on the body or point your iron at anyone when steaming.
Keep hands and body away from steam areas while using vertical steam feature.

SELF-CLEANING

With the self-cleaning feature you can flush out mineral residues from the steam generating chamber and the steam vents...refreshing your iron each time for a longer steaming life. It is very important to operate the self-cleaning feature after each steam ironing to prevent mineral accumulations from hardening.

1. Check water level. Water level should be at the 1/2 full. When water level is below 1/2 full, fill with water according to the instructions in "How to Fill".
2. Preheat at "6" setting. (in about 1-2 minutes)
Make sure that the steam button is in the Dry position.
3. Set the dial to off and remove the AC plug.
4. Hold the iron horizontally over the sink.
5. Pump the "Jet of Steam" button quickly (at least 3 times per second) about 20-30 times.
6. While self-cleaning, pitch the iron up and down slowly to help clean the entire inside and let the water drip out of the sole plate vents.

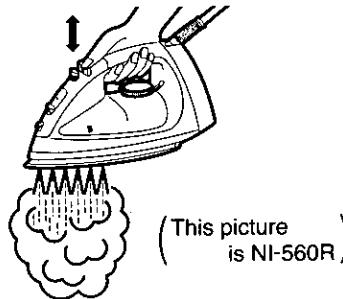

7. Check that all water and steam thoroughly stop coming out of the sole plate vents.
After self-cleaning is finished dump any remaining water out of the iron.
8. Iron on a towel to remove any drops of water remaining on the bottom of iron.
9. Cool as usual and store the iron on its heel rest. Never store an iron on its soleplate or with water in it.

NOTE:

If water still remains inside the sole plate after self-cleaning operation, then dry out the iron by vaporizing the remaining water setting the iron on the "6" setting. And follow the instructions under "AFTER EACH USE".

HOW TO CARE FOR YOUR IRON

AFTER EACH USE

1. Turn iron off and unplug.
2. Empty iron immediately after using. Don't store the iron with water in it.
3. Depress the steam button down into the dry position.
4. Wait until the iron has cooled before storing it, and always set it on the heel rest to protect the soleplate from scratching, corroding or staining.
5. After letting iron cool completely, push the cord wind button to wind the cord. Store iron vertically in a safe place after winding cord completely.
(NI-350R/530R/552R/553R/560R/R20NR/R15NR/R16NR Only)

MAIN BODY

After unplugging and cooling the iron, simply wipe off with a damp cloth and if necessary, use a mild detergent.

NEVER USE ANY HARSH CLEANERS.

SOLEPLATE

Starch and other residue may be easily removed from the soleplate with a damp cloth.

To avoid scratching the finish never use a metallic pad to clean the soleplate, and never place the iron on a rough surface.

If synthetics are ironed at too high a temperature, not only is the fabric usually ruined, but the iron soleplate is often covered with the melted remains of the synthetic fabric.

The best way to remove synthetic residue from the soleplate is to heat the iron and to iron over an old cotton rag.

CAUTION:

Never use steam iron cleaners in the iron, since they may damage the inside of the iron.

FABRIC IRONING CHART

- NOTES: 1. Check garment for specific ironing instructions. Always follow manufacturer's instructions.
 2. Iron blended fabrics at setting for lower-temperature fiber or for the highest-percentage fiber.
 3. Use caution, some synthetics may melt at high temperature.

Temperature Selector Setting	Fabric	Ironing Recommendations
1	ACRYLIC *ACRILAN *CRESLAN *ORLON ACETATE METALLICS SUEDE	Dry iron on wrong side, or use a press cloth on top of fabric. Don't sprinkle water directly on fabric to avoid spots. To iron suede, cover ironing board with brown paper and use it as a press cloth.
2	NYLON *ANTORON *CAPROLAN SILK	Dry iron on wrong side.
3	PERM. PRESS RAYONS POLYESTER *DACRON *FORTREL *KODEL TRIACETATE *ARNEL W'n W COTTON	Dry iron on wrong side. To touch-up collars, cuffs, pockets, etc., iron lightly on right side.
4	WOOL VELVET	Steam ironing is suggested. Never iron completely dry. To iron velvet, steam iron holding the slightly above the fabric.
5	COTTON	Steam ironing is suggested. Sprinkle water on the fabric, depending on its thickness. Iron dark fabrics on wrong side to avoid unwanted sheen.
6	LINEN	Steam ironing is suggested. Iron dark fabrics on wrong side to avoid unwanted sheen.

*Trademarks of Fiber Manufacturers.

Panasonic Consumer Electronics Company, Division of Matsushita Electric Corporation of America
 One Panasonic Way Secaucus
 New Jersey 07094

Panasonic Sales Company, Division of Matsushita Electric of Puerto Rico, Inc. ("PSC")
 Ave. 65 de Infanteria. Km. 9.5
 San Gabriel Industrial Park, Carolina,
 Puerto Rico 00985