

This Owner's Manual is provided and hosted by [Appliance Factory Parts](#).



TURBO AIR TAS09VH Owner's Manual

[Shop genuine replacement parts for TURBO AIR
TAS09VH](#)

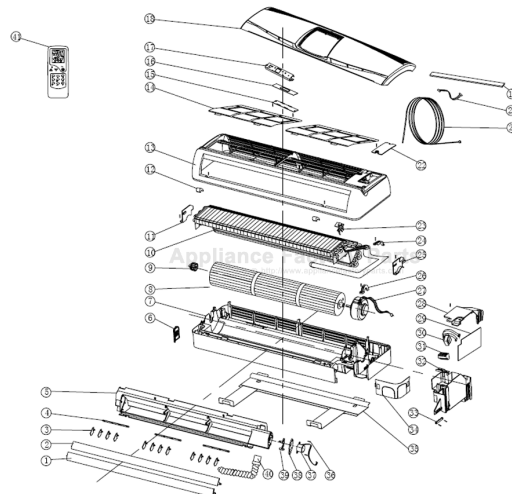

Figure 2-2

[Find Your TURBO AIR Air Conditioner Parts - Select From 72 Models](#)

----- Manual continues below -----

Foreword

Air conditioners are units that should have the professional technicians do the installation for you. This Instruction Manual is the universal-purpose version for the models of split wall-mounted air conditioners manufactured by our Co. The appearance of the units that you purchase might be slightly different from the ones described in the Manual, but it does not affect your proper operations and usage. Please read carefully the sections corresponding to the specific model you choose, and keep the Manual properly so as to facilitate your reference at later time.

Addition to the user manual:

The appliance is not intended for use by young children or infirm persons without supervision; Young children should be supervised to ensure that they do not play with the appliance.

Contents

Instructions to users	1
The name of each part and its function	3
Operation and indication sections of remote controller	5
Use of remote controller	6
Features of heating operations	9
Methods of maintenance	10
Treatment at service call	11
We hope you will know the following when using the unit	12
Installation of electric components	13

Please read the "Instruction Manual" carefully prior to the use of your air conditioner so as to ensure proper operations.

Instructions for Installation

- Make sure to have the professional after-sale service persons of our company or the authorized dealers to install the units before you use.

1. The units are not to be installed at places where there might be leakage of combustible gases.

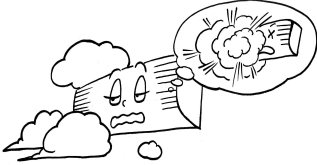

In case that the leaked gas accumulates around the units, there might occur the accident of fire hazards.

Make sure that the earth leakage-circuit breaker is installed.

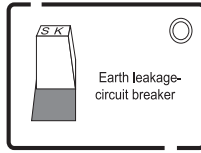

Absence of the earth leakage-circuit breaker might lead to electric shock and some other hazards.

After the connecting of the wires between the indoor unit and the outdoor unit, check whether the connecting is loose or not by pulling the wire with a little force.

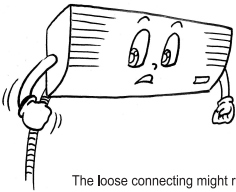

The loose connecting might result in fire hazard.

Make sure that the air conditioner is properly grounded.

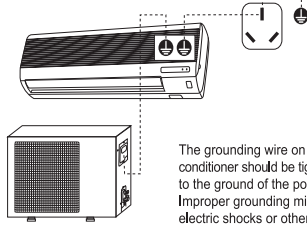

The grounding wire on the air conditioner should be tightly connected to the ground of the power source. Improper grounding might cause electric shocks or other hazards.

Instructions for Operation

Never try to stop the operation of the air conditioner by operate the switch.

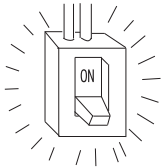

Such performance might cause electric shocks or fire hazards.

Do not press, stretch, damage, heat or modify the power line.

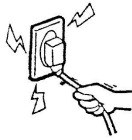

It might cause electric shocks, overheating, fire hazards, etc. If the power line wire is damaged or needs to be replaced due to some other reasons, please make sure to have dealer or the authorized maintenance people to do the replacement.

Do not operate the switch by wet hands.

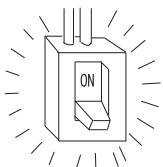





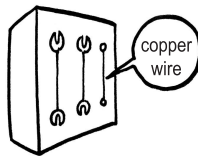



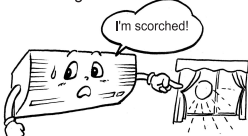

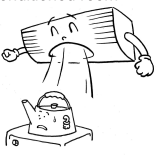

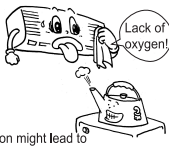

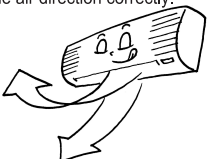
It might cause electric shocks.

Never use the fuse with incorrect capacity or any other metal wires.



The use of metal or copper wires for fuse might cause operational failures or fire hazards.

<p>Try to avoid the sunlight and hot air from entering the room.</p>  <p>During the cooling operation, curtains or window-blinds should be used to shade off the sunlight.</p>	<p>Try to minimize the generation of heat during the operation of cooling.</p>  <p>Place the heating sources out of the room.</p>	<p>Do not use combusting apparatuses in the air-conditioned room.</p>  <p>It might lead to the incomplete combustion of these apparatuses.</p>
<p>Do not place insecticides or paints and other flammable sprays near the air conditioner, or spray them directly at the air conditioner.</p>  <p>It might cause fire hazards.</p>	<p>When it is necessary to use the air conditioner and the combusting apparatuses in the same room, air ventilation has to be made from time to time.</p>  <p>Insufficient ventilation might lead to lack of oxygen or some other dangers.</p>	<p>Prior to the maintenance of the air conditioner, please cut off the power supply first. Never do the cleaning of the units when the fan is in high-speed operations.</p> 
<p>Do not insert sticks or bars into the air vents.</p>  <p>As the fan is in high-speed operation, the insertion might lead to accidents.</p>	<p>Adjust the air direction correctly.</p>  <p>Properly adjust the up/down and left/right directions of the air flow so as to get the even room temperature.</p>	<p>Do not keep exposed to the cool air for long time.</p>  <p>It might cause discomforts of the body, which is harmful to your health.</p>
<p>Do not clean the air conditioner with water.</p>  <p>It might cause electric shocks.</p>	<p>Do not attach, hang or stack articles on the air conditioner.</p>  <p>It might lead to the falling down of the air conditioner unit, which will result in accidents or injuries.</p>	<p>Check the supporting structures of the units carefully.</p>  <p>In case of damages, the supporting structures should be immediately repaired so as to avoid falling down of the unit, which might cause human injuries or other accidents.</p>
<p>Do not sit on the outdoor unit or place any other objects on it.</p>  <p>The falling down of the unit or the objects might cause human injuries and other accidents.</p>	<p>Do not use the following substances:</p>  <p>Hot water (over 104°F or 40°C) The use of hot water will deform the air conditioner or make it fade in color. Gasoline, paint diluent, benzene and polishing agents, etc. These substances will deform the air conditioner or cause scratches.</p>	<p>Put down the power when the unit is not in use for long time so as to ensure safety.</p>  <p>When the plug is to be pulled out, make sure that the switch of the air conditioner is turned off.</p>

Instructions for Removal and Repair

- When removal or repair is needed, please contact the dealer or authorized maintenance & installation people.
- In case of any abnormal occurrences (smell of burning), please stop the operation at once, cut off the power supply and contact the dealer or authorized maintenance people.

【The name of each part and its function】

There are many models, features and appearance will vary, all the figures provide a demonstration to introduce the function.

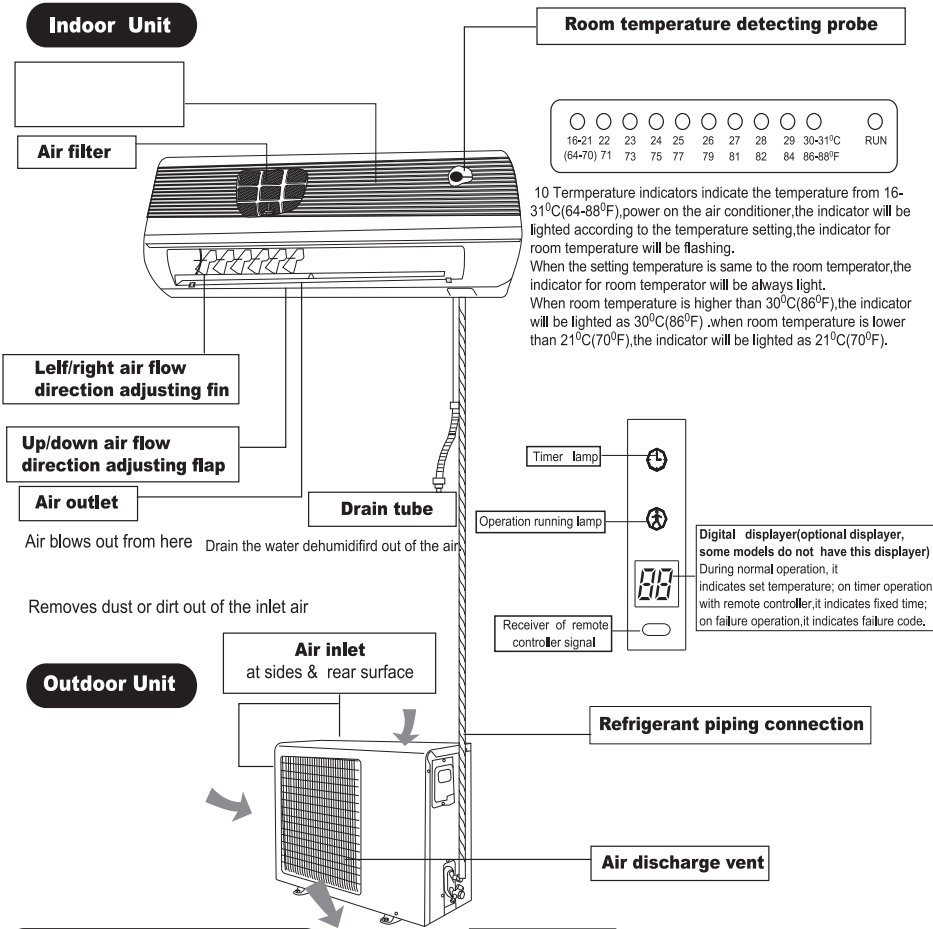

Unit operation section

How to open

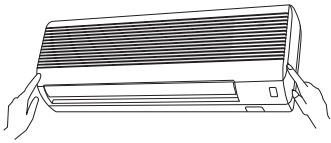

Lightly push both sides of the air inlet grid at the bottom and pull it to this side till a resistance is felt.

How to close

Push down the air inlet grid and the push both sides of air inlet grid at the bottom.

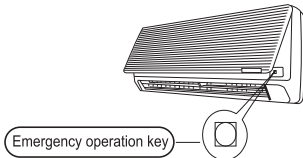

This button can be used as an emergency measure to turn on/off unit when remote controller is not available.

● Note: Do not open the grid at an angle over 60 degrees. Do not operate the units with too much force.

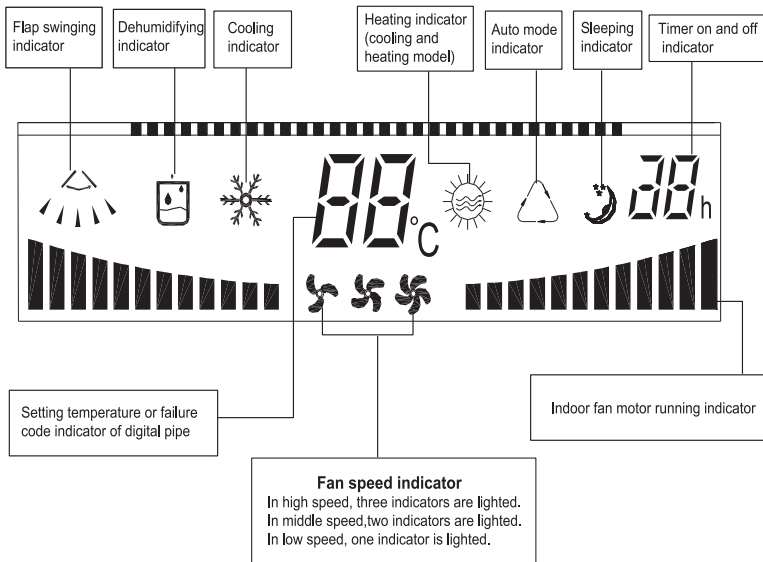
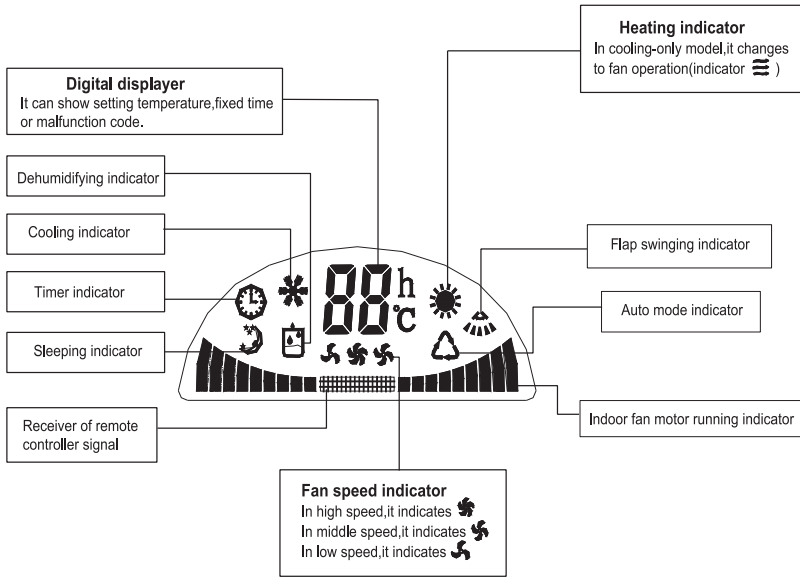

Note: The indicator may be changed, but it does not affect your operation, please subject to what you purchase.

AUTO MODE OPERATION PROCEDURE

Operates by selecting automatically the operation mode (DRY, COOL, or HEAT) depending on the room temperature at starting.
With the remote controller pointing the air conditioner.



1 Press the ON/OFF button.

When the unit is not at AUTO SELECT mode.

2 Press the MODE button. Set to "AUTO SELECT"

Each time the button is pressed ,the operation mode is changed in sequence ,from "AUTO", (COOL), (DRY) to (HEAT)/(FAN)

When the "AUTO" is displayed,the air conditioner is automatically controlled at the optimum temperature

TO Stop: Press the ON/OFF button.

The operation of the AUTO SELECT mode can be performed by only pressing the ON/OFF button from the next time.



If you don't like the content of AUTO SELECT mode operation.
Change to HEAT DRY or COOL than AUTO SELECT.

CAUTION: restarting the unit must wait 3 minutes

Temperature adjusting procedure during AUTO SELECT operation

Adjusts air temperature during AUTO SELECT operation , press "▲" button or "▼" button, adjusts temperature.

Press "▲" one time ,the temperature raises about 1°F (or 1°C).

Press "▼" one time ,the temperature reduces about 1°F (or 1°C).

Cool/Heat(Fan)/Dry mode Operation Procedure

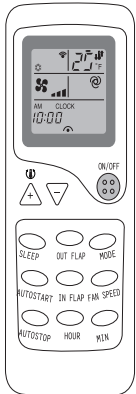

●In the Cooling -only model, the HEAT Mode will cancel,and it will be replaced by FAN mode

With the remote controller pointing toward the air conditioner.

1 Press the ON/OFF button .

2 Press the MODE select button
Select the operation mode .
(COOL, DRY, HEAT/FAN,AUTO)

3 Press ▲ or ▼ button .
Set to your favorite temperature press▲ or ▼ button

HEAT	COOL
64°F-88°F(or 16°C-31°C)	64°F-88°F(or 16°C-31°C)

If CONT- is selected , room temperature isn't controlled , operation being continuously.

4 Press the FAN SPEED button .
Set to your favorite air flow rate.

To stop : Press the ON /OFF button .

Changing procedure of the content of the operation
Set to the content.
The content of the operation can be set or changed even while the air conditioner is off operation .

Air flow direction adjustment procedure

Adjusting up/down air flow direction

Up/down direction can be adjusted by using the OUT FLAP button on the remote controller. This button , each time pressed , changes the mode in the following sequence:



Change to the OUT FLAP mode.

TO change the VANE CONTROL velocity press the FAN SPEED button.

Each time the button is pressed, fan speed is changed in sequence, from [Lo] [Mid] [Hi] [AUTO].

To cool the whole room ,use the [Hi] mode , (COOL MODE) . If the sound of the air conditioner operating disturbs your sleep ,use the SLEEP mode .

Recommended horizontal VANE range.

Use in the (AUTO) position usually.

Use positions (1) or (2) in the COOL or DRY mode and positions

(3) to (5) in the HEAT mode when adjusting to your requirements.

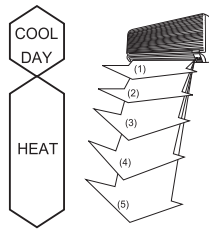

NOTE

- In the cooling operation ,when the air conditioner is operated with OUT FLAP blowing down (4) or (5) for 1 hour , the OUT FLAP direction is automatically set to level to prevent condensed water from dropping.
- Adjust the vertical OUT FLAP direction using the remote controller .If the horizontal vane are moved manually, it may cause trouble.
- In heating operation , if the output air temperature is too low or when defrosting is done ,the horizontal vane position is set to (1).

Adjusting left/right air flow direction

Horizontal & vertical auto swing.

Adjust the direction by remote controller.Press the IN FLAP button,the air swinging fins will constantly make the left/right swinging or fixed direction in air delivery.

PRESENT TIME SETTING PROCEDURE

When cells are inserted, the present is automatically set to AM 12:00. EX.:Set to AM 10:30

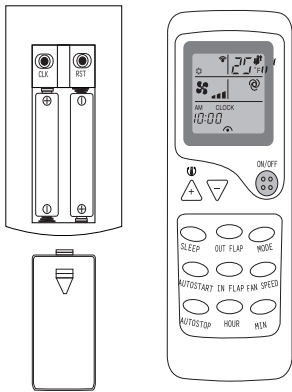

- 1 Press the CLK button.**
Unload the back cover push the clock button with the tip of a ball pen, etc. The time indicator is flickering and can set the present time.
- 2 Press the HOUR button. (Set to AM 10:)**
- 3 Press the MIN button. (Set to 30)**
- 4 Press the CLK button again, then reattach the back cover**

NOTE The timer is set on the basis of the present time. So set the present time correctly.

SLEEP OPERATION PROCEDURE

Use this mode to reduce operation sound when sleeping, etc.

Press the SLEEP button, the air flow sound from the indoor unit is decreased.

Press the SLEEP button again can release the mode.

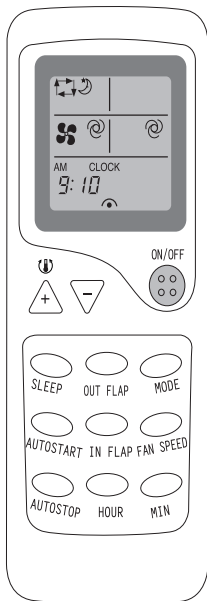

NOTE:

- 1** Use the sleep mode when you are going to bed. If this mode is used in the day, the capacity is reduced since the ambient temperature is too high. (COOL MODE).
- 2** During the operation of cooling, the room temperature will be raised higher than the setting after the machine begins to operate in the sleeping mode.
- 3** During the operation of heating mode, the room temperature will be dropped lower than the setting after the machine begins to operate in the sleeping mode.

It is convenient to set the timer for the time when you go to bed ,when you get home ,when you get up , ect.

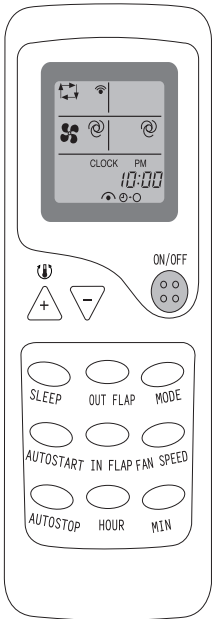

How to set the ON timer

1 Press the AUTO START button to set the on timer mode when the AC is in the standby mode.

Each time the button is pressed, the ON timer mode alternates between ON and OFF.

2 Set the time of the timer using the HOUR and MIN buttons.

Each time the HOUR button is pressed , the Set time is counted up by 1 hour; each time the "MIN" button is pressed, the set time is counted by 10 minutes.

● To release the ON timer:

Press the AUTO START button to release the timer.

HOW to set the OFF timer

1 Press the AUTO STOP button to set the OFF timer mode during operation.

Each time the button is pressed, the OFF timer mode alternates between ON and OFF.

2 set the time of the timer using the HOUR and MIN buttons.

Each time the HOUR button is pressed , the Set time is counted up by 1 hour; each time the "MIN" button is pressed, the set time is counted by 10 minutes.

● TO release the OFF timer:

Press the AUTO STOP button to release the timer.

Programming timer operation

The ON timer and OFF timer can be used in combination .The time of the set time which is reached first will operate first (↔ mark indicates the order of timer operations.)

● If the current time has not been set ,the timer operation cannot be done.

【Features of Heating Operations】

Basic principles and performances

- The machines absorb heat from the outdoor air and transfer it indoors so as to heat the room air. The heating capabilities through this principle of heat pump go up/down with the increase/decrease of the temperatures of the outdoor air.
- It only needs a fairly short time for such hot air circulation system to raise the room temperature.
- When the outdoor air temperature is very low, the system can be used together with other heating devices. But good ventilation should be maintained to ensure safety and prevent accidents.

Defrosting

When the outdoor air temperature is very low and humidity is very high, frosting will occur to the heat exchanger of the outdoor unit, which has negative impacts upon the efficiency of the heating performance. In such case, the automatic defrosting function will come into play. The heating operation will be stopped for 5-10 minutes to do the defrosting.

- During the defrosting, the outdoor unit might generate some steam. It is caused by fast defrosting, which is not a performance failure.
- Upon the completion of the defrosting process, the heating operation is resumed.

The air conditioner must be turned off power before the maintenance is to be carried out.

Before the season of operation

- 1** Check if there are any blocking materials in the intake and outlet vents of the indoor and outdoor units.

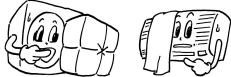

- 2** Check if the installation stand is corroded or rusty.

- 3** Check if the machine is properly grounded.



- 4** Check if the air filter is clean.

- 5** Connect to the power source.

- 6** Put batteries in the remote controller.

During the season of operation

The cleaning of the air filter screen (Standard intervals should be once every two weeks).

- 1** Remove the air filter screen from the unit.

- Gently press the two lower ends of the grid and open it.
- Gently pull up the air filter screen and take it out in the direction of your body.



- 2** Clean the air filter screen.

if the screen is very dirty, please use lukewarm water (about 86°F or 30°C) to clean it. Air it dry after the cleaning.

Note:

- Do not use boiling water to clean the screen.
- Do not bake the screen dry over a fire.
- Do not exert too much force in pulling and stretching the screen.

- 3** Install the air filter screen.

To operate the air conditioner without the air filter screen on will cause the interior of the machine dirty which might lead to poor performances or damages to the units.

Clean the air conditioner

- Use a soft and dry cloth to rub the air conditioner, or use a vacuum cleaner to clean it.
- If the air conditioner is very dirty, use a piece of cloth and soak it with neutral home-use detergent to do the cleaning.

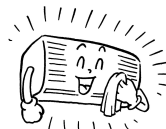

After the season of operation

- 1** Set the temperature at 86°F or 30°C and operate in the fan status for about half a day.



To make the interior of the units dry

- 2** Stop the operation of the machine and turn off the power switch.

The air conditioner will consume about 5W of electric power after the machine is turned off. For the purpose of energy saving and safety, it is advisable to pull the plug out during the non-operational seasons.



- 3** Clean and install the air filter screen.

- 4** Clean the indoor and outdoor units.



- 5** Take the batteries out from the remote controller.

Note:

If the air filter screen is blocked by dust or dirt, the performance of cooling and heating will be affected, with the operation noise and power consumption increased. Therefore, the air filter screen should be cleaned regularly.

Please check the following before requesting after-sale service from your dealer .

The air conditioner does not operate at all .

Is the power in an outlet ?	Is the time set to "ON" position ? 	Is there a power failure or a break fuse ?
-----------------------------	--	--

Room temperature can't be controlled .
(Too cold or too hot)

Is the room temperature setting too low or too high?

Poor cooling or heating performance .

Is the room temperature setting suitable ? suitable TEMP 	Are the air filters clean (Not clogged)? 	Are the window (s) and door (s) opened ?
---	--	--

Poor cooling performance .

Is direct sunlight entering the room ? 	Is there a heat source in the room ? 	Are there too many people in the room ?
--	--	---



If the air conditioner does not operate properly ever after conducting the above checks , when the doubt still remains even after consulting page 11 or in case that such phenomena as those shown below, turn off the power and contact your distributor .

Cases requiring immediate contact with the distributor

Pull out the power plug immediately and inform to your distributor in the following situations:

<p>Fuse or breaker often breaks off</p>	<p>Malfunction is observed TV , radio or other devices .</p>
<p>Switch dose not actuate surely</p>	<p>Abnormal noise is heard during operation</p>
<p>When faulty operation movement is observed when the RUN button is pressed , even after restarting the operation after 3 minutes , faulty movement does not disappear .</p>	

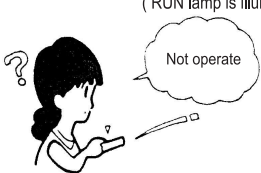
[We hope you will know the following when using the unit]

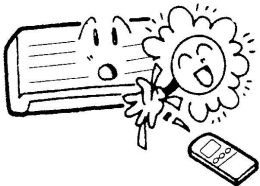
<p>The unit can not be restarted just after shut down . (RUN lamp is illuminating)</p> 	<p>Restart is stopped for 3 minutes after shut down to protect the unit .</p>  <p>Three-minute protection timer incorporated in the microcomputer actuates automatically . Except that power is connected , this function does not actuate .</p>
<p>Air is not blown out at starting of heating operation .</p>	<p>Air blow is stopped to prevent blowing out of cold air until the indoor heat exchanger is warmed . (2 to 5 min) (HOT KEEP)</p>
<p>Air is not blown out for 6 to 12 min , at heating operation .</p>	<p>When outdoor temperature is low and humidity is high , the unit sometimes performs defrosting automatically . Please wait . During defrosting , water or steam are raising from the outdoor unit .</p>
<p>Air is not blown out at DRY operation .</p>	<p>Indoor fan is sometimes stopped to prevent vapor of dehumidified moisture and save energy .</p>
<p>Mist is blown out at COOL operation .</p>	<p>This phenomenon sometimes occurs when the temperature and humidity of the room are very high , but it will disappear with the lowering of the temperature and humidity .</p>
<p>Odor is sent out .</p>	<p>Air blown out during operation may smell . This is the smell of tobacco or cosmetics stuck to the unit .</p>
<p>Noise is heard cracking sound .</p> 	<p>This is caused by the refrigerant that is circulating inside the unit.</p>
<p>Noise is heard cracking sound .After a power stoppage or after disconnecting the power supply plug.</p>	<p>This is caused by heat expansion or contraction of plastics.</p>
<p>Operation can not be restarted even if the power is recovered.</p>	<p>The memory circuit of the microcomputer is cleared . Operate the remote controller again to restart the operation .</p>
<p>Remote control signals are not received .</p>	<p>Remote control signals may not be received when signal receiver on the air conditioner body is exposed to direct sunlight or strong lighting . In that case , interrupt the sunlight or darken the lighting.</p> 
<p>Moisture may form on the air outlet grilles .</p>	<p>If the unit is operated for a long period of time with the high humidity , moisture may form on the air outlet grilles and drip down .</p>

Points of attention

- HACR type breaker should be utilized along with proper installation;
- Make sure of the applicable voltage and cables or wires for the specific model to be used, before doing the connections;
- Read the prompts at the terminal board for wiring. Make sure the wiring is done correctly.
- Pay attention to the poles of the signal terminal and connect the terminals to match the identification numbers.
- When the wiring connections are wrong, the compressor will not work.
- The connecting wires are not supplied.
- The provision for connection of one of the wiring systems that in accordance with the National Electric Code shall be had. ANSI/NFPA 70-1990 would be acceptable for it.
- The connecting wires specification is 14 AWG, VW-1 (or THHW), copper core and 105°C (or 221°F). Their set screw diameter is 4 mm. The power source is 240V, 60Hz and 1 phase. Minimum circuit ampacity of the wiring systems is 20A.

Connection of wires for outdoor unit and indoor unit

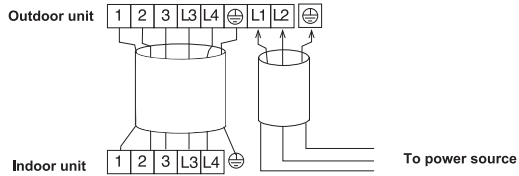

Note:

- The environment conditions must be taken into consideration when the connections of power cable are made (such as the ambient temperature, direct exposure to heat/direct exposure to sunlight);
- The specifications for the power cable refer to the minimum values of the metal core wires. Taking into consideration the voltage losses, the core wire of power cable must be one size larger than the specifications;
- The grounding wire must be connected to the indoor units and outdoor units;
- The laying of power cables must be done by qualified electricians and comply with the regulations of the local power supply authorities and with the standards of the electric appliances;