

This Owner's Manual is provided and hosted by [Appliance Factory Parts](#).

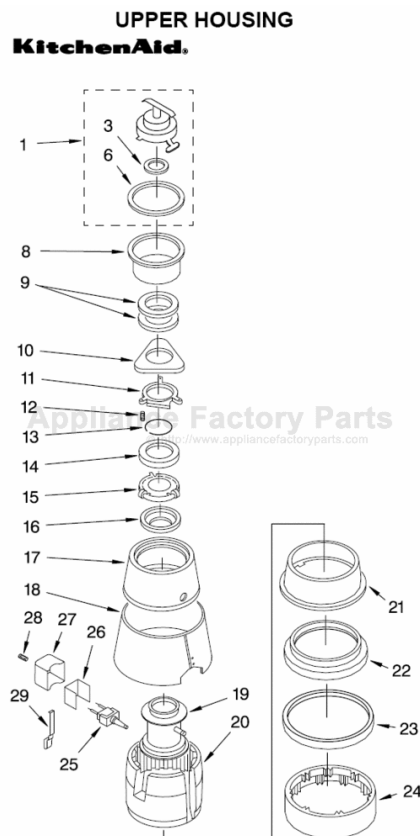

KITCHENAID 4KBDS250T1 Owner's Manual

[Shop genuine replacement parts for KITCHENAID
4KBDS250T1](#)



[Find Your KITCHENAID Disposal Parts - Select From 75 Models](#)

----- Manual continues below -----

KitchenAid®

Food-Waste Disposer

Installation Instructions

Proper installation is your responsibility. Read instructions carefully before beginning installation. Make sure you have everything necessary for correct installation.

Tools and materials needed for installation:

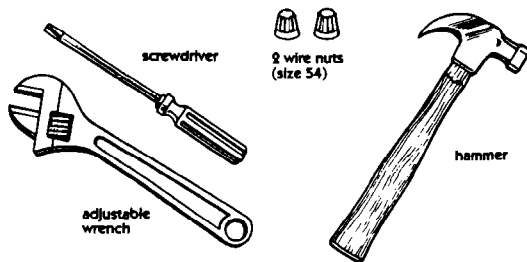

Optional tools and materials needed for some installations:

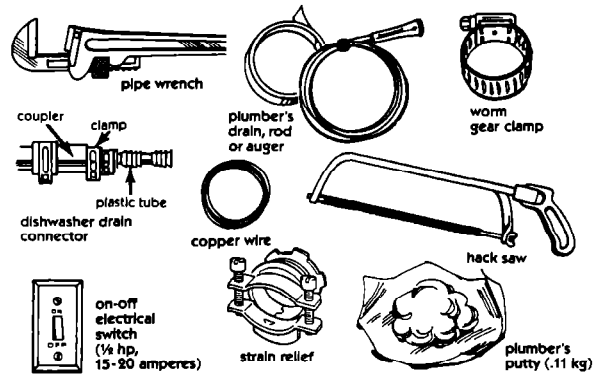

Ask about the KitchenAid® Instant Hot® water dispenser – the faucet that cooks as it pours.

• Delivers 190°F (87.8°C) hot water – perfect for soups, cereals, sauces, gravies, desserts and more!

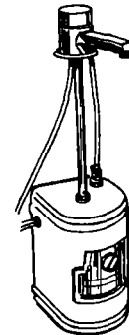

Instructions pertaining to risk of fire, electric shock, or injury to persons.

Important safety instructions:

WARNING: When using electric appliances, basic precautions should always be followed, including the following:

1. Read all the instructions before using the appliance.
2. To reduce the risk of injury, close supervision is necessary when appliance is used near children.
3. Do not put fingers or hands into waste disposer.
4. Turn the power switch to the OFF position before attempting to clear a jam or remove an object from the disposer.
5. When attempting to loosen a jam in a waste disposer, use a self service jam-breaker wrench as described in Use and Care Guide.
6. When attempting to remove objects from a waste disposer, use long-handled tongs or pliers.

7. To reduce the risk of injury by materials that may be expelled by a food-waste disposer, place the stopper in the drain/grind position when grinding. Do not put the following into a disposer:

- a. Clam and oyster shells.
 - b. Drain cleaner.
 - c. Glass, china or plastic.
 - d. Large, whole bones.
 - e. Metal, such as bottle caps, tin cans, or aluminum foil.
8. When not operating a disposer, leave the drain cover in place to reduce the risk of objects falling into the disposer.
9. a. **GROUNDING INSTRUCTIONS FOR CORD-CONNECTED UNITS.** This appliance must be grounded. In the event of a malfunction or breakdown, grounding provides a path of least resistance for electric current to reduce the risk of electric shock. If this appliance is equipped with a cord having an equipment-grounding conductor and a grounding plug, the plug must be plugged into an appropriate outlet that is properly installed and grounded in accordance with all local codes and ordinances.

DANGER – Improper connection of the equipment-grounding conductor can result in a risk of electric shock. Check with a qualified electrician or serviceman if you are in doubt as to whether the appliance is properly grounded. Do not modify the plug provided with the appliance - if it will not fit the outlet, have a proper outlet installed by a qualified electrician.

- b. **GROUNDING INSTRUCTIONS FOR PERMANENTLY CONNECTED UNITS:** This appliance must be connected to a grounded, metal, permanent wiring system; or an equipment-grounding conductor must be run with the circuit conductors and connected to the equipment-grounding terminal or lead on the appliance.

Save these instructions.

INSTALLER – Please leave Installation Instructions with the homeowner or occupant.

For service information, call your local KitchenAid Distributor.

Start the installation

Installation dimensions

Food Waste Disposer Dimensions in Millimeters.

MODEL No.	A	B*	C*	D	E
4KCDB150	289	151	102	160	127
4KCDB250	321	151	102	160	127
4KCDQ250	324	175	102	197	146
4KCDI250	341	173	102	230	146
4KCD5250	348	173	102	256	181
4KBD5250	408	240	102	256	181

B* – Distance from bottom of sink to center line of disposer outlet. Add 12.7 mm when stainless steel sink is used.

C* – Length of waste line pipe from center line of disposer outlet to end of waste line pipe.

IMPORTANT: Plumb waste line to prevent standing water in the disposer motor housing.

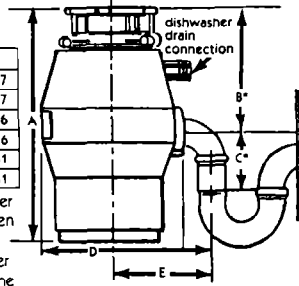

Drawing shows just one model type.

1 Check that all parts were included.

Drawing shows just one model type.

Mounting assembly

sink flange

2 rubber gaskets

back-up ring

mounting ring and 3 screws

snap ring

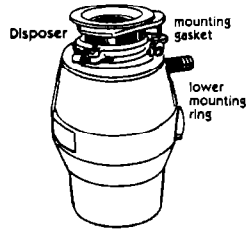
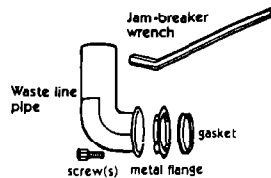
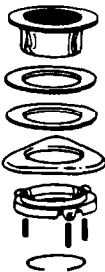

2 Electrical supply

Before attempting to install electrical supply to your disposer, you must be very familiar with electrical power and proper procedures. If you are not, contact a qualified electrician. This appliance is equipped with copper wires. Use 3-conductor copper cable in accordance with the local code to make connections to the unit.

- A.** Remove the fuse or turn the circuit breaker to the "off" position for the circuit you plan to use for your disposer. Use a separate 20-ampere, 115-volt, 60 Hz only circuit for the disposer.

If you are replacing an old disposer, go to Step 3.

For a first time installation, connect 15- or 20-amp, 115-Volt cable from junction box to switch.

- B.** For continuous feed models: Install a 15- or 20-amp wall switch above the countertop and junction box inside cabinet as shown. (1/2-hp switch and electrical wiring can be obtained locally.) Position switch in a convenient location. Connect switch to junction box. **All wiring must comply with local codes and ordinances.** No. 14-gauge wire is the smallest size wire allowable for use with a 15-amp circuit. No. 12-gauge wire is the smallest allowable for use with a 20-amp circuit. Go to Step 4.

The disposer can be installed using a power supply cord with a 3-prong grounding plug. This type of power supply cord is available from local sources.

WARNING: Improper connection of the equipment-grounding conductor can result in risk of electrical shock. Check with a qualified electrician or appliance technician if you are in doubt as to whether the appliance is properly grounded.

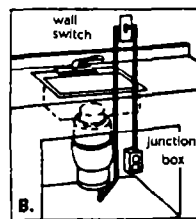
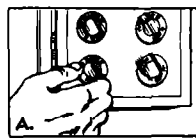

3 Remove old disposer.

WARNING: Potential Electrical Shock Hazard
TURN OFF ELECTRICAL POWER at the service panel (fuse box or circuit breaker box).

Compare your new disposer mounting assembly with the existing mounting. If the mounting assemblies are the same, complete Steps 3-A, B, D, E.

- A.** Using a pipe wrench, disconnect the drain line where it attaches to the disposer waste line pipe.

- B.** If old disposer mounting is the same as your new one, insert end of jam-breaker wrench or screwdriver into right side of a disposer mounting ring lug at top of disposer. Hold disposer with other hand. Turn jam-breaker wrench or screwdriver counterclockwise until lug lines up with one of the sink-mounting assembly screws.

CAUTION: Hold disposer with one hand while turning to prevent it from falling when the mounting ring is disconnected. Remove disposer. Go to Step 3-D.

- C.** If old disposer mounting is different from your new one, remove the nuts on the mounting ring using pliers or an adjustable wrench. Remove old disposer. You may need to remove a clamp or twist the disposer to remove it.

- D.** Turn disposer upside down and remove the electrical plate.

- E.** Use a screwdriver to remove the grounding wire. Remove wire nuts from power wires. Separate disposer power wires from the cable wires. Loosen screw(s) on strain relief and remove cable from the disposer.

If old disposer mounting is the same as your new disposer mounting, go to Step 5.

- F.** Loosen screws and remove the mounting ring and back-up rings. A hammer may be needed to loosen rings.

- G.** Push old sink sleeve up through the sink hole and remove.

- H.** Clean sealant from sink hole rim using a screwdriver or putty knife to scrape away all traces of putty or caulking from the sink hole rim. Hole rim must be as clean as possible for a good, watertight seal.

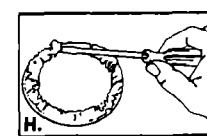
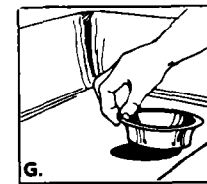
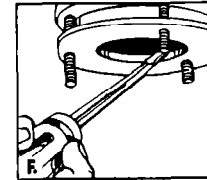
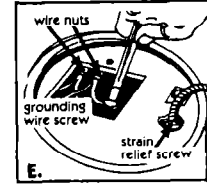
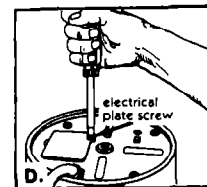
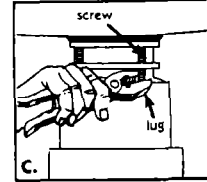
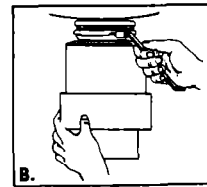
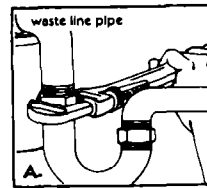

4 To install your sink's first disposer:

- A.** Use wrench to loosen nut at top of "P"-trap.

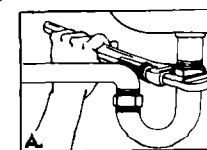

B. Remove nut at top of sink strainer. Remove extension pipe.

C. Loosen the large-diameter nut at the base of the strainer by placing the tip of a screwdriver on the ridge of the nut and gently tapping the screwdriver with a hammer.

D. Remove nut

E. Push the strainer assembly up through the sink hole and remove.

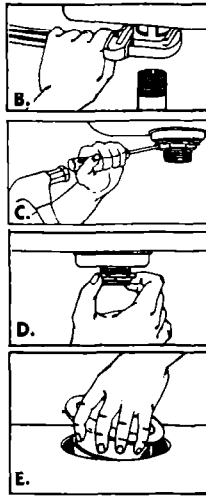

5 Clean sink's drain line.

If installing in a new home, go to Step 6. Remove drain trap. Using an auger, clean out the horizontal drain pipe that runs from the trap to the main waste pipe. Watch these trouble spots when routing the auger.

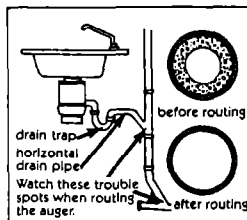

6 Separate the mounting assembly.

A. Holding the mounting assembly with one hand, use the other hand to insert jam-breaker wrench into one of the lugs of the lower mounting ring. Turn assembly counterclockwise and remove.

B. Loosen screws on mounting assembly until they are level with mounting ring surface.

C. Use screwdriver to pry off snap ring.

D. Take assembly apart and set aside.

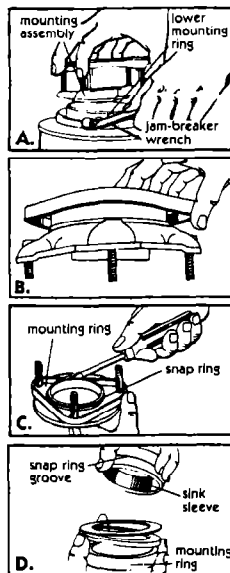

7 Apply rubber gasket or putty to sink flange.

A. The rubber sink flange gasket should always be used where possible. Place rubber gasket over sink flange. Go to Step 7-C.

B. If sink opening does not permit the use of a rubber seal, plumber's putty may be used. Form putty into a long roll by rolling it between your hands. Press roll under sink flange rim.

C. Place flange into sink drain hole. Push down gently, but firmly, to make sure flange sits evenly over gasket or in putty.

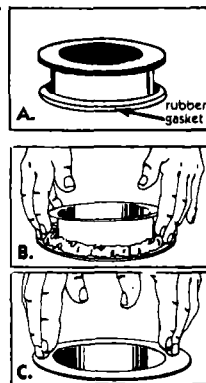

8 Attach the upper mounting assembly.

A. Working from under sink, slip the second rubber gasket, then the metal back-up ring (flat side up), up and over sink flange.

B. Holding the rubber gasket and metal back-up ring in place, attach the mounting ring to the sleeve with the three mounting ring screws. Do NOT tighten screws at this time.

C. Push rubber gasket, metal back-up ring and mounting ring further up sink sleeve. Slide snap ring onto sink sleeve until it pops into place in the sleeve groove.

D. Tighten mounting screws until entire mounting assembly is seated evenly and tightly against sink.

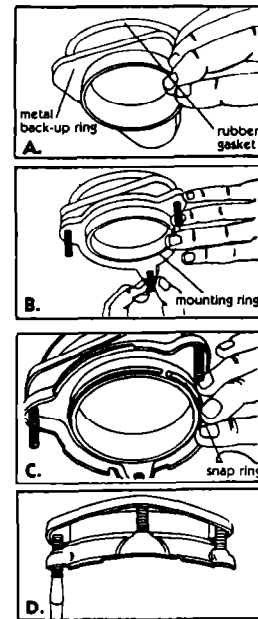

9 Make electrical connections.

A. Remove electrical plate from the bottom of the new disposer. Pull out the black and white electrical wires. Locate the green grounding screw under plate.

B. Insert strain relief into hole. Insert power supply cable through strain relief. Pull cable wires through opening where disposer wires are located. Tighten strain relief screws.

C. Connect power supply cable wires to the disposer wires using electrical wire nuts or by soldering wires together. Be sure to connect **white to white, and black to black**. Wrap wire connections with electrical tape. Put wires back inside disposer housing.

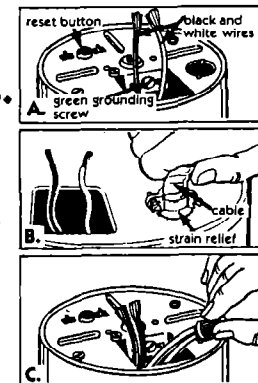

10 Check for proper grounding.

Electrical ground is required on this appliance.

DO NOT reconnect electrical current to main service panel until proper ground is installed.

A. If the cable leading to the disposer has **three wires**, attach the green grounding wire to the green grounding screw. Go to Step 10-D.

B. If the cable does **NOT** have a grounding wire, attach a length of copper wire (no smaller than the other cable wire) to the green grounding screw.

C. Attach the other end of the grounding wire to a grounded metal cold water pipe.* DO NOT ground to a gas supply line or hot water supply line. Use grounding clamp to secure wire to pipe. If non-metal or plastic pipe is used in water connections or water supply, you must have a qualified electrician install a proper ground.

*Grounded cold water pipe must have metal continuity to electrical ground and not be interrupted by plastic, rubber or other electrical-insulating connectors such as hoses, fittings, washers, or gaskets (including water meter or pump).

WARNING: Improper connection of the equipment-grounding line conductor can result in a risk of electrical shock.

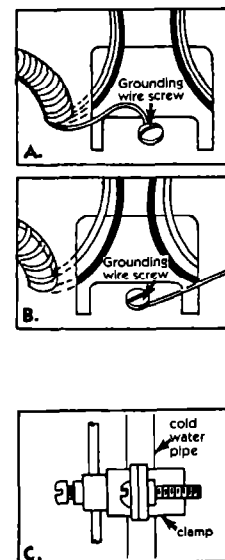

- D. Check to see if you have a water meter in your home. To have a grounded water pipe, the meter **must** have a wire clamp to either side of the meter. You can ground the water pipe by securely clamping a length of No. 6 copper wire for 900 amp service (or less) to bare metal as shown. Use grounding clamps, certified by C.S.A., to attach wire to pipe.

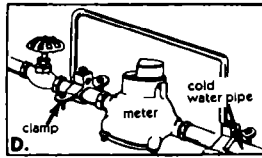

- G. If drain is too short, measure how far trap outlet is from tube and buy a drain trap extension with a slip nut. Install trap extension.

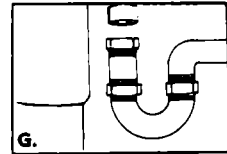

- H. When it fits, tighten the slip nut on the trap. For double sinks, we recommend use of separate traps for disposer and second sink.

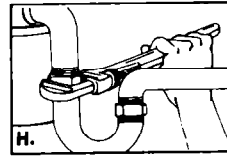

11 Optional dishwasher drain connection

If you do not plan to connect a dishwasher drain to the disposer, go to Step 12.

Lay disposer on its side. Insert tip of screwdriver at an angle into drain hole opening. Tap screwdriver with hammer until molded plug pops out. Remove loose plug from disposer.

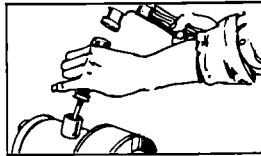

12 Connect disposer to mounting assembly.

- A. Lift the disposer and position it so that the disposer's three mounting ears are lined up **under** the ends of the sink mounting assembly screws.
- B. Holding the disposer in place, turn the lower mounting ring with ears to the right until **all three** ears lock into place in the mounting assembly. The disposer will now hang by itself. The mounting ring will be locked in place later.



13 Attach the disposer waste line pipe to drain trap.

- A. Remove any foreign materials that may have dropped inside the disposer grinding chamber.
- B. Turn the disposer around. Compare your disposer waste line pipe with the two types illustrated in C and D. Attach waste line pipe as specified.
- C. If not already assembled, place the gasket over the end of waste line pipe. Gasket must be installed as shown to prevent leaking. Insert tube into disposer opening. Place flange over waste line pipe and gasket. Secure flange to disposer with screw provided.
- D. Insert the gasket into the disposer discharge outlet. Gasket will be held in place by the waste line pipe flange. Place flange over waste line pipe. Secure flange and waste line pipe to disposer with screw(s) provided.

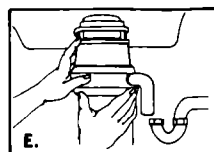
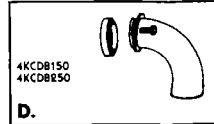
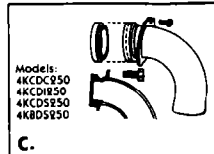
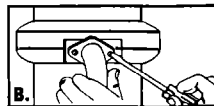
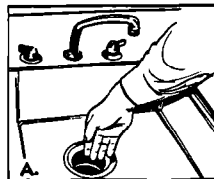

Make sure all connections comply with local plumbing codes.

- F. If tube is too long, saw off excess tubing with a hacksaw. Make sure cut is clean and straight.

PANEL C

14 Optional: Connect to dishwasher drain.

If you do not plan to connect a dishwasher drain to the disposer, go to Step 15.

Make sure connections comply with local plumbing codes.

- A. A dishwasher drain connector kit may be purchased from a hardware store. Use worm gear hose clamp on dishwasher connection. Remove clamp or fitting from end of dishwasher drain hose.

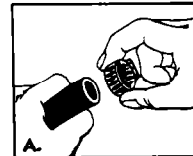

- B. Slide large end of rubber coupler over disposer inlet tube. Fasten coupler to disposer with clamp provided.

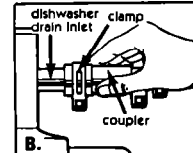

- C. Insert one end of the plastic tube into the coupler and fasten with 22 mm clamp.

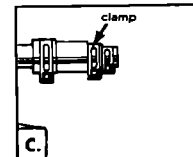

- D. Slip the gear hose clamp over the dishwasher drain hose pushing it back 51-76 mm. Slip drain hose over plastic tube. Slide clamp in place and tighten.

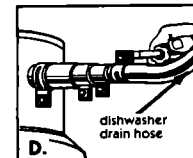

Be sure to tighten all three clamps.

15 Lock disposer in place.

Insert screwdriver or jam-breaker wrench into left side of a disposer mounting lug at the top of the disposer. Turn screwdriver or jam-breaker wrench to right until disposer is locked firmly in place.

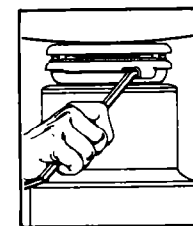

16 Check for leaks and proper operation.

- A. Slowly run water through unit. Then place stopper seal in position and fill sink.
- B. Remove stopper and permit water to flow. Check for leaks at all plumbing connections. If there is a leak, tighten the connection at that point.
- C. Turn water on. Run dispenser for one minute. Check that disposer is operating correctly. Check for leaks at all plumbing connections again. If there is a leak, tighten the connection at that point.

