

This Owner's Manual is provided and hosted by [Appliance Factory Parts](#).

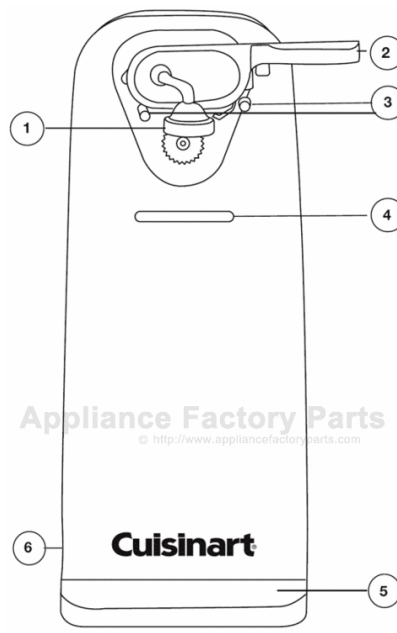

CUISINART CCO-50N Owner's Manual

[Shop genuine replacement parts for CUISINART
CCO-50N](#)



- 1. Power Cut® Blade Assembly
- 2. Can Opener Lever
- 3. Guide Posts
- 4. Can Rest
- 5. Base
- 6. Cord Storage (not shown)

[Find Your CUISINART Small Appliance Parts - Select From 213 Models](#)

----- Manual continues below -----

CLEANING INSTRUCTIONS

1. Be sure plug has been removed from outlet.
2. Remove can opener lever by lifting and pulling toward you. **Use caution, as the blade will be sharp.**
3. Wash by hand with hot, soapy water or place in the top shelf of a dishwasher. Dry thoroughly.
4. Wipe body of can opener with damp cloth. (Caution: Do not immerse in water.)
5. Replace can opener lever by holding in the raised position and pushing back into place. Be sure the lever is pushed all the way in.

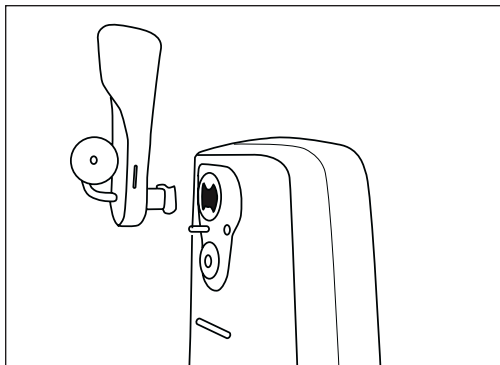

SUGGESTIONS

This can opener will open all standard size cans. It should not be used on cans that have alternate methods of opening (including but not limited to pull-tabs, rolling key and peel-off foil). It also should not be used with rimless cans or cans with angled corners.

Cans with aluminum lids will not adhere to magnet.

If there is a dent in the rim of the can, open other side or place the Power Cut® blade beyond the dent. If the can opener stalls, use a light touch to turn the can to aid the cutting process.

LIMITED THREE-YEAR WARRANTY

This warranty supersedes all previous warranties on Cuisinart® Deluxe Can Opener. This warranty is available to consumers only. You are a consumer if you own a Cuisinart® Deluxe Can Opener that was purchased at retail for personal, family, or household use. Except as otherwise required under applicable state law, this warranty is not available to retailers or other commercial purchasers or owners. We warrant that your Cuisinart® Deluxe Can Opener will be free of defects in material or workmanship under normal home use for three years from the date of original purchase. We suggest that you complete and return the enclosed product registration card promptly to facilitate verification of the date of original purchase. However, return of the product registration card does not eliminate the need for the consumer to maintain the original proof of purchase in order to obtain the warranty benefits. In the event that you do not have proof of purchase date, the purchase date for purposes of this warranty will be the date of manufacture.

If your Cuisinart® Deluxe Can Opener should prove to be defective within the warranty period, we will repair it or, if we think it necessary, replace it. To obtain warranty service, please call our Consumer Service Center toll-free at 1-800-726-0190 or write to:

Cuisinart, 150 Milford Road, East Windsor, NJ 08520

To facilitate the speed and accuracy of your return, please enclose \$10.00 for shipping and handling of the product. Please also be sure to include a return address, daytime phone number, description of the product defect, product serial number (stamped on bottom of product base), and any other information pertinent to the product's return. Please pay by check or money order. (California residents need only supply proof of purchase and should call 1-800-726-0190 for shipping instructions).

NOTE: For added protection and secure handling of any Cuisinart® product that is being returned, we recommend you use a traceable, insured delivery service. Cuisinart cannot be held responsible for in-transit damage or for packages that are not delivered to us. Lost and/or damaged products are not covered under warranty.

Your Cuisinart® Deluxe Can Opener has been manufactured to strict specifications and has been designed for use with the Cuisinart® Deluxe Can Opener accessories and replacement parts. These warranties expressly exclude any defects or damages caused by accessories, replacement parts, or repair service other than those that have been authorized by Cuisinart. These warranties do not cover any damage caused by accident, misuse, shipment, or other than ordinary household use. These warranties exclude all incidental or consequential damages. Some states do not allow the exclusion of or limitation of incidental or consequential damages, so the foregoing limitation may not apply to you.

CALIFORNIA RESIDENTS ONLY

California law provides that for In-Warranty Service, California residents have the option of returning a nonconforming product (A) to the store where it was purchased or (B) to another retail store which sells Cuisinart® products of the same type. The retail store shall then, according to its preferences, either repair the product, refer the consumer to an independent repair facility, replace the product, or refund the purchase price less the amount directly attributable to the consumer's prior usage of the product. If either of the above two options does not result in the appropriate relief to the consumer, the consumer may then take the product to an independent repair facility if service or repair can be economically accomplished.

*Cuisinart and not the consumer will be responsible for the reasonable cost of such service, repair, replacement, or refund for nonconforming products under warranty.

California residents may also, at their preference, return nonconforming products directly to Cuisinart for repair or, if necessary, replacement by calling our Consumer Service Center toll-free at 1-800-726-0190. Cuisinart will be responsible for the cost of the repair, replacement, and shipping and handling for such nonconforming products under warranty.

BEFORE RETURNING YOUR CUISINART PRODUCT

If you are experiencing problems with your Cuisinart® product, we suggest that you call our Consumer Service Center at 1-800-726-0190 before returning the product for servicing. Often, our Consumer Service Representatives can help solve the problem without having the product serviced. If servicing is needed, a Representative can confirm whether the product is under warranty and direct you to the nearest service location.

***Important:** If the nonconforming product is to be serviced by someone other than Cuisinart's Authorized Service Center, please remind the servicer to call our Consumer Service Center at 1-800-726-0190 to ensure that the problem is properly diagnosed, the product is serviced with the correct parts, and to ensure that the product is still under warranty.

© 2008 Cuisinart Cuisinart® is a registered trademark of Cuisinart
150 Milford Road, East Windsor, NJ 08520
Printed in China 08CU015

IB-8176

Cuisinart®



Can Opener

CCO-50 Series

IMPORTANT SAFEGUARDS

When using electrical appliances, basic safety precautions should always be followed including the following:

1. **READ ALL INSTRUCTIONS.**
2. To protect against risk of electrical shock, do not immerse cord, plug or can opener in water or other liquid.
3. Close supervision is necessary when any appliance is used by or near children.
4. Unplug from outlet when not in use, before putting on or taking off parts, and before cleaning.
5. Avoid contact with moving parts.
6. Do not operate any appliance with a damaged cord or plug, or after the appliance malfunctions, or is dropped or damaged in any manner.
7. The use of attachments not recommended or sold by Cuisinart may cause fire, electrical shock, or risk of injury.
8. Do not use outdoors.
9. Do not let cord hang over edge of table or counter, or touch hot surfaces.
10. Do not open pressured (aerosol type) cans.
11. Do not open cans of flammable liquids such as lighter fluid.
12. Do not use can opener for other than intended use.
13. Do not leave unattended while in use.
14. This appliance is intended for household use only and not for commercial or industrial use.
15. **Caution:** Do not immerse in water.

FOR HOUSEHOLD USE ONLY

SAVE THESE INSTRUCTIONS

NOTICE

This appliance has a polarized plug (one blade is wider than the other). As a safety feature, this plug will fit in a polarized outlet only one way. If the plug does not fit fully in the outlet, reverse the plug. If it still does not fit, contact a qualified electrician. Do not attempt to defeat this safety feature.

INTRODUCTION

Congratulations! You're about to see style, convenience, and power come together with your new Cuisinart® electric can opener. With the easy single-touch operation, a precision PowerCut® blade and strong magnetic lid holder, you'll find opening cans has never been easier. The chrome accents and elegant contours add a nice touch and the removable parts make it easy to keep everything clean!

OPERATING INSTRUCTIONS

1. Plug cord into outlet.
2. Raise lever.
3. Position your can under the guiding posts and lower the lever, making sure the Power Cut® blade is positioned inside the rim of the can.
4. Once the Power Cut® blade pierces the can, cutting begins. There is no need to hold the can or the lever down during cutting.
5. Cutting action will automatically stop, once the can is completely open.
6. The can will remain in position until lever is lifted.
7. To remove can, hold can firmly with one hand while lifting lever with other hand.
8. Carefully remove the lid from the magnet.

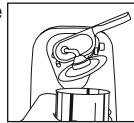
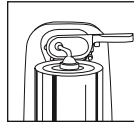
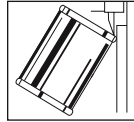
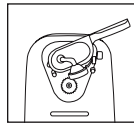

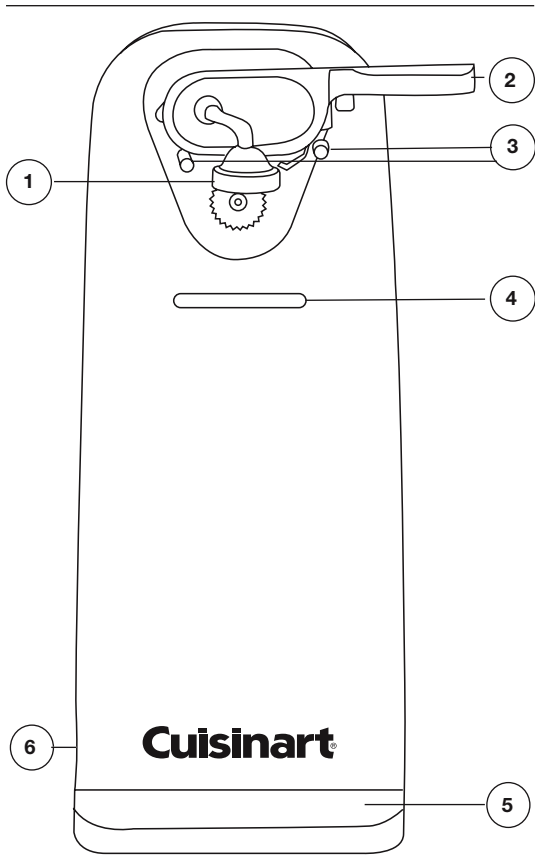

- 1. Power Cut® Blade Assembly**
 - 2. Can Opener Lever**
 - 3. Guide Posts**
 - 4. Can Rest**
 - 5. Base**
 - 6. Cord Storage (not shown)**
-