

This Owner's Manual is provided and hosted by [Appliance Factory Parts](#).



SUNPENTOWN SU-1051B Owner's Manual

[Shop genuine replacement parts for SUNPENTOWN
SU-1051B](#)



[Find Your SUNPENTOWN Humidifier Parts - Select From 13 Models](#)

----- Manual continues below -----



PERSONAL HUMIDIFIER OWNER'S MANUAL

Model SU- 1051

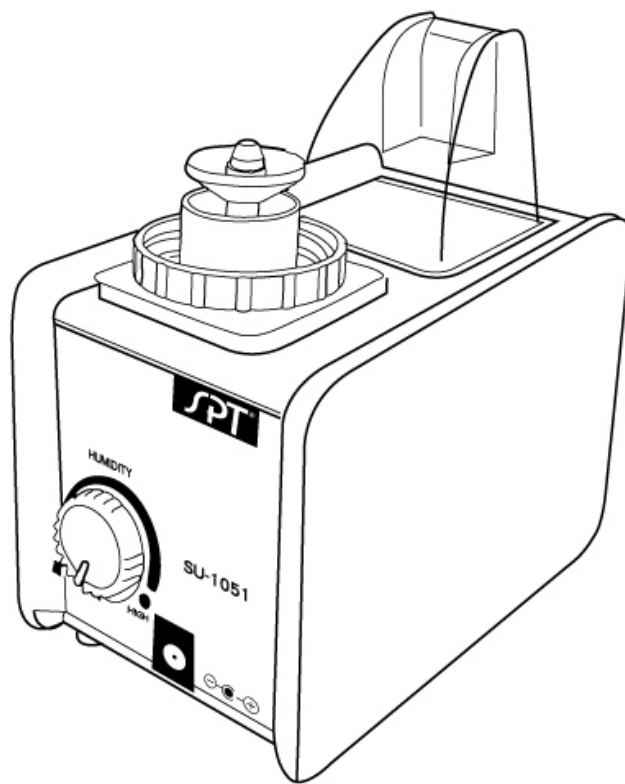

NOTE: AFTER READING THIS MANUAL, IF YOU HAVE ANY QUESTIONS OR COMMENTS ON YOUR SUNPENTOWN PERSONAL HUMIDIFIER, CALL 1- 909-468-5288

NOTE: TO PROLONG THE LIFE OF THIS HUMIDIFIER, THE BEST CHOICE IS TO FILL WITH DISTILLED WATER. FRAGRANCES OR OIL ADDED IN THE WATER WILL CAUSE THE MACHINE TO MALFUNCTION. FRAGRANCES OR OIL ADDED IN THE WATER WILL VOID THE WARRANTY.

(THIS UNIT CAN BE USED IN FOREIGN COUNTRY WITH USE OF COMPATIBLE PLUG ADAPTOR)

 **SUNPENTOWN INTERNATIONAL INC.**

IMPORTANT SAFETY INSTRUCTIONS

READ AND SAVE THESE SAFETY INSTRUCTIONS BEFORE USING THIS HUMIDIFIER

When using electrical appliances, basic precautions should always be followed to reduce the risk of fire, electric shock, and injury to persons, including the following:

1. Always place this humidifier on a firm, flat, dry and level surface. This humidifier may not work properly on an uneven, non-heat-resistant surface, such as carpet, bed or sofa. Do not place near the TV, furniture, mobile phone or other electronics as the mist may cause damages.

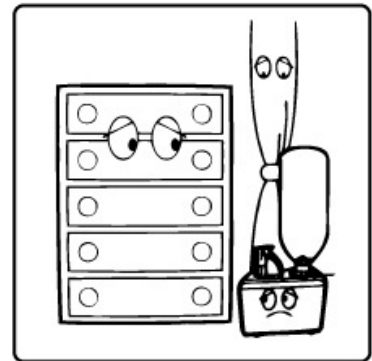
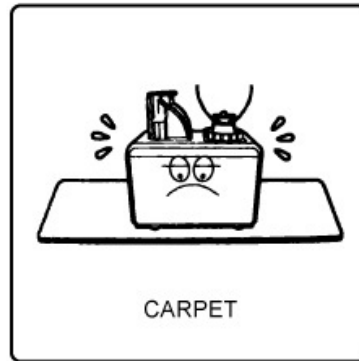
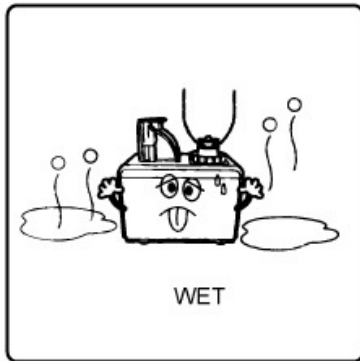

2. Place this humidifier in an area where it is not accessible to children. Should only be used as a humidifier, not intended for any other purpose. Keep cord away from heated surfaces. Do not allow the cord to hang or route where it can be tripped over.

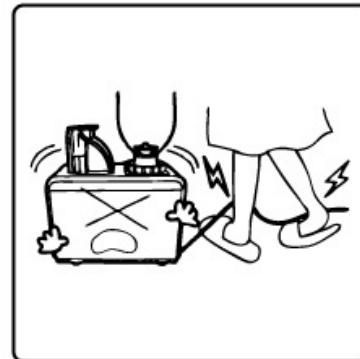
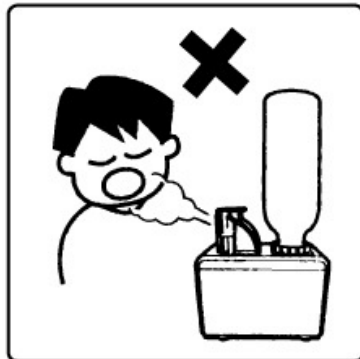

3. Do not place the humidifier near any heat sources such as stoves, radiators, heaters or high moist, freezing areas. Do not pour water into the unit without using a bottle and adaptor cap, as it may overflow.

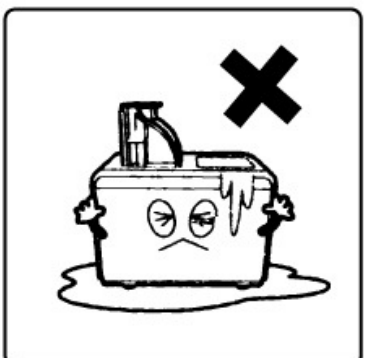
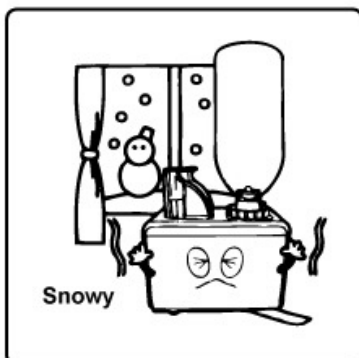
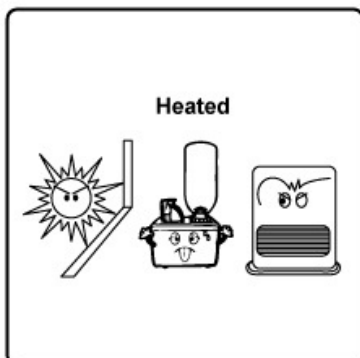

4. Before using the humidifier, check the power cord for any signs of damage. If the cord is damaged, **DO NOT USE** and return the humidifier to the manufacturer under the warranty agreement for repair.
5. A loose fit between the AC outlet (receptacle) and plug may cause overheating and a distortion of the plug. Contact a qualified electrician to replace loose or worn outlet.
6. The humidifier should always be unplugged and emptied when not in operation, while being serviced or cleaned.
7. Never tilt or attempt to move the humidifier while it is operating or filled with water. **Turn unit OFF** and **UNPLUG** the humidifier before moving.
8. This humidifier requires regular cleaning.
9. Turn the humidifier **OFF** if the relative humidity exceeds 60%, or if you notice moisture on the inside of your windows. For proper humidity reading use a hygrometer, which is available in many hardware and department stores.
10. **DO NOT** touch the steam vapor.
11. **DO NOT** block the mist nozzle. This will damage the humidifier.

PART IDENTIFICATION

SIDE VIEW

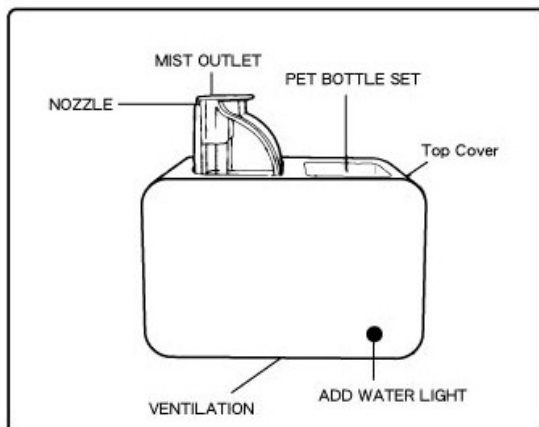

TOP VIEW

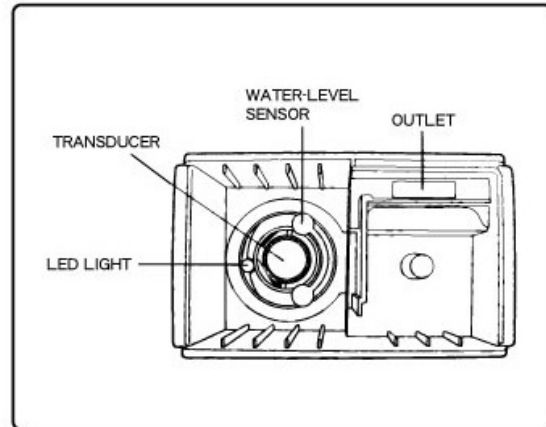

CONTROL PANEL

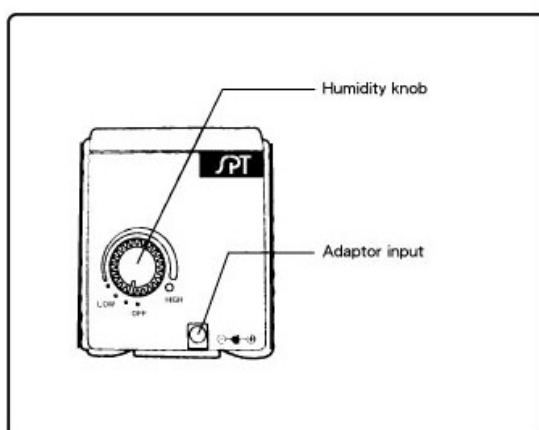

ACCESSORIES

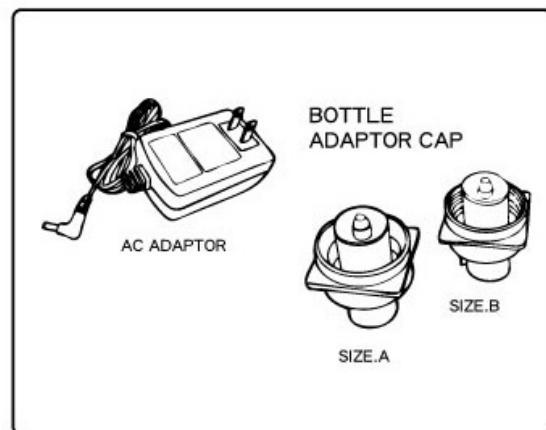

SETUP

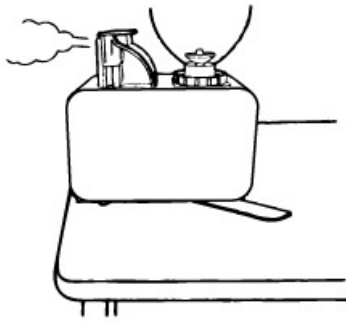

- Select a firm, level, and flat location - at least six inches (15 cm) from any wall or furniture for proper airflow. Place the humidifier on a water-resistant surface, as water can damage furniture and some flooring.

OPERATION

CAUTION: DO NOT PLUG THE HUMIDIFIER WITH WET HANDS AS AN ELECTRICAL SHOCK COULD OCCUR.

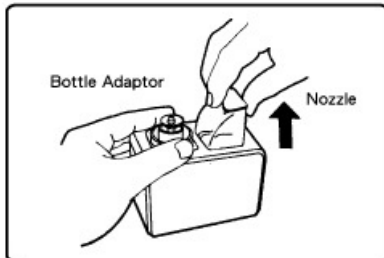

- Position the nozzle on the top cover. Mist outlet can face any direction, but not toward the bottle.



- Fill an empty water bottle (300ml ~ 500ml) with clean or distilled water.
- Do not use Hot Water, doing so may damage the humidifier.

NOTE: TO PROLONG THE LIFE OF THIS HUMIDIFIER, WE RECOMMEND USING DISTILLED WATER. NEVER ADD FRAGRANCES OR OIL IN THE WATER, AS IT WILL CAUSE THE MACHINE TO MALFUNCTION AND VOID YOUR WARRANTY.

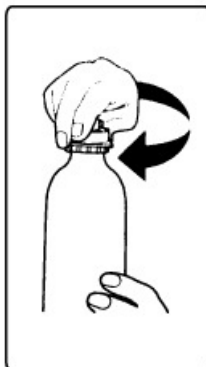

- Fit the appropriate Adaptor Cap to the plastic bottle.
- Screw the Adaptor Cap to the bottle by turning clockwise. Please make sure the Adaptor Cap is securely tightened, but not over-torque.

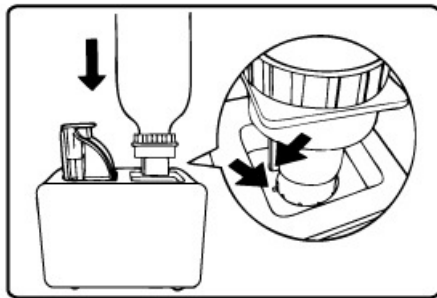

- Align the Adaptor Cap's hook to the indentation on the top cover.

NOTE: Once the bottle has been positioned, do not attempt to move the humidifier. If it has to be moved, turn unit OFF and unplug before moving the unit.

CAUTION: DO NOT POUR WATER TO THE UNIT WITHOUT THE USE OF BOTTLE AND ADAPTOR CAP. DOING SO MAY DAMAGE THE HUMIDIFIER OR CAUSE PERSONAL INJURY.

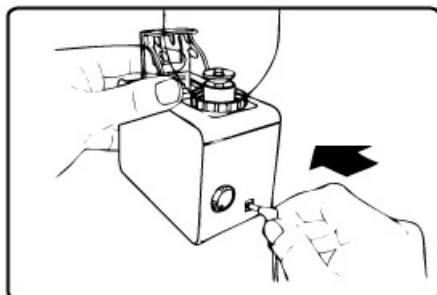

- Plug the DC Adaptor to the humidifier first then connect plug to a 120V outlet.

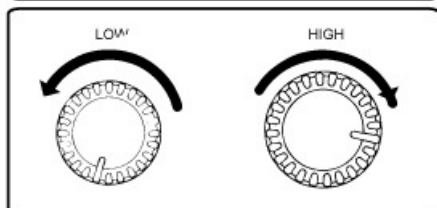

- Turn the Control Knob to adjust the humidity output.

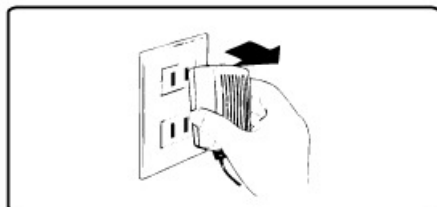

- To disconnect the humidifier, first turn the Control Knob counter-clockwise to OFF position. Then grip the plug and remove from wall outlet. Never pull the plug by the cord.

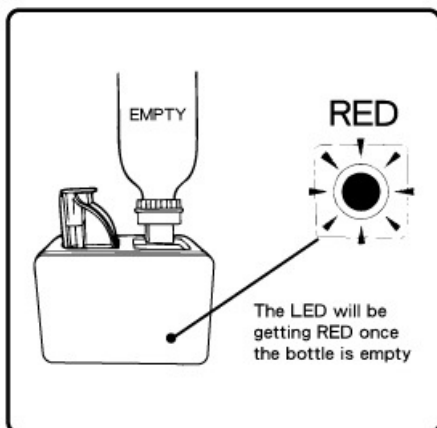

- Add water once the "Add Water" indicator light is RED.

MAINTENANCE

It is recommended to clean the humidifier weekly.



STEP 1: Remove nozzle and lift up the Top Cover, set aside.

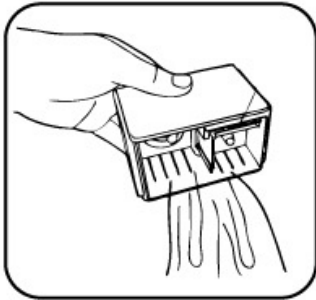

STEP 2: Empty the water in the humidifier.

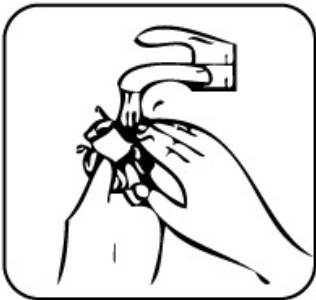

STEP 3: Clean the Adaptor Cap under running water.

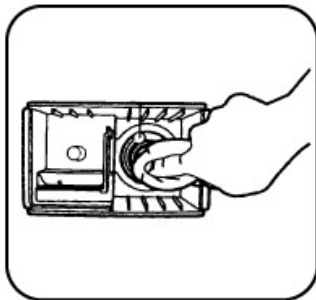

STEP 4: Clean the inside of the unit with a soft cloth.

NOTE: THE USE OF OTHER WATER TREATMENT PRODUCTS, CHEMICALS, SOAPS, DETERGENTS OR ABRASIVE CLEANSERS NOT RECOMMENDED IN THE MANUAL MAY CAUSE DAMAGE TO THE HUMIDIFIER OR AFFECT PERFORMANCE.

NOTE: How often you should perform this maintenance depends upon the hardness of the water you are using and how quickly mineral deposits form on the interior surfaces of the humidifier.

DO NOT CLEAN this humidifier under running water or submerge in water or any liquid. Doing so may cause damage or personal injury.

TROUBLESHOOTING

- A. No power to the unit when turned on.**
- Check if the DC adaptor is securely plugged to the unit and the wall outlet.
 - Check the electrical outlet with a working appliance.
- B. Power to unit, but not producing mist.**
- Turn unit OFF. Remove bottle and re-insert, making sure the Adaptor Cap is properly fitted.
- C. Mist is stuck inside the nozzle.**
- Sometimes water droplets may block the Mist Outlet. Turn unit OFF, remove the nozzle and dry the outlet area.
- D. Humidifier is overflowing.**
- Turn unit OFF. Remove bottle and check the Adaptor Cap is properly fitted on the bottle.
 - When placing the bottle onto the unit, do not squeeze to bottle to force water into the unit.
 - Once the bottle is properly fitted onto the unit, do not move the bottle – this will cause more water to be released into the unit.

END-OF-THE-SEASON CARE AND STORAGE

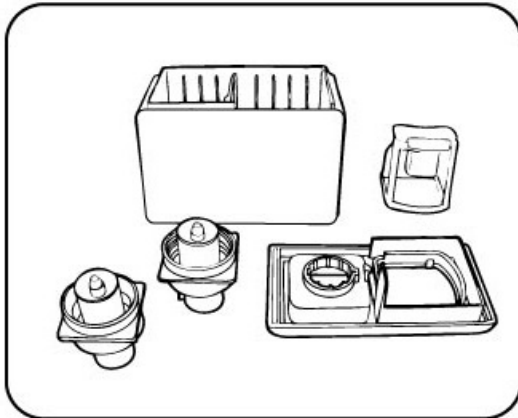

- Follow **WEEKLY CLEANING** instructions when the humidifier will not be used for at least a week or more, or at the end of the season.
- Dry the humidifier and all accessories completely before storing. **DO NOT** store with water or any moisture inside the humidifier.
- Pack the unit in its original carton and store in a cool, dry location.
- Before next use, remember to clean the humidifier.

TECHNICAL SPECIFICATIONS

Model	SU-1051
Length	4.33 in
Width	2.56 in
Height	3 in
Weight	0.91 lbs
Input Voltage/W	100~240 volts AC, 50~ 60Hz, 15W

CUSTOMER ASSISTANCE LINE

If you experience a problem, please see the warranty for information. Please **DO NOT** attempt to repair this unit yourself. Doing so, will void your warranty and could cause damage to the fan or personal injury to yourself. If you have any questions concerning this appliance, please call: **1- 909-468-5288**



YOUR GUARANTEE

If this product is found to be faulty as a result of faulty materials or workmanship within one year from date of purchase, it will be repaired free of charge.

This guarantee is subject to the following terms:

- Sunpentown must be notified of the fault.
- Proof of purchase must be presented to Sunpentown's nominated representative.
- The warranty will be void if the product is modified, misused or repaired by an unauthorized person.
- The warranty after repair will not be extended beyond the original one-year period.
- All replacement parts will be new or reconditioned.
- Parts, which are replaced, become the property of Sunpentown.
- The warranty applies for the use of the product in the USA only.

What is **NOT COVERED**:

- Warranty does not include freight charges.
- Incidental or consequential damage caused by possible defects with this product.
- Damage to product caused by improper power supply voltage, accident, fire, floods or acts of nature.
- Failure of product resulting from unauthorized modifications to the product.
- Improper installation or failure to perform the necessary maintenance.

This GUARANTEE is in addition to your Statutory Rights

SUNPENTOWN INTERNATIONAL INC.
21415 Baker Parkway, City of Industry, CA 91789-5236
Tel: 909-468-5288 · Fax: 909-468-5279
service@sunpentown.com
www.sunpentown.com