

This Owner's Manual is provided and hosted by [Appliance Factory Parts](#).



# GE JES1142WD04 Owner's Manual

[Shop genuine replacement parts for GE JES1142WD04](#)



[Find Your GE Microwave Parts - Select From 3055 Models](#)

----- Manual continues below -----



# Microwave Oven

*Safety Instructions* .....2-6

***Operating Instructions***

Convenience Features . . . .13-15

Microwave Terms . . . . .18

Oven Features . . . . .7, 8

Other Features . . . . .16, 17

Power Levels . . . . .9

Time Features . . . . .10-12

*Care and Cleaning* . . . . .19

*Troubleshooting Tips* . . . . .20

Things That Are Normal . . . . .20

***Consumer Support***

Consumer Support . . .Back Cover

Product Registration . . . . .21, 22

Warranty . . . . .23

**Owner's Manual**

JES1142

**Write the model and serial numbers here:**

**Model #** \_\_\_\_\_

**Serial #** \_\_\_\_\_

You can find them on a label inside the oven.



# IMPORTANT SAFETY INSTRUCTIONS. READ ALL INSTRUCTIONS BEFORE USING.

## ⚠ WARNING!

For your safety, the information in this manual must be followed to minimize the risk of fire or explosion, electric shock, or to prevent property damage, personal injury, or loss of life.

### PRECAUTIONS TO AVOID POSSIBLE EXPOSURE TO EXCESSIVE MICROWAVE ENERGY

- (a) **Do Not Attempt** to operate this oven with the door open since open-door operation can result in harmful exposure to microwave energy. It is important not to defeat or tamper with the safety interlocks.
- (b) **Do Not Place** any object between the oven front face and the door or allow soil or cleaner residue to accumulate on sealing surfaces.
- (c) **Do Not Operate** the oven if it is damaged. It is particularly important that the oven door close properly and that there is no damage to the:
  - (1) door (bent),
  - (2) hinges and latches (broken or loosened),
  - (3) door seals and sealing surfaces.
- (d) **The Oven Should Not** be adjusted or repaired by anyone except properly qualified service personnel.

## IMPORTANT SAFETY INSTRUCTIONS.

Use this appliance only for its intended purpose as described in this Owner's Manual.

When using electrical appliances basic safety precautions should be followed, including the following:

- Read and follow the specific precautions in the *Precautions to Avoid Possible Exposure to Excessive Microwave Energy* section above.
- This appliance must be grounded. Connect only to a properly grounded outlet. See the *Grounding Instructions* section on page 5.
- Install or locate this appliance only in accordance with the provided installation instructions.
- Be certain to place the front surface of the door 3" or more back from the countertop edge to avoid accidental tipping of the appliance in normal usage.
- This microwave oven is not approved or tested for marine use.
- Do not mount this appliance over a sink.
- Do not mount the microwave oven over or near any portion of a heating or cooking appliance.
- Do not store anything directly on top of the microwave oven surface when the microwave oven is in operation.
- Do not operate this appliance if it has a damaged power cord or plug, if it is not working properly, or if it has been damaged or dropped.
- Do not cover or block any openings on the appliance.
- Use this appliance only for its intended use as described in this manual. Do not use corrosive chemicals or vapors in this appliance. This microwave oven is specifically designed to heat, dry or cook food, and is not intended for laboratory or industrial use.
- Do not store this appliance outdoors. Do not use this product near water—for example, in a wet basement, near a swimming pool, near a sink or in similar locations.
- Keep power cord away from heated surfaces.
- Do not immerse power cord or plug in water.
- Do not let power cord hang over edge of table or counter.
- To reduce the risk of fire in the oven cavity:
  - Do not overcook food. Carefully attend appliance when paper, plastic or other combustible materials are placed inside the oven while cooking.
  - Remove wire twist-ties and metal handles from paper or plastic containers before placing them in the oven.
  - Do not use the oven for storage purposes. Do not leave paper products, cooking utensils or food in the oven when not in use.
  - If materials inside the oven ignite, keep the oven door closed, turn the oven off and disconnect the power cord, or shut off power at the fuse or circuit breaker panel. If the door is opened, the fire may spread.
- See door surface cleaning instructions in the *Care and cleaning of the microwave oven* section of this manual.
- This appliance must only be serviced by qualified service personnel. Contact the nearest authorized service facility for examination, repair or adjustment.
- As with any appliance, close supervision is necessary when used by children.

## SAVE THESE INSTRUCTIONS

## ⚠ WARNING!



### ARCING

If you see arcing, press the **CLEAR/OFF** pad and correct the problem.

Arcing is the microwave term for sparks in the oven. Arcing is caused by:

- Metal or foil touching the side of the oven.
- Foil not molded to food (upturned edges act like antennas).
- Metal, such as twist-ties, poultry pins or gold-rimmed dishes, in the microwave.
- Recycled paper towels containing small metal pieces being used in the microwave.



### FOODS

- Do not pop popcorn in your microwave oven unless in a special microwave popcorn accessory or unless you use popcorn labeled for use in microwave ovens.
  - Some products such as whole eggs and sealed containers—for example, closed jars—are able to explode and should not be heated in this microwave oven. Such use of the microwave oven could result in injury.
  - Do not boil eggs in a microwave oven. Pressure will build up inside egg yolk and will cause it to burst, possibly resulting in injury.
  - Operating the microwave with no food inside for more than a minute or two may cause damage to the oven and could start a fire. It increases the heat around the magnetron and can shorten the life of the oven.
  - Foods with unbroken outer “skin” such as potatoes, hot dogs, sausages, tomatoes, apples, chicken livers and other giblets and egg yolks should be pierced to allow steam to escape during cooking.
  - Avoid heating baby food in glass jars, even with the lid off. Make sure all infant food is thoroughly cooked. Stir food to distribute the heat evenly. Be careful to prevent scalding when warming formula. The container may feel cooler than the formula really is. Always test the formula before feeding the baby.
  - Don't defrost frozen beverages in narrow-necked bottles (especially carbonated beverages). Even if the container is opened, pressure can build up. This can cause the container to burst, possibly resulting in injury.
- **SUPERHEATED WATER**
- Liquids, such as water, coffee or tea are able to be overheated beyond the boiling point without appearing to be boiling. Visible bubbling or boiling when the container is removed from the microwave oven is not always present. THIS COULD RESULT IN VERY HOT LIQUIDS SUDDENLY BOILING OVER WHEN THE CONTAINER IS DISTURBED OR A SPOON OR OTHER UTENSIL IS INSERTED INTO THE LIQUID.*
- To reduce the risk of injury to persons:
- Do not overheat the liquid.
  - Stir the liquid both before and halfway through heating it.
  - Do not use straight-sided container with narrow necks.
  - After heating, allow the container to stand in the microwave oven for a short time before removing the container.
  - Use extreme care when inserting a spoon or other utensil into the container.
- Hot foods and steam can cause burns. Be careful when opening any containers of hot food, including popcorn bags, cooking pouches and boxes. To prevent possible injury, direct steam away from hands and face.
  - Do not overcook potatoes. They could dehydrate and catch fire, causing damage to your oven.
  - Cook meat and poultry thoroughly—meat to at least an INTERNAL temperature of 160°F and poultry to at least an INTERNAL temperature of 180°F. Cooking to these temperatures usually protects against foodborne illness.

# IMPORTANT SAFETY INFORMATION. READ ALL INSTRUCTIONS BEFORE USING.

## ▲ WARNING!



### MICROWAVE-SAFE COOKWARE

Make sure all cookware used in your microwave oven is suitable for microwaving. Most glass casseroles, cooking dishes, measuring cups, custard cups, pottery or china dinnerware which does not have metallic trim or glaze with a metallic sheen can be used. Some cookware is labeled “suitable for microwaving.”

- If you are not sure if a dish is microwave-safe, use this test: Place in the oven both the dish you are testing and a glass measuring cup filled with 1 cup of water—set the measuring cup either in or next to the dish. Microwave 30–45 seconds at high. If the dish heats, it should not be used for microwaving.

If the dish remains cool and only the water in the cup heats, then the dish is microwave-safe.

- If you use a meat thermometer while cooking, make sure it is safe for use in microwave ovens.
- Do not use recycled paper products. Recycled paper towels, napkins and waxed paper can contain metal flecks which may cause arcing or ignite. Paper products containing nylon or nylon filaments should be avoided, as they may also ignite.
- Some styrofoam trays (like those that meat is packaged on) have a thin strip of metal embedded in the bottom. When microwaved, the metal can burn the floor of the oven or ignite a paper towel.
- Do not use the microwave to dry newspapers.
- Not all plastic wrap is suitable for use in microwave ovens. Check the package for proper use.
- Paper towels, waxed paper and plastic wrap can be used to cover dishes in order to retain moisture and prevent spattering. Be sure to vent plastic wrap so steam can escape.

- Cookware may become hot because of heat transferred from the heated food. Pot holders may be needed to handle the cookware.
- “Boilable” cooking pouches and tightly closed plastic bags should be slit, pierced or vented as directed by package. If they are not, plastic could burst during or immediately after cooking, possibly resulting in injury. Also, plastic storage containers should be at least partially uncovered because they form a tight seal. When cooking with containers tightly covered with plastic wrap, remove covering carefully and direct steam away from hands and face.
- Use foil only as directed in this guide. TV dinners may be microwaved in foil trays less than 3/4” high; remove the top foil cover and return the tray to the box. When using foil in the microwave oven, keep the foil at least 1” away from the sides of the oven.
- Plastic cookware—Plastic cookware designed for microwave cooking is very useful, but should be used carefully. Even microwave-safe plastic may not be as tolerant of overcooking conditions as are glass or ceramic materials and may soften or char if subjected to short periods of overcooking. In longer exposures to overcooking, the food and cookware could ignite.

*Follow these guidelines:*

- 1 Use microwave-safe plastics only and use them in strict compliance with the cookware manufacturer’s recommendations.
- 2 Do not microwave empty containers.
- 3 Do not permit children to use plastic cookware without complete supervision.



## GROUNDING INSTRUCTIONS

**WARNING**—Improper use of the grounding plug can result in a risk of electric shock.

This appliance must be grounded. In the event of an electrical short circuit, grounding reduces the risk of electric shock by providing an escape wire for the electric current.

This appliance is equipped with a power cord having a grounding wire with a grounding plug. The plug must be plugged into an outlet that is properly installed and grounded.

Consult a qualified electrician or service technician if the grounding instructions are not completely understood, or if doubt exists as to whether the appliance is properly grounded.

If the outlet is a standard 2-prong wall outlet, it is your personal responsibility and obligation to have it replaced with a properly grounded 3-prong wall outlet.

Do not under any circumstances cut or remove the third (ground) prong from the power cord.

We do not recommend using an extension cord with this appliance. If the power cord is too short, have a qualified electrician or service technician install an outlet near the appliance. (See *EXTENSION CORDS* section.)

For best operation, plug this appliance into its own electrical outlet to prevent flickering of lights, blowing of fuse or tripping of circuit breaker.



## ADAPTER PLUGS

**Usage situations where appliance's power cord will be disconnected infrequently.**

Because of potential safety hazards under certain conditions, **we strongly recommend against the use of an adapter plug.**

However, if you still elect to use an adapter, where local codes permit, a **TEMPORARY CONNECTION** may be made to a properly grounded 2-prong wall receptacle by the use of a UL listed adapter which is available at most local hardware stores.

The larger slot in the adapter must be aligned with the larger slot in the wall receptacle to provide proper polarity in the connection of the power cord.

**CAUTION:** Attaching the adapter ground terminal to the wall receptacle cover screw does not ground the appliance unless the cover screw is metal, and not insulated, and the wall receptacle is grounded through the house wiring.

You should have the circuit checked by a qualified electrician to make sure the receptacle is properly grounded.

When disconnecting the power cord from the adapter, always hold the adapter with one hand. If this is not done, the adapter ground terminal is very likely to break with repeated use. Should this happen, **DO NOT USE** the appliance until a proper ground has again been established.

**Usage situations where appliance's power cord will be disconnected frequently.**

**Do not use an adapter plug** in these situations because frequent disconnection of the power cord places undue strain on the adapter and leads to eventual failure of the adapter ground terminal. You should have the 2-prong wall receptacle replaced with a 3-prong (grounding) receptacle by a qualified electrician before using the appliance.

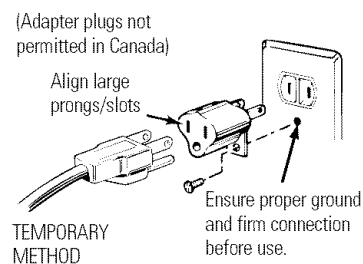

**IMPORTANT SAFETY INFORMATION.  
READ ALL INSTRUCTIONS BEFORE USING.**

---

**▲ WARNING!**

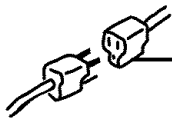

**EXTENSION CORDS**

---

A short power supply cord is provided to reduce the risks resulting from becoming entangled in or tripping over a longer cord.

Extension cords may be used if you are careful in using them.

*If an extension cord is used—*

- 1** The marked electrical rating of the extension cord should be at least as great as the electrical rating of the appliance;
- 2** The extension cord must be a grounding-type 3-wire cord and it must be plugged into a 3-slot outlet;
- 3** The extension cord should be arranged so that it will not drape over the countertop or tabletop where it can be pulled on by children or tripped over unintentionally.

If you use an extension cord, the interior light may flicker and the blower sound may vary when the microwave oven is on. Cooking times may be longer, too.



**READ AND FOLLOW THIS SAFETY INFORMATION CAREFULLY.**

---

**SAVE THESE INSTRUCTIONS**

# About the features of your microwave oven.

ge.com

Throughout this manual, features and appearance may vary from your model.

1100 Watts

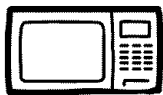
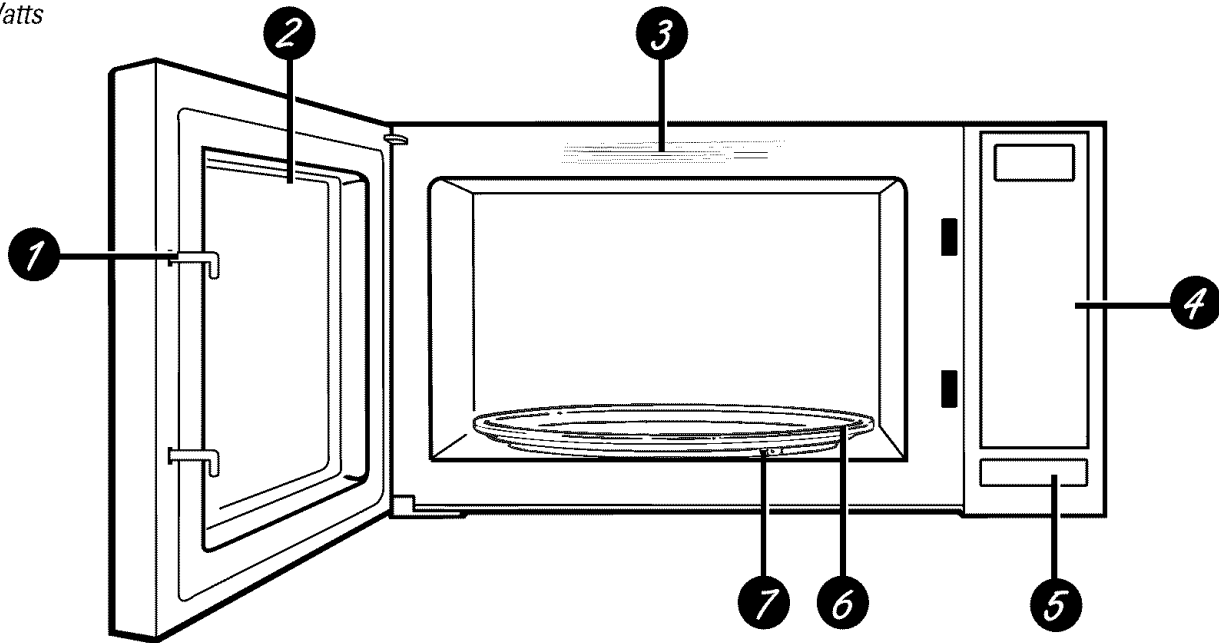

## Features of the Oven

- 1 Door Latches.**
- 2 Window with Metal Shield.** Screen allows cooking to be viewed while keeping microwaves confined in the oven.
- 3 Convenience Guide.**
- 4 Touch Control Panel Display.**
- 5 Door Latch Release.** Press latch release to open door.
- 6 Removable Turntable.** Turntable and support **must** be in place when using the oven. The turntable may be removed for cleaning.
- 7 Removable Turntable Support.** The turntable support must be in place when using the oven.

**NOTE:** Rating plate, oven vent(s) and oven light are located on the inside walls of the microwave oven.



# About the features of your microwave oven.

You can microwave by time or with the convenience features.

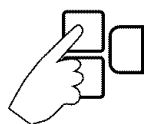
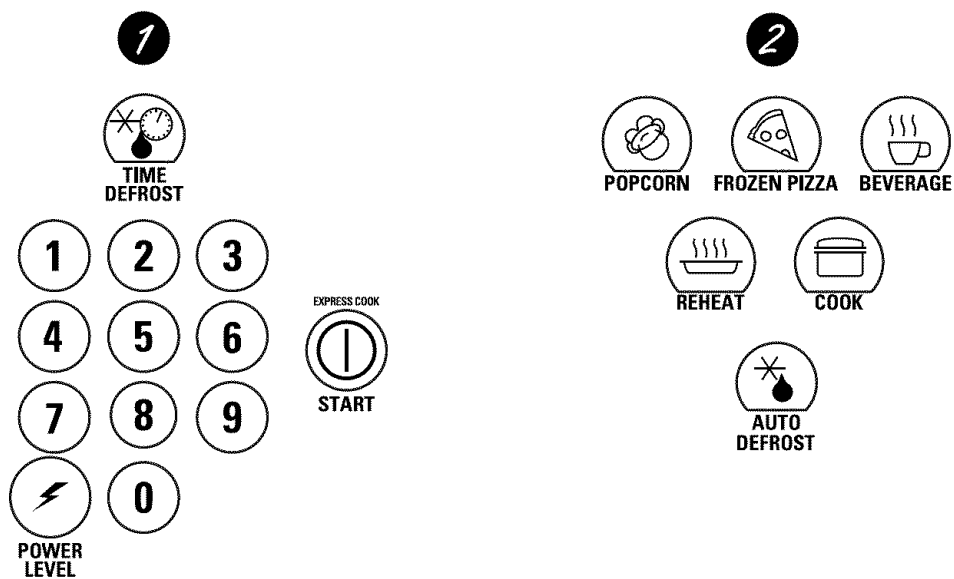

## Cooking Controls

Check the Convenience Guide before you begin.

### 1 Time Features

| Press                                 | Enter                     |
|---------------------------------------|---------------------------|
| <b>Time Cook</b><br>Press number pads | Amount of cooking time    |
| <b>TIME DEFROST</b>                   | Amount of defrosting time |
| <b>POWER LEVEL</b>                    | Power level 0 to HI       |
| <b>EXPRESS COOK</b>                   | Starts immediately!       |

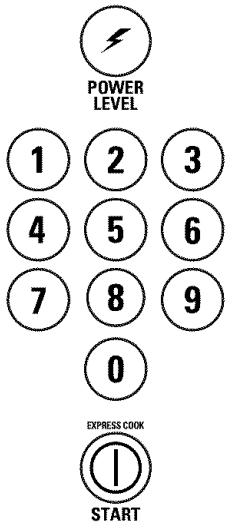

The power level may be entered or changed before entering the time for **Time Cook**.

- 1 Press **POWER LEVEL** repeatedly to select power level **0** to **HI**.
- 2 Enter cooking time.
- 3 Press **START**.

Variable power levels add flexibility to microwave cooking. The power levels on the microwave oven can be compared to the surface units on a range. Each power level gives you microwave energy a certain percent of the time. **Power level 70** is microwave energy 70% of the time. **Power level 30** is energy 30% of the time. Most cooking will be done on **HI** which gives you 100% power. **HI power level** will cook faster but food may need more frequent stirring, rotating or turning over. A lower setting will cook more evenly and need less stirring or rotating of the food. Some foods may have better flavor, texture or appearance if one of the lower settings is used. Use a lower power level when cooking foods that have a tendency to boil over, such as scalloped potatoes.

Rest periods (when the microwave energy cycles off) give time for the food to “equalize” or transfer heat to the inside of the food. An example of this is shown with **power level 30**—the defrost cycle. If microwave energy did not cycle off, the outside of the food would cook before the inside was defrosted.

*Here are some examples of uses for various power levels:*

**HI:** Fish, bacon, vegetables, boiling liquids.

**Med-High 70:** Gentle cooking of meat and poultry; baking casseroles and reheating.

**Medium 50:** Slow cooking and tenderizing for stews and less tender cuts of meat.

**Low 20 or 30:** Defrosting; simmering; delicate sauces.

**Warm 10:** Keeping food warm; softening butter.

## About the time features.

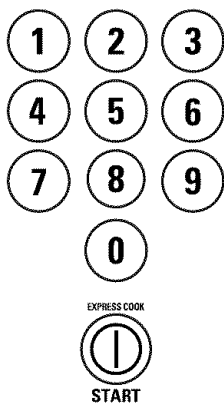

### Time Cook

Allows you to microwave for any time up to 99 minutes and 99 seconds.

**HI power level** is automatically set, but you may change it for more flexibility.

**1** Change power level if you don't want full power. (Press **POWER LEVEL** repeatedly to select a desired power level.)

**2** Enter cooking time.

**3** Press **START**.

You may open the door during **Time Cook** to check the food. Close the door and press **START** to resume cooking.

### Defrosting and Cooking

You can program the oven to automatically begin **Time Cook** after defrosting.

**1** Press **AUTO DEFROST** and select food weight, or press **TIME DEFROST** and enter defrosting time.

**2** Press **POWER LEVEL**. Change power level if you don't want full power. (Press **POWER LEVEL** repeatedly to select a desired power level.)

**3** Enter the amount of cooking time.

**4** Press **START**.

The oven will begin defrosting. After defrosting is complete, **Time Cook** will count down.



### Express Cook

This is a quick way to set cooking time for 30 seconds. It will add 30 seconds to the time each time the pad is pressed. The oven will start immediately.

## Cooking Guide for Time Cook

**NOTE:** Use **HI** power level unless otherwise noted.

| Vegetable                                    | Amount                           | Time                                  | Comments  |
|--|----------------------------------|---------------------------------------|---|
| <b>Asparagus</b><br>(fresh spears)           | 1 lb.                            | 5 to 8 min.,<br>Med-High (7)          | In 1½-qt. casserole, place 1/4 cup water.   |
| (frozen spears)                              | 10-oz. package                   | 4 to 7 min.                           | In 1-qt. casserole.   |
| <b>Beans</b><br>(fresh green)                | 1 lb. cut in half                | 10 to 15 min.                         | In 1½-qt. casserole, place 1/2 cup water.   |
| (frozen green)                               | 10-oz. package                   | 4 to 8 min.                           | In 1-qt. casserole, place 2 tablespoons water.  |
| (frozen lima)                                | 10-oz. package                   | 4 to 8 min.                           | In 1-qt. casserole, place 1/4 cup water.  |
| <b>Beets</b><br>(fresh, whole)               | 1 bunch                          | 16 to 22 min.                         | In 2-qt. casserole, place 1/2 cup water.  |
| <b>Broccoli</b><br>(fresh cut)               | 1 bunch (1¼ to 1½ lbs.)          | 5 to 9 min.                           | In 2-qt. casserole, place 1/2 cup water.  |
| (fresh spears)                               | 1 bunch (1¼ to 1½ lbs.)          | 7 to 11 min.                          | In 2-qt. casserole, place 1/4 cup water.  |
| (frozen, chopped)                            | 10-oz. package                   | 4 to 7 min.                           | In 1-qt. casserole.   |
| (frozen spears)                              | 10-oz. package                   | 4 to 7 min.                           | In 1-qt. casserole, place 3 tablespoons water.  |
| <b>Cabbage</b><br>(fresh)                    | 1 medium head (about 2 lbs.)     | 6 to 10 min.                          | In 1½- or 2-qt. casserole, place 1/4 cup water.   |
| (wedges)                                     |                                  | 5 to 9 min.                           | In 2- or 3-qt. casserole, place 1/4 cup water.  |
| <b>Carrots</b><br>(fresh, sliced)            | 1 lb.                            | 4 to 8 min.                           | In 1½-qt. casserole, place 1/4 cup water.   |
| (frozen)                                     | 10-oz. package                   | 3 to 7 min.                           | In 1-qt. casserole, place 2 tablespoons water.  |
| <b>Cauliflower</b><br>(flowerets)            | 1 medium head                    | 7 to 11 min.                          | In 2-qt. casserole, place 1/2 cup water.  |
| (fresh, whole)                               | 1 medium head                    | 7 to 15 min.                          | In 2-qt. casserole, place 1/2 cup water.  |
| (frozen)                                     | 10-oz. package                   | 3 to 7 min.                           | In 1-qt. casserole, place 2 tablespoons water.  |
| <b>Corn</b><br>(frozen kernel)               | 10-oz. package                   | 2 to 6 min.                           | In 1-qt. casserole, place 2 tablespoons water.  |
| <b>Corn on the cob</b><br>(fresh)            | 1 to 5 ears                      | 1¼ to 4 min.<br>per ear               | In 2-qt. glass baking dish, place corn. If corn is in husk, use no water; if corn has been husked, add 1/4 cup water. Rearrange after half of time. |
| (frozen)                                     | 1 ear<br>2 to 6 ears             | 3 to 6 min.<br>2 to 3 min.<br>per ear | Place in 2-qt. oblong glass baking dish. Cover with vented plastic wrap. Rearrange after half of time.  |
| <b>Mixed vegetables</b><br>(frozen)          | 10-oz. package                   | 2 to 6 min.                           | In 1-qt. casserole, place 3 tablespoons water.  |
| <b>Peas</b><br>(fresh, shelled)              | 2 lbs. unshelled                 | 7 to 10 min.                          | In 1-qt. casserole, place 1/4 cup water.  |
| (frozen)                                     | 10-oz. package                   | 2 to 6 min.                           | In 1-qt. casserole, place 2 tablespoons water.  |
| <b>Potatoes</b><br>(fresh, cubed, white)     | 4 potatoes (6 to 8 oz. each)     | 9 to 12 min.                          | Peel and cut into 1-inch cubes. Place in 2-qt. casserole with 1/2 cup water. Stir after half of time.   |
| (fresh, whole, sweet or white)               | 1 (6 to 8 oz.)                   | 2 to 4 min.                           | Pierce with cooking fork. Place in the oven, 1 inch apart, in circular arrangement. Let stand 5 minutes.  |
| <b>Spinach</b><br>(fresh)                    | 10 to 16 oz.                     | 3 to 6 min.                           | In 2-qt. casserole, place washed spinach.   |
| (frozen, chopped, and leaf)                  | 10-oz. package                   | 3 to 6 min.                           | In 1-qt. casserole, place 3 tablespoons water.  |
| <b>Squash</b><br>(fresh, summer, and yellow) | 1 lb. sliced                     | 3 to 5 min.                           | In 1½-qt. casserole, place 1/4 cup water.   |
| (winter, acorn, or butternut)                | 1 to 2 squash (about 1 lb. each) | 5 to 9 min.                           | Cut in half and remove fibrous membranes. In 2-qt. glass baking dish, place squash cut-side-down. Turn cut-side-up after 4 minutes.                 |

## About the time features.

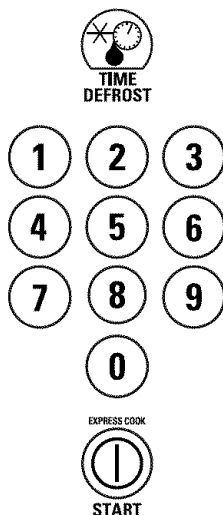

### Time Defrost

Allows you to defrost for a selected length of time. See the Defrosting Guide for suggested times. (**Auto Defrost** explained in the *About the convenience features* section.)

- 1** Press **TIME DEFROST**.
- 2** Enter defrosting time.
- 3** Press **START**.
- 4** Turn the food over after half the time.
- 5** Press **START**.

At one half of selected defrosting time, turn food over and break apart or rearrange pieces for more even defrosting. Shield any warm areas with small pieces of foil. The oven will continue to defrost if you don't open the door and turn the food.

A dull thumping noise may be heard during defrosting. This is normal when oven is not operating at **HI** power.

### Defrosting Tips

- Foods frozen in paper or plastic can be defrosted in the package. Closed packages should be slit, pierced or vented **AFTER** food has partially defrosted. Plastic storage containers should be partially uncovered.
- Family-size, prepackaged frozen dinners can be defrosted and microwaved. If the food is in a foil container, transfer it to a microwave-safe dish.
- Foods that spoil easily should not be allowed to sit out for more than one hour after defrosting. Room temperature promotes the growth of harmful bacteria.
- For more even defrosting of larger foods, such as roasts, use **Auto Defrost**. Be sure large meats are completely defrosted before cooking.
- When defrosted, food should be cool but softened in all areas. If still slightly icy, return to the microwave very briefly, or let it stand a few minutes.

### Defrosting Guide

| Food   | Time  | Comments  |
|--|---|---|
| <b>Breads, Cakes</b><br><i>Bread, buns, or rolls (1 piece)</i><br><i>Sweet rolls (approx. 12 oz.)</i>  | 1/4 min.<br>2 to 4 min.   | Rearrange after half the time.  |
| <b>Fish and Seafood</b><br><i>Fillets, frozen (1 lb.)</i><br><i>Shellfish, small pieces (1 lb.)</i>  | 6 to 9 min.<br>3 to 7 min.  | Place block in casserole. Turn over and break up after half the time.   |
| <b>Fruit</b><br><i>Plastic pouch—1 or 2 (10-oz. package)</i>   | 1 to 5 min.   |   |
| <b>Meat</b><br><i>Bacon (1 lb.)</i><br><i>Franks (1 lb.)</i><br><i>Ground meat (1 lb.)</i><br><i>Roast: beef, lamb, veal, pork</i>   | 2 to 5 min.<br>2 to 5 min.<br>4 to 6 min.<br>9 to 13 min. per lb.             | Place unopened package in oven. Let stand 5 minutes after defrosting.<br>Place unopened package in oven. Microwave just until franks can be separated. Let stand 5 minutes, if necessary, to complete defrosting.<br>Turn meat over after first half of time.<br>Use <b>power level 10</b> .  |
| <i>Steaks, chops and cutlets</i>   | 4 to 8 min. per lb.   | Place unwrapped meat in cooking dish. Turn over after first half of time and shield warm areas with foil. After second half of time, separate pieces with table knife. Let stand to complete defrosting.  |
| <b>Poultry</b><br><i>Chicken, broiler-fryer, cut up (2½ to 3 lbs.)</i><br><i>Chicken, whole (2½ to 3 lbs.)</i><br><i>Cornish hen</i><br><i>Turkey breast (4 to 6 lbs.)</i> | 14 to 20 min.<br>20 to 25 min.<br>7 to 13 min. per lb.<br>3 to 8 min. per lb. | Place wrapped chicken in dish. Unwrap and turn over after first half of time. After second half of time, separate pieces and place in cooking dish. Microwave 2 to 4 minutes more, if necessary. Let stand a few minutes to finish defrosting.<br>Place wrapped chicken in dish. After half the time, unwrap and turn chicken over. Shield warm areas with foil. To complete defrosting, run cold water in the cavity until giblets can be removed.<br>Place unwrapped hen in the oven breast-side-up. Turn over after first half of time. Run cool water in the cavity until giblets can be removed.<br>Place unwrapped breast in microwave-safe dish breast-side-down. After first half of time, turn breast-side-up and shield warm areas with foil. Defrost for second half of time. Let stand 1 to 2 hours in refrigerator to complete defrosting. |



Use only with prepackaged microwave popcorn weighing 1.75 to 3.5 ounces.

## Popcorn

To use the **Popcorn** feature:

- 1** Follow package instructions, using **Time Cook** if the package is less than 1.75 ounces or larger than 3.5 ounces. Place the package of popcorn in the center of the microwave.
- 2** Press **POPCORN** once for a 3.5 ounce package of popcorn, twice for a 3.0 ounce package or three times for a 1.75 ounce package. The oven starts immediately.



## Reheat

The **Reheat** feature reheats 12 or 15 ounce servings of many previously cooked foods.

Press **REHEAT** once to select 12 ounces or twice to select 15 ounces. The oven starts immediately.



## Beverage

To use the **Beverage** feature:

Press **BEVERAGE** once for 1 cup, twice for 2 cups or three times for 3 cups.

*Drinks heated with the Beverage feature may be very hot. Remove the container with care.*



## Frozen Pizza

To use the **Frozen Pizza** feature:

- 1** Follow package instructions, using **Time Cook** if the pizza is less than 7 ounces or larger than 14 ounces.
- 2** Press **FROZEN PIZZA** once for a 7 ounce pizza or twice for a 14 ounce pizza. The oven starts immediately.



EXPRESS COOK



## About the convenience features.

### Cook

The **Cook** feature automatically sets the cooking times and power levels for a variety of foods.

**1** Press **COOK** repeatedly to select food type 1–5.

**2** Press **START**.

### Cook Guide

| <b>Food Type</b>           | <b>Weight</b>                  | <b>Comments</b>  |
|----------------------------|--------------------------------|--|
| <b>1 Canned Vegetables</b> | 1 can<br>(14 to 16 oz.)        | Use microwave-safe casserole or bowl. Cover with lid or vented plastic wrap.   |
| <b>2 Soup</b>              | 12 oz.                         | Cover with lid or vented plastic wrap.   |
| <b>3 Potatoes</b>          | 4 potatoes<br>8 to 10 oz. each | Pierce skin with fork. Place potatoes on the turntable.  |
| <b>4 Fresh Vegetables</b>  | 16 oz.                         | Use microwave-safe casserole or bowl. Add 2 tablespoons water for each serving. Cover with lid or vented plastic wrap.     |
| <b>5 Frozen Vegetables</b> | 16 oz.                         | Use microwave-safe casserole or bowl. Follow package instructions for adding water. Cover with lid or vented plastic wrap. |



### Auto Defrost

Use **Auto Defrost** for meat, poultry and fish weighing up to 2.5 pounds. Use **Time Defrost** for most other frozen foods.

**Auto Defrost** automatically sets the defrosting times and power levels to give even defrosting results for meats, poultry and fish.

**1** Press **AUTO DEFROST** repeatedly to select 1 to 2.5 pounds.

**2** Press **START**.

(**Time Defrost** is explained in the *About the time features* section.)

There is a handy guide located on the inside front of the oven.

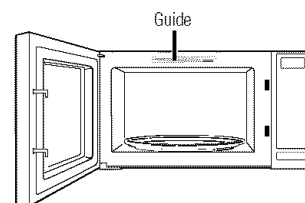

- Remove meat from package and place on microwave-safe dish.
- When the oven signals, turn the food over. Remove defrosted meat or shield warm areas with small pieces of foil.
- After defrosting, most meats need to stand 5 minutes to complete defrosting. Large roasts should stand for about 30 minutes.



## About the other features.



CLOCK

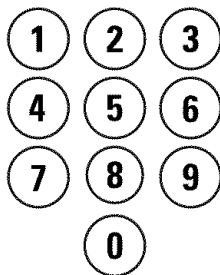

### Clock

Press to enter the time of day.

- 1** Press **CLOCK** once to select 12 hour time or twice to select 24 hour time.
- 2** Enter time of day.
- 3** Press **CLOCK**.

PAUSE  
CLEAR

EXPRESS COOK

START

### Pause/Clear

In addition to cancelling selections, **PAUSE/CLEAR** allows you to stop cooking without opening the door or clearing the display. Press **START** to restart the oven.

PAUSE  
CLEAR

### Child Lock-Out

You may lock the control panel to prevent the microwave from being accidentally started or used by children.

To lock or unlock the controls, press and hold **PAUSE/CLEAR** for about three seconds. When the control panel is locked, the lock indicator will be lit.

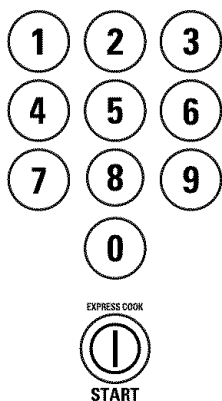

## Kitchen Timer

*This pad performs three functions:*

- It operates as a minute timer.
- It can be set to delay cooking.
- It can be used as a hold setting after defrosting.

### How to Use as a Minute Timer

The **Kitchen Timer** operates without microwave energy.

- 1** Press **KITCHEN TIMER**.
- 2** Enter the amount of time you want to count down.
- 3** Press **START**. When the time is up, the timer will signal.

### How to Use to Delay the Start of Cooking

You can set the microwave to delay the start of cooking up to 99 minutes and 99 seconds.

- 1** Press **KITCHEN TIMER**.
- 2** Enter the amount of time to delay the start of cooking.
- 3** Press **POWER LEVEL**. Change power level if you don't want full power. (Press **POWER LEVEL** repeatedly to select a desired power level.)
- 4** Enter the amount of cooking time.
- 5** Press **START**.

The timer will begin counting down to zero and cooking will then begin.

### How to Use to Set a Holding Time

- 1** Press **AUTO DEFROST** and select food weight, or press **TIME DEFROST** and enter defrosting time.
- 2** Press **KITCHEN TIMER**.
- 3** Enter the amount of time you want the oven to hold.
- 4** Press **START**.

The oven will begin defrosting. After defrosting is complete, the holding time will count down.

## ***Microwave terms.***

---

| <b><i>Term</i></b>          | <b><i>Definition</i></b>  |
|-----------------------------|---|
| <b><i>Arcing</i></b>        | Arcing is the microwave term for sparks in the oven. Arcing is caused by: <ul style="list-style-type: none"><li>■ metal or foil touching the side of the oven.</li><li>■ foil that is not molded to food (upturned edges act like antennas).</li><li>■ metal such as twist-ties, poultry pins, gold-rimmed dishes.</li><li>■ recycled paper towels containing small metal pieces.</li></ul> |
| <b><i>Covering</i></b>      | Covers hold in moisture, allow for more even heating and reduce cooking time. Venting plastic wrap or covering with wax paper allows excess steam to escape.  |
| <b><i>Shielding</i></b>     | In a regular oven, you shield chicken breasts or baked foods to prevent over-browning. When microwaving, you use small strips of foil to shield thin parts, such as the tips of wings and legs on poultry, which would cook before larger parts.  |
| <b><i>Standing Time</i></b> | When you cook with regular ovens, foods such as roasts or cakes are allowed to stand to finish cooking or to set. Standing time is especially important in microwave cooking. Note that a microwaved cake is not placed on a cooling rack.  |
| <b><i>Venting</i></b>       | After covering a dish with plastic wrap, you vent the plastic wrap by turning back one corner so excess steam can escape.   |

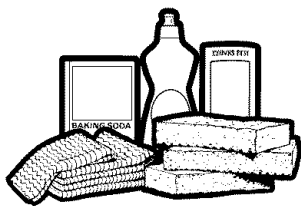

## Helpful Hints

An occasional thorough wiping with a solution of baking soda and water keeps the inside fresh.

*Unplug the cord before cleaning any part of this oven.*

## How to Clean the Inside

### Walls, Floor, Inside Window, Metal and Plastic Parts on the Door

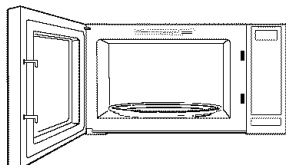

Some spatters can be removed with a paper towel; others may require a damp cloth. Remove greasy spatters with a sudsy cloth, then rinse with a damp cloth. Do not use abrasive cleaners or sharp utensils on oven walls.

*To clean the surface of the door and the surface of the oven that come together upon closing, use only mild, nonabrasive soaps or detergents using a sponge or soft cloth. Rinse with a damp cloth and dry.*

*Never use a commercial oven cleaner on any part of your microwave.*

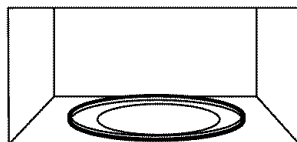

### Removable Turntable and Turntable Support

To prevent breakage, do not place the turntable into water just after cooking. Wash it carefully in warm, sudsy water or in the dishwasher. The turntable and support can be broken if dropped. Remember, do not operate the oven without the turntable and support in place.

## How to Clean the Outside

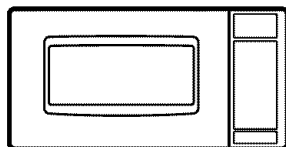

*Do not use cleaners containing ammonia or alcohol on the microwave oven. Ammonia or alcohol can damage the appearance of the microwave.*

### Case

Clean the outside of the microwave with a sudsy cloth. Rinse with a damp cloth and then dry. Wipe the window clean with a damp cloth.

### Control Panel and Door

Wipe with a damp cloth. Dry thoroughly. Do not use cleaning sprays, large amounts of soap and water, abrasives or sharp objects on the panel—they can damage it. Some paper towels can also scratch the control panel.

### Door Surface

It is important to keep the area clean where the door seals against the microwave. Use only mild, non-abrasive detergents applied with a clean sponge or soft cloth. Rinse well.

### Power Cord

If the cord becomes soiled, unplug and wash with a damp cloth. For stubborn spots, sudsy water may be used, but be certain to rinse with a damp cloth and dry thoroughly before plugging cord into outlet.

### Stainless Steel (on some models)

*Do not use a steel-wood pad; it will scratch the surface.*

To clean the stainless steel surface, use a hot, damp cloth with a mild detergent suitable for stainless steel surfaces. Use a clean, hot, damp cloth to remove soap. Dry with a dry, clean cloth. Always scrub lightly in the direction of the grain.

# Troubleshooting Tips.

Safety Instructions

| <i>Problem</i>  | <i>Possible Causes</i>   | <i>What To Do</i>  |
|---|--|--|
| <i>Oven will not start</i>                            | A fuse in your home may be blown or the circuit breaker tripped.                                 | • Replace fuse or reset circuit breaker.   |
|   | Power surge.   | • Unplug the microwave oven, then plug it back in.                                 |
|   | Plug not fully inserted into wall outlet.  | • Make sure the 3-prong plug on the oven is fully inserted into wall outlet.       |
|   | Door not securely closed.  | • Open the door and close securely.  |
| <i>Control panel lighted, yet oven will not start</i> | Door not securely closed.  | • Open the door and close securely.  |
|   | <b>START</b> pad not pressed after entering cooking selection.                                   | • Press <b>START</b> .   |
|   | Another selection entered already in oven and <b>PAUSE/CLEAR</b> pad not pressed to cancel it.   | • Press <b>PAUSE/CLEAR</b> .   |
| <i>Microwave oven control will not work</i>           | <b>PAUSE/CLEAR</b> was pressed accidentally.   | • Reset cooking program and press <b>START</b> .                                   |
|   | The control has been locked. (When the control panel is locked, the lock indicator will be lit.) | • Press and hold <b>PAUSE/CLEAR</b> for about three seconds to unlock the control. |

Operating Instructions

Troubleshooting Tips

Consumer Support

## **Things That Are Normal With Your Microwave Oven**

- Steam or vapor escaping from around the door.
- Light reflection around door or outer case.
- Dimming oven light and change in the blower sound at power levels other than high.
- Dull thumping sound while oven is operating.
- TV/radio interference might be noticed while using the microwave. Similar to the interference caused by other small appliances, it does not indicate a problem with the microwave. Plug the microwave into a different electrical circuit, move the radio or TV as far away from the microwave as possible, or check the position and signal of the TV/radio antenna.

## GE Service Protection Plus™

GE, a name recognized worldwide for quality and dependability, offers you Service Protection Plus™—comprehensive protection on all your appliances—**No Matter What Brand!**

**Benefits Include:**

- Backed by GE
- All brands covered
- Unlimited service calls
- All parts and labor costs included
- No out-of-pocket expenses
- No hidden deductibles
- One 800 number to call

***We'll Cover Any Appliance.  
Anywhere. Anytime.\****

You will be completely satisfied with our service protection or you may request your money back on the remaining value of your contract. No questions asked. It's that simple.

Protect your refrigerator, dishwasher, washer and dryer, range, TV, VCR and much more—**any brand!** Plus there's no extra charge for emergency service and low monthly financing is available. Even icemaker coverage and food spoilage protection is offered. You can rest easy, knowing that all your valuable household products are protected against expensive repairs.

Place your confidence in GE and call us in the U.S. toll-free at **800.626.2224** for more information.

\*All brands covered, up to 20 years old, in the continental U.S.

 Cut here

Please place in envelope and mail to:

***General Electric Company***  
**Warranty Registration Department**  
**P.O. Box 32150**  
**Louisville, KY 40232-2150**



# GE Microwave Oven Warranty.



All warranty service provided by our Factory Service Centers, or an authorized Customer Care® technician. To schedule service, on-line, 24 hours a day, visit us at [ge.com](http://ge.com), or call 800.GE.CARES (800.432.2737). Please have serial and model numbers available when calling for service.

Staple your receipt here. Proof of the original purchase date is needed to obtain service under the warranty.

| For The Period Of:  | GE Will Replace:   |
|---|--|
| <b>One Year</b><br>From the date of the original purchase | <b>Any part</b> of the microwave oven which fails due to a defect in materials or workmanship. During this <b>limited one-year warranty</b> , GE will also provide, <b>free of charge</b> , all labor and related service to replace the defective part. |

**For the above limited warranty:** To avoid any trip charges, you must take the microwave oven to a General Electric Customer Care® servicer and pick it up following service. In-home service is also available, but you must pay for the service technician's travel costs to your home.

## What GE Will Not Cover:

- Service trips to your home to teach you how to use the product.
- Improper installation, delivery or maintenance.
- Product not accessible to provide required service.
- Failure of the product or damage to the product if it is abused, misused (for example, cavity arcing from wire rack or metal/foil), or used for other than the intended purpose or used commercially.
- Replacement of house fuses or resetting of circuit breakers.
- Damage to the product caused by accident, fire, floods or acts of God.
- Incidental or consequential damage caused by possible defects with this appliance.
- Damage caused after delivery.

**EXCLUSION OF IMPLIED WARRANTIES—Your sole and exclusive remedy is product repair as provided in this Limited Warranty. Any implied warranties, including the implied warranties of merchantability or fitness for a particular purpose, are limited to one year or the shortest period allowed by law.**

This warranty is extended to the original purchaser and any succeeding owner for products purchased for home use within the USA. If the product is located in an area where service by a GE Authorized Servicer is not available, you may be responsible for a trip charge or you may be required to bring the product to an Authorized GE Service Location for service. In Alaska, the warranty excludes the service calls to your home.

Some states do not allow the exclusion or limitation of incidental or consequential damages. This warranty gives you specific legal rights, and you may also have other rights which vary from state to state. To know what your legal rights are, consult your local or state consumer affairs office or your state's Attorney General.

**Warrantor: General Electric Company, Louisville, KY 40225**



## Consumer Support

---



### GE Appliances Website

**ge.com**

Have a question or need assistance with your appliance? Try the GE Appliances Website 24 hours a day, any day of the year! For greater convenience and faster service, you can now download Owner's Manuals, order parts, catalogs, or even schedule service on-line. You can also "Ask Our Team of Experts™" your questions, and so much more...

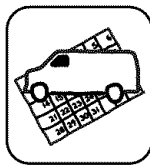

### Schedule Service

**ge.com**

Expert GE repair service is only one step away from your door. Get on-line and schedule your service at your convenience 24 hours any day of the year! Or call 800.GE.CARES (800.432.2737) during normal business hours.

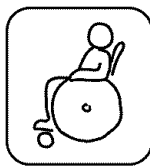

### Real Life Design Studio

**ge.com**

GE supports the Universal Design concept—products, services and environments that can be used by people of all ages, sizes and capabilities. We recognize the need to design for a wide range of physical and mental abilities and impairments. For details of GE's Universal Design applications, including kitchen design ideas for people with disabilities, check out our Website today. For the hearing impaired, please call 800.TDD.GEAC (800.833.4322).



### Extended Warranties

**ge.com**

Purchase a GE extended warranty and learn about special discounts that are available while your warranty is still in effect. You can purchase it on-line anytime, or call 800.626.2224 during normal business hours. GE Consumer Home Services will still be there after your warranty expires.

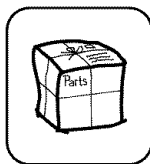

### Parts and Accessories

**ge.com**

Individuals qualified to service their own appliances can have parts or accessories sent directly to their homes (VISA, MasterCard, and Discover cards are accepted). Order on-line today, 24 hours every day or by phone at 800.626.2002 during normal business hours.

**Instructions contained in this manual cover procedures to be performed by any user. Other servicing generally should be referred to qualified service personnel. Caution must be exercised, since improper servicing may cause unsafe operation.**



### Contact Us

**ge.com**

If you are not satisfied with the service you receive from GE, contact us on our Website with all the details including your phone number, or write to: General Manager, Customer Relations  
GE Appliances, Appliance Park  
Louisville, KY 40225



### Register Your Appliance

**ge.com**

Register your new appliance on-line—at your convenience! Timely product registration will allow for enhanced communication and prompt service under the terms of your warranty, should the need arise. You may also mail in the pre-printed registration card included in the packing material.