

This Owner's Manual is provided and hosted by [Appliance Factory Parts](#).

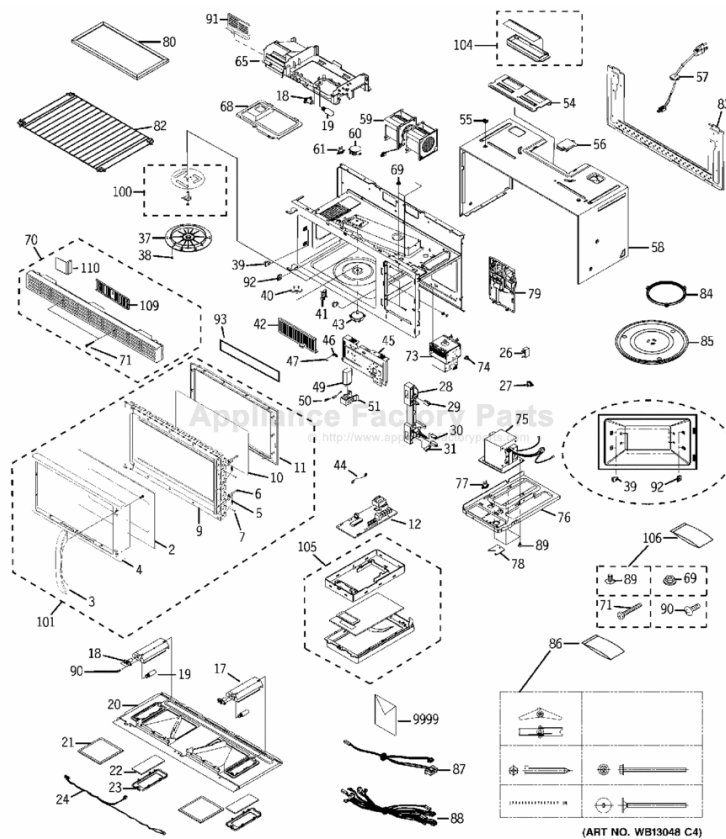

# GE JVM1440BH03 Owner's Manual

[Shop genuine replacement parts for GE JVM1440BH03](#)



[Find Your GE Microwave Parts - Select From 3055 Models](#)

----- Manual continues below -----



Models: JVM1430  
 JVM1440  
 JVM1441  
 JVM1443

# Spacemaker Microwave Oven

## Owner's Manual

	<b>Important Safety Information</b>	<b>2</b>
	<i>Precautions to Avoid Possible Exposure to Excessive Microwave Energy</i>	2
	<i>Special Notes About Microwaving</i>	5

	<b>Operating Instructions</b>	<b>10</b>
	<i>Features of Your Microwave</i>	10
	<i>The Controls on Your Microwave</i>	11
	<i>Time Cooking</i>	14
	<i>Automatic Cooking</i>	20
	<i>Other Features</i>	24
	<i>Oven Shelf</i>	29

	<b>Helpful Information</b>	<b>30</b>
	<i>Microwave Terms</i>	30
	<i>Care and Cleaning</i>	31

	<b>If Something Goes Wrong</b>	<b>36</b>
	<i>Before You Call For Service</i>	36
	<i>GE Service Numbers</i>	38
	<i>Warranty</i>	Back Cover

**Write the model and serial numbers here:**

**Model#** \_\_\_\_\_

**Serial#** \_\_\_\_\_

Find these numbers on a label inside the oven.

[ge.com](http://ge.com)

DE68-62382B  
 49-40473

01-06 JR



## IMPORTANT SAFETY INFORMATION

*READ ALL SAFETY  
INFORMATION BEFORE USING*

### FOR YOUR SAFETY

#### **WARNING!**

*For your safety, the information in this manual must be followed to minimize the risk of fire or explosion, electric shock, or to prevent property damage, personal injury, or loss of life.*



#### **PRECAUTIONS TO AVOID POSSIBLE EXPOSURE TO EXCESSIVE MICROWAVE ENERGY**

For your safety, the information in this manual must be followed to minimize the risk of fire or explosion or to prevent property damage, personal injury or loss of life.

**Do Not Attempt**

to operate this oven with the door open since open-door operation can result in harmful exposure to microwave energy. It is important not to defeat or tamper with the safety interlocks.

**Do Not Place** any object between the oven front face and the door or allow soil or cleaner residue to accumulate on sealing surfaces.

**Do Not Operate** the oven if it is damaged. It is particularly important that the oven door close properly and that there is no damage to the:

- 1** door (bent),
- 2** hinges and latches (broken or loosened),
- 3** door seals and sealing surfaces.

**The Oven Should Not** be adjusted or repaired by anyone except properly qualified service personnel.



## **⚠ WARNING**

*When using electrical appliances, basic safety precautions should be followed, including the following:*

## **SAFETY PRECAUTIONS**

*This microwave oven is intended for household use and is UL listed for installation over electric and gas ranges.*

*This microwave oven is not approved or tested for marine use.*

- Read and follow the specific “Precautions to Avoid Possible Exposure to Excessive Microwave Energy” on page 2.
- This appliance must be grounded. Connect only to properly grounded outlet. See Grounding Instructions section on page 9.
- Do not mount this appliance over a sink.
- Install or locate this appliance only in accordance with the provided Installation Instructions.
- This over-the-range oven was designed for use over ranges no wider than 36". It may be installed over both gas and electric cooking equipment.
- Do not operate this appliance if it has a damaged power cord or plug, if it is not working properly, or if it has been damaged or dropped. If the power cord is damaged, it must be replaced by General Electric Service or an authorized service agent using a power cord from General Electric.
- Do not cover or block any openings on the appliance.
- Use this appliance only for its intended use as described in this manual. Do not use corrosive chemicals or vapors in this appliance. This microwave oven is specifically designed to heat, dry or cook food, and is not intended for laboratory or industrial use.



## **IMPORTANT SAFETY INFORMATION**

### ***READ ALL SAFETY INFORMATION BEFORE USING***

- Do not store this appliance outdoors. Do not use this product near water—for example, in a wet basement, near a swimming pool, near a sink or in similar locations.
- Keep power cord away from heated surfaces.
- Do not immerse power cord or plug in water.
- To reduce the risk of fire in the oven cavity:
  - Do not overcook food. Carefully attend appliance when paper, plastic or other combustible materials are placed inside the oven while cooking.
  - Remove wire twist-ties and metal handles from paper or plastic containers before placing them in the oven.
  - Do not use the oven for storage purposes. Do not leave paper products, cooking utensils or food in the oven when not in use.
  - If materials inside oven ignite, keep the oven door closed, turn the oven off and disconnect the power cord, or shut off power at the fuse or circuit breaker panel. If the door is opened, the fire may spread.
  - Do not use the Sensor Features twice in succession on the same food portion. If food is under cooked after the first countdown, use **Time Cook** for additional cooking time.
- See door surface cleaning instructions in the Care and Cleaning section(s) of this manual.
- This appliance must only be serviced by qualified service personnel. Contact nearest authorized service facility for examination, repair or adjustment.
- As with any appliance, close supervision is necessary when used by children.
- Do not store anything directly on top of the microwave oven surface when the microwave oven is in operation.

4 ***SAVE THESE INSTRUCTIONS***



## SPECIAL NOTES ABOUT MICROWAVING

### ARCING

*If you see arcing, press the CLEAR/OFF pad and correct the problem.*

Arcing is the microwave term for sparks in the oven. Arcing is caused by:

- The metal shelf (if included) not installed correctly so it touches the microwave wall.
- The temperature probe (if included) in the microwave but not inserted in the food.
- Metal or foil touching the side of the oven.
- Foil not molded to food (upturned edges act like antennas).
- Metal, such as twist-ties, poultry pins or gold-rimmed dishes, in the microwave.
- Recycled paper towels containing small metal pieces being used in the microwave.

### FOODS

- Do not pop popcorn in your microwave oven unless in a special microwave popcorn accessory or unless you use popcorn labeled for use in microwave ovens.
- Some products such as whole eggs and sealed containers—for example, closed jars—are able to explode and should not be heated in this microwave oven. Such use of the microwave oven could result in injury.
- Do not boil eggs in a microwave oven. Pressure will build up inside egg yolk and will cause it to burst, possibly resulting in injury.
- Operating the microwave with no food inside for more than a minute or two may cause damage to the oven and could start a fire. It increases the heat around the magnetron and can shorten the life of the oven.
- Foods with unbroken outer “skin” such as potatoes, hot dogs, sausages, tomatoes, apples, chicken livers and other giblets, and egg yolks should be pierced to allow steam to escape during cooking.



## **IMPORTANT SAFETY INFORMATION**

### *SPECIAL NOTES ABOUT MICROWAVING*

#### **SAFETY FACT**

##### ***SUPERHEATED WATER***

*Liquids, such as water, coffee or tea, are able to be overheated beyond the boiling point without appearing to be boiling. Visible bubbling or boiling when the container is removed from the microwave oven is not always present. THIS COULD RESULT IN VERY HOT LIQUIDS SUDDENLY BOILING OVER WHEN THE CONTAINER IS DISTURBED OR A SPOON OR OTHER UTENSIL IS INSERTED INTO THE LIQUID.*

To reduce the risk of injury to persons:

- Do not overheat the liquid.
- Stir the liquid both before and halfway through heating it.
- Do not use straight-sided containers with narrow necks.
- After heating, allow the container to stand in the microwave oven for a short time before removing the container.
- Use extreme care when inserting a spoon or other utensil into the container.

- Avoid heating baby food in glass jars, even with the lid off. Make sure all infant food is thoroughly cooked. Stir food to distribute the heat evenly. Be careful to prevent scalding when warming formula or breast milk. The container may feel cooler than the milk really is. Always test the milk before feeding the baby.
- Don't defrost frozen beverages in narrow-necked bottles (especially carbonated beverages). Even if the container is opened, pressure can build up. This can cause the container to burst, possibly resulting in injury.
- Hot foods and steam can cause burns. Be careful when opening any containers of hot food, including popcorn bags, cooking pouches and boxes. To prevent possible injury, direct steam away from hands and face.
- Do not overcook potatoes. They could dehydrate and catch fire, causing damage to your oven.
- Cook meat and poultry thoroughly—meat to at least an INTERNAL temperature of 160°F and poultry to at least an INTERNAL temperature of 180°F. Cooking to these temperatures usually protects against foodborne illness.



## MICROWAVE-SAFE COOKWARE

Make sure all cookware used in your microwave oven is suitable for microwaving. Most glass casseroles, cooking dishes, measuring cups, custard cups, pottery or china dinnerware which does not have metallic trim or glaze with a metallic sheen can be used. Some cookware is labeled “suitable for microwaving.”

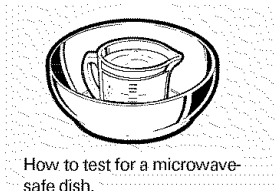

- If you are not sure if a dish is microwave-safe, use this test: Place in the oven both the dish you are testing and a glass measuring cup filled with 1 cup of water—set the measuring cup either in or next to the dish. Microwave 30–45 seconds at high. If the dish heats, it should not be used for microwaving.

If the dish remains cool and only the water in the cup heats, then the dish is microwave-safe.

- If you use a meat thermometer while cooking, make sure it is safe for use in microwave ovens.
- Do not use recycled paper products. Recycled paper towels, napkins and waxed paper can contain metal flecks which may cause arcing or ignite. Paper products containing nylon or nylon filaments should be avoided, as they may also ignite.
- Some styrofoam trays (like those that meat is packaged on) have a thin strip of metal embedded in the bottom. When microwaved, the metal can burn the floor of the oven or ignite a paper towel.
- Do not use the microwave to dry newspapers.
- Not all plastic wrap is suitable for use in microwave ovens. Check the package for proper use.
- Paper towels, waxed paper and plastic wrap can be used to cover dishes in order to retain moisture and prevent spattering. Be sure to vent plastic wrap so steam can escape.
- Cookware may become hot because of heat transferred from the heated food. Pot holders may be needed to handle the cookware.
- “Boilable” cooking pouches and tightly closed plastic bags should be slit, pierced or vented as directed by package. If they are not, plastic could burst during or immediately after cooking, possibly resulting in injury. Also, plastic storage containers should be at least partially uncovered because they form a tight seal. When cooking with containers tightly covered with plastic wrap, remove covering carefully and direct steam away from hands and face.





## IMPORTANT SAFETY INFORMATION

### SPECIAL NOTES ABOUT MICROWAVING

- Use foil only as directed in this manual. When using foil in the microwave oven, keep the foil at least 1" away from the sides of the oven.
  - Plastic cookware—Plastic cookware designed for microwave cooking is very useful, but should be used carefully. Even microwave-safe plastic may not be as tolerant of overcooking conditions as are glass or ceramic materials and may soften or char if subjected to short periods of overcooking. In longer exposures to overcooking, the food and cookware could ignite.
- Follow these guidelines:
- 1** Use microwave-safe plastics only and use them in strict compliance with the cookware manufacturer's recommendations.
  - 2** Do not microwave empty containers.
  - 3** Do not permit children to use plastic cookware without complete supervision.

### THE VENT FAN

The fan will operate automatically under certain conditions (see Automatic Fan feature). Take care to prevent the starting and spreading of accidental cooking fires while the vent fan is in use.

- Clean the underside of the microwave often. Do not allow grease to build up on the microwave or the fan filter.
- In the event of a grease fire on the surface units below the microwave oven, smother a flaming pan on the surface unit by covering the pan completely with a lid, a cookie sheet or a flat tray.
- Use care when cleaning the vent fan filter. Corrosive cleaning agents, such as lye-based oven cleaners, may damage the filter.
- When preparing flaming foods under the microwave, turn the vent fan on.
- Never leave surface units beneath your microwave oven unattended at high heat settings. Boilovers cause smoking and greasy spillovers that may ignite and spread if the microwave vent fan is operating. To minimize automatic fan operation, use adequate sized cookware and use high heat on surface units only when necessary.



## GROUNDING INSTRUCTIONS/OPTIONAL KITS

### GROUNDING INSTRUCTIONS

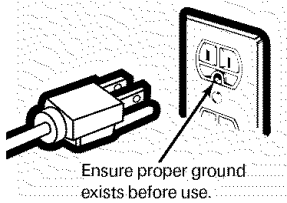

This appliance is equipped with a power cord having a grounding wire with a grounding plug. The plug must be plugged into an outlet that is properly installed and grounded.

Do not, under any circumstances, cut or remove the third (ground) prong from the power cord.

Do not use an adapter plug with this appliance.

Do not use an extension cord with this appliance. If the power cord is too short, have a qualified electrician or service technician install an outlet near the appliance.

For best operation, plug this appliance into its own electrical outlet to prevent flickering of lights, blowing of fuse or tripping of circuit breaker.

### **⚠ WARNING**

**Improper use of the grounding plug can result in a risk of electric shock.**

This appliance must be grounded. In the event of an electrical short circuit, grounding reduces the risk of electric shock by providing an escape wire for the electric current.

Consult a qualified electrician or service technician if the grounding instructions are not completely understood, or if doubt exists as to whether the appliance is properly grounded.

If the outlet is a standard 2-prong wall outlet, it is your personal responsibility and obligation to have it replaced with a properly grounded 3-prong wall outlet.

### Optional Kits

**Filler Panel Kits**  
**JX40WH—White**  
**JX41—Black**

When replacing a 36" range hood, filler panel kits fill in the additional width to provide a custom built-in appearance.

For installation between cabinets only; not for end-of-cabinet installation. Each kit contains two 3"-wide filler panels.

**JX81A—Recirculating Charcoal Filter Kit**

Filter kits are used when the microwave oven cannot be vented to the outside.

Available at extra cost from your GE supplier.

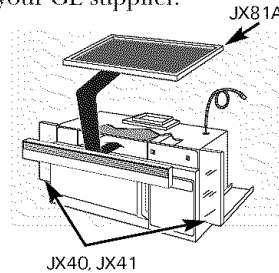

# Operating Instructions

## Features of Your Microwave

(Throughout this manual, features and appearance may vary from your model.)

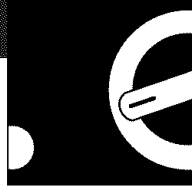

### Features

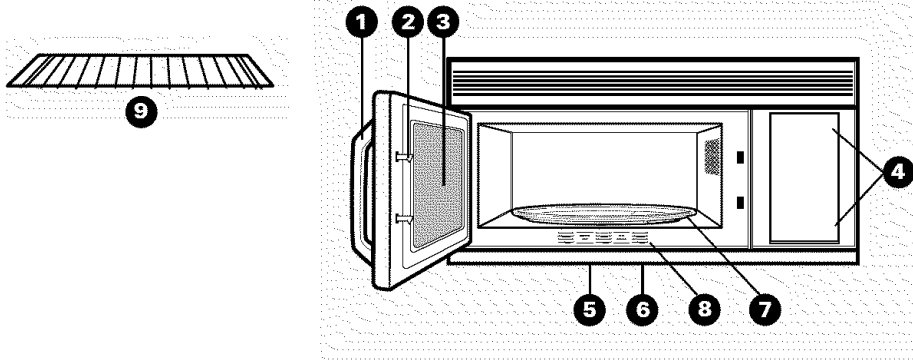

- 1 Door Handle.** Pull to open the door. The door must be securely latched for the microwave to operate.
- 2 Door Latches.**
- 3 Window with Metal Shield.** Screen allows cooking to be viewed while keeping microwaves confined in the oven.
- 4 Touch Control Panel.**
- 5 Cooktop Light.**
- 6 Grease Filter.**
- 7 Removable Turntable.** Turntable and support **must** be in place when using the oven. The turntable may be removed for cleaning.
- 8 Convenience Guide.**  
**NOTE:** Rating plate, oven vent(s) and oven light are located on the inside walls of the microwave oven.
- 9 Shelf (on some models).** Lets you microwave several foods at once. Food microwaves best when placed directly on the turntable.



# Quick Start

## The Controls on Your Microwave Oven

(Throughout this manual, features and appearance may vary from your model.)

You can microwave by time, temperature, or with the convenience features.

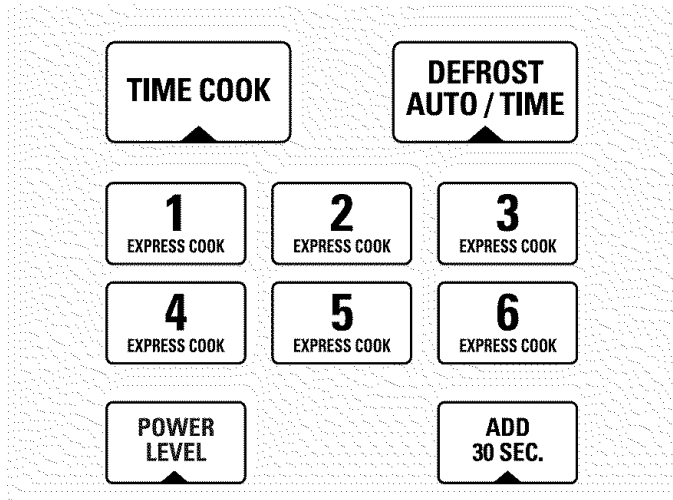

### 1 Time Features

#### Time Cooking

Press	Enter
TIME COOK I & II (Press once or twice)	Amount of cooking time.
DEFROST AUTO/TIME (Press twice)	Amount of defrosting time.
EXPRESS COOK	Starts immediately!
POWER LEVEL	Power level 1–10.
ADD 30 SEC	Starts immediately!



# Quick Start

### HELP (on some models)

Press this pad and any feature pad for usage instructions and tips.

### GUIDE ON MICROWAVE

Before you begin, check the guide located on the inside front of the oven when you open the door.

### GUIDES IN BOOK

- Cooking
- Time Defrost
- Reheat

POPCORN

BEVERAGE

REHEAT

DEFROST  
AUTO / TIME

## 2

### Convenience Features

<i>Press</i>	<i>Enter</i>	<i>Option</i>
<b>POPCORN</b>	Starts immediately!	more /less time serving size
<b>BEVERAGE</b>	Starts immediately!	serving size
<b>REHEAT</b>	(See Reheat Guide)	serving size
<b>DEFROST AUTO/TIME</b> (Press once)	Food weight	



## Changing Power Levels

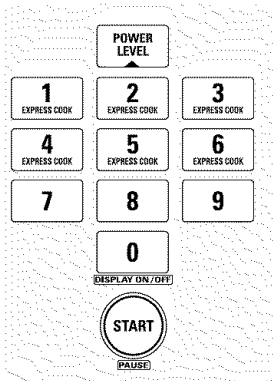

### How to Change the Power Level

The power level may be entered or changed immediately after entering the feature time for TIME COOK, TIME DEFROST or EXPRESS COOK. The power level may also be changed during time countdown.

- 1 Press **TIME COOK** or **select Time Defrost.**
- 2 Enter cooking or defrosting time.
- 3 Press **POWER LEVEL.**
- 4 Select desired power level 1–10.
- 5 Press **START.**

Variable power levels add flexibility to microwave cooking. The power levels on the microwave oven can be compared to the surface units on a range. High (power level 10) or full power is the fastest way to cook and gives you 100% power. Each power level gives you microwave energy a certain percent of the time. Power level 7 is microwave energy 70% of the time. Power level 3 is energy 30% of the time.

A high setting (10) will cook faster but food may need more frequent stirring, rotating or turning over. Most cooking will be done on High (power level 10). A lower setting will cook more evenly and need less stirring or rotating of the food.

Some foods may have better flavor, texture or appearance if one of the lower settings is used. Use a lower power level when cooking foods that have a tendency to boil over, such as scalloped potatoes.

Rest periods (when the microwave energy cycles off) give time for the food

to “equalize” or transfer heat to the inside of the food. An example of this is shown with power level 3—the defrost cycle. If microwave energy did not cycle off, the outside of the food would cook before the inside was defrosted.

Here are some examples of uses for various power levels:

### Power Level Best Uses

- High 10** Fish, bacon, vegetables, boiling liquids.
- Med-High 7** Gentle cooking of meat and poultry; baking casseroles and reheating.
- Medium 5** Slow cooking and tenderizing such as stews and less tender cuts of meat.
- Low 2 or 3** Defrosting without cooking; simmering; delicate sauces.
- Warm 1** Keeping food warm without overcooking; softening butter.



## Time Features

### Time Cook



- 1 Press TIME COOK.**
- 2 Enter cooking time.**
- 3 Change power level if you don't want full power. (Press POWER LEVEL. Select a desired power level 1-10.)**
- 4 Press START.**

#### Time Cook I

Allows you to microwave for any time up to 99 minutes and 99 seconds.

Power level 10 (High) is automatically set, but you may change it for more flexibility.

You may open the door during Time Cook to check the food. Close the door and press START to resume cooking.

#### Time Cook II

Lets you change power levels automatically during cooking. Here's how to do it:

- 1 Press TIME COOK.**
- 2 Enter the first cook time.**
- 3 Change the power level if you don't want full power. (Press POWER LEVEL. Select a desired power level 1-10.)**
- 4 Press TIME COOK again.**
- 5 Enter the second cook time.**
- 6 Change the power level if you don't want full power. (Press POWER LEVEL. Select a power level 1-10.)**
- 7 Press START.**

At the end of Time Cook I, Time Cook II counts down.



**NOTE: Use power level High (10) unless otherwise noted.**

<b>Vegetable</b>	<b>Amount</b>	<b>Time</b>	<b>Comments</b>
<b>Asparagus</b>			
(fresh spears)	1 lb.	6 to 9 min., Med-High (7)	In 1½-qt. oblong glass baking dish, place 1/4 cup water.
(frozen spears)	10-oz. package	5 to 7 min.	In 1-qt. casserole.
<b>Beans</b>			
(fresh green)	1 lb. cut in half	9 to 11 min.	In 1½-qt. casserole, place 1/2 cup water.
(frozen green)	10-oz. package	6 to 8 min.	In 1-qt. casserole, place 2 tablespoons water.
(frozen lima)	10-oz. package	6 to 8 min.	In 1-qt. casserole, place 1/4 cup water.
<b>Beets</b>			
(fresh, whole)	1 bunch	17 to 21 min.	In 2-qt. casserole, place 1/2 cup water.
<b>Broccoli</b>			
(fresh cut)	1 bunch (1¼ to 1½ lbs.)	7 to 10 min.	In 2-qt. casserole, place 1/2 cup water.
(fresh spears)	1 bunch (1¼ to 1½ lbs.)	9 to 13 min.	In 2-qt. oblong glass baking dish, place 1/4 cup water.
(frozen, chopped)	10-oz. package	5 to 7 min.	In 1-qt. casserole.
(frozen spears)	10-oz. package	5 to 7 min.	In 1-qt. casserole, place 3 tablespoons water.
<b>Cabbage</b>			
(fresh)	1 medium head (about 2 lbs.)	8 to 11 min.	In 1½- or 2-qt. casserole, place 1/4 cup water.
(wedges)		7 to 10 min.	In 2- or 3-qt. casserole, place 1/4 cup water.
<b>Carrots</b>			
(fresh, sliced)	1 lb.	7 to 9 min.	In 1½-qt. casserole, place 1/4 cup water.
(frozen)	10-oz. package	5 to 7 min.	In 1-qt. casserole, place 2 tablespoons water.
<b>Cauliflower</b>			
(flowerets)	1 medium head	9 to 14 min.	In 2-qt. casserole, place 1/2 cup water.
(fresh, whole)	1 medium head	10 to 17 min.	In 2-qt. casserole, place 1/2 cup water.
(frozen)	10-oz. package	5 to 7 min.	In 1-qt. casserole, place 2 tablespoons water.





# Operating Instructions

## Cooking Guide for Time Cook I & II

<b>Vegetable</b>	<b>Amount</b>	<b>Time</b>	<b>Comments</b>
<b>Corn</b> (frozen kernel)	10-oz. package	5 to 7 min.	In 1-qt. casserole, place 2 tablespoons water.
<b>Corn on the cob</b> (fresh)	1 to 5 ears	3 to 4 min. per ear	In 2-qt. oblong glass baking dish, place corn. If corn is in husk, use no water; if corn has been husked, add 1/4 cup water. Rearrange after half of time.
(frozen)	1 ear 2 to 6 ears	5 to 6 min. 3 to 4 min. per ear	Place in 2-qt. oblong glass baking dish. Cover with vented plastic wrap. Rearrange after half of time.
<b>Mixed vegetables</b> (frozen)	10-oz. package	5 to 7 min.	In 1-qt. casserole, place 3 tablespoons water.
<b>Peas</b> (fresh, shelled)	2 lbs. unshelled	9 to 12 min.	In 1-qt. casserole, place 1/4 cup water.
(frozen)	10-oz. package	5 to 7 min.	In 1-qt. casserole, place 2 tablespoons water.
<b>Potatoes</b> (fresh, cubed, white)	4 potatoes (6 to 8 oz. each)	9 to 12 min.	Peel and cut into 1 inch cubes. Place in 2-qt. casserole with 1/2 cup water. Stir after half of time.
(fresh, whole, sweet or white)	1 (6 to 8 oz.)	3 to 4 min.	Pierce with cooking fork. Place in center of the oven. Let stand 5 minutes.
<b>Spinach</b> (fresh)	10 to 16 oz.	5 to 7 min.	In 2-qt. casserole, place washed spinach.
(frozen, chopped and leaf)	10-oz. package	5 to 7 min.	In 1-qt. casserole, place 3 tablespoons water.
<b>Squash</b> (fresh, summer and yellow)	1 lb. sliced	5 to 7 min.	In 1½-qt. casserole, place 1/4 cup water.
(winter, acorn butternut)	1 to 2 squash (about 1 lb. each)	8 to 11 min.	Cut in half and remove fibrous membranes. In 2-qt. oblong glass baking dish, place squash cut-side-down. Turn cut-side-up after 4 minutes.



**Time Defrost**

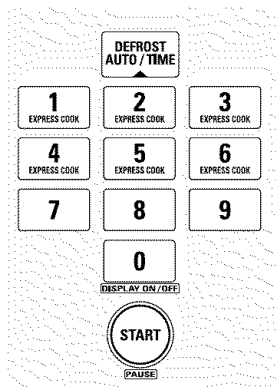

- 1 Press DEFROST AUTO/TIME twice.**
  - 2 Enter defrosting time.**
  - 3 Press START.**
  - 4 Turn food over when the oven signals.**
  - 5 Press START.**
- (Auto Defrost explained in the section on Convenience Features.)*

Allows you to defrost for the length of time you select. See the Defrosting Guide for suggested times.

Power level 3 is automatically set, but you may change this for more flexibility. You may defrost small items more quickly by raising the power level after entering the time. However, they will need more frequent attention than usual.

Power level 7 cuts the total defrosting time in about half; power level 10 cuts the total time to approximately 1/3. Rotate or stir food frequently.

At one half of selected defrosting time, the oven signals TURN. At this time, turn food over and break apart or rearrange pieces for more even defrosting. Shield any warm areas with small pieces of foil.

A dull thumping noise may be heard during defrosting. This sound is normal when the oven is not operating at High power.

**Defrosting Tips**

- Foods frozen in paper or plastic can be defrosted in the package. Tightly closed packages should be slit, pierced or vented AFTER food has partially defrosted. Plastic storage containers should be at least partially uncovered.
- Family-size, prepackaged frozen dinners can be defrosted and microwaved. If the food is in a foil container, transfer it to a microwave-safe dish.
- Foods that spoil easily, such as milk, eggs, fish, stuffings, poultry and pork, should not be allowed to sit out for more than one hour after defrosting. Room temperature promotes the growth of harmful bacteria.
- For more even defrosting of larger foods, such as beef, lamb and veal roasts, use Auto Defrost.
- Be sure large meats are completely defrosted before cooking.
- When defrosted, food should be cool but softened in all areas. If still slightly icy, return to the microwave very briefly, or let it stand a few minutes.



# Operating Instructions

## Defrosting Guide

<b>Food</b>	<b>Time</b>	<b>Comments</b>
<b>Breads, Cakes</b>		
<b>Bread, buns or rolls</b> (1 piece)	1 min.	
<b>Sweet rolls</b> (approx. 12 oz.)	3 to 5 min.	
<b>Fish and Seafood</b>		
<b>Fillets, frozen</b> (1 lb.)	6 to 8 min.	Place block in casserole. Turn over and break up after half the time.
<b>Shellfish, small pieces</b> (1 lb.)	5 to 7 min.	
<b>Fruit</b>		
<b>Plastic pouch—1 to 2</b> (10-oz. package)	3 to 6 min.	
<b>Meat</b>		
<b>Bacon</b> (1 lb.)	2 to 5 min.	Place unopened package in oven. Let stand 5 minutes after defrosting.
<b>Franks</b> (1 lb.)	2 to 5 min.	Place unopened package in oven. Microwave just until franks can be separated. Let stand 5 minutes, if necessary, to complete defrosting.
<b>Ground meat</b> (1 lb.)	5 to 7 min.	Turn meat over after half the time.
<b>Roast: beef, lamb, veal, pork</b>	12 to 16 min. per lb.	Use power level 1.
<b>Steaks, chops and cutlets</b>	5 to 7 min. per lb.	Place unwrapped meat in cooking dish. Turn over after half the time and shield warm areas with foil. When finished, separate pieces and let stand to complete defrosting.
<b>Poultry</b>		
<b>Chicken, broiler-fryer cut up</b> (2½ to 3 lbs.)	15 to 19 min.	Place wrapped chicken in dish. Unwrap and turn over after half the time. When finished, separate pieces and microwave 2–4 minutes more, if necessary. Let stand to finish defrosting.
<b>Chicken, whole</b> (2½ to 3 lbs.)	17 to 21 min.	Place wrapped chicken in dish. After half the time, unwrap and turn chicken over. Shield warm areas with foil. Finish defrosting. If necessary, run cold water in the cavity until giblets can be removed.
<b>Cornish hen</b>	7 to 13 min. per lb.	Place unwrapped hen in the oven breast-side-up. Turn over after half the time. Run cool water in the cavity until giblets can be removed.
<b>Turkey breast</b> (4 to 6 lbs.)	5 to 9 min. per lb.	Place unwrapped breast in dish breast-side-down. After half the time, turn over and shield warm areas with foil. Finish defrosting. Let stand 1–2 hours in refrigerator to complete defrosting.



## Express Cook

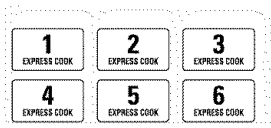

***This is a quick way to set cooking time for 1–6 minutes.***

Press one of the Express Cook pads (from 1 to 6) for 1 to 6 minutes of cooking at power level 10. For example, press the 2 pad for 2 minutes of cooking time.

The power level can be changed as time is counting down. Press POWER LEVEL and enter 1–10.

## Add 30 Seconds



***You can use this feature two ways:***

- It will add 30 seconds to the time counting down each time the pad is pressed.
- It can be used as a quick way to set 30 seconds of cooking time.



## Convenience Features

### Popcorn

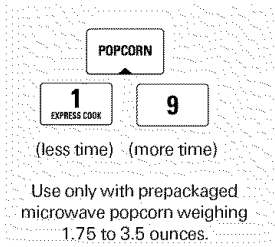

**NOTE:** Do not use the metal shelf when cooking popcorn.

#### **How to Use the Popcorn Feature**

**1** Follow package instructions, using Time Cook if the package is less than 1.75 ounces or larger than 3.5 ounces. Place the package of popcorn in the center of the microwave.

**2** Press POPCORN. The oven starts immediately. Tap POPCORN to select the bag size you are cooking.

#### **How to Adjust the Popcorn Program to Provide a Shorter or Longer Cook Time**

If you find that the brand of popcorn you use underpops or overcooks consistently, you can add or subtract 20 seconds to the automatic popping time.

##### **To add time:**

After pressing POPCORN, press 9 immediately after the oven starts for an extra 20 seconds.

On some models, press 9 again to add another 10 seconds (total 30 seconds additional time).

##### **To subtract time:**

After pressing POPCORN, press 1 immediately after the oven starts for 20 seconds less cooking time.

On some models, press 1 again to reduce cooking time another 10 seconds (total 30 seconds less time).



**Reheat**

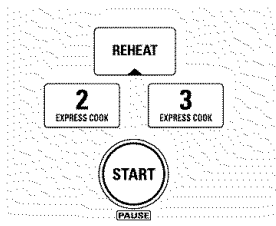

**NOTE:** Do not use the metal shelf when using the Reheat feature.

The Reheat feature reheats servings of many previously cooked foods.

**1** Press REHEAT.

**2** Select food type 1–6 for one serving (see Reheat Guide below). On some models, the oven starts immediately.

**3** Press 2 or 3 to change the serving size.

**4** On some models, press START.

**NOTE:** The serving size may be changed or added after the oven starts. Press number pad 2 or 3. On some models, the serving size for food type 6 cannot be changed.

**Reheat Guide**

Food Type	Comments
<b>1 Pasta</b>	Cover with lid or vented plastic wrap.
<b>2 Meats, casseroles, pizza</b>	Cover with lid or vented plastic wrap.
<b>3 Fruits and vegetables</b>	Cover with lid or vented plastic wrap.
<b>4 Beverages, 8–10 oz.</b>	Works best with wide mouth mug—do not cover.
<b>5 Sauces and gravies</b>	Cover with lid or vented plastic wrap.
<b>6 Plate of leftovers (2 to 3 foods, 4 oz. each)</b>	Cover with vented plastic wrap.



## Convenience Features

### Beverage

The Beverage feature heats servings of any beverage.

Press BEVERAGE. The oven starts immediately.

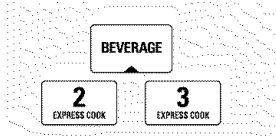

**On some models**, the serving size is automatically set at 1, but can be changed by pressing 2 or 3 right after pressing BEVERAGE.

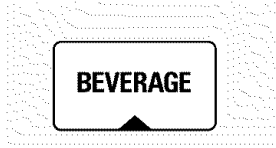

**On model JVM1430 only**, the serving size is automatically set at 4 ounces, but can be changed by tapping BEVERAGE to select 8 or 12 ounces.

**Drinks heated with the Beverage feature may be very hot. Remove the container with care.**



**Auto Defrost**



- 1 Press DEFROST AUTO/TIME once.**
- 2 Using the Conversion Guide at right, enter food weight. For example, press pads 1 and 2 for 1.2 pounds (1 pound, 3 ounces).**
- 3 Press START.**  
(Time Defrost is explained in the Time Features section.)

The Defrost Auto/Time feature gives you two ways to defrost frozen foods. Press DEFROST AUTO/TIME once for Auto Defrost or twice for Time Defrost.

Use Auto Defrost for meat, poultry and fish. Use Time Defrost for most other frozen foods.

Auto Defrost automatically sets the defrosting times and power levels to give even defrosting results for meats, poultry and fish weighing up to six pounds.

There is a handy guide located on the inside front of the oven.

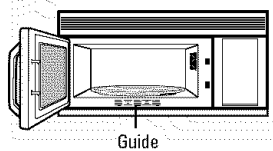

**Conversion Guide**

If the weight of food is stated in pounds and ounces, the ounces must be converted to tenths (.1) of a pound.

<b>Weight of Food in Ounces</b>	<b>Enter Food Weight (tenths of a pound)</b>
1-2	.1
3	.2
4-5	.3
6-7	.4
8	.5
9-10	.6
11	.7
12-13	.8
14-15	.9

- Remove meat from package and place on microwave-safe dish.
- Twice during defrost, the oven signals TURN. At each TURN signal, turn the food over. Remove defrosted meat or shield warm areas with small pieces of foil.
- After defrosting, most meats need to stand 5 minutes to complete defrosting. Large roasts should stand for about 30 minutes.





## Operating Instructions

### Other Features Your Model May Have

#### Help

*(On some models)*

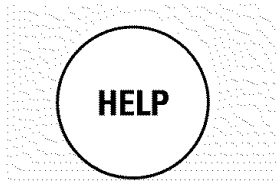

The HELP pad displays feature information and helpful hints. Press HELP, then select a feature pad.

#### Cooking Complete Reminder

To remind you that you have food in the oven, the oven will display "FOOD IS READY" or "END" and beep once a minute until you either open the oven door or press CLEAR/OFF.

#### Clock

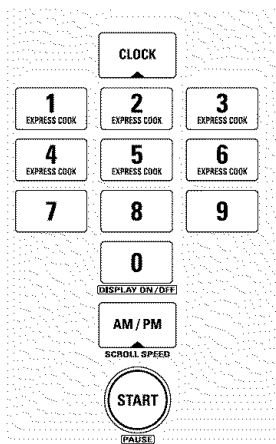

Press to enter the time of day or to check the time of day while microwaving.

- 1** Press CLOCK.
- 2** Enter time of day.
- 3** On some models, select AM or PM.
- 4** Press START or CLOCK.



### Scroll Speed

(On some models)

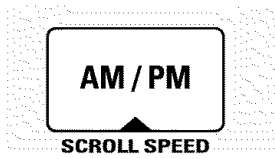

The scroll speed of the display can be changed. Press and hold the AM/PM pad about 3 seconds to bring up the display. Select 1–5 for slow to fast scroll speed.

### Display On/Off

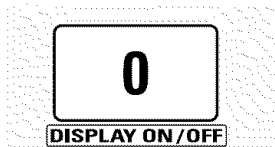

To turn the clock display off, press and hold 0 for about three seconds.

To redisplay the clock, repeat.

### Delay Start

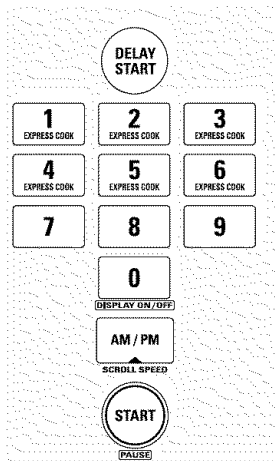

Delay Start allows you to set the microwave to delay cooking up to 24 hours.

- 1 Press DELAY START.
- 2 Enter the time you want the oven to start. (Be sure the microwave clock shows the correct time of day.)
- 3 On some models, select AM or PM.

4 Select any combination of Defrost Auto/Time or Time Cook I & II.

- 5 Press START.

The Delay Start time will be displayed. The oven will automatically start at the delayed time.

The time of day may be displayed by pressing CLOCK.



# Operating Instructions

## Other Features Your Model May Have

### Timer On/Off

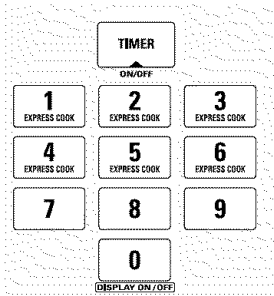

Timer On/Off operates as a minute timer and can be used at any time, even when the oven is operating.

- 1 Press TIMER ON/OFF.
- 2 Enter time you want to count down.
- 3 Press TIMER ON/OFF to start.

When time is up, the oven will signal. To turn off the timer signal, press TIMER ON/OFF.

**NOTE:** The timer indicator will be lit while the timer is operating.

### Start/Pause

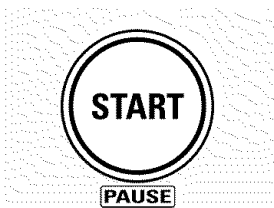

In addition to starting many functions, START/PAUSE allows you to stop cooking without opening the door or clearing the display.

### Reminder

*(On some models)*



The Reminder feature can be used like an alarm clock and can be used at any time, even when the oven is operating. The Reminder time can be set up to 24 hours later.

- 1 Press REMINDER.
- 2 Enter the time you want the oven to remind you. (Be sure the microwave clock shows the correct time of day.)
- 3 On some models, select AM or PM.

4 Press REMINDER. When Reminder signal occurs, press REMINDER to turn it off. The Reminder time may be displayed by pressing REMINDER.

**NOTE:** The REM indicator will remain lit to show that the Reminder is set. To clear the Reminder before it occurs, press REMINDER, then 0. The REM indicator will no longer be lit.



### Child Lock-Out



You may lock the control panel to prevent the microwave from being accidentally started or used by children.

To lock or unlock the controls, press and hold CLEAR/OFF for about 3 seconds. When the control panel is locked, "L" or "LOC" will be displayed to the extreme right.

### Turntable

*(On some models)*



For best cooking results, leave the turntable on. It can be turned off for large dishes. Press TURNTABLE to turn the turntable on or off.

**Sometimes the turntable can become too hot to touch.** Be careful touching the turntable during and after cooking.

### Surface Light



Press to turn the surface light on or off.

On some models, there is a night light option.

Press SURFACE LIGHT **once** for bright light, **twice** for the night light or **three** times to turn the light off.



## Operating Instructions

### Other Features Your Model May Have

#### Beeper Volume

(On some models)



The beeper sound level can be adjusted. Press BEEPER VOLUME. Choose 0–3 for mute to loud.

#### Vent Fan



When the microwave oven is off, you may operate the vent fan:

- 1 Press the Vent Fan pad once for high fan speed.
- 2 Press the Vent Fan pad a second time for low fan speed.
- 3 Press the Vent Fan pad a third time to turn the fan off.

When the microwave is on, the vent fan will automatically turn on at low fan speed, stay on while the microwave is operating and automatically turn off after the microwave goes off if the Vent Fan pad is not pressed.

When the microwave oven is on you may also:

- 1 Press the Vent Fan pad once for high fan speed.
- 2 Press the Vent Fan pad a second time for low fan speed.
- 3 Press the Vent Fan pad a third time to set the fan to turn off automatically after the microwave goes off.

If the vent fan is still operating after the microwave goes off, press the Vent Fan pad until it turns off.

**NOTE:** The vent fan cannot be turned off while the microwave is operating.



**Shelf (on some models)**

**How to Use the Shelf  
When Microwaving**

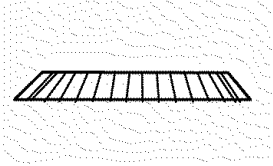

- Make sure the shelf is positioned properly inside the microwave to prevent damage to the oven from arcing.
- Do not use a microwave browning dish on the shelf. The shelf could overheat.
- Do not use the oven with the shelf on the microwave floor. This could damage the microwave.
- Use pot holders when handling the shelf—it may be hot.
- Do not use the shelf when cooking popcorn.
- Do not use the shelf with the Reheat feature.

Food microwaves best when placed on the turntable or on the shelf in the lower position.

Only use the shelf when reheating on more than one level. Do not store the shelf inside the oven cavity.

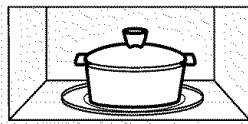

For best results

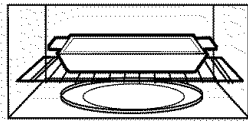

Use the lower shelf supports when cooking one oblong or oversized dish.

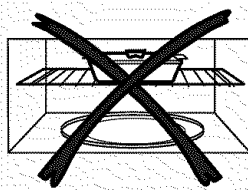

Uneven results

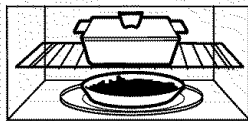

2-level reheating

Use the upper shelf supports for two-level cooking.

**Shelf and Reheating**

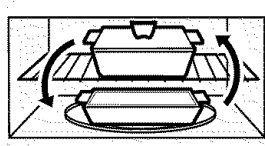

Switch places after 1/2 time.

- To reheat on 2 levels

or

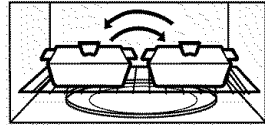

Switch places after 1/2 time.

- To reheat 2 dishes on the lower level:

- 1 Multiply reheat time by 1 1/2.
- 2 Switch places after 1/2 the time.

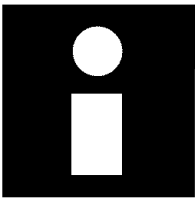

## Helpful Information

### Microwave Terms

<b>Term</b>	<b>Definition</b>
<b>Arcing</b>	<p>Arcing is the microwave term for sparks in the oven. Arcing is caused by:</p> <ul style="list-style-type: none"><li>• the metal shelf being installed incorrectly and touching the microwave walls.</li><li>• metal or foil touching the side of the oven.</li><li>• foil that is not molded to food (upturned edges act like antennas).</li><li>• metal such as twist ties, poultry pins, gold-rimmed dishes.</li><li>• recycled paper towels containing small metal pieces.</li></ul>
<b>Covering</b>	<p>Covers hold in moisture, allow for more even heating and reduce cooking time. Venting plastic wrap or covering with wax paper allows excess steam to escape.</p>
<b>Shielding</b>	<p>In a regular oven, you shield chicken breasts or baked foods to prevent over-browning. When microwaving, you use small strips of foil to shield thin parts, such as the tips of wings and legs on poultry, which would cook before larger parts.</p>
<b>Standing Time</b>	<p>When you cook with regular ovens, foods such as roasts or cakes are allowed to stand to finish cooking or to set. Standing time is especially important in microwave cooking. Note that a microwaved cake is not placed on a cooling rack.</p>
<b>Venting</b>	<p>After covering a dish with plastic wrap, you vent the plastic wrap by turning back one corner so excess steam can escape.</p>



## Helpful Hints

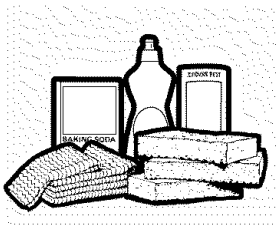

An occasional thorough wiping with a solution of baking soda and water keeps the inside fresh.

**NOTE: Be certain the power is off before cleaning any part of this oven.**

## How to Clean the Inside

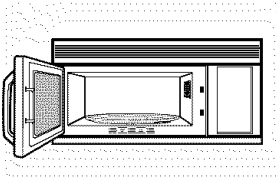

### **Walls, Floor, Inside Window, Metal and Plastic Parts on the Door**

Some spatters can be removed with a paper towel, others may require a damp cloth. Remove greasy spatters with a sudsy cloth, then rinse with a damp cloth. Do not use abrasive cleaners or sharp utensils on oven walls. **Never use a commercial oven cleaner on any part of your microwave.**

### **Temperature Probe (if included)**

Clean immediately after using. To clean, wipe with a sudsy cloth, then rub lightly with a plastic scouring ball if necessary. Rinse and dry. The probe can also be washed in the dishwasher.

### **Removable Turntable and Turntable Support**

To prevent breakage, do not place the turntable into water just after cooking. Wash it carefully in warm, sudsy water or in the dishwasher. The turntable and support can be broken if dropped. Remember, do not operate the oven without the turntable and support in place.

### **Shelf (if included)**

Clean with mild soap and water or in the dishwasher.

**Do not clean in a self-cleaning oven.**





### Care and Cleaning

#### How to Clean the Outside

*We recommend against using cleaners with ammonia or alcohol, as they can damage the appearance of the microwave oven. If you choose to use a common household cleaner, first apply the cleaner directly to a clean cloth, then wipe the soiled area.*

##### **Case**

Clean the outside of the microwave with a sudsy cloth. Rinse and then dry. Wipe the window clean with a damp cloth.

##### **Control Panel**

Wipe with a damp cloth. Dry thoroughly. Do not use cleaning sprays, large amounts of soap and water, abrasives or sharp objects on the panel—they can damage it. Some paper towels can also scratch the control panel.

##### **Door Panel**

Before cleaning the front door panel, make sure you know what type of panel you have. Refer to the eighth digit of the model number. "S" is stainless steel, "G" is Graphite, "L" is CleanSteel and "B", "W" or "C" are plastic colors.

##### **Stainless Steel**

The stainless steel panel can be cleaned with Stainless Steel Magic or a similar product using a clean, soft cloth. Apply stainless cleaner carefully to avoid the surrounding plastic parts. Do not use appliance wax, polish,

bleach or products containing chlorine on Stainless Steel finishes.

##### **CleanSteel or Graphite**

Use a clean, soft, light and lightly dampened cloth, then dry thoroughly. Do not use appliance wax, polish, bleach or products containing any chemical agent on the CleanSteel or Graphite surfaces.

##### **Plastic Color Panels**

Use a clean, soft, lightly dampened cloth, then dry thoroughly.

##### **Door Seal**

It's important to keep the area clean where the door seals against the microwave. Use only mild, non-abrasive detergents applied with a clean sponge or soft cloth. Rinse well.

##### **Bottom**

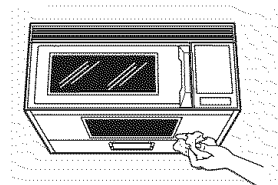

Clean off the grease and dust on the bottom often. Use a solution of warm water and detergent.



## Cooktop Light/ Night Light

Replace the burned-out bulb with a 120 volt, 40-watt incandescent bulb (WB36X10003), available from your GE supplier.

- 1 To replace the bulb(s), first disconnect the power at the main fuse or circuit breaker panel or pull the plug.
- 2 Remove the screw from light cover and lower the cover.
- 3 Be sure the bulb(s) to be replaced are cool before removing. After breaking the adhesive seal, remove the bulb by gently turning.
- 4 Replace the screw. Connect electrical power to the oven.

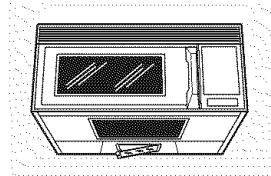
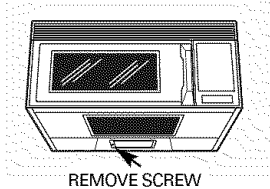

## Oven Light

Replace the burned-out bulb with a 120 volt, 40-watt incandescent bulb (WB36X10003), available from your GE supplier.

- 1 To replace the oven light, first disconnect the power at the main fuse or circuit breaker panel or pull the plug.
- 2 Remove the top grille by taking out the 2 screws that hold it in place.
- 3 Next, remove the screw located above the door near the center of the oven that secures the light housing.

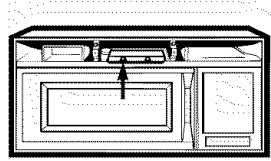
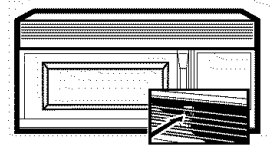

- 4 Replace the screw. Connect electrical power to the oven.



## Helpful Information

### The Exhaust Feature

#### The Vent Fan

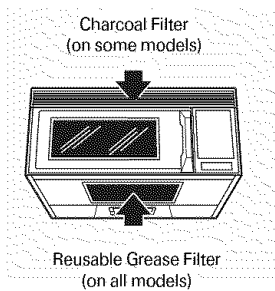

The vent fan has a metal reusable grease filter.

Models that recirculate air back into the room also use a charcoal filter.

#### Reusable Grease Filters

The reusable grease filter traps grease released by foods on the cooktop. It also prevents flames from foods on the cooktop from damaging the inside of the microwave.

For this reason, the filter must ALWAYS be in place when the hood is used. The grease filter should be cleaned once a month, or as needed.

#### Removing and Cleaning the Filter

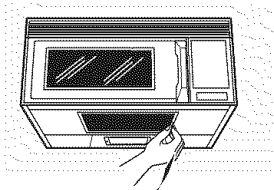

**To remove**, slide it to the side using the tab. Pull it down and out.

**To clean the grease filter**, soak it and then swish it around in hot water and detergent. Don't use ammonia or ammonia products because it will darken the metal. Light brushing can be used to remove embedded dirt.

Rinse, shake and let it dry before replacing.

**To replace**, slide the filter in the frame slot on the left side of the opening. Pull up and to the right to lock into place.



## Charcoal Filter (on some models)

**The charcoal filter cannot be cleaned. It must be replaced. Order Part No. WB2X9883 from your GE supplier.**

If the model is not vented to the outside, the air will be recirculated through a disposable charcoal filter that helps remove smoke and odors.

The charcoal filter should be replaced when it is noticeably dirty or discolored (usually after 6–12 months, depending on hood usage). See “Optional Kits,” page 9 for more information.

## To Remove Charcoal Filter

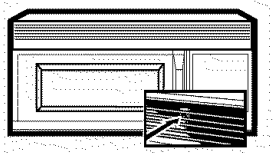

Remove 2 grille screws to remove the grille.

To remove the charcoal filter, disconnect power at the main fuse or circuit breaker panel or pull the plug.

Remove the top grille by removing the 2 screws that hold it in place. Slide the filter towards the front of the oven and remove it.

## To Install Charcoal Filter

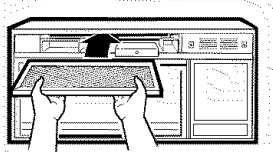

To install a new filter, remove plastic and other outer wrapping from the new filter.

Insert the filter into the top opening of the oven as shown. It will rest at an angle on 2 side support tabs and in front of the right rear tab. Replace the grille and 2 screws.



## If Something Goes Wrong

### Before You Call For Service

<b>Problem</b>	<b>Possible Cause</b>	<b>What to Do</b>
<b>Oven will not start</b>	A fuse in your home may be blown or the circuit breaker tripped. Power surge. Plug not fully inserted into wall outlet. Door not securely closed.	<ul style="list-style-type: none"><li>• Replace fuse or reset circuit breaker.</li><li>• Unplug the microwave oven, then plug it back in.</li><li>• Make sure the 3-prong plug on the oven is fully inserted into wall outlet.</li><li>• Open the door and close securely.</li></ul>
<b>Floor of the oven is warm, even when the oven has not been used</b>	The cooktop light is located below the oven floor. When the light is on, the heat it produces may make the oven floor get warm.	<ul style="list-style-type: none"><li>• This is normal.</li></ul>
<b>"LOC" appears on display</b>	The control has been locked.	<ul style="list-style-type: none"><li>• Press and hold CLEAR/OFF for about 3 seconds to unlock the control.</li></ul>
<b>Vent fan will not turn off</b>	The vent fan automatically turns on to cool internal parts while the microwave is on.	<ul style="list-style-type: none"><li>• The vent fan cannot be turned off while the microwave is operating. This is normal. Wait for the microwave to turn off and the fan will either go off automatically or you will need to turn it off by pressing the Vent Fan pad after the microwave is off.</li></ul>
<b>"BAD PROBE" appears on display</b>	The probe has not been completely inserted into the oven wall outlet. The probe is defective.	<ul style="list-style-type: none"><li>• Insert the probe properly into the oven wall outlet.</li><li>• Replace the probe.</li></ul>
<b>"PLEASE INSERT PROBE" appears on display</b>	Probe has been forgotten or not inserted properly.	<ul style="list-style-type: none"><li>• Insert the probe properly into the oven wall outlet.</li></ul>
<b>"SENSOR ERROR" appears on display</b>	When using a Sensor feature, the door was opened before steam could be detected. Steam was not detected in maximum amount of time.	<ul style="list-style-type: none"><li>• Do not open door until steam is sensed and time is shown counting down on display.</li><li>• Use Time Cook to heat for more time.</li></ul>

**Things That  
Are Normal**

- Moisture on the oven door and walls while cooking. Wipe the moisture off with a paper towel or soft cloth.
- Moisture between the oven door panels when cooking certain foods. Moisture should dissipate shortly after cooking is finished.
- Steam or vapor escaping from around the door.
- Light reflection around door or outer case.
- Dimming oven light and change in the blower sound at power levels other than high.
- Dull thumping sound while oven is operating.
- The vent fan operating while the microwave is operating. The vent fan will not go off nor can it be turned off until the microwave is off.
- TV-radio interference might be noticed while using the microwave. Similar to the interference caused by other small appliances, it does not indicate a problem with the microwave. Plug the microwave into a different electrical circuit, move the radio or TV as far away from the microwave as possible or check the position and signal of the TV/radio antenna.

## GE Service Numbers



*We'll Be There!*

### GE Appliances Website

**ge.com**

Have a question or need assistance with your appliance? Try the GE Appliances Website 24 hours a day, any day of the year!

For greater convenience and faster service, you can now download Owner's Manuals, order parts, catalogs, or even schedule service on-line. You can also "Ask Our Team of Experts™" your questions, and so much more...

### Schedule Service

**ge.com**

**800.GE.CARES**  
**(800.432.2737)**

Expert GE repair service is only one step away from your door. Get on-line and schedule your service at your convenience 24 hours any day of the year!

Or call 800.GE.CARES (800.432.2737) during normal business hours.

### Real Life Design Studio

**ge.com**

**800.TDD.GEAC**  
**(800.833.4322)**

GE supports the Universal Design concept—products, services and environments that can be used by people of all ages, sizes and capabilities. We recognize the need to design for a wide range of physical and mental abilities and impairments.

For details of GE's Universal Design applications, including kitchen design ideas for people with disabilities, check out our Website today. For the hearing impaired, please call 800.TDD.GEAC (800.833.4322).

### Extended Warranties

**ge.com**

**800.626.2224**

Purchase a GE extended warranty and learn about special discounts that are available while your warranty is still in effect.

You can purchase it on-line anytime, or call 800.626.2224 during normal business hours. GE Consumer Home Services will still be there after your warranty expires.



---

## **Parts and Accessories**

***ge.com***

***800.626.2002***

Individuals qualified to service their own appliances can have parts or accessories sent directly to their home. (VISA, MasterCard and Discover cards are accepted.)

Order on-line today, 24 hours every day or by phone at ***800.626.2002*** during normal business hours.

**Instructions contained in this manual cover procedures to be performed by any user. Other servicing generally should be referred to qualified service personnel. Caution must be exercised, since improper servicing may cause unsafe operation.**

---

## **Register Your Appliance**

***ge.com***

**Register your new appliance on-line—  
at your convenience!**

Timely product registration will allow for enhanced communication and prompt service under the terms of your warranty, should the need arise. You may also mail in the pre-printed registration card included in the packing material.



## MICROWAVE OVEN WARRANTY

Staple sales slip or cancelled check here. Proof of original purchase date is needed to obtain service under warranty.

### What Is Covered

#### LIMITED ONE-YEAR WARRANTY

For one year from date of original purchase, GE will replace *any part* in the microwave oven that fails due to a defect in materials or workmanship. During this *limited one-year warranty*, GE will provide, *free of charge*, all labor and related service costs to replace the defective part.

\*\*\*\*\*

All warranty service will be provided by our Factory Service Centers or by our authorized Customer Care® servicers during normal working hours.

Should your appliance need service, during warranty period or beyond, call 800.GE.CARES (800.432.2737).

Please have serial and model numbers available when calling for service.

### What Is Not Covered

- Service trips to your home to teach you how to use the product.
- Improper installation, delivery or maintenance. If you have an installation problem, contact your dealer or installer. You are responsible for providing adequate electrical, exhausting and other connecting facilities.
- Product not accessible to provide required service.
- Replacement of house fuses or resetting of circuit breakers.
- Replacement of the cooktop light bulbs.
- Failure of the product or damage to the product if it is abused, misused (for example, cavity arcing from wire rack or metal/foil), or used for other than the intended purpose or used commercially.
- Damage to product caused by accident, fire, floods or acts of God.
- Incidental or consequential damage caused by possible defects with this appliance.
- Damage caused after delivery.

**EXCLUSION OF IMPLIED WARRANTIES—Your sole and exclusive remedy is product repair as provided in this Limited Warranty. Any implied warranties, including the implied warranties of merchantability or fitness for a particular purpose, are limited to one year or the shortest period allowed by law.**

This warranty is extended to the original purchaser and any succeeding owner for products purchased for home use within the USA. If the product is located in an area where service by a GE Authorized Servicer is not available, you may be responsible for a trip charge or you may be required to bring the product to an Authorized GE Service Location for service. In Alaska, the warranty excludes the service calls to your home.

Some states do not allow the exclusion or limitation of incidental or consequential damages, so the above limitation or exclusion may not apply to you. This warranty gives you specific legal rights, and you may also have other rights which vary from state to state. To know what your legal rights are in your state, consult your local or state consumer affairs office or your state's Attorney General.

Warrantor: General Electric Company, Louisville, KY 40225