

This Owner's Manual is provided and hosted by [Appliance Factory Parts](http://www.ApplianceFactoryParts.com).

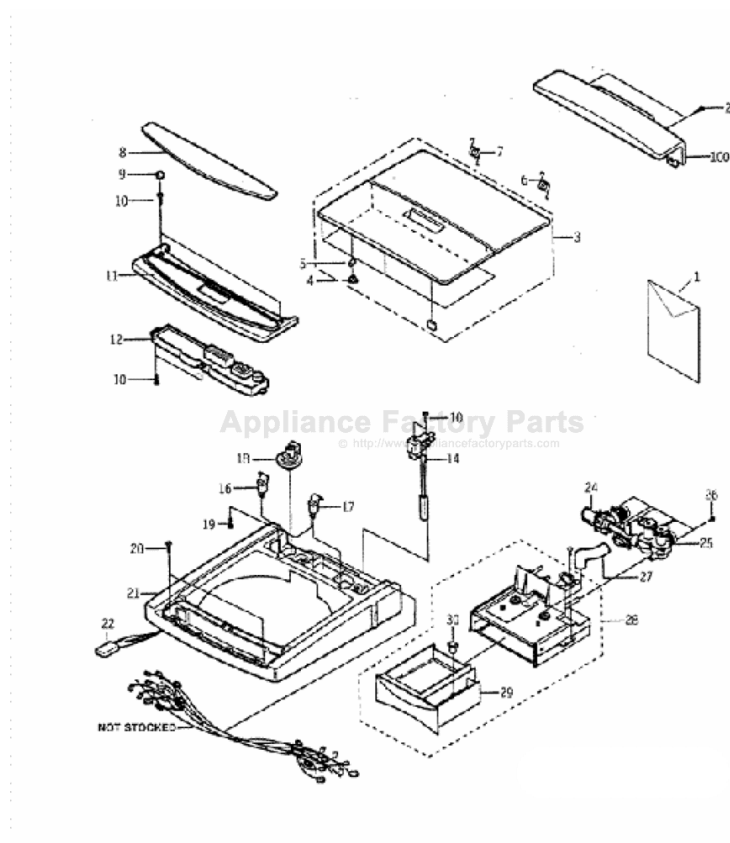

GE WSL S1100A0AA Owner's Manual

[Shop genuine replacement parts for GE
WSL S1100A0AA](#)



[Find Your GE Washer Parts - Select From 4591 Models](#)

----- Manual continues below -----



Washers

Safety Information 2, 3

Operating Instructions

Control and Indicator Settings . . . 5, 6
Loading and Using the Washer . . 7, 8
Special Washer Features 4

Installation Instructions

Alcove or Closet Installation 12
Electrical Requirements 10
Grounding Instructions 10
Installation Requirements 9
Leveling the Washer 10
Washer Connections for
Portable Model WSLP1100 . . . 13–16
Washer Connections for
Stationary Models WSL1100
and WSLM1100 11, 12

Troubleshooting Tips

Before You Call For Service . . 17–20
Status Indicators 17

Consumer Support

Consumer Support Back Cover
Product Registration 21, 22
Warranty 23

***Owner's Manual &
Installation Instructions***

WSLS1100
WSLP1100
WSLM1100

***Write the model and serial
numbers here:***

You can find them on a label
on the back of the washer.



IMPORTANT SAFETY INFORMATION. READ ALL INSTRUCTIONS BEFORE USING.

⚠ WARNING! For your safety, the information in this manual must be followed to minimize the risk of fire or explosion, electric shock, or to prevent property damage, personal injury, or loss of life.



WATER HEATER SAFETY

Under certain conditions hydrogen gas may be produced in a water heater that has not been used for two weeks or more. Hydrogen gas can be explosive under these circumstances.

If the hot water has not been used for two weeks or more, prevent the possibility of damage or injury by turning on all hot water faucets and allowing them to run for several minutes. Do this before using any electrical appliance which is connected to the hot water system. This simple procedure will allow any built-up hydrogen gas to escape. Since the gas is flammable, do not smoke or use an open flame or appliance during this process.



PROPER INSTALLATION

This washer must be properly installed and located in accordance with the Installation Instructions before it is used.

- Install or store where it will not be exposed to temperatures below freezing or exposed to the weather.
- Properly ground washer to conform with all governing codes and ordinances. Follow details in Installation Instructions.



YOUR LAUNDRY AREA

- Keep the area underneath and around your appliances free of combustible materials such as lint, paper, rags, chemicals, etc.
- Close supervision is necessary if this appliance is used by or near children. Do not allow children to play on, with, or inside this or any other appliance.



WHEN USING THE WASHER

Use this appliance only for its intended purpose as described in this Owner's Manual.

- Never reach into washer while it is moving. Wait until the machine has completely stopped before opening the lid.
- Do not use sharp objects around the control panel. They may damage it.
- Do not mix chlorine bleach with ammonia or acids such as vinegar and/or rust remover. Mixing different chemicals can produce a toxic gas which may cause death.
- Do not wash or dry articles that have been cleaned in, washed in, soaked in, or spotted with combustible or explosive substances (such as wax, oil, paint, gasoline, degreasers, dry-cleaning solvents, kerosene, etc.) which may ignite or explode. Do not add these substances to the wash water. Do not use or place these substances around your washer or dryer during operation.
- The laundry process can reduce the flame retardancy of fabrics. To avoid such a result, carefully follow the garment manufacturer's wash and care instructions.
- To minimize the possibility of electric shock, unplug this appliance from the power supply or disconnect the washer at the household distribution panel by removing the fuse or switching off the circuit breaker before attempting any maintenance or cleaning. **NOTE:** Turning the washer off does **NOT** disconnect the appliance from the power supply.
- Never attempt to operate this appliance if it is damaged, malfunctioning, partially disassembled, or has missing or broken parts, including a damaged cord or plug.



WHEN NOT IN USE

- Turn off water faucets to relieve pressure on hoses and valves and to minimize leakage if a break or rupture should occur. Check the condition of the fill hoses; they may need replacement after 5 years.
- Before discarding a washer, or removing it from service, remove the washer lid to prevent children from hiding inside.
- Do not attempt to repair or replace any part of this appliance unless specifically recommended in this Owner's Manual, or in published user-repair instructions that you understand and have the skills to carry out.
- Do not tamper with controls.



READ AND FOLLOW THIS SAFETY INFORMATION CAREFULLY.

SAVE THESE INSTRUCTIONS

Special washer features.

Before starting the washer:

- Load the laundry in the washer.
- Add the detergent and fabric softener to the dispenser drawer.
- Add bleach (if needed) to the bleach dispenser.

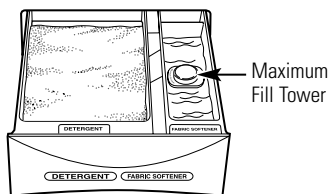

Detergent and Fabric Softener Dispenser Drawer

The detergent and fabric softener dispensers will automatically release their contents at the proper time during the cycle.

To Use the Detergent Dispenser:

Add measured detergent to the dispenser. Make sure detergent is spread evenly and is level.

To Use the Fabric Softener Dispenser:

Use only liquid fabric softener. Pour into dispenser, using amount recommended on package.

- Do not fill any higher than the top of the maximum fill tower.
- Never pour fabric softener directly on clothes. It may stain them.

Cleaning the Detergent and Fabric Softener Dispenser Drawer

- 1 Remove the drawer by opening it fully then tilting the front of the door down. Pull out.
- 2 Rinse the drawer with water. If necessary use a soft cloth to wipe off any debris.
- 3 Line up the drawer with the opening and push the dispenser drawer straight in.

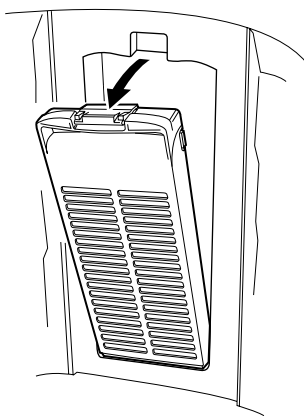

Lint Filters

Clean the lint filters inside the walls of the wash basket once a week for best filtering results.

To remove:

Press the tab at the top of the filter and pull out.

To clean:

Open the filter. Clean the filter with a toothbrush.

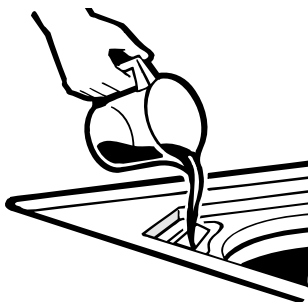
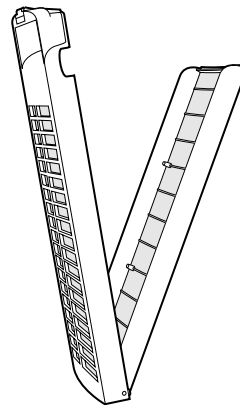

Liquid Bleach Dispenser

The dispenser dilutes liquid chlorine bleach before it reaches into your wash load.

- 1 Check clothing care labels for special instructions.
- 2 Measure liquid bleach carefully, following instructions on the bottle.
 - Never pour undiluted liquid chlorine bleach directly onto clothes or into the wash basket.
 - Do not pour powdered bleach into bleach dispenser.
- 3 Before starting the washer, pour measured amount of bleach directly into bleach dispenser. Avoid splashing or over-filling dispenser. If you prefer to use powdered bleach, add it into the wash basket with your detergent.
 - Do not mix chlorine bleach with ammonia or acids such as vinegar and/or rust remover. Mixing can produce a toxic gas which may cause death.

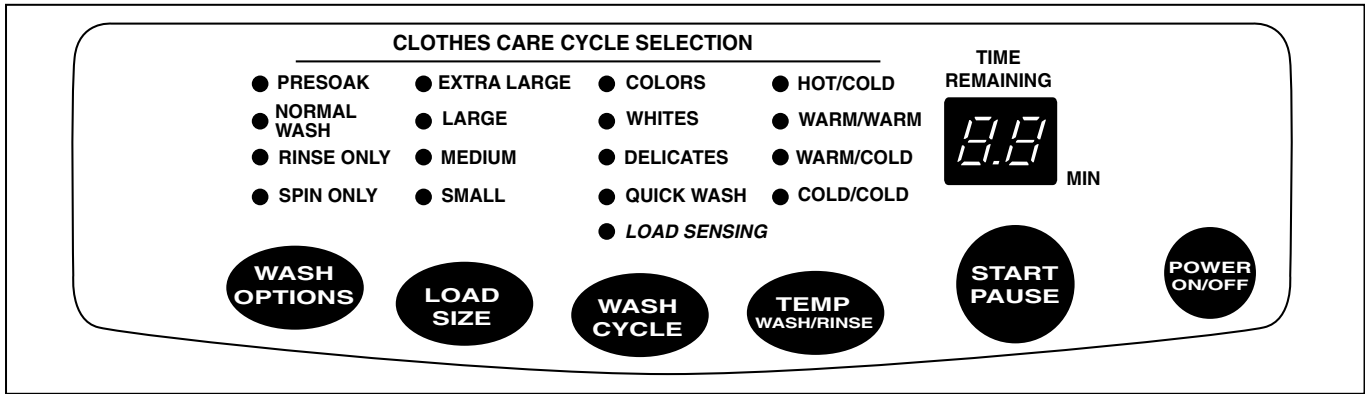

Before starting the washer:

- Load the laundry in the washer.
- Add the detergent and fabric softener to the dispenser drawer.
- Add bleach (if needed) to the bleach dispenser.



To Use Automatic One-Touch Washing

The **LOAD SENSING** feature automatically senses the size of your load, fills with the appropriate amount of water, and calculates the amount of wash time required to complete the cycle.

NOTE: When using the **LOAD SENSING** feature, it is normal for the agitator to rotate before water fills in the tub.

To choose the automatic **LOAD SENSING** feature, press **POWER ON/OFF**.

The following indicators will light up automatically: **NORMAL WASH, LOAD SENSING** and **COLD/COLD**.

Then simply press **START/PAUSE**.

To Choose Your Own Cycle Selections

1 POWER ON/OFF

Press the **POWER ON/OFF** button to turn on the control panel.

2 WASH OPTIONS

Choose the wash options you would like to include in the cycle. Press the **WASH OPTIONS** button until all the options you want to include are lit. More than one option can be selected.

PRESOAK For heavily soiled clothes that need to be soaked before washing. This option can be used as part of the **WASH CYCLE** you select.

NORMAL WASH This option is automatically selected when you press **POWER ON/OFF**.

RINSE ONLY This option gives one rinse cycle only. For example: Use this cycle when you need to remove excess detergent from your clothing.

SPIN ONLY This option gives one spin cycle only. For example: Use this cycle when you need to remove excess water from your clothing.

About the control and indicator settings.

3 LOAD SIZE

The water level should just cover the clothes. Adjust the load size accordingly. Loosely load clothes no higher than the top row of holes in the washer basket.

4 WASH CYCLE

These wash cycles control the length of the washing process. The chart below will help match the **WASH CYCLE** setting to your specific laundry needs. When a cycle is selected, the automatic temperature that the machine defaults to, can be changed to whatever temperature you desire.

	<i>Default Wash/Rinse Temperatures</i>
COLORS For easy care and wrinkle-resistant items.	WARM / COLD
WHITES For heavy to lightly soiled cotton, household linens, towels, work and play clothes.	HOT / COLD
DELICATES For lingerie and delicate fabrics with light to normal soils.	COLD / COLD
QUICK WASH For one or two lightly soiled items that are needed quickly.	WARM / COLD

5 TEMP WASH/RINSE

Select the water temperature for the wash and rinse cycles. Always follow fabric manufacturer's care label or instructions when laundering.

NOTE FOR PORTABLE MODELS: When using a one-faucet connection, adjust the water flow mix and water temperature at the faucet.

6 START/PAUSE

Press the **START/PAUSE** button to start the wash cycle.

7 TIME REMAINING

Displays the time remaining in the wash cycle. It will also display Status Indicators. See *Troubleshooting Tips*.

NOTE: When the cycle is complete the control panel will turn off automatically.

Loading and using the washer.

Always follow fabric manufacturer's care label when laundering.

www.GEAppliances.com

Safety Instructions

Operating Instructions

Installation Instructions

Troubleshooting Tips

Consumer Support



Sorting Wash Loads

Colors	Soil	Fabric	Lint
Whites	Heavy	Delicates	Lint Producers
Lights	Normal	Easy Care	Lint Collectors
Darks	Light	Sturdy Cottons	

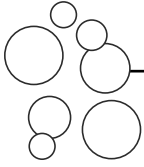

Proper Use of Detergent

Add clothes and detergent, then start the washer. Using too little or too much detergent is a common cause of laundry problems.

You can use less detergent if you have soft water, a smaller load, or a lightly soiled load.



Loading the Washer

Load dry items loosely, no higher than the top row of holes in the washer tub. When loading wet items make sure you set the load/water level high enough to allow the items to move freely. Water level should just cover the clothes. To add items after washer has started, open the lid and add the additional items. Close the lid. Washer will start automatically.

- Do not wrap large items like sheets around the agitator.
- Do not wash fabrics containing flammable materials (waxes, cleaning fluids, etc.).
- When the lid is up, a signal will sound and "Lo" will appear in the display. The washer will not agitate with the lid up.



Care and Cleaning of the Washer

Wash Basket: Leave the lid open after washing to allow moisture to evaporate. If you want to clean the basket use a clean soft cloth dampened with liquid detergent, then rinse. (Do not use harsh or gritty cleaners.)

Fill Hoses: Hoses connecting washer to faucet should be replaced every 5 years.

Exterior: Immediately wipe off any spills. Wipe with damp cloth. Try not to hit surface with sharp objects.

Moving and Storage: Ask the service technician to remove water from drain pump and hoses. Do not store the washer where it will be exposed to the weather.

Long Vacations: Be sure water supply is shut off at faucets. Drain all water from hoses if weather will be below freezing.

Loading and using the washer.



Fabric Care Labels

Below are fabric care label “symbols” that affect the clothing you will be laundering.

WASH LABELS

Machine wash cycle						
Water temperature						

DRY LABELS

Tumble dry						
Heat setting						
Special instructions						

BLEACH LABELS

Bleach symbols			
-----------------------	--	--	--

Installation Instructions

Washer

WSLS1100 WSLP1100 WSLM1100

If you have questions, call 800-GE CARES or visit our Website at: www.GEAppliances.com

BEFORE YOU BEGIN

Read these instructions completely and carefully.

- **IMPORTANT** — Save these instructions for local inspector's use.
- **IMPORTANT** — Observe all governing codes and ordinances.
- **Note to Installer** — Be sure to leave these instructions with the Consumer.
- **Note to Consumer** — Keep these instructions for future reference.
- **Skill level** — Installation of this appliance requires basic mechanical skills.
- **Completion time** — 1 hour
- Proper installation is the responsibility of the installer.
- Product failure due to improper installation is not covered under the Warranty.
- **Note** — This appliance must be properly grounded, and electrical service to the washer must conform with local codes and ordinances and the latest edition of the National Electrical Code, ANSI/NFPA 70.

WASHER LOCATION

Washer must be installed on firm flooring to minimize vibration during spin cycles. Concrete flooring is best, but wood base is sufficient providing floor support meets FHA standards. Washer should not be installed on rugs or exposed to the weather.

Install or store where it will not be exposed to temperatures below freezing or exposed to the weather.

ELECTRICAL

This appliance must be supplied with the voltage and frequency indicated on the rating plate (located on the back of the washer), and connected to an individual, properly grounded branch circuit, protected by a 15 or 20 amp circuit breaker or time-delay fuse.

If the washer is plugged into the dryer's 115 volt outlet, then the dryer needs to be on a dedicated circuit.

PLUMBING

- **WATER PRESSURE**—Must be 10 p.s.i. minimum to 150 p.s.i. maximum dynamic pressure measured at faucet.
- **WATER TEMPERATURE**—Household water heater should be set to deliver water at 120° to 150°F (50° to 66°C) IN THE WASHER when HOT wash is selected.
- **SHUT-OFF VALVES**—Both hot and cold shut-off valves (faucets) should be supplied.
- **DRAIN**—Water may be drained into a standpipe or set tub. The discharge height **MUST NOT BE LESS THAN 30"** nor more than 8' above the base of the washer. The standpipe must be 1½" minimum inside diameter and must be open to the atmosphere.

RACK INSTALLATION

- Ensure washer is centered between the rack sides.

PARTS SUPPLIED

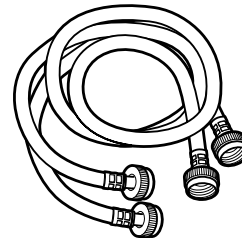

Water Hoses (2)



Cable Tie

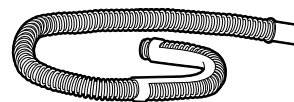

Drain Hose

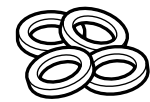

Rubber Washers (4)

TOOLS REQUIRED



Pliers

Installation Instructions

▲ CAUTION: Before plugging in washer, read the following electrical requirements.

ELECTRICAL REQUIREMENTS

▲ CAUTION: For personal safety, do not use an extension cord or adapter plug with this appliance.

Do not, under any circumstances, cut or remove the third grounding prong from the power cord. Follow National Electrical Codes or prevailing local codes and ordinances.

This appliance must be supplied with the voltage and frequency indicated on the rating plate (located on the back of the washer), and connected to an individual, properly grounded branch circuit, protected by a 15 or 20 amp circuit breaker or time-delay fuse.

If the electric supply provided does not meet the above requirements, call a licensed electrician.

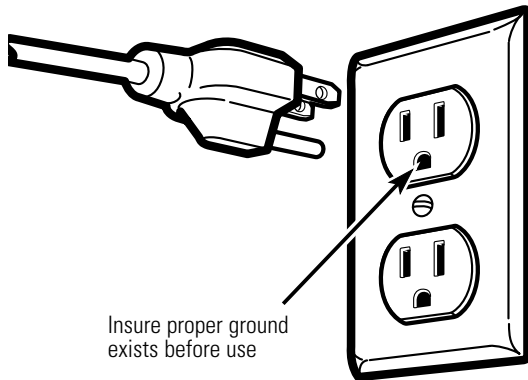

GROUNDING INSTRUCTIONS

This appliance must be grounded. In the event of a malfunction or breakdown, grounding will reduce the risk of electric shock by providing a path of least resistance for electrical current.

This appliance is equipped with a cord having an equipment grounding conductor and a grounding plug.

The plug must be plugged into an appropriate outlet that is properly installed and grounded in accordance with all local codes and ordinances.

▲ DANGER: Improper connection of the equipment-grounding conductor can result in a risk of electrical shock. Check with a qualified electrician if you are in doubt as to whether the appliance is properly grounded.

Do not modify plug with this appliance; if it will not fit the outlet installed, have a proper outlet installed by a qualified electrician.

LEVELING THE WASHER— STATIONARY MODELS

Before connecting the hoses, the washer must be level. Leveling locks are located at the bottom front of the left and right sides of the washer.

1 MAKE SURE THE WASHER IS IN ITS FINAL LOCATION

2 PULL OUT THE LEVELING LOCKS

This releases the spring loaded leveling feet. The washer will automatically level itself.

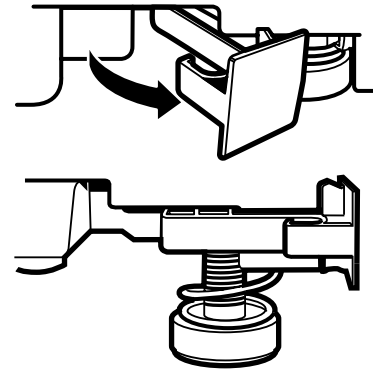

3 PUSH THE LEVELING LOCKS BACK IN



Do not kick or step on the leveling locks.

Installation Instructions

WASHER CONNECTIONS FOR STATIONARY MODELS WSLS1100 AND WSLM1100

▲ WARNING: Make sure the washer is unplugged.

1 FLUSH WATER LINES

Run some water from the hot and cold faucets to flush the water lines and remove particles that might clog up the water valve screens.

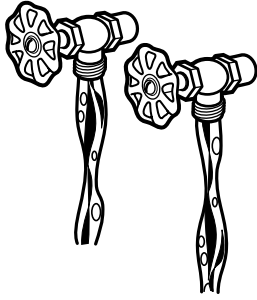

2 CONNECT TO WATER LINES

Connect the inlet hose ends to the **HOT** and **COLD** water faucets tightly by hand, then tighten another $\frac{2}{3}$ turn with pliers. Turn the water on and check for leaks.

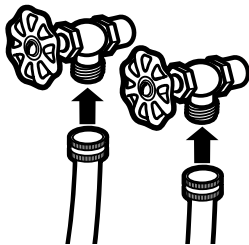

3 CAREFULLY MOVE THE WASHER TO ITS FINAL LOCATION

4 CONNECT DRAIN HOSE

Form a U shape on the end of the drain hose with the hose pointed toward the drain. Place the hose in a laundry tub or stand pipe and secure it with a cable tie (not included).

NOTE: If the drain hose is placed in a stand pipe without forming a U shape, a siphoning action could occur. There must be an air gap around the drain hose. A snug hose fit can also cause a siphoning action.

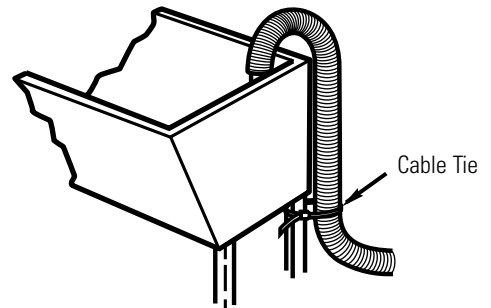

Laundry Tub

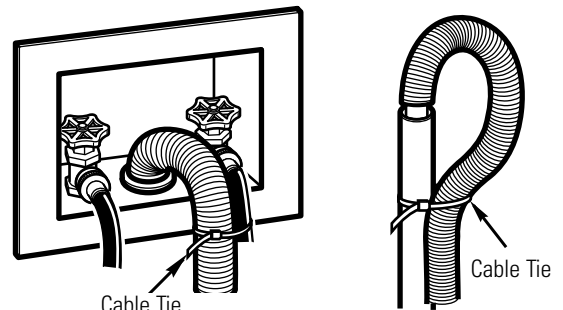

Stand Pipe

5 PLUG THE POWER CORD INTO A GROUNDING OUTLET

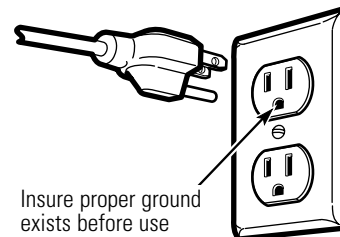

Insure proper ground exists before use

Installation Instructions

WASHER CONNECTIONS FOR STATIONARY MODELS WSLS1100 AND WSLM1100 (CONT.)

6 INSTALLATION CHECKLIST

Before starting the washer, check to make sure:

- Main power is turned on.
- The washer is plugged in.
- The water faucets are turned on.
- The unit is level.
- The drain hose is properly tied up.
- There are no leaks at the faucet, drain line or washer.

7 RUN THE WASHER THROUGH A COMPLETE CYCLE

Check for water leaks and proper operation.

8 REMOVE THE PROTECTIVE FILM COVERING THE CONTROL PANEL

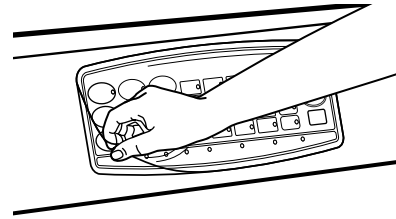

9 READ THE REST OF THIS OWNER'S MANUAL

It contains valuable and helpful information that will save you time and money.

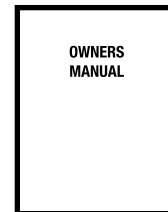

NOTE: If your washer does not operate, please review the *Before You Call For Service* section.

ALCOVE OR CLOSET INSTALLATION

If your washer is approved for installation in an alcove or closet, there will be a label on the back of the machine describing requirements.

- Minimum clearances between washer and adjacent walls or other surfaces are: 0" either side, 2" front, 3" rear.
- Minimum vertical space from floor to overhead shelves, cabinets, ceilings, etc. is 96".
- Closet doors must be louvered or otherwise ventilated and have at least 60 square inches open area for washer only, or if the closet contains both a washer and dryer, doors must contain at least 120 square inches of open area equally distributed.

NOTE: The clearances stated on this label are minimums. Consideration must be given to providing adequate clearances for installation and servicing.

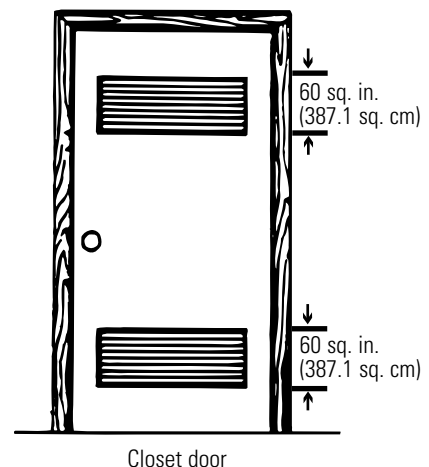

Installation Instructions

WASHER CONNECTIONS FOR PORTABLE MODEL WSLP1100—ONE-FAUCET CONNECTIONS

Use the hose connector provided with the washer for a one-faucet connection.

TO CONNECT THE WASHER:

1 REMOVE THE UNI-COUPLE® HOSE FROM INSIDE THE WASHER BASKET

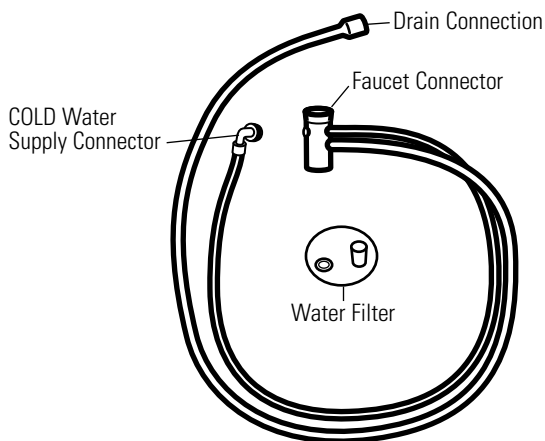

Uni-Coupler Hose

2 CONNECT TO WATER LINE

Attach the hose connector to the faucet adapter by pulling down on the locking collar while lifting up on the connector until it snaps into place. Make sure the water filter provided is in place.

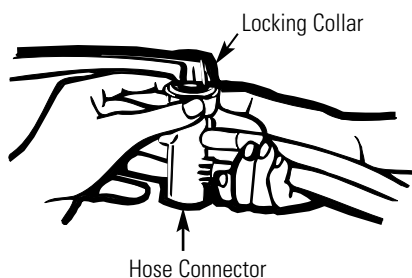

3 CONNECT TO VALVE INLET

Attach the **COLD** water supply connector to the **COLD** water valve inlet (color **BLUE**). Make sure the washer is inside the connector before tightening.

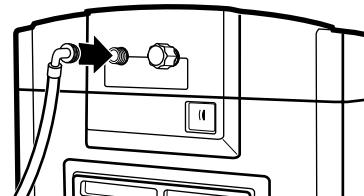

4 TIGHTEN CONNECTOR

Tighten the connector, ensuring the threads are aligned properly for tightest fit. Inspect for kinks or binding of the hose.

NOTE: Do not remove the plastic cap from the **HOT** water inlet for uni-coupler connections as leakage may occur.

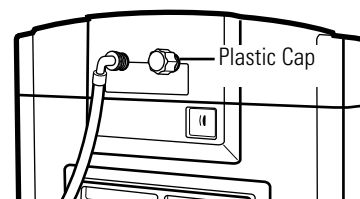

5 CONNECT DRAIN HOSE

Attach the drain hose to the rear of the washer. Install the clamp on the drain hose and tighten to prevent leakage of water.

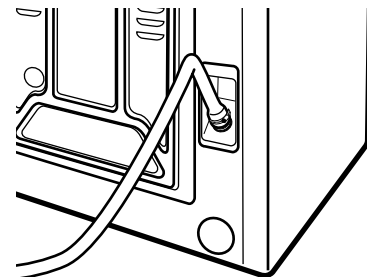

Installation Instructions

WASHER CONNECTIONS FOR PORTABLE MODEL WSLP1100—ONE-FAUCET CONNECTIONS (CONT.)

- 6 MAKE SURE THE TEMPERATURE SELECTOR IS SET AT COLD/COLD**

- 7 SLOWLY TURN ON THE WATER FAUCET ALL THE WAY TO THE DESIRED TEMPERATURE SETTING**

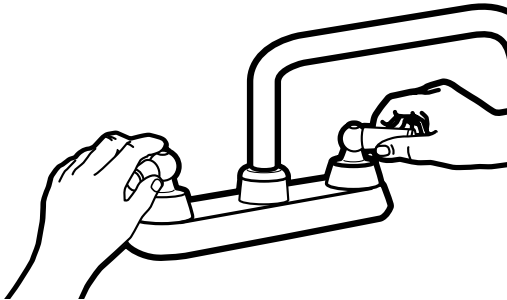

- 8 PLUG THE POWER CORD INTO A 3-PRONG GROUNDED OUTLET**

The electrical power cord is on the back of the washer.

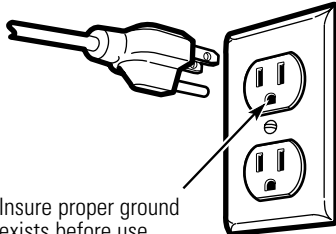

Insure proper ground exists before use

- 9 REMOVE THE PROTECTIVE FILM COVERING THE CONTROL PANEL**

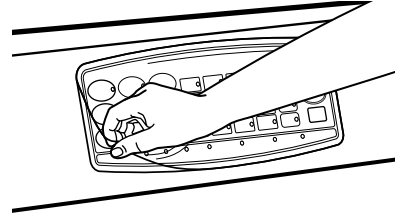

- 10 INSTALLATION CHECKLIST**

Before starting the washer, check to make sure:

- Main power is turned on.
- The washer is plugged in.
- The water faucets are turned on.
- The unit is level.
- There are no leaks at the faucet, drain line or washer.

Installation Instructions

TO DISCONNECT THE WASHER:

1 TURN WATER FAUCET OFF

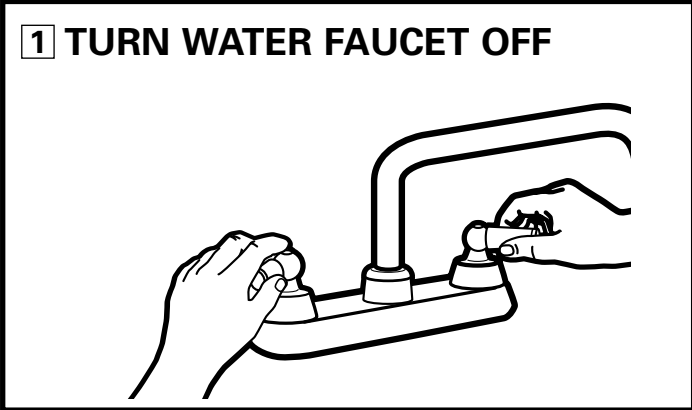

2 UNPLUG POWER CORD AND RETURN IT TO THE STORAGE AREA

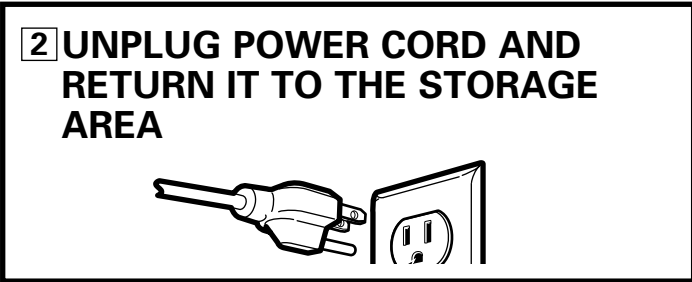

3 PRESS THE RED WATER FLOW BUTTON TO RELEASE THE WATER PRESSURE

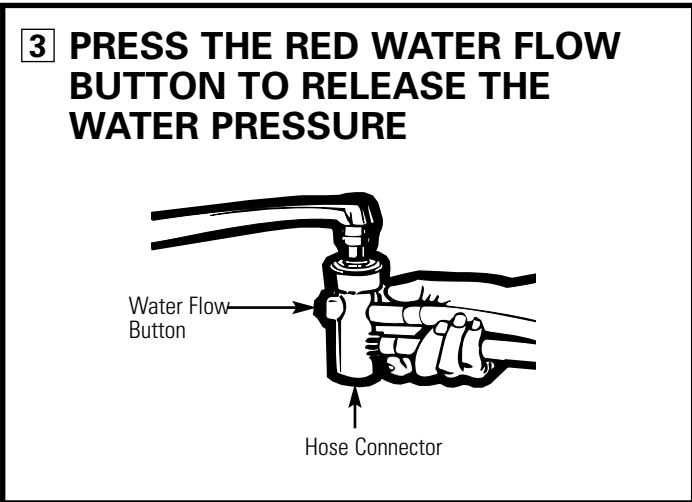

4 DISCONNECT FROM WATER LINE

Move the locking collar down and pull the hose connector down to disengage from the faucet adapter.

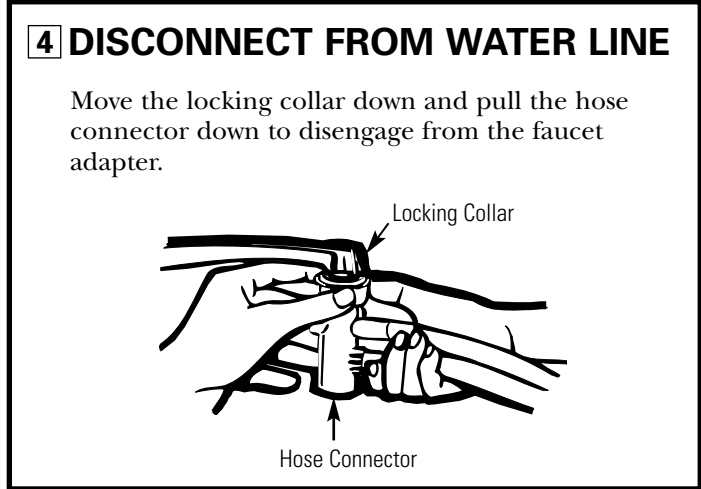

5 DRAIN WATER

Drain water from the hoses through the hose connector.

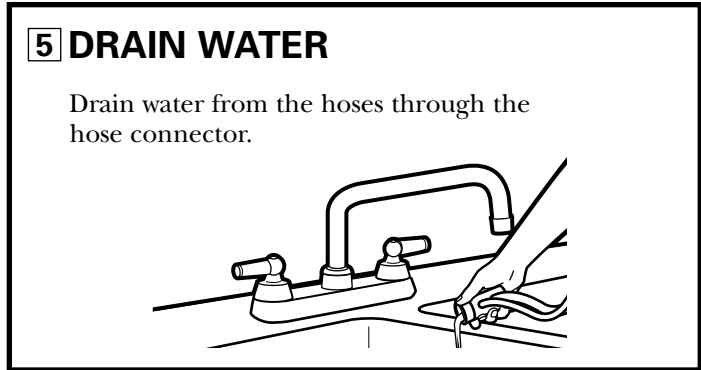

Installation Instructions

WASHER CONNECTIONS FOR PORTABLE MODEL WSLP1100—TWO-FAUCET CONNECTIONS

If you have two separate water connections, your washer can be connected to both the hot and cold water faucets. This kit can be purchased from your dealer or from Parts and Accessories. **In the United States**, call 800.626.2002. **In Canada**, consult the yellow pages for your local Camco number.

TO CONNECT THE WASHER:

1 CONNECT TO WATER LINE

Connect **HOT** and **COLD** water inlet hoses to the **HOT** and **COLD** faucets.

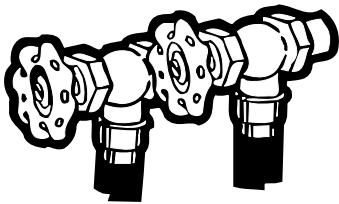

2 CONNECT DRAIN HOSE

Secure the drain hose to the sink or stand pipe.

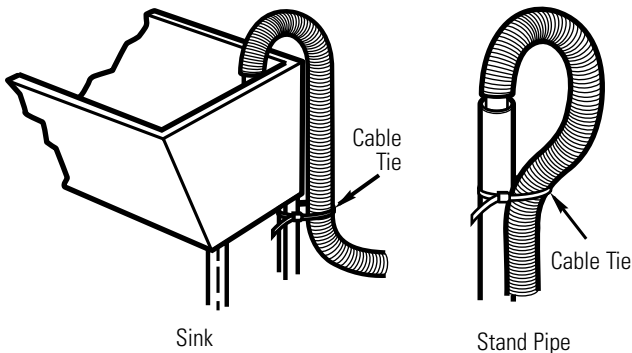

3 PLUG THE POWER CORD INTO A 3-PRONG GROUNDED OUTLET

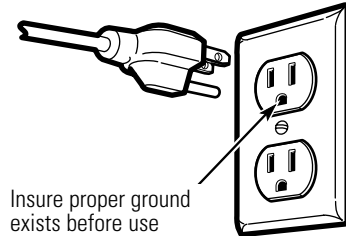

4 INSTALLATION CHECKLIST

Before starting the washer, check to make sure:

- Main power is turned on.
- The washer is plugged in.
- The water faucets are turned on.
- The unit is level.
- The drain hose is properly tied up.
- There are no leaks at the faucet, drain line or washer.

TO DISCONNECT THE WASHER:

1 TURN WATER FAUCETS OFF

2 UNPLUG POWER CORD AND RETURN IT TO THE STORAGE AREA

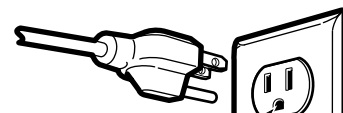

3 DISCONNECT THE DRAIN AND WATER SUPPLY HOSES

Hang them on the storage rack.



Troubleshooting Tips
Save time and money! Review the charts on the following pages first and you may not need to call for service.

Status Indicators

IE

- Press **POWER ON/OFF** to turn off the washer.
- Call for service.

FF

When the cycle has started but water has not filled the wash basket within 60 minutes, a signal will sound and this code will be displayed.

- Make sure the incoming water faucets are on.
- Make sure the fill hoses are not clogged or kinked.

Po

Power did not automatically turn off at the end of the cycle.

- Press **POWER ON/OFF** to turn off the washer.

dr

Water is not draining out of the washer.

- Make sure the drain hose is not kinked and is connected properly.

Ub

Wash load is unbalanced.

- Distribute laundry evenly in the basket.
- Make sure washer is level. See *Leveling the Washer*.

Lo

Washer lid is not closed.

- Close lid.

2h

Any time the total time required is more than 99 minutes, this status indicator will be displayed.

Before you call for service...



Troubleshooting Tips

WATER	POSSIBLE CAUSES	WHAT TO DO
Too many suds	Type of detergent	<ul style="list-style-type: none"> • Switch to a lower sudsing detergent brand and follow instructions on package.
	Very soft water	<ul style="list-style-type: none"> • Try less detergent.
	Too much detergent	<ul style="list-style-type: none"> • Measure your detergent carefully. Use less soap if you have soft water, a smaller load, or a lightly soiled load.
Water leaks	Fill hoses or drain hose is improperly connected	<ul style="list-style-type: none"> • Make sure hose connections are tight at faucets and the washing machine. Make sure the end of the drain hose is correctly inserted in and secured to the drain.
	Household drain may be clogged	<ul style="list-style-type: none"> • Check household plumbing. You may need to call a plumber.
	Constant water pressure to the fill hoses at the water source	<ul style="list-style-type: none"> • Tighten hoses at the faucets and turn the water off after each use. • Check condition of the fill hoses; they may need replacement after 5 years.
	Using too much detergent in washer	<ul style="list-style-type: none"> • Use less detergent. Use less soap if you have soft water, a smaller load, or a lightly soiled load.
Water temperature is incorrect	Water supply is turned off or improperly connected	<ul style="list-style-type: none"> • Turn both hot and cold faucets fully on and make sure hoses are connected to correct faucets.
	Water valve screens are stopped up	<ul style="list-style-type: none"> • Turn off the water source and remove the water connection hoses from the upper back of the washer. Remove screens and use a brush or toothpick to clean the screens in the machine. Reinstall screens, reconnect the hoses and turn the water back on.
	House water heater is not set properly	<ul style="list-style-type: none"> • Make sure house water heater is delivering water at 120°F.–140°F. (48°C.–60°C.).
Water won't drain	Drain hose is kinked or improperly connected	<ul style="list-style-type: none"> • Straighten drain hose and make sure washer is not sitting on it. • Top of drain outlet should be less than 8 ft. above floor.

OPERATION	POSSIBLE CAUSES	WHAT TO DO
Washer pauses in cycle	The washer normally pauses between washing steps	
Washer won't operate	Washer is unplugged	• Make sure cord is plugged securely into a working outlet.
	Water supply is turned off	• Turn both hot and cold faucets fully on.
	Controls are not set properly	• Make sure all selections have been made.
	Lid is open	• Close lid and press START/PAUSE .
	Circuit breaker/fuse is tripped/blown	• Check house circuit breakers/fuses. Replace fuses or reset breaker. Washer should have separate outlet.
	Washer has not been turned on	• Press the POWER ON/OFF button.
PERFORMANCE	POSSIBLE CAUSES	WHAT TO DO
Colored spots	Incorrect use of fabric softener	• Check fabric softener package for instructions and follow directions for using dispenser. • Pretreat stain and rewash.
	Dye transfer	• Sort whites or lightly colored items from dark colors.
Grayed or yellowed clothes	Not enough detergent	• Use more detergent (especially with larger loads).
	Hard water	• Use a water conditioner like Calgon brand or install a water softener.
	Water is not hot enough	• Make sure water heater is delivering water at 120°F.–140°F. (48°C.–60°C.).
	Washer is overloaded	• Select load size to match clothes load.
	Dye transfer	• Sort clothes by color. If fabric label states <i>wash separately</i> , unstable dyes may be indicated.
Lint or residue on clothes	Clothes are air or line dried	• If you do not dry your clothes with a clothes dryer, your clothes may retain more lint.
	Incorrect sorting	• Separate lint producers from lint collectors.
	Washing too long	• Wash small loads for a shorter time than larger loads.
	Overloading	• Load clothes no higher than the top row of holes in the washer tub. • Make sure load size selector matches clothes load size.
	Incorrect use of fabric softener	• Check fabric softener package for instructions and follow directions for using dispenser.
Pilling	Result of normal wear on poly-cotton blends and fuzzy fabrics	• While this is not caused by the washer, you can slow the pilling process by washing garments inside out.

Before you call for service...



Troubleshooting Tips

PERFORMANCE (cont'd)	POSSIBLE CAUSES	WHAT TO DO
Snags, holes, tears, rips or excessive wear	Pins, snaps, hooks, sharp buttons, belt buckles, zippers, and sharp objects left in pockets	<ul style="list-style-type: none"> • Fasten snaps, hooks, buttons and zippers. • Remove loose items like pins, objects in pockets and sharp buttons. • Turn knits (which snag easily) inside out.
	Undiluted chlorine bleach	<ul style="list-style-type: none"> • Check bleach package instructions for proper amount. • Never add undiluted bleach to wash or allow clothes to come in contact with undiluted bleach.
	Chemicals like hair bleach or dye, permanent wave solution	<ul style="list-style-type: none"> • Rinse items that may have chemicals on them before washing.
Wrinkling	Improper sorting	<ul style="list-style-type: none"> • Avoid mixing heavy items (like work clothes) with light items (like blouses). • Try a fabric softener.
	Overloading or incorrect water level	<ul style="list-style-type: none"> • Load your washer so clothes have enough room to move freely.
	Repeated washing in water that is too hot	<ul style="list-style-type: none"> • Wash in warm or cold water.
NOISE	POSSIBLE CAUSES	WHAT TO DO
Washer is noisy	Washer is uneven	<ul style="list-style-type: none"> • Level the washer. See <i>Leveling the Washer</i>.
	Washer load is unbalanced	<ul style="list-style-type: none"> • Press the START/PAUSE button to stop the washer, open the lid and redistribute the load evenly. Close the lid and restart.
	Washer is sitting too close to wall (causes knocking during cycle)	<ul style="list-style-type: none"> • Pull washer away from the wall; about 4" is needed.
Dragging noise prior to water filling in the tub	When using the LOAD SENSING feature, the agitator rotates before water fills in the tub	<ul style="list-style-type: none"> • This is normal.
OTHER	POSSIBLE CAUSES	WHAT TO DO
Labels on the exterior of the washer will not peel off cleanly	Occasionally the adhesive used on the labels does not release cleanly	<ul style="list-style-type: none"> • Use a hair dryer set at the lowest heat setting, directing the air at the label for a short amount of time. This will release the adhesive easily, without damaging the surface of the washer.

GE Service Protection Plus™

GE, a name recognized worldwide for quality and dependability, offers you Service Protection Plus™—comprehensive protection on all your appliances—**No Matter What Brand!**

Benefits Include:

- Backed by GE
- All brands covered
- Unlimited service calls
- All parts and labor costs included
- No out-of-pocket expenses
- No hidden deductibles
- One 800 number to call

***We'll Cover Any Appliance.
Anywhere. Anytime.****

You will be completely satisfied with our service protection or you may request your money back on the remaining value of your contract. No questions asked. It's that simple.

Protect your refrigerator, dishwasher, washer and dryer, range, TV, VCR and much more—**any brand!** Plus there's no extra charge for emergency service and low monthly financing is available. Even icemaker coverage and food spoilage protection is offered. You can rest easy, knowing that all your valuable household products are protected against expensive repairs.

Place your confidence in GE and call us in the U.S. toll-free at **800-626-2224** for more information.

*All brands covered, up to 20 years old, in the continental U.S.



Please place in envelope and mail to:

General Electric Company
Warranty Registration Department
P.O. Box 32150
Louisville, KY 40232-2150

Consumer Product Ownership Registration

Dear Customer:

Thank you for purchasing our product and thank you for placing your confidence in us.

We are proud to have you as a customer!

Follow these three steps to protect your new appliance investment:

1

Complete and mail your **Consumer Product Ownership Registration** today. Have the peace of mind of knowing we can contact you in the unlikely event of a safety modification.

2

After mailing the registration below, store this document in a safe place. It contains information you will need should you require service. Our service number is 800 GE CARES (800-432-2737).

3

Read your Owner's Manual carefully. It will help you operate your new appliance properly.

Model Number

Serial Number

Important: If you did not get a registration card with your product, detach and return the form below to ensure that your product is registered, or register online at www.GEAppliances.com.

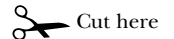

Consumer Product Ownership Registration



Model Number

Serial Number

Mr. Ms. Mrs. Miss

First Name

Last Name

Street Address

Apt. #

E-mail Address

City

State

Zip Code

Date Placed In Use Month

Day

Year

Phone Number - -

Occasionally, we may allow selected companies to send you information.
 Check here if you do not want this information.



GE Appliances

GE Consumer Products
General Electric Company
Louisville, Kentucky
www.GEAppliances.com

GE Washer Warranty.



All warranty service provided by our Factory Service Centers, or an authorized Customer Care® technician. To schedule service, on-line, 24 hours a day, contact us at www.GEAppliances.com, or call 800-GE-CARES.

Staple your receipt here. Proof of the original purchase date is needed to obtain service under the warranty.

For The Period Of: We Will Replace:

One Year From the date of the original purchase	Any part of the washer which fails due to a defect in materials or workmanship. During this full one-year warranty , GE will also provide, free of charge , all labor and in-home service to replace the defective part.
Five Years From the date of the original purchase	The transmission and electronics , if they should fail due to a defect in materials or workmanship. During this additional four-year limited warranty , you will be responsible for any labor or in-home service costs.

What Is Not Covered:

- Service trips to your home to teach you how to use the product.
- Improper installation, delivery or maintenance.
- Failure of the product if it is abused, misused, or used for other than the intended purpose or used commercially.
- Damage after delivery.
- Replacement of house fuses or resetting of circuit breakers.
- Damage to the product caused by accident, fire, floods or acts of God.
- Incidental or consequential damage caused by possible defects with this appliance.

This warranty is extended to the original purchaser and any succeeding owner for products purchased for home use within the USA. In Alaska, the warranty excludes the cost of shipping or service calls to your home.

Some states do not allow the exclusion or limitation of incidental or consequential damages. This warranty gives you specific legal rights, and you may also have other rights which vary from state to state. To know what your legal rights are, consult your local or state consumer affairs office or your state's Attorney General.

Warrantor: General Electric Company, Louisville, KY 40225

Consumer Support.



GE Appliances Website

www.GEAppliances.com

Have a question or need assistance with your appliance? Try the GE Appliances Website 24 hours a day, any day of the year! For greater convenience and faster service, you can now download Owner's Manuals, order parts, catalogs, or even schedule service on-line. You can also "Ask Our Team of Experts™" your questions, and so much more...



Schedule Service

www.GEAppliances.com

Expert GE repair service is only one step away from your door. Get on-line and schedule your service at your convenience 24 hours any day of the year! Or call 800-GE-CARES (800-432-2737) during normal business hours.



Real Life Design Studio

www.GEAppliances.com

GE supports the Universal Design concept—products, services and environments that can be used by people of all ages, sizes and capabilities. We recognize the need to design for a wide range of physical and mental abilities and impairments. For details of GE's Universal Design applications, including kitchen design ideas for people with disabilities, check out our Website today. For the hearing impaired, please call 800-TDD-GEAC (800-833-4322).



Extended Warranties

www.GEAppliances.com

Purchase a GE extended warranty and learn about special discounts that are available while your warranty is still in effect. You can purchase it on-line anytime, or call 800-626-2224 during normal business hours. GE Consumer Home Services will still be there after your warranty expires.

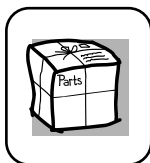

Parts and Accessories

www.GEAppliances.com

Individuals qualified to service their own appliances can have parts or accessories sent directly to their homes (VISA, MasterCard and Discover cards are accepted). Order on-line today, 24 hours every day or by phone at 800-626-2002 during normal business hours.

Instructions contained in this manual cover procedures to be performed by any user. Other servicing generally should be referred to qualified service personnel. Caution must be exercised, since improper servicing may cause unsafe operation.

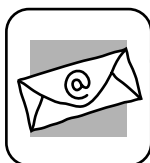

Contact Us

www.GEAppliances.com

If you are not satisfied with the service you receive from GE, contact us on our Website with all the details including your phone number, or write to: General Manager, Customer Relations
GE Appliances, Appliance Park
Louisville, KY 40225



Register Your Appliance

www.GEAppliances.com

Register your new appliance on-line—at your convenience! Timely product registration will allow for enhanced communication and prompt service under the terms of your warranty, should the need arise. You may also mail in the pre-printed registration card included in the packing material, or detach and use the form in this Owner's Manual.