

This Owner's Manual is provided and hosted by [Appliance Factory Parts](#).



Bissell 2070 Owner's Manual

[Shop genuine replacement parts for Bissell 2070](#)



[Find Your Bissell Vacuum Cleaner Parts - Select From 376 Models](#)

----- Manual continues below -----



QuickSteamer®

USER'S GUIDE

1960 SERIES QUICKSTEAMER
2070 SERIES QUICKSTEAMER POWERBRUSH



3 Safety Instructions

4 Product View

5 Assembly/Accessories

6-8 Operations

9 Routine Maintenance

10 Troubleshooting

10 Consumer Services

11 Replacement Parts

12 Warranty



Thanks for buying a BISSELL QuickSteamer®

We're glad you purchased a BISSELL® QuickSteamer® Lightweight Deep Cleaner. Everything we know about floor care went into the design and construction of this complete, high-tech deep cleaning system.

Your QuickSteamer® is well made, and we back it with a limited one-year warranty. We also stand behind it with a knowledgeable, dedicated Consumer Services Department, so, should you ever have a problem, you'll receive fast, considerate assistance.

My great-grandfather invented the floor sweeper in 1876. Today, BISSELL is a global leader in the design, manufacture, and service of high quality homecare products like your QuickSteamer®.

Thanks again, from all of us at BISSELL.

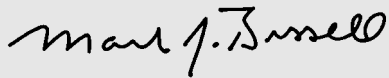

Mark J. Bissell
President and Chief Executive Officer

IMPORTANT SAFETY INSTRUCTIONS

When using an electrical appliance, basic precautions should be observed, including the following:

Read all instructions before using your QUICKSTEAMER®.

To reduce the risk of fire, electric shock or injury:

⚠️ WARNING:

- Do not expose to rain, store indoors.
- Do not leave QUICKSTEAMER® when it is plugged in.
- Do not service QUICKSTEAMER® when it is plugged in.
- Do not use with damaged cord or plug.
- Do not use QUICKSTEAMER® if it has been dropped, damaged, left outdoors or dropped into water, have it repaired at an Authorized Service Center.
- Do not pull or carry by cord, use cord as a handle, close door on cord, pull cord around sharp corners or edges, run appliance over cord, or expose cord to heated surfaces.
- Do not carry the appliance while in use.
- Do not handle QUICKSTEAMER® plug or appliance with wet hands.
- Do not put any object into appliance openings, use with blocked opening, or restrict air flow.
- Do not expose hair, loose clothing, fingers or body parts to openings or moving parts.
- Do not pick up hot or burning objects.
- Do not pick up flammable or combustible materials (lighter fluid, gasoline, kerosene, etc.) or use in the presence of explosive liquids or vapor.
- Do not use appliance in an enclosed space filled with vapors given off by oil base paint, paint thinner, some moth proofing substances, flammable dust, or other explosive or toxic vapors.
- Do not pick up toxic material (chlorine bleach, ammonia, drain cleaner, gasoline, etc.).
- Do not modify the 3-prong grounded plug.
- Do not allow to be used as a toy.
- Do not use for any purpose other than described in this User's Guide.
- Use only on surfaces moistened by cleaning process.
- Connect to a properly grounded outlet only See Grounding Instructions.
- Unplug from outlet when not in use and before conducting maintenance or trouble shooting.

- Do not unplug by pulling on cord.
- Use only manufacturer's recommended attachments.
- Use only cleaning products formulated by BISSELL for use in this appliance.
- Keep openings free of dust, lint, hair, etc.
- Keep appliance on a level surface.
- Turn off all controls before unplugging.
- Unplug by grasping the plug, not the cord.
- Be extra careful when cleaning stairs.
- Close attention is necessary when used by or near children.

WARNING The Power Cord of this unit contains chemicals, including lead, known in the state of California to cause birth defects or other reproductive harm.

Wash hand after handling

SAVE THESE INSTRUCTIONS.

GROUNDING INSTRUCTIONS.

This appliance must be connected to a grounded wiring system. If it should malfunction or break down, grounding provides a safe path of least resistance for electrical current, reducing the risk of electrical shock. The cord for this appliance has an equipment-grounding conductor and a grounding plug. It must only be plugged into an outlet that is properly installed and grounded in accordance with all local codes and ordinances.

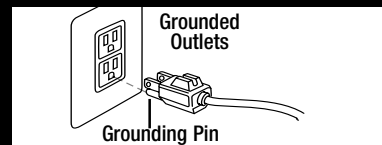

⚠️ WARNING: Improper connection of the equipment-grounding conductor can result in a risk of electrical shock. Check with a qualified electrician or service person if you aren't sure if the outlet is properly grounded. **DO NOT MODIFY THE PLUG.** If it will not fit the outlet, have a proper outlet installed by a qualified electrician. This appliance is designed for use on a nominal 120-volt circuit, and has a grounding attachment plug that looks like the plug in the drawing above. Make certain that the appliance is connected to an outlet having the same configuration as the plug. No plug adapter should be used with this appliance.

This model is for household use only.

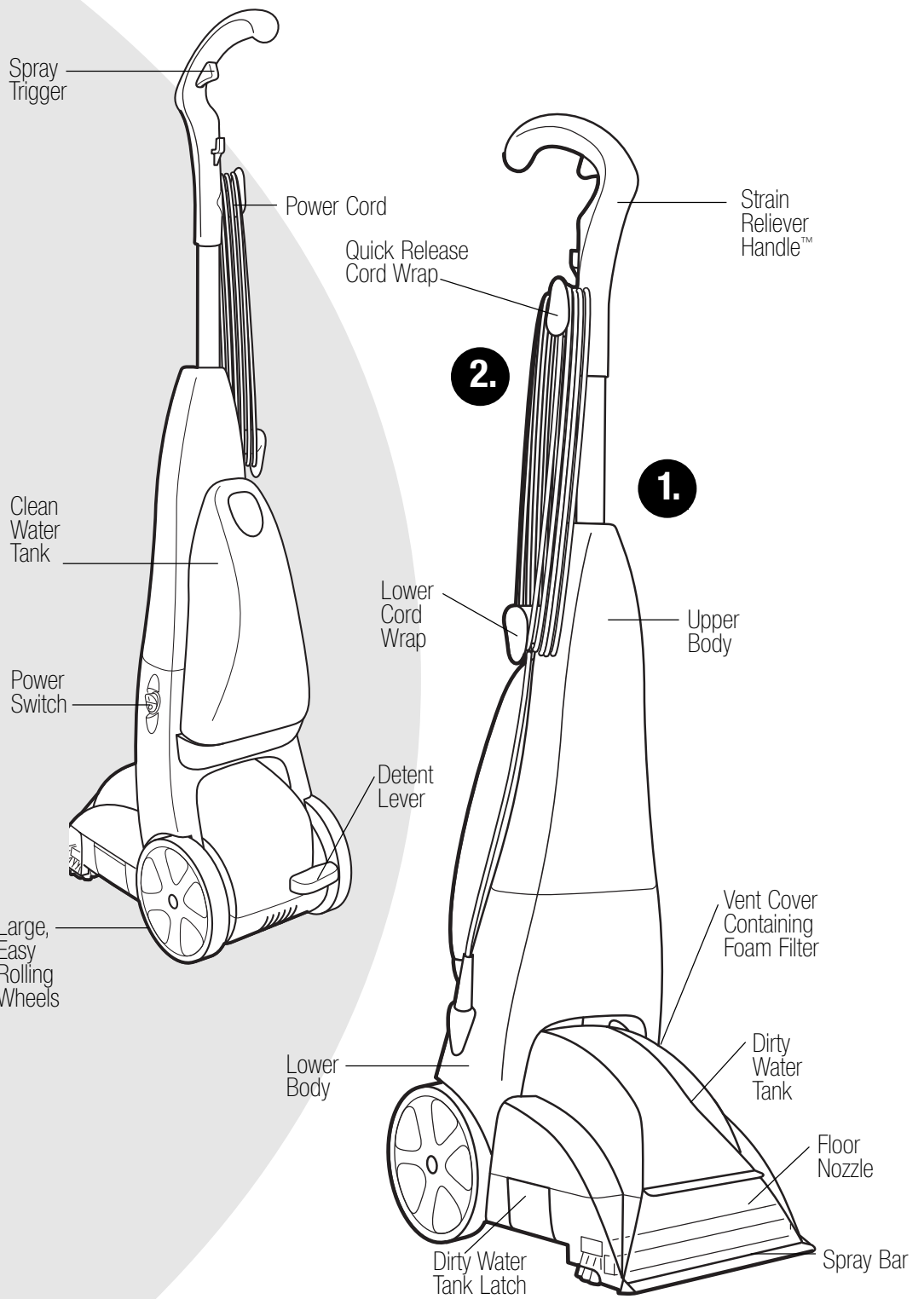

How To Use This Guide

This User's Guide has been designed to help you get the utmost satisfaction from your BISSELL QuickSteamer Lightweight Deep Cleaner. You'll find assembly and operating instructions, safety precautions, as well as maintenance and troubleshooting instructions. Please read this Guide thoroughly before assembling your cleaner.

Pay particular attention to the product diagram, assembly instructions, and part names. Locate and organize all parts before assembly. Familiarize yourself with the parts and where they go. Following this User's Guide will greatly enhance your ability to get the most performance from your BISSELL QuickSteamer for many years.

Your QuickSteamer assembles quickly and easily. The only tool you will need to assemble your deep cleaner is a Phillips Head (⊕) screwdriver.

Your QuickSteamer is packaged with the following items:

Strain Reliever Handle

Upper Body

Lower Body with Dirty Water Tank

Clean Water Tank

2 Long/Partially Threaded Screws

1 Short/Fully Threaded Screw

How To Put It Together

1. Slide Upper Body into Lower Body.
2. Secure with 2 Long/Partially Threaded Screws.
3. Slide Strain Reliever Handle down into Upper Body until it will go no further.
4. Secure with Short/Fully Threaded Screw.
5. Place Clean Water Tank on back of unit.

Other Components

Clean Water Tank - holds 1/2-gallon of hot water and cleaning solution.

Dirty Water Tank - holds 1/2-gallon of dirty water.

Power Cord - for storage, wrap Power Cord around Upper and Lower Cord Wraps, and secure Plug to Cord with molded clip.

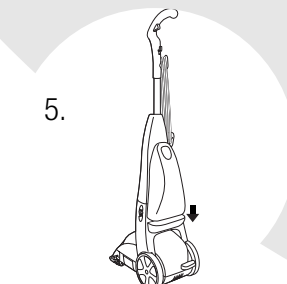
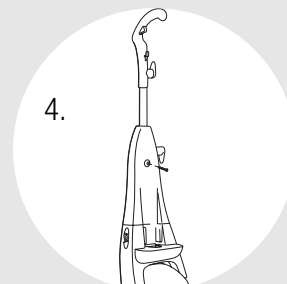
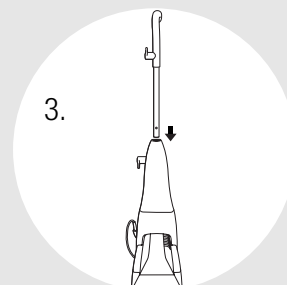
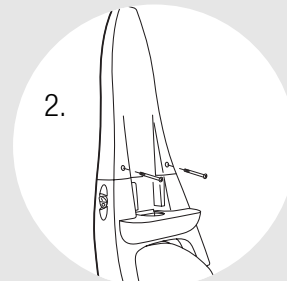
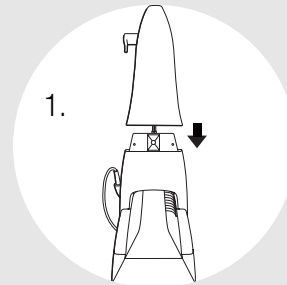

How to use your BISSELL QuickSteamer

How to begin

1. Plan activities to give carpet time to dry.
2. Remove easily moved furniture (chairs, lamps, coffee/cocktail tables, etc.) from room if needed.
3. Vacuum carpet thoroughly.
4. Decide where to begin — and end — your job. Clean in 3' X 4' sections, starting in areas farthest from exit. Plan to leave a path open to empty soiled water and refill cleaner.
5. Carpeting will dry in three to four hours, depending on carpet style and air circulation in room. A floor fan speeds drying.
6. Replace furniture on damp carpeting by placing waxed paper under legs until floor dries completely.

Getting ready

1. Remove the Clean Water Tank by lifting it straight up, then away from the Lower Body.
2. Using the Formula Measuring Cap, add two (2) capfuls of BISSELL® Advanced Cleaning Formulas for Deep Cleaning Machines to the Clean Water Tank. Add 1/2-gallon of hot (NOT boiling) tap water. Fill only to fill line — do not overfill.
3. Replace and turn Formula Measuring Cap clockwise until secure.
4. Place Clean Water Tank on Lower Body.
5. Rotate Quick Release Cord Wrap™ to release the Power Cord and plug into an outlet.
6. Turn Power Switch [located on the side of the Lower Body] to (I) ON.
7. If cleaner starts when first plugged in, switch cleaner OFF (O) until ready for use.



WARNING:

To reduce the risk of fire, use only BISSELL Advanced Cleaning Formulas for Deep Cleaning Machines. Use of cleaning formulas that contain lemon or pine oil may damage this appliance and void warranty. Chemical spot cleaners or solvent-based soil removers should not be used. These products may react with the plastic materials used in your QuickSteamer®, causing cracking or pitting.

Tip:

Always vacuum thoroughly before you deep clean. If possible, move larger furniture to an area you will not be cleaning.

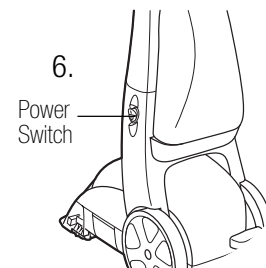
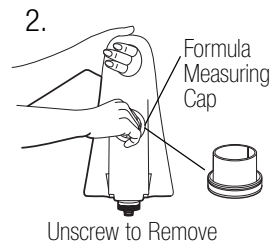

Pre-Treating

Pre-treat stubborn stains and highly soiled carpet in hallways and other high-traffic areas.

1. Spray soiled area with BISSELL® Tough Stain PreCleaner.™
2. Use a stiff-bristled brush to work formula into carpet pile.
3. Wait 3 -5 minutes before deep cleaning.

Tip:

Deep cleaning spots, spills and high traffic areas on a regular basis can prolong carpet life.

Deep Cleaning

1. Turn Power Switch [located on the side of the Lower Body] to (I) ON.
2. With foot, press the Detent Lever on right side of Lower Body.
3. Depress Spray Trigger to spray cleaning solution. Do not overwet.
4. To suction up water, repeat motion over same area without depressing Trigger.
5. Repeat Steps 3 and 4 until no more dirt can be removed.
6. Continue to clean entire carpet, working in 3' x 4' sections.
7. Empty the Dirty Water Tank when dirty water reaches the full line, or when the Clean Water Tank is empty. See page 9 for instructions.
8. If Floor Nozzle stops spraying, turn Power Switch to OFF (O) and check water and cleaning solution levels. Refill if needed.

Tip:

It is recommended that every time your Clean Water Tank is emptied of solution that you empty the contents of the Dirty Water Tank. If the Dirty Water Tank gets too full, you may begin to see foam spitting out of the vent cover. When this happens you will know it is time to empty the Dirty Water Tank.

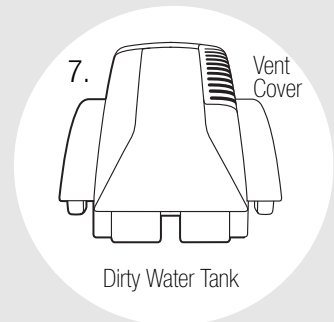

Belt and Brush Removal - 2070 Series only

*QuickSteamer PowerBrush models only

- 1.** Turn the machine off and unplug from wall outlet.
- 2.** Remove clean and dirty water tanks.
- 3.** Lie machine down to access the bottom of the machine.
- 4.** Unscrew the brush cover.
- 5.** Remove the brush end cap and remove belt from brush.
- 6.** Brush can now be removed.
- 7.** Belt can be removed by sliding off the motor pulley.
- 8.** Clean or replace belt. Attach belt to motor pulley and brush, insert brush into right side end cap.
- 9.** Reattach the left end cap.
- 10.** Slide brush with the end cap attached back into place.
- 11.** Replace the brush cover and screw into place.

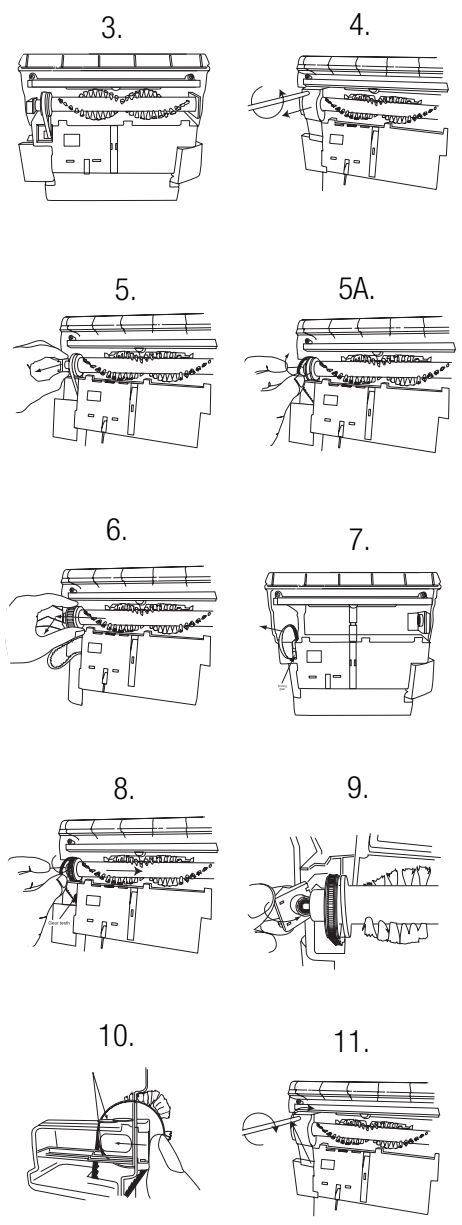

Routine Maintenance

When you're done

1. Turn Power Switch to OFF (O) position.
2. Unplug Power Cord from outlet.
3. Remove and empty Dirty Water Tank.
 - a. Press detent Pedal and tip Handle back, laying it gently on floor.
 - b. Release Dirty Water Tank latches [1 each side] by pulling up from bottom of latch and then out.
 - c. Carefully lift Dirty Water Tank from Lower Body.
 - d. Carry Dirty Water Tank to a toilet or sink. To empty, pour out contents using opening at back of Tank.
 - e. Fill Dirty Water Tank with clean water through the Vent Cover and rinse thoroughly. Discard water.
 - f. Remove lint and hair from Red Gasket in base of unit. (Do not remove gasket)
4. Replace Dirty Water Tank on Lower Body and secure with latches.
5. Wrap Power Cord around Quick Release Cord Wrap™ on side of QUICKSTEAMER®.
6. Wipe all surfaces with a soft cloth. Store cleaner upright in a protected, dry area.

NOTE: You may have cleaning solution remaining in the Clean Water Tank. You may store your QuickSteamer this way for the next cleaning task, but never keep soiled solution in the Water Tank.

! WARNING:
To reduce the risk of injury from moving parts and/or electrical shock, turn Power Switch OFF and disconnect polarized plug from electrical outlet before performing troubleshooting checks.

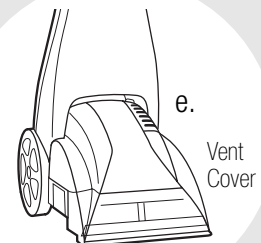
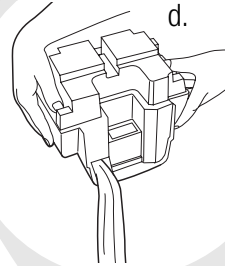
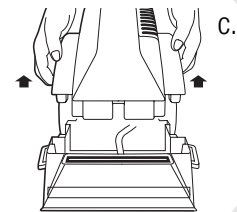
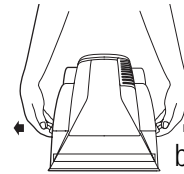
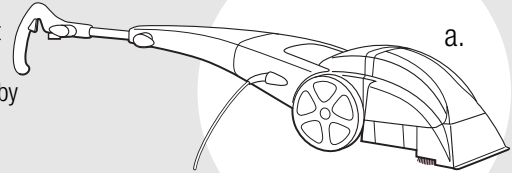

CAUTION:
Do not store unit where freezing may occur. Damage to internal components may result.

Trouble Shooting

Reduced spray or no spray.

Possible Causes

Clean Water Tank empty

Remedies

Refill Tank with water and formula

Deep Cleaner not picking up cleaning solution.

Possible Causes

Dirty Water Tank not aligned/secured

Dirty Water Tank is full

Remedies

Check Tank for proper alignment and secure with side latches

Empty Tank

BISSELL Consumer Services

For information about repairs or replacement parts, or questions about your warranty, call:

BISSELL Consumer Services

1-800-237-7691

Monday - Friday 8 a.m. — 10 p.m. ET

Saturday 9 a.m. — 8 p.m. ET

Or write:

BISSELL Homecare, Inc

PO Box 3606

Grand Rapids, MI 49501

ATTN: Consumer Services

Or visit the BISSELL website - www.bissell.com

When contacting BISSELL, have model number of unit available.

Please record your Model Number: _____

Please record your Purchase Date: _____

NOTE: Please keep your original sales receipt. It is your warranty.

Replacement parts - BISSELL QuickSteamer

Item Part No. Part Name

QuickSteamer– 1960 Series

1	203-5601	Handle Assembly
2	203-5602	Cross Action Brush
3	203-5603	Clean Water Tank
4	203-5604	Dirty Water Tank
5	603-7822	Bare Floor Tool*

QuickSteamer PowerBrush– 2070 Series

1	603-2010	Handle Assembly
3	603-2009	Clean Water Tank
4	603-2008	Dirty Water Tank
6	603-2006	Dirt Lifter PowerBrush
7	603-2007	Belt
8	0710	Fiber Cleansing Formula™ 48 oz
9	0720	Multi-Allergen Removal™ Formula 48 oz
10	044	Tough Stain PreCleaner™

* Not all parts included with every model.

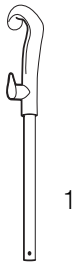

1

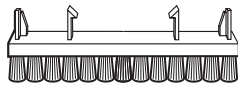

2

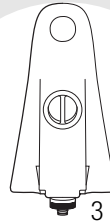

3

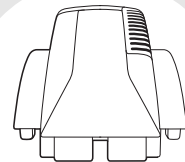

4

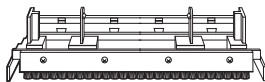

5

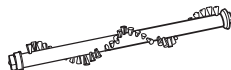

6



7



8



9



10

About Your Warranty

This warranty gives you specific legal rights, and you may also have other rights which may vary from state to state. If you need additional instruction regarding this warranty or have questions regarding what it may cover, please contact BISSELL Consumer Services by E-mail, telephone, or regular mail as described below.

Limited **One** Year Warranty

Subject to the *EXCEPTIONS AND EXCLUSIONS identified below, upon receipt of the product BISSELL Homecare Inc. will repair or replace (with new or remanufactured components or products), at BISSELL's option, free of charge from the date of purchase by the original purchaser, for one year any defective or malfunctioning part.

See information below on "If your BISSELL product should require service".

This warranty applies to product used for personal, and not commercial or rental service. This warranty does not apply routine maintenance components such as filters, belts, or brushes. Damage or malfunction caused by negligence, abuse, or use not in accordance with the User's Guide is not covered.

If your BISSELL product should require service:

Contact BISSELL Consumer Services to locate a BISSELL Authorized Service Center in your area.

If you need information about repairs or replacement parts, or if you have questions about your warranty, contact BISSELL Consumer Services.

Website or E-mail:

www.bissell.com

Use the "Customer Services" tab.

Or Call:

BISSELL Consumer Services

1-800-237-7691

Monday - Friday 8 a.m. - 10 p.m. ET

Saturday 9 a.m. - 8 p.m. ET

Or write:

BISSELL Homecare Inc.

PO Box 3606

Grand Rapids MI 49501

ATTN: Consumer Services

BISSELL HOME CARE, INC. IS NOT LIABLE FOR INCIDENTAL OR CONSEQUENTIAL DAMAGES OF ANY NATURE ASSOCIATED WITH THE USE OF THIS PRODUCT. BISSELL'S LIABILITY WILL NOT EXCEED THE PURCHASE PRICE OF THE PRODUCT.

Some states do not allow the exclusion or limitation of incidental or consequential damages, so the above limitation or exclusion may not apply to you.

*EXCEPTIONS AND EXCLUSIONS FROM THE TERMS OF THE **LIMITED** WARRANTY

THIS WARRANTY IS EXCLUSIVE AND IN LIEU OF ANY OTHER WARRANTIES EITHER ORAL OR WRITTEN. ANY IMPLIED WARRANTIES WHICH MAY ARISE BY OPERATION OF LAW, INCLUDING THE IMPLIED WARRANTIES OF MERCHANTABILITY AND FITNESS FOR A PARTICULAR PURPOSE, ARE LIMITED TO THE ONE YEAR DURATION FROM THE DATE OF PURCHASE AS DESCRIBED ABOVE.

Some states do not allow limitations on how long an implied warranty lasts, so the above limitation may not apply to you.



©2003 BISSELL HOME CARE, Inc.
Grand Rapids, Michigan
All rights reserved. Printed in USA.
Part Number 603-5600
Rev 3/03

Visit our website at:
www.bissell.com