

This Owner's Manual is provided and hosted by [Appliance Factory Parts](#).



Bissell 7700 Owner's Manual

[Shop genuine replacement parts for Bissell 7700](#)



[Find Your Bissell Vacuum Cleaner Parts - Select From 376 Models](#)

----- Manual continues below -----

Big Green Complete™

USER'S GUIDE 7700 SERIES



3 Safety Instructions

4-5 Product View

6 Assembly

7-8 Special Features

8-14 Operation

14-15 Maintenance and Care

16 Troubleshooting

17 Consumer Services

18-19 Replacement Parts

20 Warranty

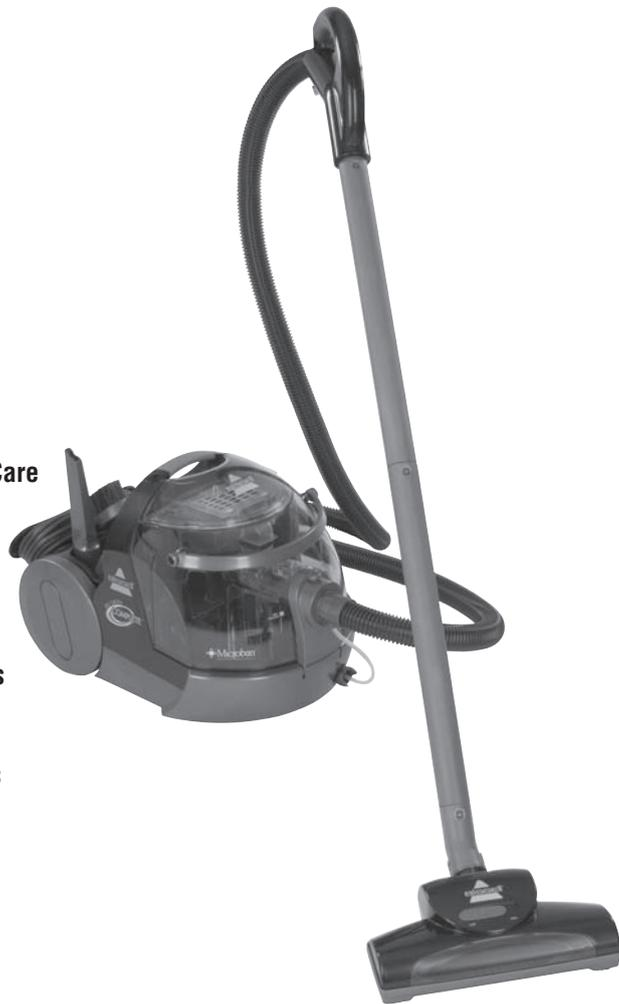

Thanks for buying a BISSELL Big Green Complete

We're glad you purchased a BISSELL Big Green Complete cleaning system. Everything we know about floor care went into the design and construction of this complete, high-tech home cleaning system.

Your Big Green Complete is well made, and we back it with a limited one-year warranty. We also stand behind it with a knowledgeable, dedicated Consumer Services department, so, should you ever have a problem, you'll receive fast, considerate assistance.

My great-grandfather invented the floor sweeper in 1876. Today, BISSELL is a global leader in the design, manufacture, and service of high quality homecare products like your Big Green Complete.

Thanks again, from all of us at BISSELL.



Mark J. Bissell
President and Chief Executive Officer



IMPORTANT SAFETY INSTRUCTIONS

When using an electrical appliance, basic precautions should be observed, including the following:

Read all instructions before using your BIG GREEN COMPLETE

⚠ WARNING: To reduce the risk of fire, electric shock, or injury:

- Do not immerse.
- Use only on surfaces moistened by cleaning process.
- Always connect to a properly grounded outlet.
- See Grounding Instructions.
- Unplug from outlet when not in use and before conducting maintenance or troubleshooting.
- Do not leave machine when it is plugged in.
- Do not service machine when it is plugged in.
- Do not use with damaged cord or plug.
- If appliance is not working as it should, has been dropped, damaged, left outdoors, or dropped into water, have it repaired at an authorized Service Center.
- Use indoors only.
- Do not pull or carry by cord, use cord as a handle, close door on cord, pull cord around sharp corners or edges, run appliance over cord, or expose cord to heated surfaces.
- Unplug by grasping the plug, not the cord.
- Do not handle plug or appliance with wet hands.
- Do not put any object into appliance openings, use with blocked opening, or restrict air flow.
- Do not expose hair, loose clothing, fingers or body parts to openings or moving parts.
- Do not pick up hot or burning objects.
- Do not pick up flammable or combustible materials (lighter fluid, gasoline, kerosene, etc.) or use in the presence of explosive liquids or vapor.
- Do not use appliance in an enclosed space filled with vapors given off by oil base paint, paint thinner, some moth proofing substances, flammable dust, or other explosive or toxic vapors.
- Do not pick up toxic material (chlorine bleach, ammonia, drain cleaner, gasoline, etc.).
- Do not modify the 3-prong grounded plug.
- Do not allow to be used as a toy.
- Do not use for any purpose other than described in this User's Guide.
- Do not unplug by pulling on the cord.
- Use only manufacturer's recommended attachments.
- Always install float before any wet pick up operation.
- Use only cleaning products formulated by BISSELL for use in this appliance to prevent internal component damage. See the cleaning fluid section of this guide.
- Keep openings free of dust, lint, hair, etc.
- Do not point attachment nozzle at people or animals
- Keep appliance on a level surface.
- Turn off all controls before unplugging.

- Unplug before attaching the air powered floor TurboBrush.®
- Be extra careful when cleaning stairs.
- Close attention is necessary when used by or near children.
- Do not use without filters in place.
- **WARNING:** The power cord on this product contains lead, a chemical known to the State of California to cause birth defects or other reproductive harm.
WASH HANDS AFTER HANDLING.

SAVE THESE INSTRUCTIONS.

THIS MODEL IS FOR HOUSEHOLD USE ONLY.
Commercial use of this unit voids the manufacturer's warranty.

GROUNDING INSTRUCTIONS

This appliance must be connected to a grounded wiring system. If it should malfunction or break down, grounding provides a safe path of least resistance for electrical current, reducing the risk of electrical shock. The cord for this appliance has an equipment-grounding conductor and a grounding plug. It must only be plugged into an outlet that is properly installed and grounded in accordance with all local codes and ordinances.

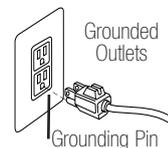

⚠ WARNING: Improper connection of the equipment-grounding conductor can result in a risk of electrical shock. Check with a qualified electrician or service person if you aren't sure if the outlet is properly grounded. **DO NOT MODIFY THE PLUG.** If it will not fit the outlet, have a proper outlet installed by a qualified electrician. This appliance is designed for use on a nominal 120-volt circuit, and has a grounding attachment plug that looks like the plug in the drawing above. Make certain that the appliance is connected to an outlet having the same configuration as the plug. No plug adapter should be used with this appliance.

Product view - water filtrated vacuum mode



Optional Accessories:

Some or all of these may have come with your unit. These items are available for purchase. To order replacement parts, additional tools or formulas, please refer to page 17-18.



Air Powered Floor TurboBrush®



Multi-Surface Floor Tool



5" Brush



Crevice Tool - (works for wet cleaning too)



Dust Brush



Carpet Deep Cleaning Tool



Hard Floor Tool (Shown with Microfiber Pad)



4" Upholstery Tool



Drain Cleaner

Product view - wet cleaning mode



Keep plenty of genuine BISSELL deep cleaning formulas on hand so you can clean whenever it fits your schedule. Always use genuine BISSELL deep cleaning formulas. Non-BISSELL cleaning solutions may harm the machine and void the warranty.

BISSELL Formulas:

These items are available for purchase. To order replacement parts, additional tools or formulas, please refer to page 17-18.



43 oz. 3X Concentrated Fiber Cleansing Formula™ with Scotchgard™ Protector

48 oz. Fiber Cleansing Formula™ with Scotchgard™ Protector

48 oz. Multi-Allergen Removal™ Formula™ with Scotchgard™ Protector

48 oz. Pet Odor and Soil Removal™ Formula with Scotchgard™ Protector

48 oz. Natural Orange Extract Formula with Scotchgard™ Protector

48 oz. BISSELL Lavender Essence Formula with Scotchgard™ Protector

32 oz. Hard Floor Solutions™ Formula

www.bissell.com



800.237.7691

5

How to use this guide

This user's guide has been designed to help you get the utmost satisfaction from your BISSELL Big Green Complete. You'll find assembly and operating instructions, safety precautions, as well as maintenance and troubleshooting instructions. Please read this user's guide thoroughly before assembling your product.

Pay particular attention to the product diagram, assembly instructions, and part names. Locate and organize all parts before assembly. Familiarize yourself with the parts and where they go. Following this user's guide will greatly enhance your ability to get the most performance from your BISSELL Big Green Complete for many years.



WARNING:

Do not plug in your cleaner until you have completely assembled it per the following instructions and are familiar with all instructions and operating procedures.

Assembly

Your Big Green Complete is easy to assemble and requires no tools:

1. Attach hose to Quick Release™ Hose Door by inserting fitted end and turning clockwise until you hear it click into the locked position.
2. Attach hose solution line to unit by inserting fitted end into the machine. Turn clockwise until it snaps into place.
3. Snap the two wand pieces together by lining up tabs with holes and clicking together. Be sure that the wand piece with the adaptor (see figure 4a) is the one you will attach to the tool. Attach assembled wand to grip using the same technique.
4. Snap the desired tool on the end of the wand. Place wand adaptor into the wand caddy on the side of the unit.
5. Place either tool caddy or solution tank (if wet clean mode is desired) onto the back of the machine.

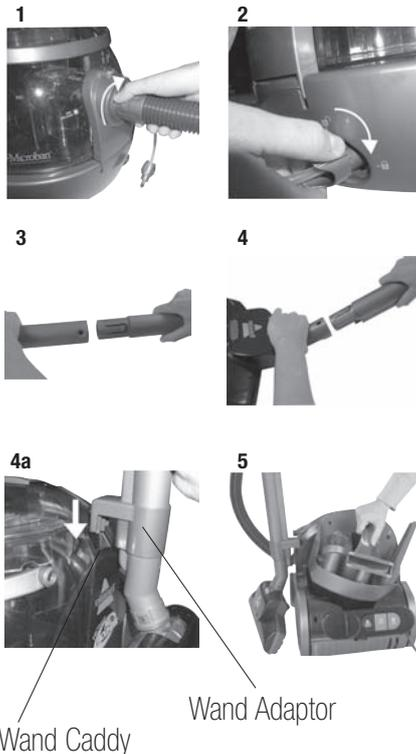

Special features of your BISSELL Big Green Complete

Your BISSELL Big Green Complete is a complete home cleaning system. Not only does it come with many unique features, it has been designed with you, the customer, in mind.

Built-in heater

Big Green Complete models all feature a patented built-in heater which heats hot tap water up to 25 degrees hotter to safely optimize cleaning effectiveness. The heater will never allow the cleaning solution temperature to exceed 190 degrees. The heater switch on the back of the machine controls the heater so you have the option to turn off the heat if you want to.

Microban®

Microban antimicrobial product protection fights the growth of odor causing bacteria, mold and mildew in the machine. Keeps it cleaner and fresher between uses.

Hard floor tool

BISSELL's unique hard floor tool uses a combination of gentle scrubbing action and strong suction to clean your hard floor surfaces and leave them dry within minutes.

Hard floor microfiber pad

Soft and gentle microfiber pad is washable and re-usable, time and time again.

Tool caddy

The onboard tool caddy can be used to store any tools you are not currently using.

Cleaning tools

Your Big Green Complete comes with a variety of advanced tools, each one just right for a specific job. Some of these tools have multiple uses.

Air powered floor TurboBrush:

Perfect for carpets and rugs, this air-powered floor TurboBrush comes with an air flow adjuster. When using on normal length carpets and rugs set the selector to Low. For especially thick or long carpet or rugs, switch the selector to High. Additional airflow will be brought in from the top of the brush in the High position.



Top View

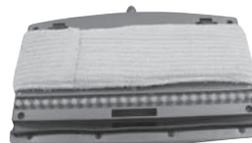

Bottom View



Special features of your BISSELL Big Green Complete

Cleaning tools (continued)

Multi-surface floor tool:

May be used on both carpet/rugs or hard floor surfaces. For use on carpets, make sure the tab is in the down position . This will hide the soft outer brushes. For hard floor surfaces, press the opposite tab in the down position . This will engage the soft outer brushes.

Crevice tool: May be used for both dry vacuuming or wet cleaning.

NOTE: In wet cleaning mode the crevice tool will spray water and cleaning solution. Take care not to press the trigger when in water filtrated vacuum mode.



Quick Release™ Hose Door

The handy Quick Release™ Hose Door ensures that the machine's hose never rests on your carpet or hard floors, keeping them clean and dry while filling or emptying the tanks.

Wand caddy

Perfect for storage or when you take a break from cleaning, the wand caddy holds the grip, wands and tools firmly in place.

Operation

Vacuuming

Getting Ready

In order to maximize the cleaning and filtration power of the Big Green Complete make sure there is always water in the collection tank. Fill with clean tap water up to the tank fill line. Vacuuming without water in the collection tank will require more frequent washing of the filters to prevent build up of dust and other particles, which may cause damage to the motor.

1. If desired, make sure the tool caddy is in the back of the machine. Store appropriate vacuuming tools as needed.
2. Attach desired tool to end of wand (or directly to grip).

Operation

Getting Ready (continued)

3. Remove the collection tank from the unit by opening the Quick Release Hose Door and lifting the tank straight up by the handle.
4. Remove the top lid from the collection tank and set aside.
5. Fill the collection tank to the fill line (located on side of tank) with clean, cold water.
6. Replace the top lid back onto the top of the collection tank.
7. Set the collection tank back in the machine.
8. Select "WATER FILTER VACUUM" with the mode selector.
9. Close the Quick Release Hose Door tightly until it clicks into the locked position.
10. Plug into a proper outlet and press the ON/OFF button down into the ON position.

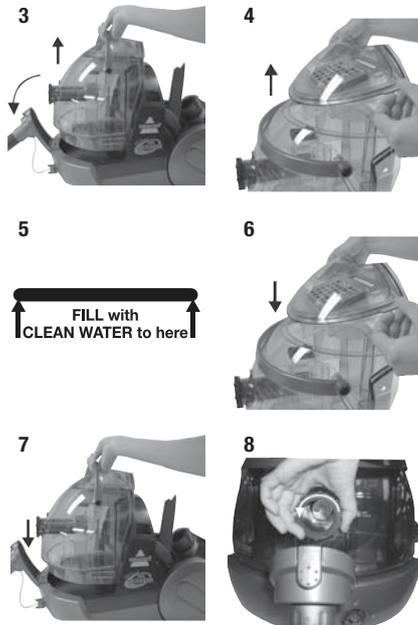

Emptying the tank

1. Open the Quick Release™ Hose Door and remove the collection tank by lifting straight up with the tank handle.
2. Remove the top lid from the collection tank and set it aside.
3. Empty dirty water into a sink or toilet, or outside. Pour the dirty water out from the corner of the tank. Rinse out the tank thoroughly.
4. Refill the tank if needed and replace the top lid back onto the top of the collection tank.
5. Set the collection tank back in the machine.
6. Close Quick Release hose door tightly until it clicks into locked position.
7. If finished vacuuming, refer to the Maintenance and care section starting on page 14.

Wet cleaning

Before you clean

1. Plan activities to give your carpets time to dry.
2. Thoroughly dry vacuum the area to be cleaned.
3. Plan your cleaning route to leave an exit path. It is best to begin cleaning in the corner farthest from your exit.

Operation

Getting ready to wet clean

NOTE: Remove tool caddy if in place.

1. Attach the desired wet cleaning tool to end of wand or grip.
2. Open the Quick Release™ Hose Door and select "WET CLEAN" with the mode selector.
3. Place the clean solution tank on a flat surface.
4. Fill the solution tank by first unscrewing the measuring cap. Always use genuine BISSELL formulas to maximize cleaning and for the safety of your machine. Fill tank to fill line with hot tap water. Add two full measuring caps of formula. Screw measuring cap tightly back onto the solution tank.
5. Place the solution tank back in the machine.
6. Make sure the float is in place. To install, slide float into the channel located on "Fill Line" side of the collection tank. There is only one way to properly install the float.
7. Plug into a proper outlet and press the ON/OFF, wet clean and heater (if desired) buttons down into the ON position.

Note: Allow one minute for the built-in heater to warm up before cleaning. The Big Green Complete will be fully warmed and will provide optimal performance after one minute in the heater ON position.

Tip:

Move furniture to another area if cleaning an entire room.

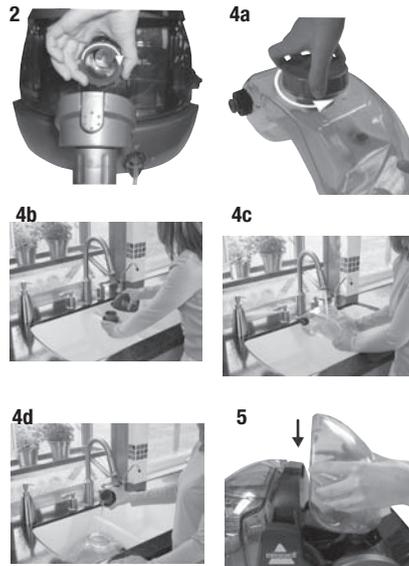

Operation

Carpet Cleaning

1. Attach carpet deep cleaning tool to end of wand.
2. Place carpet deep cleaning tool directly on carpet. Pull the spray trigger to spray cleaning solution while pulling the wand towards you.
3. Keeping nozzle of the carpet deep cleaning tool firmly against the carpet surface, continue to make slow forward and backward wet passes until no more dirt can be removed.
Do not overwet.
4. Release spray trigger and make slow forward and backward passes over the same area to remove any residual dirty water.
5. Repeat wet cleaning passes until water being pulled up appears clean.
6. Continue passes without pressing the spray trigger until you can't see any more water being pulled up.
7. Continue to clean entire carpet working in 3' by 3' sections.
8. If machine loses suction, stop spraying and check the collection tank level. Empty if necessary.
9. If the machine stops spraying turn off wet clean button immediately and check the solution tank level.

NOTE: Never run in wet clean mode when the clean water formula tank is dry or missing.

ATTENTION:

Some Berber carpets have a tendency to fuzz with wear. Repeated strokes in the same area with an ordinary vacuum or deep cleaner may aggravate this condition.

Operation

When you are finished

1. Turn off the heater, wet clean, and power buttons.
2. Remove the collection tank from the unit by opening the quick release hose holder and lifting the tank straight up by the handle.
3. Remove the top lid from the collection tank and set it aside.
4. Empty dirty water into a sink, toilet or outside. Pour the dirty water out from the corner of the tank. Rinse out the tank thoroughly.
NOTE: You may leave the solution tank with water and formula in it so you are ready for the next use.
5. Allow all parts to dry before storing.

Hard floor cleaning

1. See "Getting Ready to Wet Clean" on Page 10.
2. Be sure to use BISSELL Hard Floor Solutions in the solution tank for hard floor cleaning. Fill the formula tank by first unscrewing the measuring cap. Always use genuine BISSELL formulas to maximize cleaning and for the safety of your machine. Fill tank to fill line with hot tap water. Add one full cap of formula. Screw measuring cap tightly back onto the solution tank.
3. Set the solution tank back in the machine.
4. Attach microfiber pad to quick dry hard floor tool by attaching to the Velcro strips on the top of the tool.
5. Attach the hard floor tool to end of the wand.
6. Place tool directly on the hard floor surface, resting on the pad.
7. Squeeze the spray trigger to moisten the pad with cleaning solution.
Caution: Do not oversaturate.
8. Move the tool back and forth across the floor to clean. Squeeze spray trigger as needed.
9. Tilt the tool forward and pull back. This will create the best suction and will help get the hard floor surface as dry as possible.
10. Continue until room is complete.
11. See "When you are finished" instructions above.
12. Be sure to remove the microfiber pad and clean it by hand or machine wash as needed. Allow it to dry completely before next use.

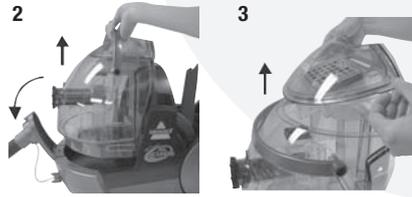

CAUTION:

Your Big Green complete is designed to clean hard flooring such as ceramic tile, vinyl, laminate, marble, stone and sealed hard wood floors. Do not use on any unsealed hard floor surfaces.



Operation

Upholstery cleaning

Your Big Green Complete comes with special tools for vacuuming and wet cleaning upholstery, stairs and more.

1. **Important!** If using to wet clean upholstery, check the upholstery tags before proceeding.
 - a. Check manufacturer's tag before cleaning. "W" or "WS" on the tag means you can use your Big Green Complete. If the tag is coded with an "X" or an "S" (with a diagonal stripe through it), or says "Dry Clean Only", do not proceed with deep cleaning. Do not use on velvet or silk. If manufacturer's tag is missing or not coded, check with the furniture maker or the furniture dealer.
 - b. Check for colorfastness in an inconspicuous place.
 - c. If possible, check upholstery stuffing. Colored stuffing may bleed through fabric when wet.
 - d. Plan activities to allow upholstery time to dry.
 - e. Vacuum thoroughly.
2. Refer to the "Getting Ready to Wet Clean" on page 10.
3. Attach the desired wet cleaning tool to the wand or grip.
4. Clean by pressing the spray trigger to spray solution onto the area to be cleaned. Slowly move the tool back and forth over the soiled surface. Release the spray trigger to suction soiled water. Continue to clean the area, working in small sections, until no more dirt can be removed. Suction as needed to remove as much water as possible.
Caution: Do not overwet.
5. Remove and rinse tools in clean, running water. Dry and put away.
6. See "When you are finished" instructions on page 12.



Manufacturer's tag

Tip:

It is recommended that you suction clean water from the tap to rinse out the hose.

Operation

Cleaning fluid section

Keep plenty of genuine BISSELL Formula on hand so you can clean and protect whenever it fits your schedule. Always use genuine BISSELL deep cleaning formulas.



WARNING:

To reduce the risk of fire and electric shock due to internal component damage, use only BISSELL Deep Cleaning Formulas intended for use with the deep cleaner. Non-BISSELL cleaning formula may harm the machine and void the warranty.



43 oz. 3X Concentrated Fiber Cleansing Formula™ with Scotchgard™ Protector

48 oz. Fiber Cleansing Formula™ with Scotchgard™ Protector

48 oz. Multi-Allergen Removal™ Formula™ with Scotchgard™ Protector

48 oz. Pet Odor and Soil Removal™ Formula with Scotchgard™ Protector

48 oz. Natural Orange Extract Formula with Scotchgard™ Protector

48 oz. BISSELL Lavender Essence Formula with Scotchgard™ Protector

32 oz. Hard Floor Solutions™ Formula

Maintenance and care

Machine storage

Once your cleaning is complete make sure the dirty water from the collection tank is emptied. Rinse out and dry before the next use. For wet cleaning, the solution tank can be left filled and ready to use.

Note: Store your Big Green Complete in a protected dry area. Since this product uses water it must not be stored where there is a danger of freezing. Freezing will damage the internal components and void the warranty.

Maintenance and care

Machine care

For best results, a few simple steps can assure your machine is well maintained after your cleaning is complete.

1. Press all buttons OFF. Unplug the machine and wrap the cord.
2. After emptying the dirty water from the collection tank, rinse it out thoroughly with hot water. Remove all inner parts (water filtration tower and mode selector) if desired. Rinse them and allow to dry before returning into tank.

Note: To remove inner parts, turn mode selector to remove. Pull mode selector straight out towards you. The water filtration tower can now be taken out through the top of the tank.

3. For wet cleaning, remove and clean all tools that were used. Allow to dry before storing.
4. Remove the hose, taking care to keep both ends up to avoid spilling. Dump out any remaining water and flush clean with hot tap water. Allow to dry before storing.
5.
 - a. **Pre-motor filter:** Take apart the top lid by pulling the tab away from the separator. Inspect the foam filter. If dirty, rinse clean and allow to dry before returning it to the machine. Re-assemble the top lid by placing the filter in its spot and re-attaching the separator. Use care to make sure the "T" pieces are lined up under the shallow grooves on the top lid itself. For replacement of this part, see pages 18-19.
 - b. **HEPA Media filter:** This filter is located at the back of the machine, underneath the Quick Release Cord Wrap. Use one finger to depress the latch and pull the door down. Open towards you and down to the ground. Use two hands to remove the filter from its slot. If dirty, rinse clean and allow to dry before returning it to the machine. Make sure the filter door is fully closed prior to operating the machine. For replacement of this filter see pages 18-19.

! WARNING:
To reduce the risk of fire, electric shock or injury unplug from outlet before servicing.



Water Filtration Tower



Mode Selector



Troubleshooting

Reduce Spray or No Spray

Possible Cause

1. Make sure power is on
2. Solution tank may be empty
3. Tank may not be seated properly
4. Hose solution line may be disconnected
5. Wet clean is not turned on

Machine is not suctioning

Possible Cause

1. Collection tank may not be placed properly
2. Collection tank may not be assembled properly
3. Wand tool connections are not tight
4. Collection tank is full
5. Float has tripped
6. Pre-motor filter is dirty

Built-in heater light does not illuminate

Possible Cause

1. The heater button has not been depressed
2. The ON/OFF button has not been depressed



WARNING:

To reduce the risk of fire, electric shock or injury unplug from outlet before servicing.

Remedies

1. Press power button if needed
2. Fill tank according to directions
3. Turn ON/OFF, heater and wet clean button off. Remove and reseat tank
4. Check connection at front of machine
5. Depress wet clean button to turn on

Remedies

1. Open Quick Release™ Hose Door, lift out tank and re-seat. Re-latch Quick Release™ Hose Door
2. Check to make sure the top lid is properly seated
3. Check all connections (At grip, wand and tool) Push tight if necessary
4. Empty collection tank by following instruction on page 9
5. Check to see if tank needs to be emptied. Make sure float is down towards bottom of tank
6. Remove top lid. Remove and clean pre-motor filter by following instructions on page 15 Filter must be completely dry before using again

Remedies

1. Depress the heater button
2. Depress the ON/OFF button

Other maintenance or service not included in the manual should be performed by an authorized service representative.

Thank you for selecting a BISSELL product.

Please do not return this product to the store.



BISSELL Consumer Services

For information about repairs or replacement parts, or questions about your warranty, call:

BISSELL Consumer Services
1-800-237-7691

Monday - Friday 8 a.m. — 10 p.m. EST

Saturday 9 a.m. — 8 p.m. EST

Or write:

BISSELL HOMECARE, INC

PO Box 3606

Grand Rapids MI 49501

ATTN: Consumer Services

Or visit the BISSELL website - **www.bissell.com**

When contacting BISSELL, have model number of unit available.

Please record your Model Number: _____

Please record your Purchase Date: _____

NOTE: Please keep your original sales receipt. It provides proof of date of purchase in the event of a warranty claim. See Warranty on page 20 for details.



Replacement parts - BISSELL Big Green Complete

Below a list of common replacement parts*. While not all of these parts may have come with your specific machine, all are available to you for purchase, if desired.

Item	Part No.	Part Name
1	203-7063	Multi-Surface Floor Tool
2	203-7064	Air Powered Floor TurboBrush
3	203-7073	5" Brush
4	203-7066	Wand
5	203-7067	Adaptor
6	203-7068	Crevice Tool
7	203-7069	Dust Brush
8	203-7070	Carpet Deep Cleaning Tool
9	203-7071	Carpet Deep Cleaning Tool Brush Strip
10	203-7072	Carpet Deep Cleaning Tool Adaptor
11	203-7065	4" Upholstery Tool
12	203-7074	Quick Dry Hard Floor Tool (pads not included)
13	203-7076	Hard Floor Microfiber Pads (2 Pack)
14	203-7077	Drain Cleaner
15	203-7078	Tool Caddy
16	203-7079	Hose Grip Assembly
17	203-7080	Measuring Cap
18	203-7082	Pre-Motor Filter
19	203-7083	HEPA Media Filter
20	203-7084	Solution Tank
21	203-7085	Small cap/insert
22	203-7086	HEPA Filter Door
23	203-7087	Float
24	203-7088	Diverter
25	203-7089	Water Filtration Tower
26	203-7090	Water Filtration Tower Gasket
27	203-7091	Separator with Filter
28	203-7092	Top Lid Assembly
29	203-7093	Lid
30	203-7094	Collection Tank w/Microban
31	203-7095	Collection Tank Assembly w/Microban
32	203-7098	Motor Duct Gasket
33	203-7099	Quick Release™ Hose Door™ Assembly
34	203-7100	Carry Handle Assembly
35	203-7102	Caster Wheel
36	0716	3X Concentrated Fiber Cleansing Formula 48 oz.
37	710A	Fiber Cleansing Formula 48 oz.
38	720A	Multi-Allergen Removal Formula 48 oz.
39	730A	Pet Odor and Soil Removal Formula 48 oz.
40	0740	Natural Orange Extract Formula 48 oz.
41	0750	Lavender Essence Formula 48 oz.
42	0484	Hard Floor Solutions 32 oz.

***Not all parts are included with every model.**

Replacement parts - BISSELL Big Green Complete



Warranty - BISSELL Big Green Complete

This warranty gives you specific legal rights, and you may also have other rights which may vary from state to state. If you need additional instruction regarding this warranty or have questions regarding what it may cover, please contact BISSELL Consumer Services by E-mail, telephone, or regular mail as described below.

Limited One Year Warranty

Subject to the ***EXCEPTIONS AND EXCLUSIONS** identified below, upon receipt of the product BISSELL Homecare, Inc. will repair or replace (with new or remanufactured components or products), at BISSELL's option, free of charge from the date of purchase by the original purchaser, for one year any defective or malfunctioning part.

See information below on "If your BISSELL product should require service".

This warranty applies to product used for personal, and not commercial or rental service. This warranty does not apply to fans or routine maintenance components such as filters, belts, or brushes. Damage or malfunction caused by negligence, abuse, neglect, unauthorized repair, or any other use not in accordance with the User's Guide is not covered.

If your BISSELL product should require service:

Contact BISSELL Consumer Services to locate a BISSELL Authorized Service Center in your area.

If you need information about repairs or replacement parts, or if you have questions about your warranty, contact BISSELL Consumer Services.

Website or E-mail:

www.bissell.com

Use the "Customer Services" tab.

Or Call:

BISSELL Consumer Services

1-800-237-7691

Monday - Friday 8 a.m. - 10 p.m. ET

Saturday 9 a.m. - 8 p.m. ET

Or write:

BISSELL Homecare, Inc.

PO Box 3606

Grand Rapids MI 49501

ATTN: Consumer Services

BISSELL HOMECARE, INC. IS NOT LIABLE FOR INCIDENTAL OR CONSEQUENTIAL DAMAGES OF ANY NATURE ASSOCIATED WITH THE USE OF THIS PRODUCT. BISSELL'S LIABILITY WILL NOT EXCEED THE PURCHASE PRICE OF THE PRODUCT.

Some states do not allow the exclusion or limitation of incidental or consequential damages, so the above limitation or exclusion may not apply to you.

*EXCEPTIONS AND EXCLUSIONS FROM THE TERMS OF THE LIMITED WARRANTY

THIS WARRANTY IS EXCLUSIVE AND IN LIEU OF ANY OTHER WARRANTIES EITHER ORAL OR WRITTEN. ANY IMPLIED WARRANTIES WHICH MAY ARISE BY OPERATION OF LAW, INCLUDING THE IMPLIED WARRANTIES OF MERCHANTABILITY AND FITNESS FOR A PARTICULAR PURPOSE, ARE LIMITED TO THE ONE YEAR DURATION FROM THE DATE OF PURCHASE AS DESCRIBED ABOVE.

Some states do not allow limitations on how long an implied warranty lasts, so the above limitation may not apply to you.

Microban® is a registered trademark of Microban Products Company

20

www.bissell.com



©2007 BISSELL Homecare, Inc.
Grand Rapids, Michigan
All rights reserved. Printed in China
Part Number 120-4004
Rev 7/07
Visit our website at:
www.bissell.com
Scotchgard is a trademark of 3M

800.237.7691