

This Owner's Manual is provided and hosted by [Appliance Factory Parts](#).



# LG BHD-301-E Owner's Manual

[Shop genuine replacement parts for LG BHD-301-E](#)



[Find Your LG Dehumidifier Parts - Select From 224 Models](#)

----- Manual continues below -----

# HEAT CONTROLLER, INC.

*Comfort-Care*<sup>®</sup>

## Dehumidifier

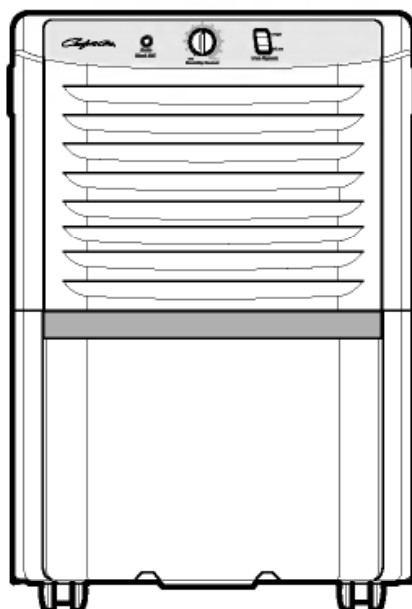

**MODEL: BHD-301-D  
BHD-301-E**

## *Owners Manual*

### ***Important Information***

- Please read carefully and thoroughly this manual before operating this unit.
- Contact a qualified service technician for installation, repair and maintenance of this unit.
- The appliance is not intended for use by young children or those who require supervision.
- Young children should be supervised to ensure that they do not play with the appliance.

# TABLE OF CONTENTS

Safety Precautions .....	3
Prior to Operation .....	7
Instruction .....	8
Electrical Safety .....	9
Operating Instructions .....	11
Installation .....	13
Maintenance .....	14



## FOR YOUR RECORDS

Write the model and serial numbers here:

**Model #** \_\_\_\_\_

**Serial #** \_\_\_\_\_

You can find them on a label on the side of each unit.

**Dealer's Name** \_\_\_\_\_

**Date Purchased** \_\_\_\_\_

■ Staple your receipt to this page in the event you need it to prove date of purchase or for warranty issues.



## READ THIS MANUAL

Inside you will find many helpful hints on how to use and maintain your dehumidifier properly. Just a little preventive care on your part can save you a great deal of time and money over the life of your dehumidifier.

You'll find many answers to common problems in the chart of troubleshooting tips. If you review our chart of

**Troubleshooting Tips** first, you may not need to call for service at all.



## PRECAUTION



- Contact the authorized service technician for repair or maintenance of this unit.
- Contact the installer for installation of this unit.
- The dehumidifier is not intended for use by young children without adult supervision.
- Young children should be supervised to ensure that they do not play with the dehumidifier.
- When the power cord is to be replaced, replacement work shall be performed by authorized personnel only using only genuine replacement parts.





# Safety Precautions

## Read all instruction before using

- To prevent injury to the user or other people and property damage, the following instructions must be followed.
- Incorrect operation due to ignoring instructions will cause harm or damage; the seriousness is classified by the following indications.

	<b>WARNING</b> This symbol indicates the possibility of death or serious injury.
	<b>CAUTION</b> This symbol indicates the possibility of injury or damage to property only.

- Meanings of symbols used in this manual are as shown below.

	<b>Be sure not to do.</b>
	<b>Be sure to follow the instruction.</b>

## WARNING

### ■ Installation

Do not place the power cord near a heater.

- It may cause fire and electric shock.

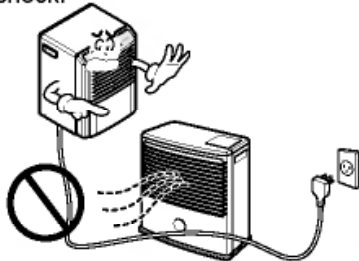

Do not use the power cord near flammable or combustibles materials such as gasoline, benzene, paint thinner, etc.

- It may cause explosion or fire.



Do not disassemble or modify products.

- It may cause electric shock and failure.



### ■ Operation

Plug in the power plug properly.

- Otherwise, it will cause electric shock or fire.

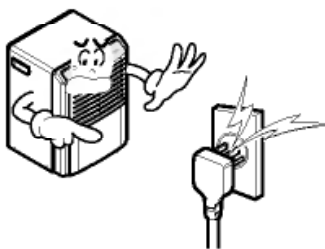

Do not operate or stop the unit by inserting or pulling out the power plug.

- It will cause electric shock or fire.

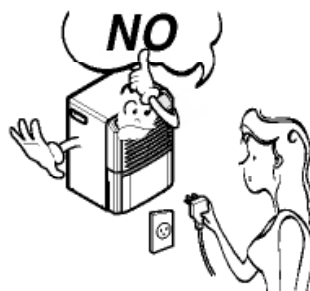

Do not damage or use an unspecified power cord.

- It will cause electric shock or fire.

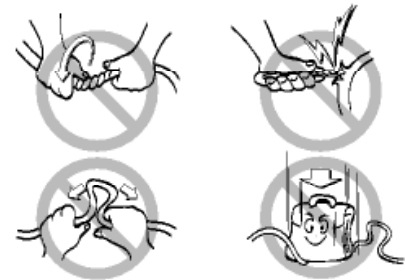

## Safety Precautions

**Do not modify power cord length.**

- It will cause electric shock or fire.

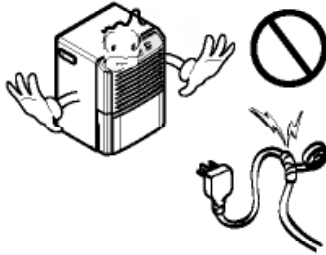

**Do not share the outlet with other appliances.**

- It will cause electric shock or fire.

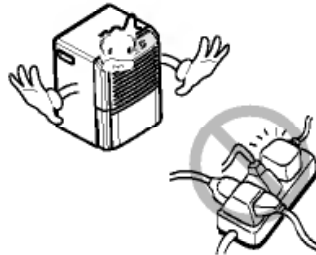

**Always plug into a grounded outlet.**

- No grounding may cause electric shock.

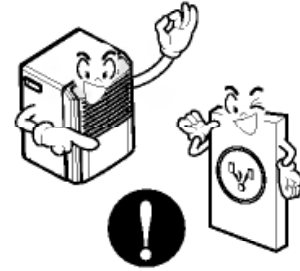

**Unplug the unit if strange sounds, odors, or smoke come from it.**

- Otherwise it may cause a fire or an electric shock.



**Do not use the socket if it is loose or damaged.**

- It may cause fire and electric shock.

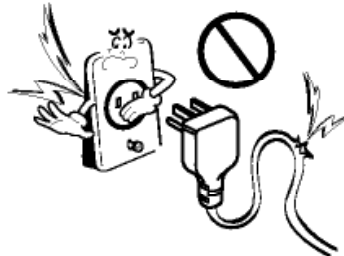

**Do not operate with wet hands.**

- It may cause electric shock.

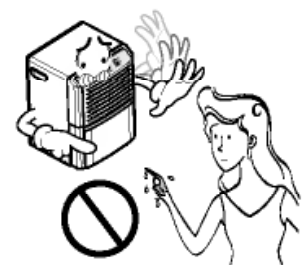

**Do not clean the dehumidifier with water.**

- Water may enter the unit and degrade the insulation. It may cause an electric shock.

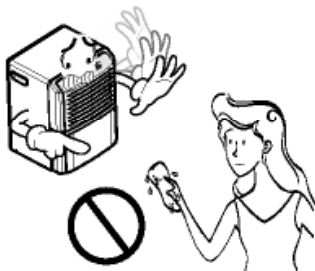

**Turn off the power and breaker first when cleaning the unit.**

- Since the fan rotates at high speed during operation, it may cause injury.



**If water enters the product, turn off the dehumidifier's power switch. Contact service center after taking the power-plug out from the socket.**

- It will cause machine failure or electric shock.

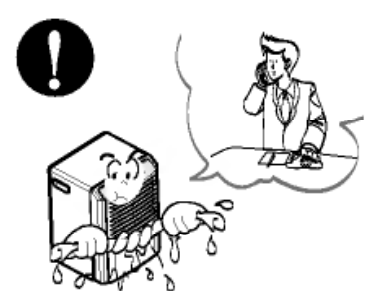

**CAUTION**

ENGLISH

**Installation**

**Never touch the metal parts of the unit when removing the filter.**

- They are sharp and may cause injury.

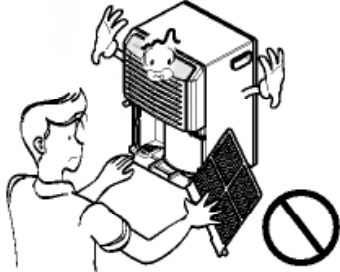

**Do not block the inlet or outlet.**

- It may cause failure of appliance or performance deterioration.

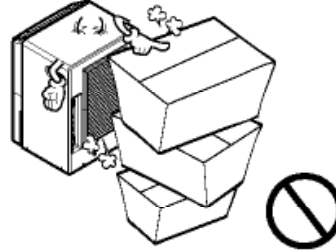

**Hold the plug by the head when taking it out.**

- It may cause electric shock and damage.

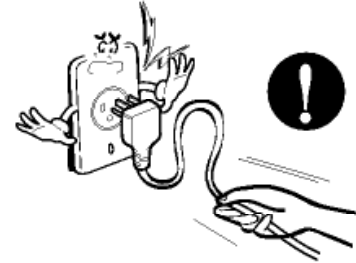

**Secure wheels with blocks to prevent unit from falling when installed on a table or shelf.**

- It may damage the dehumidifier or cause other damage or injury.

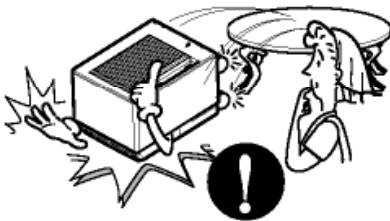

**Make sure the dehumidifier is the correct size for the area you want to dehumidify.**

- It is not designed to dehumidify the entire house.

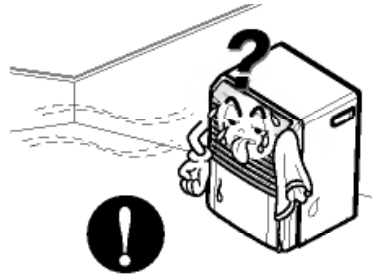

**Install the dehumidifier properly on a floor, table, or shelf that is level and strong enough to support it when the water collection bucket is full.**

- It should withstand around 90 lbs (40kg) of weight.



**Close all doors, windows and other outside openings to the room.**

- The dehumidifier must be operated in an enclosed area to be most effective.



## ■ Operation

Use a soft cloth to clean. Do not use wax, thinner, or a strong detergent.

- The appearance of the dehumidifier may deteriorate, change color, or develop surface flaws.



Be sure to replace the bucket properly after emptying to prevent water from collecting on the floor.

- Otherwise, it will cause property damage.

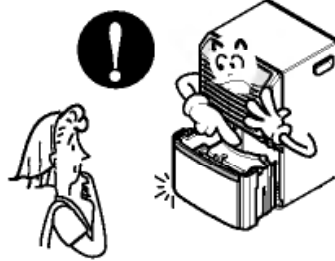

Do not operate if the room temperature is below 65°F (18°C).

- At operating temperatures lower than 65°F (18°C) the performance of the unit drops significantly.



Do not put a pet or house plant where it will be exposed to direct air flow.

- This could injure the pet or plant.



Do not use this appliance for preserving precision devices, foods, pets, plants, and art objects.

- It is a general use appliance not precision equipment.

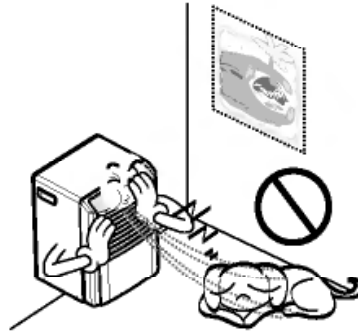

Do not use the water collected in the bucket for drinking purposes.

- It is not sanitary and could cause illness or personal injury.

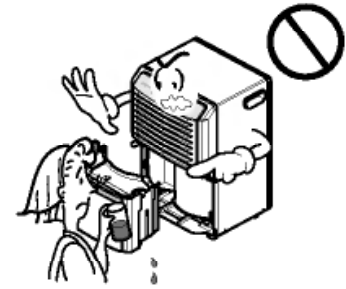

Always insert the filter securely. Clean it every two weeks.

- Operation without filters will cause failure.

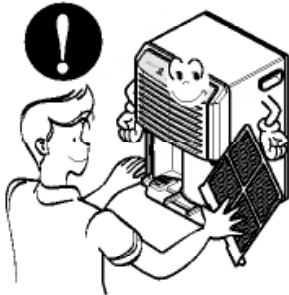

# Prior to Operation

## Preparing for operation

1. Consult an installation specialist for installation.
2. Plug in the power plug properly.
3. Use a dedicated circuit.
4. Do not use an extension cord.
5. Do not start/stop operation by plugging/unplugging the power cord.
6. If the cord/plug is damaged, only replace it with an authorized replacement part.

## Usage

1. Being exposed to direct airflow for an extended period of time could be hazardous to your health. Do not expose occupants, pets, or plants to direct airflow for extended periods of time.
2. Do not use this dehumidifier for non-specified special purposes (e.g. preserving precision devices, food, pets, plants, and art objects). Such usage could damage the items.

## Cleaning and maintenance

1. Do not touch the metal parts of the unit when removing the filter. Injuries can occur when handling sharp metal edges.
2. Do not use water to clean inside the dehumidifier. Exposure to water can destroy the insulation, leading to possible electric shock.
3. When cleaning the unit, first make sure that the power and breaker are turned off. The fan rotates at a very high speed during operation. There is a possibility of injury if the unit's power is accidentally turned on while the interior of the unit is being cleaned.



# Instruction

## Symbols used in this Manual



This symbol alerts you to the risk of electric shock.



This symbol alerts you to hazards that could cause harm to the dehumidifier.

**NOTICE**

This symbol indicates special notes.

## Features



**WARNING:** This appliance should be installed in accordance with national wiring regulations. This guide acts as a guide to help to explain product features.

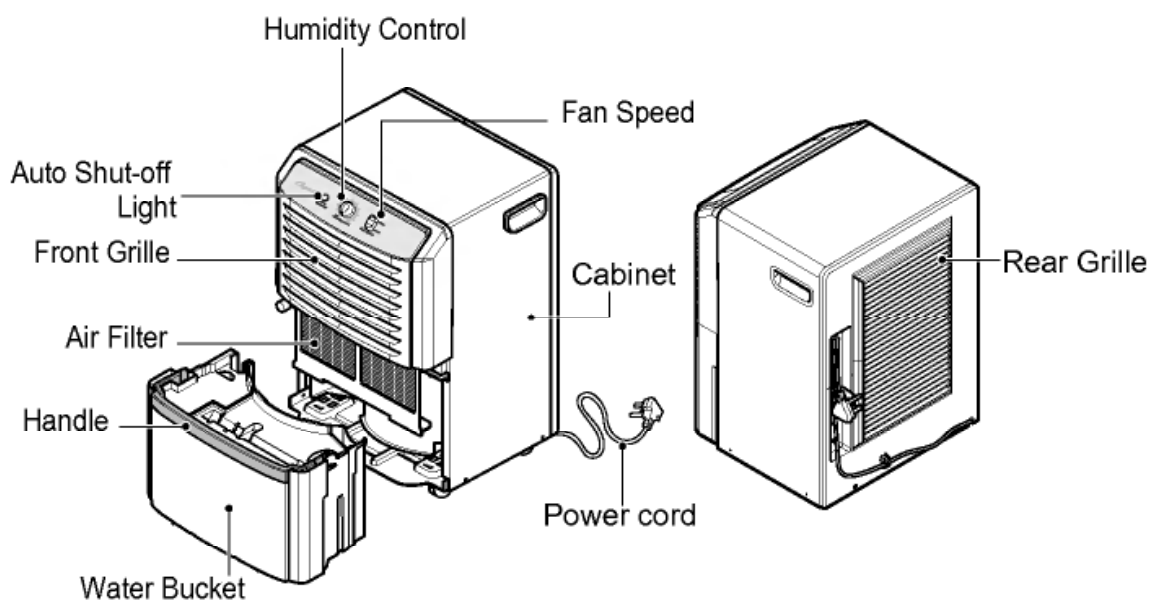

# Electrical Safety



**WARNING: This appliance must be properly grounded.**

The power cord of this appliance is equipped with a three-prong grounding plug. To minimize the risk of electric shock, use the plug with a standard three-slot grounding wall power outlet. If the power outlet does not include a grounding slot, have a qualified electrician replace the outlet before you use the dehumidifier.

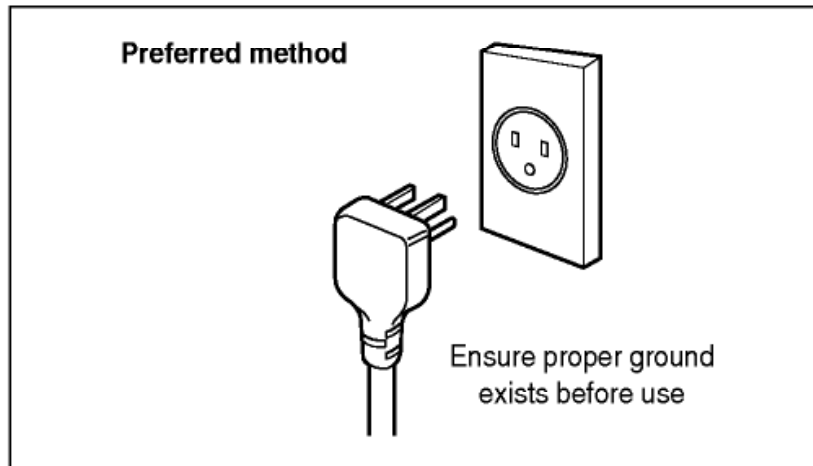

**WARNING: Do not cut or remove the grounding prong from the power plug.**



**WARNING: Attaching the adapter ground terminal to the wall receptacle cover screw does not ground the appliance unless the cover screw is metal and not insulated, and the wall receptacle is grounded through the house wiring.**



**WARNING: If you have any doubt whether the dehumidifier is properly grounded, have the wall receptacle and circuit checked by a qualified electrician.**

## Temporary Use of an Adapter

We **strongly discourage** the use of an adapter due to potential safety hazards. For temporary connections, use only a UL-listed adapter, available from most local hardware stores. To disconnect the power cord from the adapter, use one hand on each to avoid damaging the ground terminal. Avoid frequently unplugging the power cord as this can lead to eventual ground terminal damage.

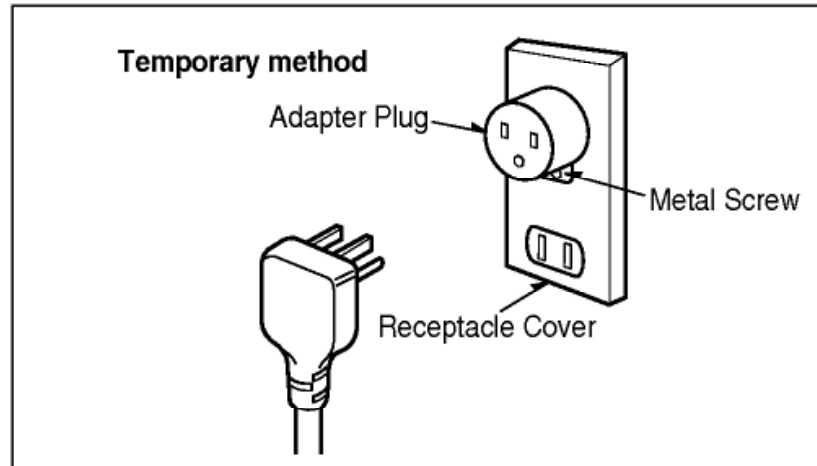

**WARNING:** Never use the appliance with a broken adapter.

## Temporary Use of an Extension Cord

We **strongly discourage** the use of an extension cord due to potential safety hazards.

# Operating Instructions



## CONTROL

Your dehumidifier has a control panel containing an indicator and two controls —

Auto Shut-Off, Fan Speed, and Humidity Control.

Auto Shut-Off ---The light turns on when the bucket is full or missing.

Fan Speed --- This controls the speed of the airflow.

Humidity Control--- This controls the moisture in the room.

## UNIT OPERATION

1. Turn the Humidity Control to **Off**. Plug the power supply cord into an electrical outlet.
2. The Humidity Control can be set anywhere between **Off** and **Max** for normal operation. If you need more dehumidification, turn the Humidity Control toward **Max**. If you need less dehumidification, turn the Humidity Control toward **Off**.
3. Turn the Humidity Control to **Off** to stop the unit manually.
4. If you want to control the speed of air flow, turn the Fan Speed toward **Low** or **High**.

**NOTICE** The compressor will not operate for about three minutes to protect the compressor when you turn the unit off and immediately back on.

## Automatic Defrost Control

The Defrost Control senses frost build-up on the evaporator coil and automatically shuts off the compressor. The fan continues to run, drawing air across the coil, and melting the frost. When the coil is defrosted, the compressor automatically restarts, and dehumidifying resumes.

**NOTICE** Water bucket must be properly installed.

- The dehumidifier will not run if the bucket is not properly installed.
- The dehumidifier shuts off when the desired humidity setting is reached.

## Automatic shut off

The dehumidifier will turn off automatically when the bucket is full, or when the bucket is removed or not replaced in the proper position.

**The bucket must be replaced in the proper position for the dehumidifier to work. The light will be on and the dehumidifier will not run if the bucket is not in the proper position.**

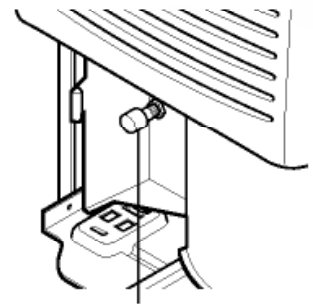

Water level control switch

## Disposing of collected water

### 1. Empty the bucket manually.

When the bucket is full, pull out by grasping the handle and empty it into a large sink or tub and then replace it properly.

**NOTICE** Do not remove while operating the dehumidifier. It can cause water to drop on the base pan or the floor. Empty the bucket when the indicator light turns on.

**NOTICE** It is advisable to carry the bucket by supporting it from the bottom as well as by the handle. Carrying by only the handle may cause the handle or bucket cover to break.

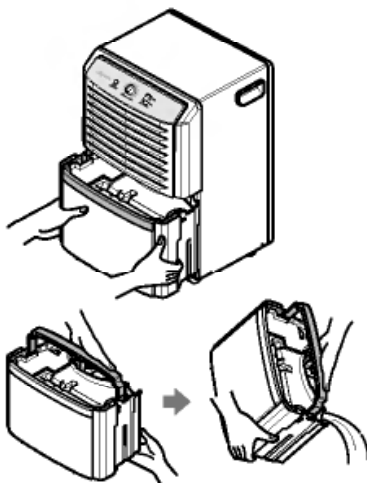

### 2. Attach a length of garden hose to the threaded drain hose connection to carry water to the drain.

1. Connect a garden hose to the threaded drain hose connector. (Fig1)

2. Remove the drain-hole cover. (Fig2)

3. Push hose connector tightly into the drain-hole on Rear Grille. (Fig3-1,3-2)

4. Press the hose down and make sure the "Arrow" is pointing upward. (Fig4-1,4-2)

5. The connection should be resemble Fig5 when complete.

**NOTICE** The hose attachment will accept a standard garden hose fitting.

**Do not over tighten the hose when connecting it to the hose connector, use a rubber washer and tighten by hand firmly without stripping the plastic threads.**

When being attached to hose connector drain hose connection, do not bend or kink the hose. The hose should lie flat from the dehumidifier to the drain.

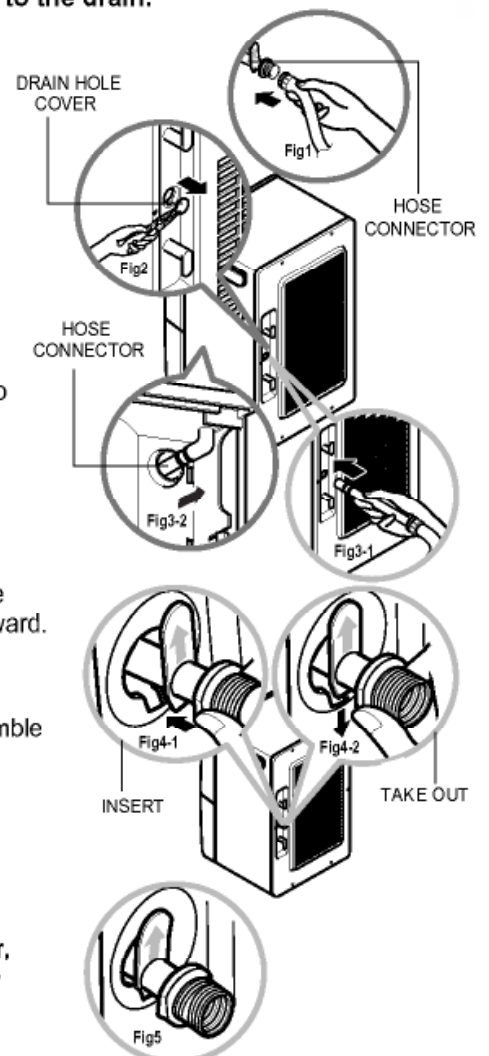

# Installation

## Choosing the proper location for your dehumidifier

- Use the dehumidifier in a basement to help prevent moisture damage.

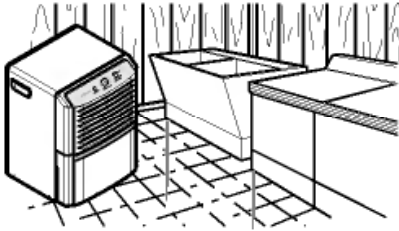

- Use the dehumidifier in laundry drying, bathing, and dishwashing areas which have excessive moisture.

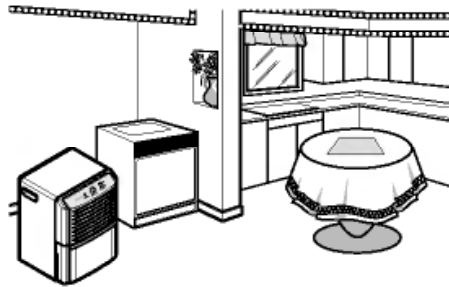

- Use the dehumidifier to prevent moisture damage where books are stored.

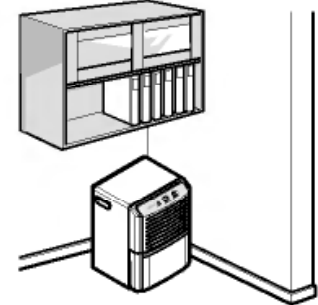

ENGLISH

## Installing the dehumidifier properly

1. Allow at least 12 inches of space on all sides of the unit for good air circulation.
2. Install your dehumidifier on a floor, table, or shelf. When installing the dehumidifier on a table or shelf, make sure the table or shelf is strong enough to support the weight of the dehumidifier with a full bucket. Do not sit or stand on the dehumidifier. Secure wheels with blocks to prevent unit from falling when installed on a table or shelf.

**NOTICE** The height of a table or shelf might provide a better position from which to handle the bucket and help prevent icing of the coils due to colder air near the floor (such as in a basement.)

3. Lift the bucket and place it in the dehumidifier, making sure the slots on the bottom side of the bucket are positioned correctly.
4. Rollers let you move the dehumidifier easily.

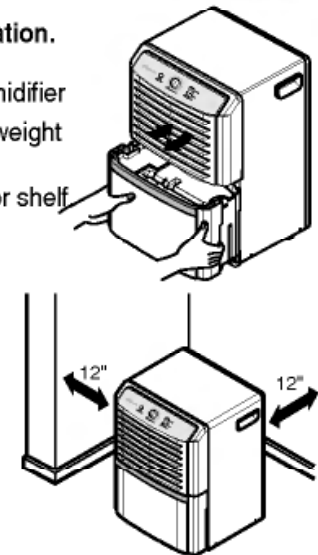

## The cleaning of bucket

1. Pull out the bucket cover.
2. Brush off the residue in the bucket.
3. Close the cover.

**NOTICE** Clean the bucket by wiping with a cloth dampened in a mild detergent solution.

**NOTICE** Push the tabs on the top of the bucket when installing the bucket.

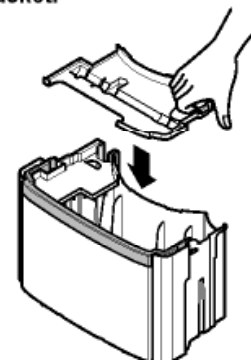
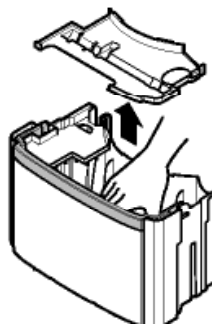
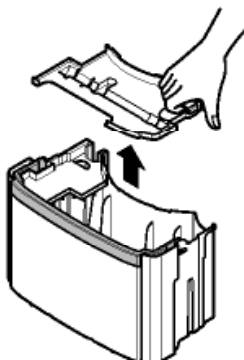

## Maintenance

Your dehumidifier is designed to serve you year-round. It needs practically no attention. However, you should check your dehumidifier annually.

You may want an Authorized Service Center to perform this annual checkup. (Cost of the inspection is the owner's responsibility.)

### **⚠ WARNING**

#### **Electrical Shock Hazard**

- Disconnect power supply cord from receptacle before performing any maintenance.
- Be careful when cleaning the coils. Fins are sharp.

Failure to follow the above precautions could result in electrical shock or personal injury.

### **Cleaning the front case, bucket and cabinet**

Clean the front case and the cabinet with a soft cloth, warm water, and a mild detergent. Clean the grille with a vacuum attachment or brush. Do not use bleach or abrasives.

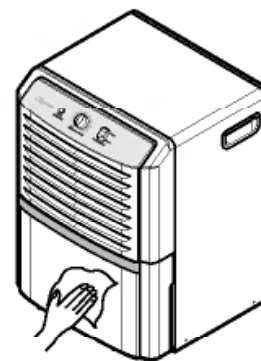

### **Cleaning the air filter**

- 1.** Remove water bucket from the cabinet. Pull out the air filter as shown above.
- 2.** Wash air filter with warm water and a mild detergent. Rinse and dry it. **Replace it in place.**

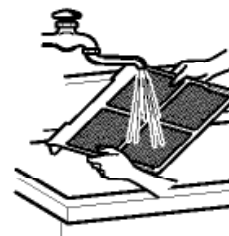
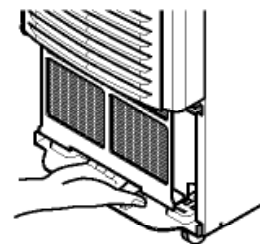

## Troubleshooting

### SERVICE

To save time and expense, check the following before calling for an authorized service center.



The dehumidifier may be operating abnormally when:

Problem	Possible Causes	What To Do
Dehumidifier does not operate	<ul style="list-style-type: none"> <li>■ Plug is disconnected from outlet.</li> </ul>	<ul style="list-style-type: none"> <li>• Push plug firmly into wall outlet.</li> </ul>
	<ul style="list-style-type: none"> <li>■ The fuse is blown/circuit breaker is tripped.</li> </ul>	<ul style="list-style-type: none"> <li>• Check the house fuse/circuit breaker box and replace fuse or reset the breaker.</li> </ul>
	<ul style="list-style-type: none"> <li>■ The dryness level you selected has been reached.</li> </ul>	<ul style="list-style-type: none"> <li>• Dehumidifier automatically shuts off when the selected amount of moisture has been removed from the air. If you want to remove more moisture, turn the humidity Control to <b>Max</b>. After the dehumidifier starts, reset the control to the desired setting.</li> </ul>
	<ul style="list-style-type: none"> <li>■ The <b>Auto Shut-Off</b> light is on.</li> </ul>	<ul style="list-style-type: none"> <li>• Dehumidifier automatically shuts off when the bucket is full. Empty the bucket and replace it.</li> </ul>
	<ul style="list-style-type: none"> <li>■ Dehumidifier is not turned on.</li> </ul>	<ul style="list-style-type: none"> <li>• Turn on the Humidity Control.</li> </ul>
Dehumidifier runs too much	<ul style="list-style-type: none"> <li>■ Humidity Control is set too high.</li> </ul>	<ul style="list-style-type: none"> <li>• Turn the Humidity Control to a lower setting.</li> </ul>
	<ul style="list-style-type: none"> <li>■ Windows or doors near dehumidifier are open to outdoors.</li> </ul>	<ul style="list-style-type: none"> <li>• Close all windows or doors to outside.</li> </ul>
	<ul style="list-style-type: none"> <li>■ Area to be dehumidified is too large.</li> <li>■ Air movement through dehumidifier is blocked.</li> </ul>	<ul style="list-style-type: none"> <li>• Check with your dealer to see if capacity is adequate.</li> <li>• Front grille may be dirty. Use a brush to clean the grille. Dehumidifier's coils on the back of unit may be dirty. Clean the soil on the coils of the back of the unit. Dehumidifier must be placed in a space that does not restrict air flowing into the rear coil or out of the front grille.</li> </ul>
	<ul style="list-style-type: none"> <li>■ Humidity Control is set at <b>Max</b>.</li> </ul>	<ul style="list-style-type: none"> <li>• Dehumidifier will not turn off if Humidity Control is at <b>Max</b>.</li> </ul>
Frost appears on coils	<ul style="list-style-type: none"> <li>■ Room temperature is too low. (Room temperature is below 65°F (18°C).)</li> </ul>	<ul style="list-style-type: none"> <li>• Frost will usually disappear within 60 minutes.</li> </ul>
Fan noise	<ul style="list-style-type: none"> <li>■ Air is moving through the dehumidifier.</li> </ul>	<ul style="list-style-type: none"> <li>• This is a normal sound.</li> </ul>



Problem	Possible Causes	What To Do
Dehumidifier does not dry the air as it should	<ul style="list-style-type: none"> <li>■ Dehumidifier has been installed or restarted recently.</li> </ul>	<ul style="list-style-type: none"> <li>• The more moisture in the room air, the longer it takes for the room air to become dry.</li> </ul>
	<ul style="list-style-type: none"> <li>■ Airflow is restricted.</li> </ul>	<ul style="list-style-type: none"> <li>• Make sure there are no curtains, blinds, or furniture blocking the front or back of the dehumidifier.</li> </ul>
	<ul style="list-style-type: none"> <li>■ The control may not be set high enough.</li> </ul>	<ul style="list-style-type: none"> <li>• Turn the knob to a higher number.</li> </ul>
	<ul style="list-style-type: none"> <li>■ Doors and windows may not be closed tightly.</li> </ul>	<ul style="list-style-type: none"> <li>• Check that all doors, windows, and other openings are securely close.</li> </ul>
	<ul style="list-style-type: none"> <li>■ Household equipment such as clothes dryers or dishwashers may be blowing moist air into the room.</li> </ul>	<ul style="list-style-type: none"> <li>• Place the dehumidifier away from household appliance air vents. Ensure that clothes dryers are vented outside.</li> </ul>
	<ul style="list-style-type: none"> <li>■ Room temperature is too low.</li> </ul>	<ul style="list-style-type: none"> <li>• The unit will not operate satisfactorily if the room temperature is below 65°F (18°C.)</li> </ul>

---

## Service

For repair and maintenance, contact your authorized service dealer.

**For models installed in North America,** please review the troubleshooting recommendations above.

If you have read the Installation and Operation booklet completely and feel you need service, please call

**1-877-755-7932**

or you may write:

Heat Controller Inc.

1900 Wellworth Ave. Jackson, MI 49203

### **Proof of Purchase Date**

It is the responsibility of the consumer to establish the original purchase date for warranty purposes. We recommend a bill of sale, cancelled check or some other appropriate payment record be kept for that purpose.

**For models installed outside of North America,** the manufacturer does not extend any implied or expressed warranty. Please consult your dealer for any warranty terms extended by the importer in your country.

If you have additional questions you may call 1-517- 787-2100

Or E-Mail [customerservice@heatcontroller.com](mailto:customerservice@heatcontroller.com) or [techservice@heatcontroller.com](mailto:techservice@heatcontroller.com)

Call (517) 787-2100 for obtaining service parts beyond your warranty period.

# Notes