

This Owner's Manual is provided and hosted by [Appliance Factory Parts](#).



FRIEDRICH PDH15R5SF Owner's Manual

[Shop genuine replacement parts for FRIEDRICH
PDH15R5SF](#)



[Find Your FRIEDRICH Air Conditioner Parts - Select From 1575 Models](#)

----- Manual continues below -----



F R I E D R I C H
2 0 1 1



PTAC - R410A Models

Packaged Terminal Air Conditioners

Packaged Terminal Heat Pumps

CUSTOMER SATISFACTION and QUALITY ASSURANCE

Friedrich is a conscientious manufacturer, concerned about customer satisfaction, product quality, and controlling warranty costs. As an Authorized Service Provider you play a vital role in these areas. By adhering to the policies and procedures you provide us with vital information on each warranty repair you complete. This information is used to identify product failure trends, initiate corrective action, and improve product quality, thereby further reducing warranty expenses while increasing customer satisfaction levels.

CHARGES TO CUSTOMER

The customer/end user is not to be charged for any warranty repairs to correct defects in materials or workmanship in accordance with the specific warranty provisions outlined in the product's warranty certificate.

FRIEDRICH AUTHORIZED PARTS DEPOTS

AAA Refrigeration Service

1322 24th Street, Suite B
Kenner, Louisiana 70062
504-464-7444
877-813-7444

The Gabbert Company

6868 Ardmore
Houston, Texas 77054
713-747-4110
800-458-4110

Reeve Air Conditioning, Inc.

2501 South Park Road
Hallandale, Florida 33009
954-962-0252
800-962-3383

Alamo Service Company

1450 North Flores Street
San Antonio, Texas 78212
210-227-2450
800-328-2450

Johnstone Supply of Woodside

27-01 Brooklyn Queens Expway
Woodside, New York 11377
718-545-5464
800-431-1143

TECHNICAL SUPPORT CONTACT INFORMATION



F R I E D R I C H

FRIEDRICH AIR CONDITIONING CO.

10001 Reunion Place, Ste. 500, San Antonio, TX 78216
(210) 546-0500 877-599-5665 x 261 FAX (210) 546-0630
Email: tac@friedrich.com
www.friedrich.com

Printed in the U.S.A.

Table of Contents

Important Safety Information	2-4	Capillary Tube Systems/Check Valve	33
Introduction	4	Reversing Valve — Description/Operation	34
General Product Features	5	Testing Coil	34
HVAC Engineering Specifications	6	Checking Reversing Valves	34-35
Component identification	7	Reversing Valve	
Accessories	8-9	Touch Testing Heating/Cooling Cycle	35
Unit Identification	10	Procedure For Changing Reversing Valve	35-36
Chassis Specifications	11	Compressor Checks	36
Cooling and Heating Performance	12-13	Locked Rotor Voltage Test	36
Electric Heat Data	14	Single Phase Connections	36
Electrical Rating Tables	15	Determine Locked Rotor Voltage	36
Power Cord Information	15-17	Locked Rotor Amperage Test	36
Remote Wall Thermostat / Low Voltage		Single Phase Running & Locked Rotor Amperage	36
Wire Connections	18-19	Checking the Overload	36
Digital Control Features	20	External Overload	37
Digital Control Operation	21	Compressor Single Phase Resistance Test	37
Digital Control User Input Configuration	22	Compressor Replacement	38-39
Digital Control Diagnostics	23	Routine Maintenance	39
Malfunction Analysis	24-26	Troubleshooting Charts	40-41
Components Testing	27-28	Wiring Diagrams for Wall Mounted Thermostats	42-43
Refrigeration System Sequence of Operation	29	Wiring Diagram	42-44
Sealed Refrigeration System Repairs	30	RT6 Installation, Operation and Application Guide	45-46
Refrigerant Charging	31	Thermistors Resistance Values	47-48
Method Of Charging	31	Warranty	49
Undercharged Refrigerant Systems	31-32	2011 PTAC Exploded View	50
Overcharged Refrigerant Systems	32	2011 PTAC Parts List - PDE Models	51
Restricted Refrigerant Systems	32	2011 PTAC Parts List - PDH Models	52

IMPORTANT SAFETY INFORMATION

The information contained in this manual is intended for use by a qualified service technician who is familiar with the safety procedures required for installation and repair, and who is equipped with the proper tools and test instruments required to service this product.

Installation or repairs made by unqualified persons can result in subjecting the unqualified person making such repairs as well as the persons being served by the equipment to hazards resulting in injury or electrical shock which can be serious or even fatal.

Safety warnings have been placed throughout this manual to alert you to potential hazards that may be encountered. If you install or perform service on equipment, it is your responsibility to read and obey these warnings to guard against any bodily injury or property damage which may result to you or others.

Your safety and the safety of others are very important.

We have provided many important safety messages in this manual and on your appliance. Always read and obey all safety messages.



This is a safety Alert symbol.

This symbol alerts you to potential hazards that can kill or hurt you and others.

All safety messages will follow the safety alert symbol with the word "WARNING" or "CAUTION". These words mean:



You can be killed or seriously injured if you do not follow instructions.



You can receive minor or moderate injury if you do not follow instructions.

All safety messages will tell you what the potential hazard is, tell you how to reduce the chance of injury, and tell you what will happen if the instructions are not followed.



A message to alert you of potential property damage will have the word "NOTICE". Potential property damage can occur if instructions are not followed.

PERSONAL INJURY OR DEATH HAZARDS

ELECTRICAL HAZARDS:

- Unplug and/or disconnect all electrical power to the unit before performing inspections, maintenance, or service.
- Make sure to follow proper lockout/tag out procedures.
- Always work in the company of a qualified assistant if possible.
- Capacitors, even when disconnected from the electrical power source, retain an electrical charge potential capable of causing electric shock or electrocution.
- Handle, discharge, and test capacitors according to safe, established, standards, and approved procedures.
- Extreme care, proper judgment, and safety procedures must be exercised if it becomes necessary to test or troubleshoot equipment with the power on to the unit.
- Do not spray or pour water on the return air grille, discharge air grille, evaporator coil, control panel, and sleeve on the room side of the air conditioning unit while cleaning.
- Electrical component malfunction caused by water could result in electric shock or other electrically unsafe conditions when the power is restored and the unit is turned on, even after the exterior is dry.
- Never operate the A/C unit with wet hands.
- Use air conditioner on a single dedicated circuit within the specified amperage rating.
- Use on a properly grounded outlet only.
- Do not remove ground prong of plug.
- Do not cut or modify the power supply cord.
- Do not use extension cords with the unit.
- Follow all safety precautions and use proper and adequate protective safety aids such as: gloves, goggles, clothing, adequately insulated tools, and testing equipment etc.
- Failure to follow proper safety procedures and/or these warnings can result in serious injury or death.

REFRIGERATION SYSTEM HAZARDS:

- Use approved standard refrigerant recovering procedures and equipment to relieve pressure before opening system for repair.
- Do not allow liquid refrigerant to contact skin. Direct contact with liquid refrigerant can result in minor to moderate injury.
- Be extremely careful when using an oxy-acetylene torch. Direct contact with the torch's flame or hot surfaces can cause serious burns.
- Make sure to protect personal and surrounding property with fire proof materials.
- Have a fire extinguisher at hand while using a torch.
- Provide adequate ventilation to vent off toxic fumes, and work with a qualified assistant whenever possible.
- Always use a pressure regulator when using dry nitrogen to test the sealed refrigeration system for leaks, flushing etc.

- Make sure to follow all safety precautions and to use proper protective safety aids such as: gloves, safety glasses, clothing etc.
- Failure to follow proper safety procedures and/or these warnings can result in serious injury or death.

MECHANICAL HAZARDS:

- Extreme care, proper judgment and all safety procedures must be followed when testing, troubleshooting, handling, or working around unit with moving and/or rotating parts.
- Be careful when, handling and working around exposed edges and corners of sleeve, chassis, and other unit components especially the sharp fins of the indoor and outdoor coils.
- Use proper and adequate protective aids such as: gloves, clothing, safety glasses etc.
- Failure to follow proper safety procedures and/or these warnings can result in serious injury or death.

PROPERTY DAMAGE HAZARDS

FIRE DAMAGE HAZARDS:

- Read the Installation/Operation Manual for this air conditioning unit prior to operating.
- Use air conditioner on a single dedicated circuit within the specified amperage rating.
- Connect to a properly grounded outlet only.
- Do not remove ground prong of plug.
- Do not cut or modify the power supply cord.
- Do not use extension cords with the unit.
- Failure to follow these instructions can result in fire and minor to serious property damage.

WATER DAMAGE HAZARDS:

- Improper installation maintenance, or servicing of the air conditioner unit, or not following the above Safety Warnings can result in water damage to personal items or property.
- Insure that the unit has a sufficient pitch to the outside to allow water to drain from the unit.
- Do not drill holes in the bottom of the drain pan or the underside of the unit.
- Failure to follow these instructions can result in result in damage to the unit and/or minor to serious property damage.

INTRODUCTION

This service manual is designed to be used in conjunction with the installation manuals provided with each unit.

This service manual was written to assist the professional HVAC service technician to quickly and accurately diagnose and repair any malfunctions of this product.

This manual, therefore, will deal with all subjects in a general nature. (i.e. All text will pertain to all models).

IMPORTANT: It will be necessary for you to accurately identify the unit you are servicing, so you can be certain of a proper diagnosis and repair. (See Unit Identification.)

General Product Features

DIAMONBLUE TECHNOLOGY	Diamonblue seacoast protection protects the outdoor coil from harsh environments. Comes standard on all models.
DIGITALDEFROST THERMOSTAT	The new Friedrich PTAC uses a digital thermostat to accurately monitor the outdoor coil conditions to allow the heat pump to run whenever conditions are correct. Running the PTAC in heat pump mode saves energy and reduces operating costs. The digital thermostat allows maximization of heat pump run time.
INSTANT HEAT HEAT PUMP MODE	Heat pump models will automatically run the electric heater to quickly bring the room up to temperature when initially energized, then return to heat pump mode. This ensures that the room is brought up to temperature quickly without the usual delay associated with heat pump units.
EVEN HEAT MONITORING	The digital control monitors indoor conditions to ensure that the room temperature is within five degrees of the setpoint. If necessary, the unit will cycle the electric heat to maintain the temperature. This feature ensures guest comfort by delivering the heating benefits of an electric heater while maintaining the efficiency benefits of a heat pump.
SEPARATE HEAT/COOL FAN CYCLE CONTROL	The owner may choose between fan cycling or fan continuous mode based on property preference. (Note: Even heat monitoring and quiet start/stop fan delay only operate in fan cycle mode) Fan continuous mode is used to keep constant airflow circulation in the room during all times the unit is 'ON'. Fan cycle will conserve energy by only operating the fan while the compressor or electric heater is operating. The ability to set the fan cycling condition independently between heating and cooling mode will increase user comfort by allowing the choice of only constantly circulating air in the summer or winter time. Unlike other PTAC brands that only allow one selection.
EMERGENCY HEAT OVERRIDE	In the event of a compressor failure in heat pump mode, the compressor may be locked out to provide heat through the resistance heater. This feature ensures that even in the unlikely event of a compressor failure, the room temperature can be maintained until the compressor can be serviced.
DESK CONTROL READY	All Friedrich digital PTACs have low voltage terminals ready to connect a desk control energy management system. Controlling the unit from a remote location like the front desk can reduce energy usage and requires no additional accessories on the PTAC unit.
INDOOR COIL FROST SENSOR	The frost sensor protects the compressor from damage in the event that airflow is reduced or low outdoor temperatures cause the indoor coil to freeze. When the indoor coil reaches 30°F, the compressor is disabled and the fan continues to operate based on demand. Once the coil temperature returns to 45°F, the compressor returns to operation.
ULTRA QUIET AIR SYSTEM	The new Friedrich PD series units feature an indoor fan system design that reduces sound levels without lowering airflow or preventing proper air circulation.
HIGH EFFICIENCY	The Friedrich PTAC has been engineered so that all functional systems are optimized so that they work together to deliver the highest possible performance.
DUAL MOTOR	With Friedrich's new dual-motor design the indoor motor can run at slower speeds which reduces sound levels indoors.
ROTARY COMPRESSOR	High efficiency rotary compressors are used on all Friedrich PTACs to maximize durability and efficiency.
STAINLESS STEEL ENDPLATES	Outdoor coil endplates made from stainless steel reduce corrosion on the outdoor coil common with other coil designs.
TOP-MOUNTED ANTIMICROBIAL AIR FILTERS	All Friedrich PTAC return air filters feature an antimicrobial element that has proven to prevent mold and bacterial growth in laboratory testing. PDXFT replacement filter kits feature the same antimicrobial agent. All filters are washable, reusable and easily accessed from the top of the unit without the removal of the front cover.
FILTERED FRESH AIR INTAKE	Friedrich PTAC units are capable of introducing up to 75 CFM of outside air into the conditioned space. The outdoor air passes through a washable mesh screen to prevent debris from entering the airstream.
R-410A REFRIGERANT	Friedrich PTAC units use environmentally-friendly refrigerant.

HVAC Engineering Specifications

Digital Packaged Terminal Air Conditioners & Heat Pumps

Cooling: 7600 – 15,000 Btuh

Heating: 7600 – 14500 Btuh (Heat Pump)
6824 – 17060 Btuh (Electric Heat)

Friedrich Models: PDE – Cooling with or without electric heat
PDH – Heat Pump with electric heat

All units shall be factory assembled, piped, wired and fully charged with R-410A. All units shall be certified in accordance with ARI Standard 310 for air conditioners and ARI standard 380 for heat pumps. Units shall be UL listed and carry a UL label. All units shall be factory run-tested to check operation and be Friedrich or equivalent.

The basic unit shall not exceed 16" high x 42" wide. Overall depth of the unit from the rear of the Friedrich wall sleeve to the front of the decorative front cover shall not exceed 21 ¼". The unit shall be designed so that room intrusion may be as little as 7 ½". Installations in walls deeper than 13 ¼" may be accomplished with the use of a deep wall sleeve (PDXWSEXT). Unit shall draw in ambient air through both sides of an outdoor architectural louver or grille measuring 42" wide x 16" high and shall exhaust air out middle portion of the louver. The architectural louver and wall sleeve shall be designed so that the louver may be installed from the inside of the building.

REFRIGERATION SYSTEM – The refrigeration system shall be hermetically sealed and consist of a rotary compressor that is externally mounted on vibration isolators no smaller than 1 3/8" dia. x 1 ½" high; condenser and evaporator coils constructed of copper tubes and aluminum plate fins; and capillaries as expansion devices. Unit shall have a fan slinger ring to increase efficiency and condensate disposal and have a drain pan capable of retaining 1 ½ gallons of condensate. A tertiary condensate removal system shall also be incorporated for back up and shall overflow through the wall sleeve and to the outside of the building as a safeguard against damage to the interior room.

INDOOR AIR HANDLING SECTION – The indoor air handling section shall consist of a tangential blower wheel direct driven by a totally enclosed motor. The air handling system shall be designed to minimize airflow noise and provide smooth and consistent airflow. The indoor fan must have three fan speeds that may be selected by the user.

The indoor discharge grille shall be designed to maximize airflow throughout the room. The grille shall be reversible to allow a change in the airflow directions. The grille openings shall be sized to prevent personal injury or damage to the unit.

The front cover shall incorporate dual air filters conveniently mounted in the front of the unit. The filters must be accessible without the removal of the front cover. The filters shall be made of anti-microbial material to prevent mold and bacterial growth. The filters shall be washable and reusable by cleaning with water or by vacuuming.

The chassis shall have a built-in damper capable of providing at least 75 CFM of fresh air into the conditioned area. A fine mesh screen shall filter the incoming fresh air. There must be a provision for locking the damper closed to ensure a proper seal.

OUTDOOR AIR HANDLING SECTION – The outdoor air section shall consist of a single injection molded fan shroud that incorporates the outdoor motor mount into a single piece for ease of service and assembly. The outdoor motor shall be totally enclosed, ball-bearing, permanently lubricated and directly drive the outdoor fan/slinger ring.

CONTROLS – Covered controls shall be accessible in a compartment at least 7½" wide with the controls no deeper than 1 ¼" in the opening to facilitate easy operation of the unit.

The unit controls shall feature a soft blue LED readout that can display either room temperature or setpoint temperature. The unit shall receive input from the digital control panel through push buttons labeled: 'Cool', 'Heat', 'High Fan', 'Med Fan', 'Low Fan', ▲, ▼ and 'Power'. When 'Off', the unit may be put directly into cooling or heating mode by pressing the 'Cool' or 'Heat' button.

The unit must have the following energy saving and convenience features built-in:

- Quiet start/stop fan delay
- Fan cycle control for cooling and heating independently
- Room freeze protection
- Random compressor restart
- Electronic temperature limiting

The PTAC must also offer the ability to be controlled by a remote wall-mounted thermostat without additional accessories. Low voltage inputs will include: C (common), R (24V power), Y (cooling), GL (fan low), GH (fan high), W (heat) and O (reversing valve on PDH heat pumps only).

PTAC models shall use a single stage cool / single stage heat thermostat. PTHP models shall use a single stage cool / two-stage heat thermostat. An accessory thermostat must be available from the manufacturer, RT6 or equivalent. The RT6 thermostat will provide temperature setpoint, mode selection from cool, heat and fan modes. The thermostat must also allow the selection of fan speed between high and low speed.

Other controls accessible without removal of the chassis shall include fan cycle switch, fresh air vent control and emergency heat override switch (heat pump only).

ELECTRICAL CONNECTION – All PTAC/PTHP units shall come from the factory with a power cord installed. All 230/208V power cords shall feature a leakage current detection device on the plug head. All units shall feature a 6-pin connector for removal of the power cord. The power cord shall be interchangeable to allow changes to the heater output based on the property/electrical requirements.









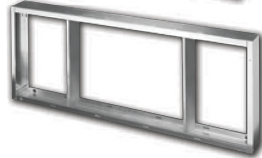

GENERAL CONSTRUCTION – The wall sleeve shall be constructed of 18-gauge Galvanized zinc-coated steel. It shall be prepared by a process where it is zinc phosphate pretreated and sealed with a chromate rinse, then powder coated with a polyester finish and oven cured for durability. The sleeve shall be shipped with a protective weatherboard and a structural center support, and be insulated for sound absorption and thermal efficiency. The grille or louver shall be shipped separately and made from stamped or extruded anodized aluminum. All louvers shall be in the horizontal plane.

The front panel shall attach firmly to the chassis by two hidden spring clips. As an option the cover may be attached by two screws to prevent tampering. The front panel will feature a contoured discharge with no sharp corners.



CORROSION PROTECTION – The unit shall have corrosion-resistant fans, fan shroud and drain pan for corrosion protection and to prevent rust on the side of the building below the outdoor louver. The unit shall feature corrosion resistant materials and finishes to help prevent deterioration. The outdoor coil shall have Diamondblue corrosion protection consisting of hydrophilic coated fins to prolong the life of the coil in all applications including seacoast environments. All outdoor coils shall also have stainless steel endplates to eliminate rusting of the endplates.

WARRANTY – The warranty is one year on all parts and 5 years on the sealed system including compressor, indoor and outdoor coils and refrigerant tubing.

Accessories

New Construction Accessories		
<p>PDXWS</p> <p>PDXWSEXT</p>	<p>WALL SLEEVE Galvanized zinc coated steel is prepared in an 11-step process, then powder coated with a polyester finish and cured in an oven for exceptional durability. The wall sleeve is insulated for sound absorption and thermal efficiency, 16" High x 42" Wide x 13 3/4" Deep.</p> <p>DEEP WALL SLEEVE EXTENSION For use when the wall is thicker than 13 1/4" deep. The wall sleeve may be special ordered through your Sales Representative and will be cut to your specific depth requirements..</p>	<p>PDXWS</p>  <p>PDXWSEXT</p> 
PXGA	GRILLE Standard, stamped aluminium, anodized to resist chalking and oxidation.	<p>PXGA</p>  <p>PXAA</p> 
PXAA PXBG PXSC	ARCHITECTURAL GRILLES Consist of heavy-gauge 6063-T5 aluminium alloy: PXAA – Clear, extruded aluminum PXBG – Beige acrylic enamel PXSC – Also available in custom colors.	
PXDR10	CONDENSATE DRAIN KIT Attaches to the bottom of the wall sleeve for internal draining of condensate or to the rear wall sleeve flange for external draining. Recommended on all units to remove excess condensate. Packaged in quantities of ten.	
PXSB	DECORATIVE SUBBASE Provides unit support for walls less than six inches thick. Includes leveling legs, side filler panels and mounting brackets for electrical accessories. Accepts circuit breaker, power disconnect switch, or conduit kit.	
RT6	DIGITAL REMOTE WALL THERMOSTAT Single stage cool, single stage heat for PDE models or single stage cool, dual stage heat for PDH model thermostat features high/low fan speed switch. Thermostat is hard wired and can be battery powered or unit powered. Features backlit display and multiple configuration modes. For use on PD-series Friedrich PTACs and Vert-I-Paks.	
PDXRTA	REMOTE THERMOSTAT ESCUTCHEON KIT This kit contains ten escutcheons that can be placed over the factory control buttons when a remote wall mounted thermostat is used. The escutcheon directs the guest to the wall thermostat for operation and retains the LED window to display error codes and diagnostic information.	
PXSE	SLEEVE EXTENSION RETROFIT KIT Galvanized zinc coated steel, 2.4" sleeve extension attached to the room side of the sleeve to allow for the installation of a PD-Series Friedrich PTAC in a T-Series sleeve.	
PDXDAA	LATERAL DUCT ADAPTER Attaches to the PTAC/PTHP unit and provides a transition to direct up to 35% of the total CFM to a secondary room, either left or right of the unit. Kit includes duct plenum with discharge grille and internal baffle, adapter and end cap.	
PDXDEA	LATERAL DUCT EXTENSION A three-foot insulated plenum that attaches to the left or right side of the duct adapter. The extension can be cut to length by the installer. Maximum allowable straight extension is 15 feet.	

Accessories

New Construction Accessories		
PXCJA	CONDUIT KIT WITH JUNCTION BOX Hard wire conduit kit with junction box for 208/230V and 265V units (subbase not required). Kit includes a means of quick disconnect for easy removal of the chassis. *Required for 265V installations.	
PXFTA	REPLACEMENT FILTER PACK These are original equipment return air filters. They are reusable and can be cleaned by vacuuming, washing, or blowing out, and are sold in convenient ten-packs. (Two filters per chassis).	

UNIT IDENTIFICATION

Model Number Code

PD H 07 K 3 S F A

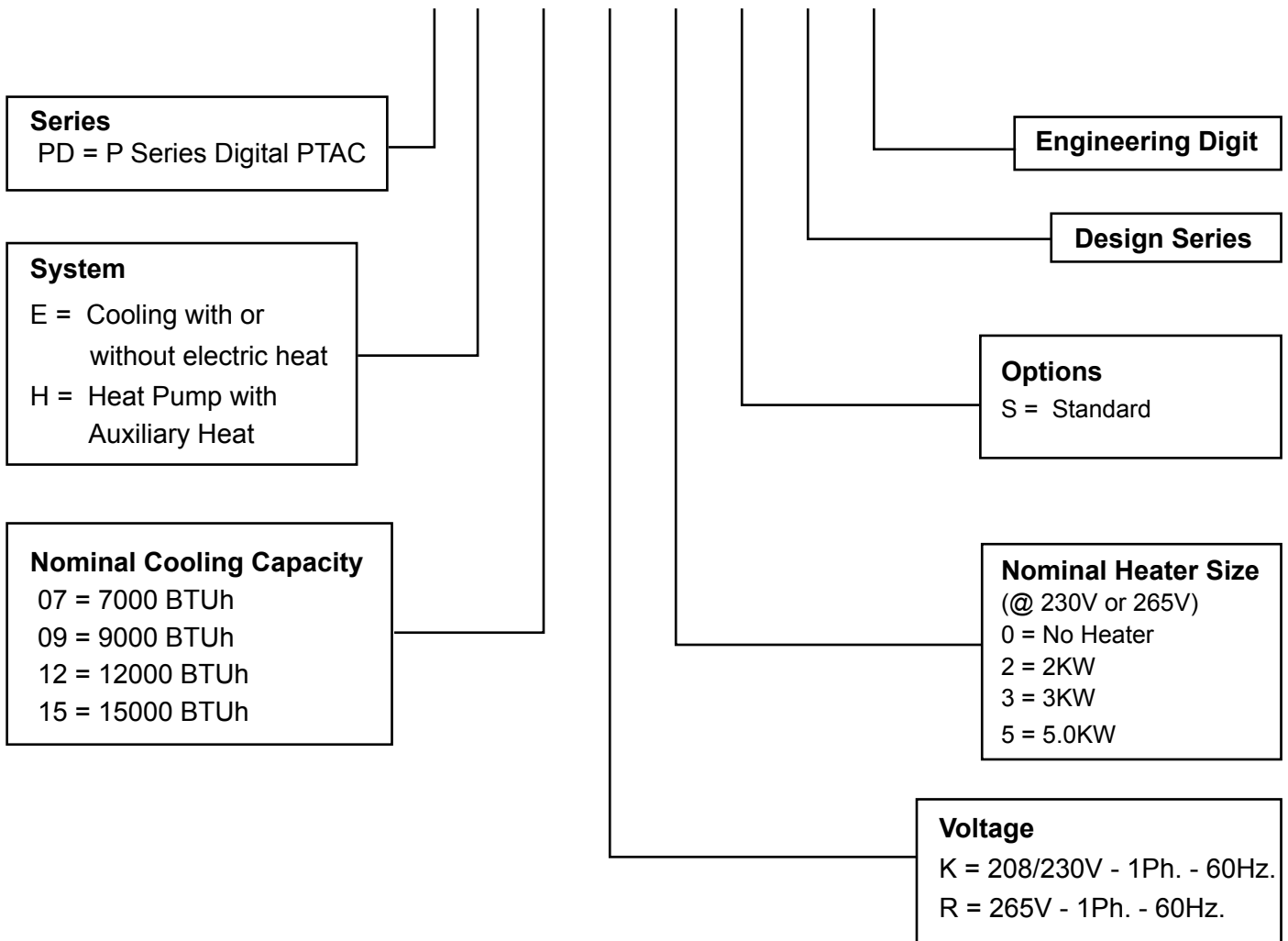

PTAC Serial Number Identification Guide

SERIAL NUMBER	A	A	A	M	00001
YEAR MANUFACTURED					PRODUCTION RUN NUMBER
LJ = 2009 AE = 2015 AK = 2010 AF = 2016 AA = 2011 AG = 2017 AB = 2012 AH = 2018 AC = 2013 AJ = 2019 AD = 2014					PRODUCT LINE M = PTAC
MONTH MANUFACTURED					
A = Jan D = Apr G = Jul K = Oct B = Feb E = May H = Aug L = Nov C = Mar F = Jun J = Sep M = Dec					

Chassis Specifications



PDE Series

	PDE07K	PDE07R	PDE09K	PDE09R	PDE12K	PDE12R	PDE15K	PDE15R
PERFORMANCE DATA:								
COOLING BTUh	7700/7600	7700	9000/8800	9000	12000/11800	12000	15000/14600	15000
POWER (WATTS)	640/620	640	800/770	800	1120/1120	1120	1530/1510	1530
EER	12.0/12.2	12.0	11.3/11.4	11.3	10.7/10.5	10.7	9.8/9.7	9.8
DEHUMIDIFICATION (pints/hr)	1.7	1.7	2.2	2.2	2.7	2.7	3.2	3.2
SENSIBLE HEAT RATIO	0.84	0.84	0.81	0.81	0.67	0.67	0.65	0.65
ELECTRICAL DATA:								
VOLTAGE (1 PHASE, 60 Hz)	230/208	265	230/208	265	230/208	265	230/208	265
VOLT RANGE	253-187	292-239	253-187	292-239	253-187	292-239	253-187	292-239
CURRENT (AMPS)	2.8/3.0	2.4	3.7/3.9	3.7	5.1/5.3	4.8	6.7/7.5	5.9
POWER FACTOR	0.97	0.99	0.99	0.99	0.99	0.99	0.99	0.99
Compressor LRA	19.0	12.0	17.0	18.0	27.00	23.0	32.6	27.8
Compressor RLA	2.8	2.4	3.7	2.9	5.0	4.3	6.6	5.6
Fan motor horsepower	0.024	0.024	0.029	0.029	0.031	0.031	0.031	0.031
AIRFLOW DATA:								
INDOOR CFM, HIGH	345/315	345	360/345	360	360/350	360	385/375	385
INDOOR CFM, MED	320/290	320	330/305	330	330/310	330	360/330	360
INDOOR CFM, LOW	295/265	295	300/270	300	310/280	310	320/290	320
VENT CFM	75	75	75	75	75	75	75	75
PHYSICAL DATA:								
DIMENSIONS	16x42x13 3/4	16x42x13 3/4	16x42x13 3/4	16x42x13 3/4	16x42x13 3/4	16x42x13 3/4	16x42x13 3/4	16x42x13 3/4
NET WEIGHT	106	106	111	111	116	116	119	119
SHIPPING WEIGHT	126	126	131	131	136	136	139	139
R-410A CHARGE (oz)	23.63	24.69	33.51	33.51	35.27	35.98	38.1	40.21
Dim.s w/ Pkg.	19.75x23x 43.5 (all models)							

PDH Series

	PDH07K	PDH07R	PDH09K	PDH09R	PDH12K	PDH12R	PDH15K	PDH15R
PERFORMANCE DATA:								
COOLING BTUh	7700/7600	7700	9000/8800	9000	12000/11800	12000	14500/14200	14500
POWER (WATTS) cool	640/620	640	800/770	800	1120/1120	1120	1480/1460	1480
EER	12.0/12.2	12	11.3/11.4	11.3	10.7/10.5	10.7	9.8/9.7	9.8
REVERSE HEATING BTUh	6300/6100	6300	8100/7900	8100	10700/10500	10700	13300/13000	13300
POWER (WATTS) HEAT	540/530	540	720/770	720	1010/990	1010	1300/1270	1300
COP	3.4/3.4	3.4	3.3/3.3	3.3	3.1/3.1	3.1	3.0/3.0	3
DEHUMIDIFICATION (pints/hr)	1.7	1.7	2.2	2.2	2.7	2.7	3.2	3.2
SENSIBLE HEAT RATIO	0.84	0.84	0.81	0.81	0.67	0.67	0.65	0.65
ELECTRICAL DATA:								
VOLTAGE (1 PHASE, 60 Hz)	230/208	265	230/208	265	230/208	265	230/208	265
VOLT RANGE	253-187	292-239	253-187	292-239	253-187	292-239	253-187	292-239
CURRENT (AMPS)	2.8/3.0	2.4	3.7/3.9	3.7	5.1/5.3	4.8	6.7/7.5	5.7
REVERSE HEAT. Amps	2.4/2.5	2.1	3.4/3.8	3.4	4.5/4.7	4.5	5.8/6.2	5.0
POWER FACTOR	0.97	0.99	0.99	0.99	0.99	0.99	0.98	0.98
Compressor LRA	19.0	12.0	18.5	19.0	27.00	23.0	36.0	26.0
Compressor RLA	2.8	2.4	3.6	3.2	5.0	4.3	6.5	5.3
Fan motor horsepower	0.024	0.024	0.029	0.029	0.031	0.031	0.031	0.031
AIRFLOW DATA:								
INDOOR CFM, HIGH	345/315	345	360/345	360	360/350	360	420/390	385
INDOOR CFM, MED	320/290	320	330/305	330	330/310	330	410/380	360
INDOOR CFM, LOW	295/265	295	300/270	300	310/280	310	380/350	320
VENT CFM	75	75	75	75	75	75	75	75
PHYSICAL DATA:								
DIMENSIONS	16x42x13.5	16x42x13.5	16x42x13.5	16x42x13.5	16x42x13.5	16x42x13.5	16x42x13.5	16x42x13.5
NET WEIGHT	108	108	113	113	118	118	121	123
SHIPPING WEIGHT	128	128	133	133	138	138	141	143
R-410A CHARGE (oz)	23.63	24.69	33.51	35.27	35.27	35.98	39.86	36.33

Due to continuing research in new energy-saving technology, specifications are subject to change without notice.

250 V Receptacles and Fuse Types			
AMPS	15	20	30
HEATER SIZE	0, 2.0 kW	3.0 kW	5.0 kW
RECEPTACLE			

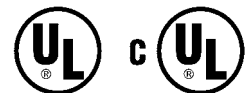

Cooling & Heating Performance

PDE 230V - Extended Cooling Performance

		OUTDOOR DRY BULB TEMP. (DEGREES F AT 40% R.H.)														
		75			85			95			105			110		
		INDOOR WET BULB TEMP. (DEGREES F AT 80 F D.B.)														
		72	67	62	72	67	62	72	67	62	72	67	62	72	67	62
PDE07	BTUh	9055	8709	8062	8624	8131	7500	8285	7700	6815	7762	6892	6075	6907	5944	5251
	WATTS	522	531	536	569	575	582	640	640	640	692	691	693	755	755	758
	AMPS	2.3	2.3	2.4	2.5	2.5	2.5	2.8	2.80	2.8	3	3	3	3.3	3.3	3.3
	SHR	0.53	0.72	0.96	0.54	0.74	0.98	0.54	0.77	0.99	0.55	0.81	0.99	0.58	0.87	0.99
PDE09	BTUh	10584	10179	9423	10080	9504	8766	9684	9000	7965	9072	8055	7101	8073	6948	6138
	WATTS	653	663	670	711	718	727	800	800	800	865	864	866	943	943	947
	AMPS	3.1	3.1	3.1	3.3	3.3	3.3	3.7	3.70	3.7	4	4	4	4.3	4.3	4.4
	SHR	0.49	0.66	0.89	0.5	0.69	0.91	0.5	0.71	0.91	0.51	0.75	0.92	0.54	0.8	0.91
PDE12	BTUh	14112	13572	12564	13440	12672	11688	12912	12000	10620	12096	10740	9468	10764	9264	8184
	WATTS	914	928	939	996	1006	1018	1120	1120	1120	1211	1210	1213	1320	1320	1326
	AMPS	4.2	4.2	4.3	4.5	4.6	4.6	5.1	5.10	5.1	5.5	5.5	5.5	6	6	6
	SHR	0.49	0.66	0.89	0.5	0.69	0.91	0.5	0.71	0.91	0.51	0.75	0.92	0.54	0.8	0.91
PDE15	BTUh	17640	16965	15705	16800	15840	14610	16140	15000	13275	15120	13425	11835	13455	11580	10230
	WATTS	1248	1268	1282	1360	1374	1391	1530	1530	1530	1654	1652	1657	1804	1804	1812
	AMPS	5.5	5.6	5.6	6	6	6	6.7	6.70	6.7	7.2	7.2	7.2	7.9	7.9	7.9
	SHR	0.47	0.63	0.85	0.48	0.66	0.87	0.48	0.68	0.87	0.49	0.72	0.88	0.51	0.77	0.87
		RATING POINT ARI 310/380														

PDH 230V - Extended Cooling Performance

		OUTDOOR DRY BULB TEMP. (DEGREES F AT 40% R.H.)														
		75			85			95			105			110		
		INDOOR WET BULB TEMP. (DEGREES F AT 80 F D.B.)														
		72	67	62	72	67	62	72	67	62	72	67	62	72	67	62
PDH07	BTUh	9055	8709	8062	8624	8131	7500	8285	7700	6815	7762	6892	6075	6907	5944	5251
	WATTS	522	531	536	569	575	582	640	640	640	692	691	693	755	755	758
	AMPS	2.3	2.3	2.4	2.5	2.5	2.5	2.8	2.80	2.8	3	3	3	3.3	3.3	3.3
	SHR	0.53	0.72	0.96	0.54	0.74	0.98	0.54	0.77	0.99	0.55	0.81	0.99	0.58	0.87	0.99
PDH09	BTUh	10584	10179	9423	10080	9504	8766	9684	9000	7965	9072	8055	7101	8073	6948	6138
	WATTS	653	663	670	711	718	727	800	800	800	865	864	866	943	943	947
	AMPS	3.1	3.1	3.1	3.3	3.3	3.3	3.7	3.70	3.7	4	4	4	4.3	4.3	4.4
	SHR	0.49	0.66	0.89	0.5	0.69	0.91	0.5	0.71	0.91	0.51	0.75	0.92	0.54	0.8	0.91
PDH12	BTUh	14112	13572	12564	13440	12672	11688	12912	12000	10620	12096	10740	9468	10764	9264	8184
	WATTS	914	928	939	996	1006	1018	1120	1120	1120	1211	1210	1213	1320	1320	1326
	AMPS	4.2	4.2	4.3	4.5	4.6	4.6	5.1	5.10	5.1	5.5	5.5	5.5	6	6	6
	SHR	0.49	0.66	0.89	0.5	0.69	0.91	0.5	0.71	0.91	0.51	0.75	0.92	0.54	0.8	0.91
PDH15	BTUh	17052	16400	15182	16240	15312	14123	15602	14500	12833	14616	12978	11441	13007	11194	9889
	WATTS	1208	1227	1240	1316	1329	1345	1480	1480	1480	1600	1598	1603	1745	1745	1752
	AMPS	5.4	5.5	5.5	5.9	5.9	5.9	6.5	6.6	6.6	7.1	7.1	7.1	7.7	7.7	7.7
	SHR	0.48	0.65	0.88	0.49	0.68	0.89	0.49	0.70	0.9	0.5	0.74	0.9	0.53	0.79	0.9
		RATING POINT ARI 310/380														

Extended Heating Performance

		OUTDOOR DRY BULB TEMP. (DEGREES F)				
		37	42	47	52	57
PDH07	BTUh	5250	5540	6300	6900	7620
	WATTS	509	518	540	549	580
	AMPS	2.3	2.4	2.4	2.5	2.6
PDH09	BTUh	6005	6399	8100	8647	9245
	WATTS	647	666	720	725	735
	AMPS	3.3	3.3	3.4	3.4	3.5
PDH12	BTUh	7726	8531	10700	11278	12234
	WATTS	883	917	1010	1039	1073
	AMPS	4	4.1	4.5	4.7	4.9
PDH15	BTUh	10530	10850	13300	14550	15940
	WATTS	1197	1212	1300	1377	1439
	AMPS	5.3	5.4	5.8	6.1	6.3
		RATING POINT ARI 310/380				

Cooling & Heating Performance

PDE 265V - Extended Cooling Performance

		OUTDOOR DRY BULB TEMP. (DEGREES F AT 40% R.H.)														
		75			85			95			105			110		
		INDOOR WET BULB TEMP. (DEGREES F AT 80 F D.B.)														
		72	67	62	72	67	62	72	67	62	72	67	62	72	67	62
PDE07	BTUh	9055	8709	8062	8624	8131	7500	8285	7700	6815	7762	6892	6075	6907	5944	5251
	WATTS	522	531	536	569	575	582	640	640	640	692	691	693	755	755	758
	AMPS	2	2	2	2.1	2.1	2.2	2.4	2.40	2.4	2.6	2.6	2.6	2.8	2.8	2.8
	SHR	0.53	0.72	0.96	0.54	0.74	0.98	0.54	0.77	0.99	0.55	0.81	0.99	0.58	0.87	0.99
PDE09	BTUh	10584	10179	9423	10080	9504	8766	9684	9000	7965	9072	8055	7101	8073	6948	6138
	WATTS	653	663	670	711	718	727	800	800	800	865	864	866	943	943	947
	AMPS	3.1	3.1	3.1	3.3	3.3	3.3	3.7	3.70	3.7	4	4	4	4.3	4.3	4.4
	SHR	0.49	0.66	0.89	0.5	0.69	0.91	0.5	0.71	0.91	0.51	0.75	0.92	0.54	0.8	0.91
PDE12	BTUh	14112	13572	12564	13440	12672	11688	12912	12000	10620	12096	10740	9468	10764	9264	8184
	WATTS	914	928	939	996	1006	1018	1120	1120	1120	1211	1210	1213	1320	1320	1326
	AMPS	4	4	4	4.3	4.3	4.3	4.8	4.80	4.8	5.2	5.2	5.2	5.6	5.6	5.7
	SHR	0.49	0.66	0.89	0.5	0.69	0.91	0.5	0.71	0.91	0.51	0.75	0.92	0.54	0.8	0.91
PDE15	BTUh	17640	16965	15705	16800	15840	14610	16140	15000	13275	15120	13425	11835	13455	11580	10230
	WATTS	1248	1268	1282	1360	1374	1391	1530	1530	1530	1654	1652	1657	1804	1804	1812
	AMPS	4.9	4.9	5	5.3	5.3	5.3	5.9	5.90	5.9	6.3	6.3	6.4	6.9	6.9	7
	SHR	0.47	0.63	0.85	0.48	0.66	0.87	0.48	0.68	0.87	0.49	0.72	0.88	0.51	0.77	0.87
		RATING POINT ARI 310/380														

PDH 265V - Extended Cooling Performance

		OUTDOOR DRY BULB TEMP. (DEGREES F AT 40% R.H.)														
		75			85			95			105			110		
		INDOOR WET BULB TEMP. (DEGREES F AT 80 F D.B.)														
		72	67	62	72	67	62	72	67	62	72	67	62	72	67	62
PDH07	BTUh	9055	8709	8062	8624	8131	7500	8285	7700	6815	7762	6892	6075	6907	5944	5251
	WATTS	522	531	536	569	575	582	640	640	640	692	691	693	755	755	758
	AMPS	2	2	2	2.1	2.1	2.2	2.4	2.40	2.4	2.6	2.6	2.6	2.8	2.8	2.8
	SHR	0.53	0.72	0.96	0.54	0.74	0.98	0.54	0.77	0.99	0.55	0.81	0.99	0.58	0.87	0.99
PDH09	BTUh	10584	10179	9423	10080	9504	8766	9684	9000	7965	9072	8055	7101	8073	6948	6138
	WATTS	653	663	670	711	718	727	800	800	800	865	864	866	943	943	947
	AMPS	3.1	3.1	3.1	3.3	3.3	3.3	3.7	3.70	3.7	4	4	4	4.3	4.3	4.4
	SHR	0.49	0.66	0.89	0.5	0.69	0.91	0.5	0.71	0.91	0.51	0.75	0.92	0.54	0.8	0.91
PDH12	BTUh	14112	13572	12564	13440	12672	11688	12912	12000	10620	12096	10740	9468	10764	9264	8184
	WATTS	914	928	939	996	1006	1018	1120	1120	1120	1211	1210	1213	1320	1320	1326
	AMPS	4	4	4	4.3	4.3	4.3	4.8	4.80	4.8	5.2	5.2	5.2	5.6	5.6	5.7
	SHR	0.49	0.66	0.89	0.5	0.69	0.91	0.5	0.71	0.91	0.51	0.75	0.92	0.54	0.8	0.91
PDH15	BTUh	17052	16400	15182	16240	15312	14123	15602	14500	12833	14616	12978	11441	13007	11194	9889
	WATTS	1208	1227	1240	1316	1329	1345	1480	1480	1480	1600	1598	1603	1745	1745	1752
	AMPS	4.7	4.7	4.8	5.1	5.1	5.1	5.7	5.7	5.7	6.1	6.1	6.2	6.7	6.7	6.7
	SHR	0.48	0.65	0.88	0.49	0.68	0.89	0.49	0.70	0.9	0.5	0.74	0.9	0.53	0.79	0.9
		RATING POINT ARI 310/380														

Extended Heating Performance

		OUTDOOR DRY BULB TEMP. (DEGREES F)				
		37	42	47	52	57
PDH07	BTUh	5250	5540	6300	6900	7620
	WATTS	509	518	540	549	580
	AMPS	2.3	2.4	2.4	2.5	2.6
PDH09	BTUh	6005	6399	8100	8647	9245
	WATTS	647	656	720	725	735
	AMPS	3.3	3.3	3.4	3.4	3.5
PDH12	BTUh	7726	8531	10700	11278	12234
	WATTS	883	917	1010	1039	1073
	AMPS	4	4.1	4.5	4.7	4.9
PDH15	BTUh	10530	10850	13300	14550	15940
	WATTS	1197	1212	1300	1377	1439
	AMPS	4.5	4.6	5	5.3	5.5
		RATING POINT ARI 310/380				

Electric Heat Data

Electric Heat Data

	PDE07K0	PDE/PDH07K				PDE/PDH07R	
HEATER WATTS	0 Kw	2000	1635	3000	2450	2000	3000
VOLTAGE	230/208	230	208	230	208	265	
HEATING BTUh	0	6824	5580	10236	8360	6824	10236
HEATING CURRENT (AMPS)	0	8.9	7.9	13.2	12.2	7.6	11.4
MINIMUM CIRCUIT AMPACITY	4.0	11.4	10.0	16.8	15.6	9.6	14.6
BRANCH CIRCUIT FUSE (AMPS)	15	15	15	20	20	15	20

Electric Heat Data

	PDE09K0	PDE/PDH09K						PDE/PDH09R		
HEATER WATTS	0 Kw	2000	1635	3000	2450	5000	4090	2000	3000	5000
VOLTAGE	230/208	230	208	230	208	230	208	265		
HEATING BTUh	0	6824	5580	10236	8360	17060	13960	6824	10236	17060
HEATING CURRENT (AMPS)	0	8.9	7.9	13.2	12.2	21.5	20.5	7.6	11.4	19.0
MINIMUM CIRCUIT AMPACITY	5.2	11.4	10.0	16.8	15.6	27.2	26.0	9.8	14.6	24.1
BRANCH CIRCUIT FUSE (AMPS)	15	15	15	20	20	30	30	15	20	30

Electric Heat Data

	PDE12K0	PDE/PDH12K						PDE/PDH12R		
HEATER WATTS	0 Kw	2000	1635	3000	2450	5000	4090	2000	3000	5000
VOLTAGE	230/208	230	208	230	208	230	208	265		
HEATING BTUh	0	6824	5580	10236	8360	17060	13960	6824	10236	17060
HEATING CURRENT (AMPS)	0	8.9	7.9	13.2	12.2	21.5	20.5	7.6	11.4	19.0
MINIMUM CIRCUIT AMPACITY	7.1	11.4	10.0	16.8	15.6	27.2	26.0	9.8	14.6	24.1
BRANCH CIRCUIT FUSE (AMPS)	15	15	15	20	20	30	30	15	20	30

Electric Heat Data

	PDE15K0	PDE/PDH15K						PDE/PDH15R		
HEATER WATTS	0 Kw	2000	1635	3000	2450	5000	4090	2000	3000	5000
VOLTAGE	230/208	230	208	230	208	230	208	265		
HEATING BTUh	0	6824	5580	10236	8360	17060	13960	6824	10236	17060
HEATING CURRENT (AMPS)	0	8.9	7.9	13.2	12.2	21.5	20.5	7.6	11.4	19.0
MINIMUM CIRCUIT AMPACITY	9.1	11.4	10.0	16.8	15.6	27.2	26.0	9.8	14.6	24.1
BRANCH CIRCUIT FUSE (AMPS)	15	15	15	20	20	30	30	15	20	30

ELECTRICAL RATING TABLES

⚠ WARNING

ELECTRIC SHOCK HAZARD

Turn off electric power before service or installation. All electrical connections and wiring **MUST** be installed by a qualified electrician and conform to the National Electrical Code and all local codes which have jurisdiction. Failure to do so could result in serious personal injury or death.

NOTE: Use Copper Conductors ONLY. Wire sizes are per NEC, check local codes for overseas applications.

AMPS	15	20*	30
RECEPTACLE			
TIME-DELAY TYPE FUSE (or HACR circuit breaker)	15	20	30

HACR – Heating, Air Conditioning, Refrigeration
 * May be used for 15 Amp applications if fused for 15 Amp
 NOTE: 265 volt units are hard wired.

NAMEPLATE / MAXIMUM CIRCUIT BREAKER SIZE	AWG WIRE SIZE**
15	14
20	12
30	10

AWG – American Wire Gauge
 * Single circuit from main box
 ** Based on copper wire, single insulated conductor at 60°C

WIRE SIZE	Use ONLY wiring size recommended for single outlet branch circuit.
FUSE/CIRCUIT BREAKER	Use ONLY type and size fuse or HACR circuit breaker indicated on unit's rating plate. Proper current protection to the unit is the responsibility of the owner. NOTE: A time delay fuse is provided with 265V units.
GROUNDING	Unit MUST be grounded from branch circuit through service cord to unit, or through separate ground wire provided on permanently connected units. Be sure that branch circuit or general purpose outlet is grounded. The field supplied outlet must match plug on service cord and be within reach of service cord. Refer to Table 1 for proper receptacle and fuse type. Do NOT alter the service cord or plug. Do NOT use an extension cord.
RECEPTACLE	The field supplied outlet must match plug on service cord and be within reach of service cord. Refer to Table 1 for proper receptacle and fuse type. Do NOT alter the service cord or plug. Do NOT use an extension cord.
WIRE SIZING	Use recommended wire size given in Table 2 and install a single branch circuit. All wiring must comply with local and national codes. NOTE: Use copper conductors only.

POWER CORD INFORMATION (230/208V MODELS ONLY)

All Friedrich 230/208V PTAC units are shipped from the factory with a Leakage Current Detection Interrupter (LCDI) equipped power cord. The LCDI device meets the UL and NEC requirements for cord connected air conditioners effective August 2004.

To test your power supply cord:

1. Plug power supply cord into a grounded 3 prong outlet.
2. Press RESET.
3. Press TEST (listen for click; Reset button trips and pops out).
4. Press and release RESET (listen for click; Reset button latches and remains in). The power supply cord is ready for operation.

NOTE: The LCDI device is not intended to be used as a switch.

Once plugged in the unit will operate normally without the need to reset the LCDI device. If the LCDI device trips and

Typical LCDI Devices

15/20A LCDI Device

30A LCDI Device

FRP014

Model	Heater kW	Power Cord Kit	Voltage	Amperage	Receptacle
PDE07K	0.0	PXPC23000	230/208	15	NEMA.6-15r
PDE/PDH07K	2.0	PXPC23015	230/208	15	NEMA.6-15r
	3.0	STD	230/208	20	NEMA.6-20r
PDE09K	0.0	PXPC23000	230/208	15	NEMA.6-15r
PDE/PDH09K	2.0	PXPC23015	230/208	15	NEMA.6-15r
	3.0	STD	230/208	20	NEMA.6-20r
PDE12K	5.0	PXPC23030	230/208	30	NEMA.6-30r
	0.0	PXPC23000	230/208	15	NEMA.6-15r
	2.0	PXPC23015	230/208	15	NEMA.6-15r
PDE/PDH12K	3.0	STD	230/208	20	NEMA.6-20r
	5.0	PXPC23030	230/208	30	NEMA.6-30r
	0.0	PXPC23000	230/208	15	NEMA.6-15r
PDE/PDH15K	2.0	PXPC23015	230/208	15	NEMA.6-15r
	3.0	PXPC23020	230/208	20	NEMA.6-20r
	5.0	STD	230/208	30	NEMA.6-30r
PDE/PDH07R	2.0	PXPC26515	265	15	NEMA.6-15r
	3.0	STD	265	20	NEMA.6-20r
PDE/PDH09R	2.0	PXPC26515	265	15	NEMA.6-15r
	3.0	STD	265	20	NEMA.6-20r
	5.0	PXPC26530	265	30	NEMA.6-30r
PDE/PDH12R	2.0	PXPC26515	265	15	NEMA.6-15r
	3.0	STD	265	20	NEMA.6-20r
	5.0	PXPC26530	265	30	NEMA.6-30r
PDE/PDH15R	2.0	PXPC26515	265	15	NEMA.6-15r
	3.0	PXPC26520	265	20	NEMA.6-20r
	5.0	STD	265	30	NEMA.6-30r

Electrical Wiring for 265 Volt Models

Power Cord Installation

All 265V PTAC/PTHP units come with a factory installed non-LCDI power cord for use in a subbase. If the unit is to be hard-wired refer to the instructions below.

NOTE: It is recommended that the PXSBB subbase assembly, the PXCJA conduit kit (or equivalent) be installed on all hardware units. If installing a flush-floor mounted unit, make sure the chassis can be removed from the sleeve for service and maintenance.

To install the line voltage power leads and conduit to chassis, follow the instructions below. PXCJA Conduit Kit is required with this setup.

1. Follow the removal process of the chassis's junction box listed in the installation manual (Figure 25, step 2, page 19).
2. Prepare the 265V (or 230V) power cord for connection to the chassis' power cord connector by cutting the cord to the appropriate length (Figure 15). Power cord harness selection shown on Table above.

⚠ WARNING



Electrical Shock Hazard

Turn off electrical power before service or installation.

ALL electrical connections and wiring **MUST** be installed by a qualified electrician and conform to the National Code and all local codes which have jurisdiction.

Failure to do so can result in property damage, personal injury and/or death.

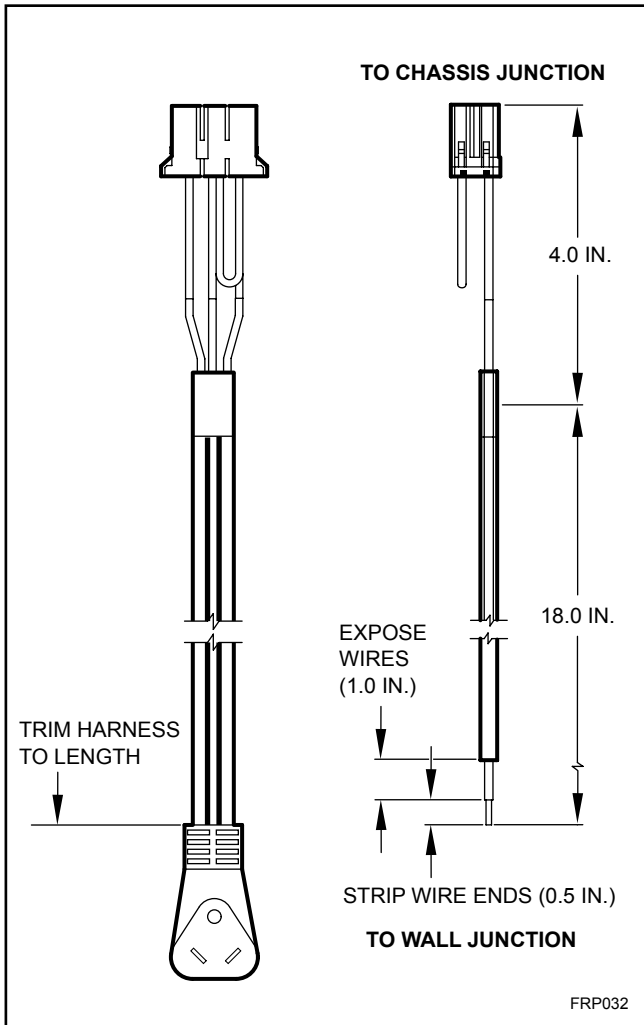

3. Route the cut ends of harness through the conduit connector assembly and flex conduit sleeve. Be sure to use the supplied conduit bushing to prevent damage to the cord by the conduit.

The cord should pass through the Locknut, Spacer, Chassis Junction Box, Conduit Connector, Bushing, then the Conduit Sleeve. Refer to wire harness insertion diagram.

4. Route the cut ends of the power cord through the elbow connector at the other end of the conduit. Tighten screws on elbow connector to secure conduit sleeve.
5. Fasten and secure the elbow connector to the wall junction box cover with locknut. Place and mount the wall junction box with the four wall mounting screws making sure to pass the wall lines through the junction box. Connect and join all wall lines with the stripped ends using wire nuts. Tighten both screws of the wall junction box cover to junction box.

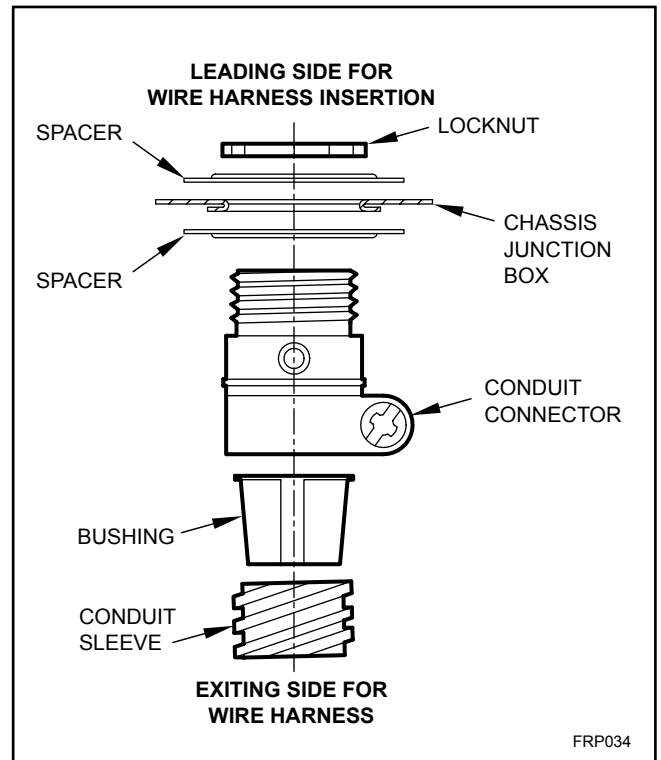
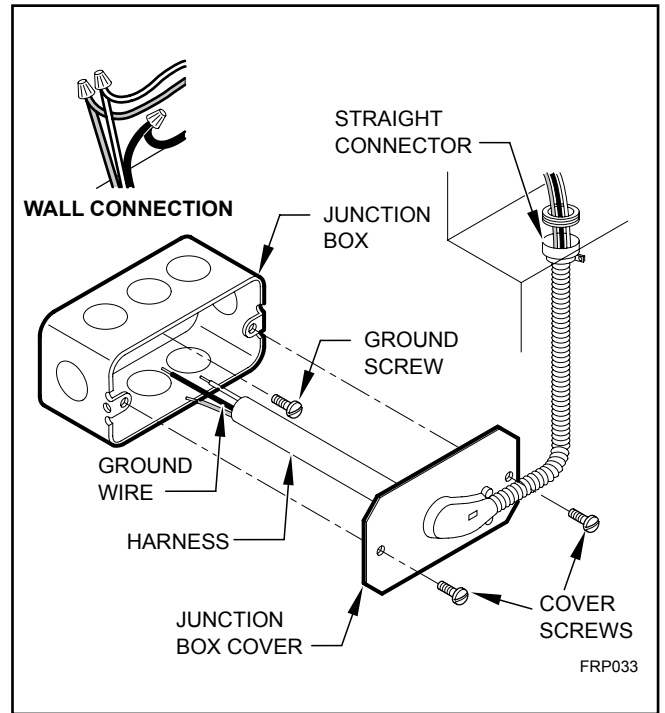

Remote Control Thermostat Installation

Install Thermostat

1. Approximately 5 ft. from the floor.
2. Close to or in a frequently used room, preferably on an inside wall.
3. On a section of wall without pipes or ductwork.

The Thermostat should NOT be mounted:

1. Close to a window, on an outside wall, or next to a door leading outside.
2. Where it can be exposed to direct sunlight or heat, such as the sun, a lamp, fireplace, or any temperature radiating object which may cause a false reading.
3. Close to or in the direct airflow of supply registers and/or return air grilles.
4. Any areas with poor air circulation, such as a corner, behind a door, or an alcove.

Remote Thermostat and Low Voltage Control Connections

Remote Thermostat

All Friedrich PD model PTAC units are factory configured to be controlled by either the chassis mounted Smart Center or a 24V remote wall mounted thermostat. The thermostat may be auto or manual changeover as long as the control configuration matches that of the PTAC unit.

NOTE: All PDE models require a single stage cool, single stage heat thermostat. All PDH models require a single stage cool, dual stage heat thermostat with an O reversing valve control. The Friedrich RT6 thermostat can be configured for either model.

To control the unit with a wall mounted thermostat follow the steps below:

1. Unplug the unit before doing any work.
2. With the front cover removed locate the dip switches located below the Smart Center control panel. Switch Dip switch 2 to the up on 'ON' position.
3. Remove the low voltage terminal block from the unit.
4. Connect the corresponding terminals from the wall thermostat to the terminal block.
5. Replace the terminal block on the unit.
6. Restore power to the unit.
7. The unit is now controlled by the wall thermostat only.
8. If the accessory escutcheon kit (PDXRTA) is to be used, install it over the existing control panel.

NOTE: The unit mounted controls no longer control the unit. To restore the unit mounted controls move dip switch 2 to the down or 'OFF' position.

Thermostat Connections

- R = 24V Power from Unit
- Y = Call for Cooling
- W = Call for Heating
- O = Reversing Valve Energized in cooling mode (PDH Models Only)
- GL = Call for Low Fan
- GH = Call for High Fan
- C = Common Ground

*If only one G terminal is present on thermostat connect to GL for low speed fan or to GH for high speed fan operation.

Control board with optional PDXRT escutcheon kit installed



FRP029

Desk Control Terminals

The Friedrich PD model PTAC has built-in provisions for connection to an external switch to control power to the unit. The switch can be a central desk control system or even a normally open door switch.



For desk control operation connect one side of the switch to the D1 terminal and the other to the D2 terminal. Whenever the switch closes the unit operation will stop.

NOTE: The desk control system and switches must be field supplied.

Energy Management

Sometimes known as Front Desk Control, an input is provided so that the unit can be manually disabled from a remote location. If the unit detects 24Vac on this input, it will automatically turn itself off. If no voltage is detected on the input, the unit will run normally.

NOTE: It is the installer's responsibility to ensure that all control wiring connections are made in accordance with the installation instructions. Improper connection of the thermostat control wiring and/or tampering with the unit's internal wiring can void the equipment warranty. Other manufacturer's PTACs and even older Friedrich models may have different control wire connections. Questions concerning proper connections to the unit should be directed to Friedrich.

 WARNING	
	<p>Electrical Shock Hazard</p> <p>Turn off electrical power before service or installation.</p> <p>ALL electrical connections and wiring MUST be installed by a qualified electrician and conform to the National Code and all local codes which have jurisdiction.</p> <p>Improper connection of the thermostat control wiring and/or tampering with the units internal wiring may result in property damage, personal injury or death.</p>

FRIEDRICH DIGITAL CONTROL FEATURES

The new Friedrich digital PTAC has state of the art features to improve guest comfort, indoor air quality and conserve energy. Through the use of specifically designed control software for the PTAC industry Friedrich has accomplished what other Manufacturer's have only attempted – a quiet, dependable, affordable and easy to use PTAC.

Below is a list of standard features on every Friedrich PTAC and their benefit to the owner.

Digital Temperature Readout	By digitally monitoring desired room temperature the room is controlled more precisely than conventional systems. The large, easy to read LED display can show either set-point or actual room temperature as selected by owner.
One-Touch Operation	When the unit is powered off the unit can be returned directly to heating or cooling mode by pressing the 'Heat' or 'Cool' buttons without the confusing power up sequence of some controls. One-touch control takes guess-work out of unit control delivering a more enjoyable experience and eliminating front-desk calls.
Individual Mode and Fan Control Buttons	By having separate control buttons and indicators for both fan and mode settings the Friedrich digital control eliminates the confusion of previous digital PTACs. The accurate temperature setting provides greater guest comfort than other systems.
Quiet Start/Stop Fan Delay	The fan start and stop delays prevent abrupt changes in room acoustics due to the compressor energizing or stopping immediately. Upon call for cooling or heating the unit fan will run for five seconds prior to energizing the compressor. Also, the fan off delay allows for "free cooling" by utilizing the already cool indoor coil to its maximum capacity by running for 30 seconds after the compressor.
Remote Thermostat Operation	Some applications require the use of a wall mounted thermostat. All new Friedrich PTACs may be switched from unit control to remote thermostat control easily without the need to order a special model or accessory kit.
Wireless Remote Control Ready	Guests can adjust the temperature and mode of the unit through the use of an optional hand held wireless remote, improving guest comfort and relaxation.
Internal Diagnostic Program	The new Friedrich digital PTAC features a self diagnostic program that can alert maintenance to component failures or operating problems. The internal diagnostic program saves properties valuable time when diagnosing running problems.
Service Error Code Storage	The self diagnosis program will also store error codes in memory if certain conditions occur and correct themselves such as extreme high or low operating conditions or activation of the room freeze protection feature. Storing error codes can help properties determine if the unit faced obscure conditions or if an error occurred and corrected itself.
Constant Comfort Room Monitoring	The on-board processor monitors time between demand cycles (heat or cool) and will cycle the fan every 9 minutes to sample the room condition and determine if the desired conditions are met. This allows the room to have similar benefits to a remote mounted stat without the complication or cost of a wall mounted thermostat.
Electronic Temperature Limiting	By limiting the operating range the property can save energy by eliminating "max cool" or "max heat" situations common with older uncontrolled systems. The new electronic control allows owners to set operating ranges for both heating and cooling independently of one another.
Room Freeze Protection	When the PTAC senses that the indoor room temperature has fallen to 40°F the unit will cycle on high fan and the electric strip heat to raise the room temperature to 46°F then cycle off again. This feature works regardless of the mode selected and can be turned off. The control will also store the Room Freeze cycle in the service code memory for retrieval at a later date. This feature ensures that unoccupied rooms do not reach freezing levels where damage can occur to plumbing and fixtures.
Random Compressor Restart	Multiple compressors starting at once can often cause electrical overloads and premature unit failure. The random restart delay eliminates multiple units from starting at once following a power outage or initial power up. The compressor delay will range from 180 to 240 seconds.

Digital Control Operation

Digital Control Panel

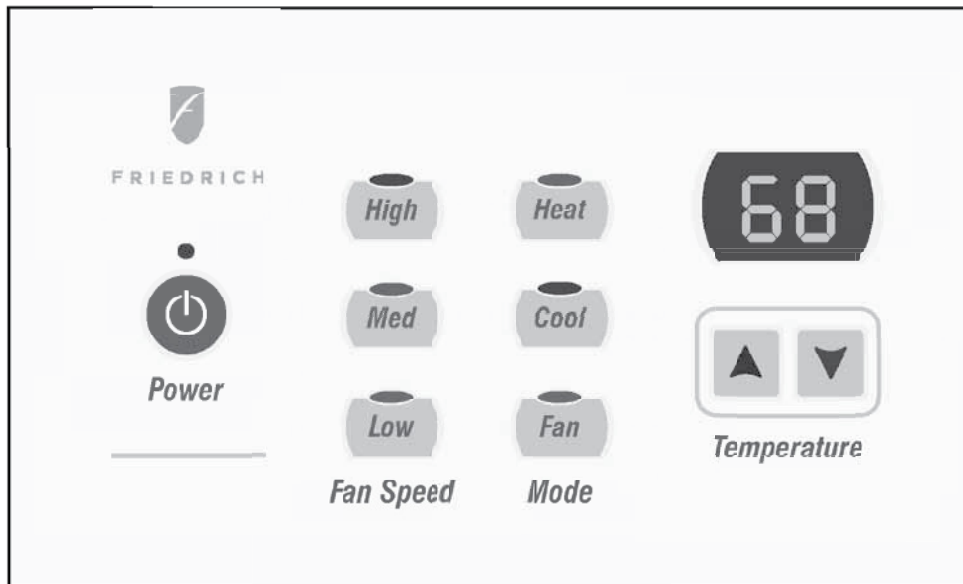

FRP030

°F vs. °C Display

The unit is factory configured to display all temperatures in degrees Fahrenheit (° F). To switch to degrees Celsius press the 'Fan Only' and 'Low Fan' buttons simultaneously for three seconds. The display will show a 'C' as acknowledgement of the change. To revert back to ° F press the 'Fan Only' and 'Low Fan' buttons simultaneously for three seconds. The display will show an 'F' as acknowledgement of the change.

Cooling Mode

Pressing the 'Cool' button while the unit is in any mode, including off, will put the unit into cooling mode. Adjust the temperature readout to the desired room temperature and the unit will cycle the compressor on and off to maintain a comfortable room. The compressor will come on anytime that the room temperature is 1.8° F above the desired temperature. The fan operation is dependent on the fan mode selected, either continuous or cycling. See Fan Mode for fan cycle control.

Heating Mode

Pressing the 'Heat' button while the unit is in any mode, including off, will put the unit into heating mode.

Heat Pump Models (PDH)

When the 'Heat' button is pressed initially the unit will energize the electric resistance heat to quickly bring the room to the set temperature. When the desired room temperature falls 1.8° F below the desired set temperature the unit will cycle the compressor on and operate as a heat pump to maintain the room temperature while running more efficiently than resistance heat only models. If the room temperature should fall more than 5° F from the set temperature the unit will run the resistance heater. The fan operation is dependent on the fan mode selected, either continuous or cycling. Dip switch 3 controls the fan mode, see page 23 for setting.

When the outdoor coil temperature falls below 30° F for more than 2 minutes the unit will operate the resistance heaters and not the compressor. When the outdoor coil temperature reaches 45° F the compressor will be allowed to operate again.

Heat/Cool Models (PDE)

After pressing the 'Heat' button, adjust the temperature readout to the desired room temperature and the unit will cycle the resistance heat on and off to maintain a comfortable room. The heater will come on anytime that the room temperature is 1.8° F below the desired temperature. The fan operation is dependent on the fan mode selected, either continuous or cycling. Dip switch 3 controls the fan mode, see page 23 for setting.

Emergency Heat Operation

In the event of a compressor failure in heat pump mode the compressor may be locked out to provide heat through the resistance heater. This feature ensures that even in the unlikely event of a compressor failure the room temperature can be maintained until the compressor can be serviced. Dip switch 1 controls the emergency heat setting, see page 23.

Fan Mode

All units are shipped with fan mode set to continuous for cooling and cycle for heating.

Fan Only Mode

Pressing the 'Fan' button will run the fan to allow for air circulation in the room without operating the compressor or heater regardless of the room or set temperature. The fan speed selection is made by pressing either the 'High Fan', 'Med Fan' or 'Low Fan' button.

Cycle/Continuous

The owner may choose between fan cycling or fan continuous mode based on property preference (Note: Even heat monitoring and quiet start/stop fan delay only operate in fan cycle mode). Fan continuous mode is used to keep constant airflow circulation in the room during all times the unit is 'ON'. Fan cycle will conserve energy by only operating the fan while the compressor or electric heater is operating. Dip switch 3-4 controls the fan mode, see page 23 for setting.

Digital Control User Input Configuration

The adjustable control dip switches are located at the lower left hand portion of the digital Smart Center. The inputs are only visible and accessible with the front cover removed from the PTAC.

Dip Switch Setting

1. **Emergency Heat Override – Switch 1**
In the unlikely event of a compressor failure a heat pump unit may be switched to operate in only the electric heat mode until repairs can be made. Moving Dip Switch 1 to 'ON'.
2. **Wall Thermostat Switch 2**
In order to enable the wall thermostat move Dip Switch to 'ON'.
3. **Fan Cycle Control – Switch 3-4**
All PTACs are shipped from the factory with Dip Switch 3-4 in the 'OFF' position. In this position the cooling fan cycle will run continuously providing air circulation during the warm months. The heating fan cycle is set to 'cycle' on and off. The fan may be set to 'continuous' mode by switching Dip Switch 3 to 'ON' position.
4. **Electronic Temperature Limiting – Switches 5-6**
The digital control is set from the factory to allow a temperature range between 61° F and 86° F in both heating and cooling mode. Dip Switches 5-6 can be used to set high and low limits for either heating both, cooling both or both.

From the factory switches are in the down 'OFF' position. The chart below shows the available electronic limiting ranges.
5. **Room Freeze Protection – Switch 7**
Units are shipped from the factory with the room freeze protection enabled. Room Freeze Protection can be switched off at the owner's preference by moving Dip Switch 7 to 'OFF'. This feature will monitor the indoor room conditions and in the event that the room falls below 40°F the unit will cycle on high fan with the electric heater. This occurs regardless of mode.

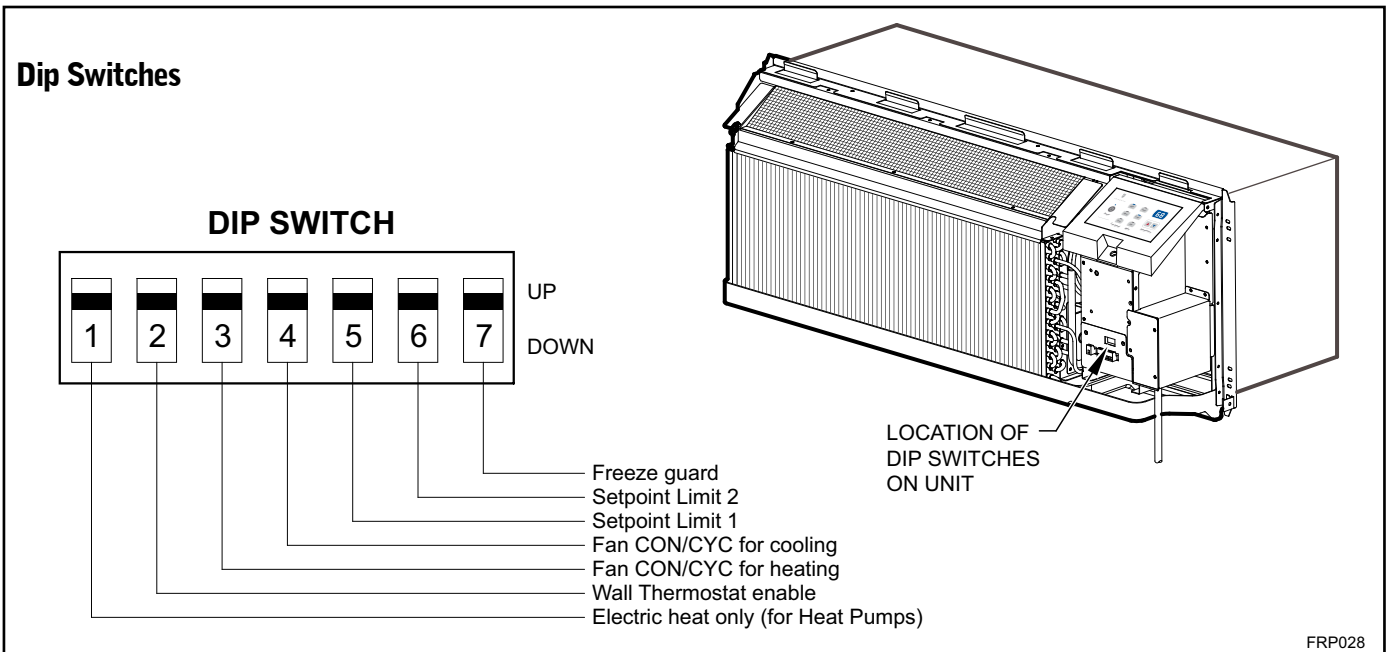

Switch	Description	Function	Factory Setting				Option			
1	Emergency Heat Override for PDH Heat Pump Models	Enables electric heat only operation in the event of a compressor failure on HP models.	Down - Normal Operation				Up - Overrides compressor operation. (PDH models only)			
2	Wall Thermostat Switch	Enables the use of a wall thermostat or unit controls	Down - Unit Controls				Up - Enables Wall Thermostat Usage			
3	Fan Cycle for Heating	Allows selection of continuous fan or cycling in heating mode.	Down - Cycle				Up - Continuous			
4	Fan Cycle for Cooling	Allows selection of continuous fan or cycling in cooling mode.	Down - Continuous				Up - Cycle			
5	Setpoint Switch 1	Allows the temperature setpoint range to be adjusted.	Down	61F-86F	Up	63F-80F	Down	65F-78F	Up	68F-75F
6	Setpoint Switch 2		Down	(16C-30C)	Down	(18C-28C)	Up	(19C-26C)	Up	(20C-24C)
7	Room Freeze Protection	Allows the unit to ensure the indoor room temperature does not fall below 40F even when turned off.	Down - Freeze Protection Enabled				Up - Freeze Protection Disabled			

DIGITAL CONTROL DIAGNOSTICS

The chart below lists malfunctions and their description.

1	Indoor air temp sensor open/short	Display 'F1', with STATUS light flash
2	Indoor coil sensor open or short	Display 'F2', with STATUS light flash
3	Outdoor coil sensor open/short	Display 'F4', with STATUS light flash
4	Freeze Guard protection	Display 'FP', with STATUS light flash
5	Indoor coil high temp protection	STATUS light flash 8 times and off 3 sec, repeat
6	Outdoor coil high temp protection	STATUS light flash 6 times and off 3 sec, repeat
7	Indoor coil freeze protection	STATUS light flash 5 times and off 3 sec, repeat
8	Defrost (heat pump type)	STATUS light flash 7 times and off 3 sec, repeat
9	Thermostat wiring error	STATUS light flash 9 times and off 3 sec, repeat

MALFUNCTION ANALYSIS

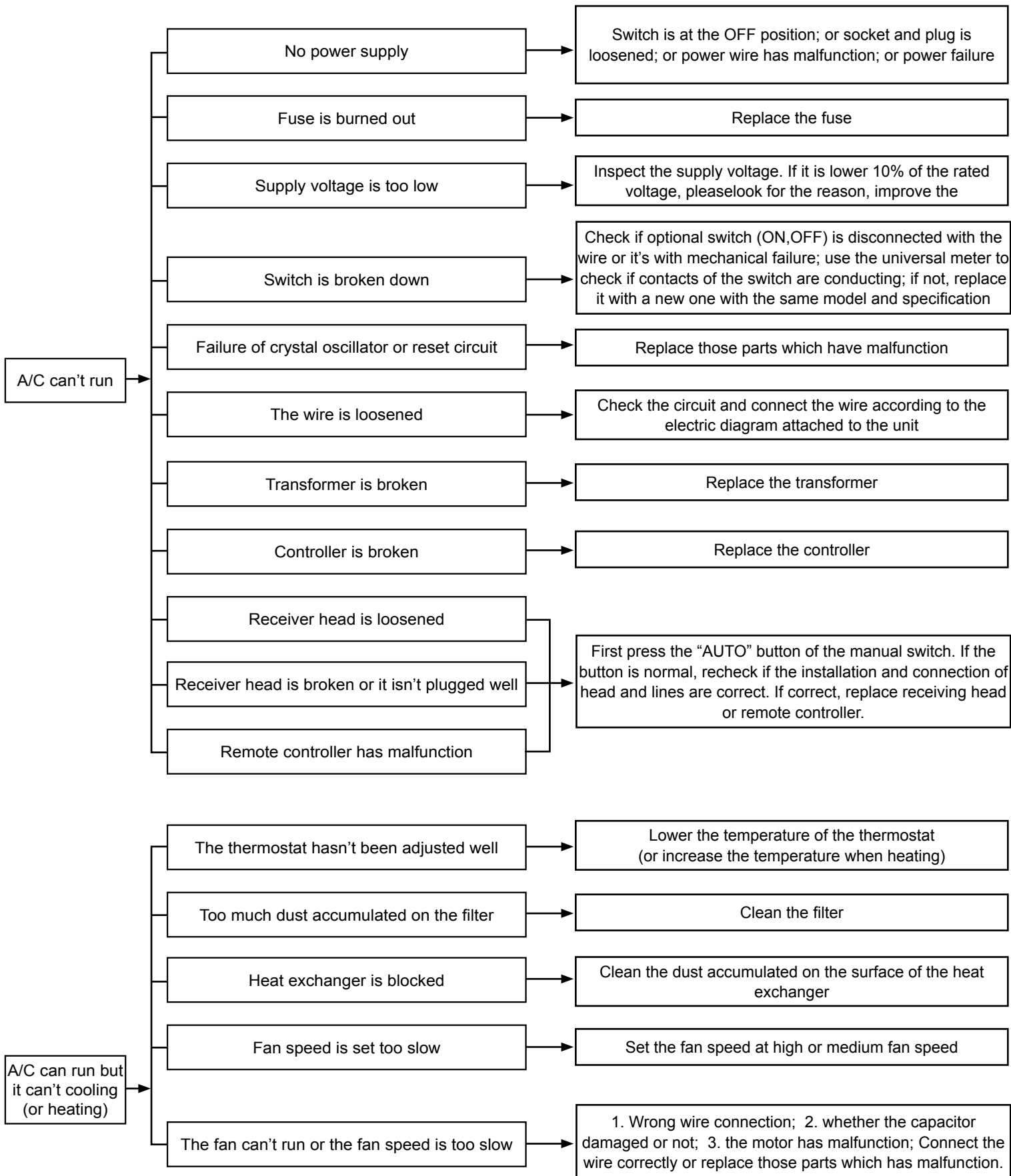

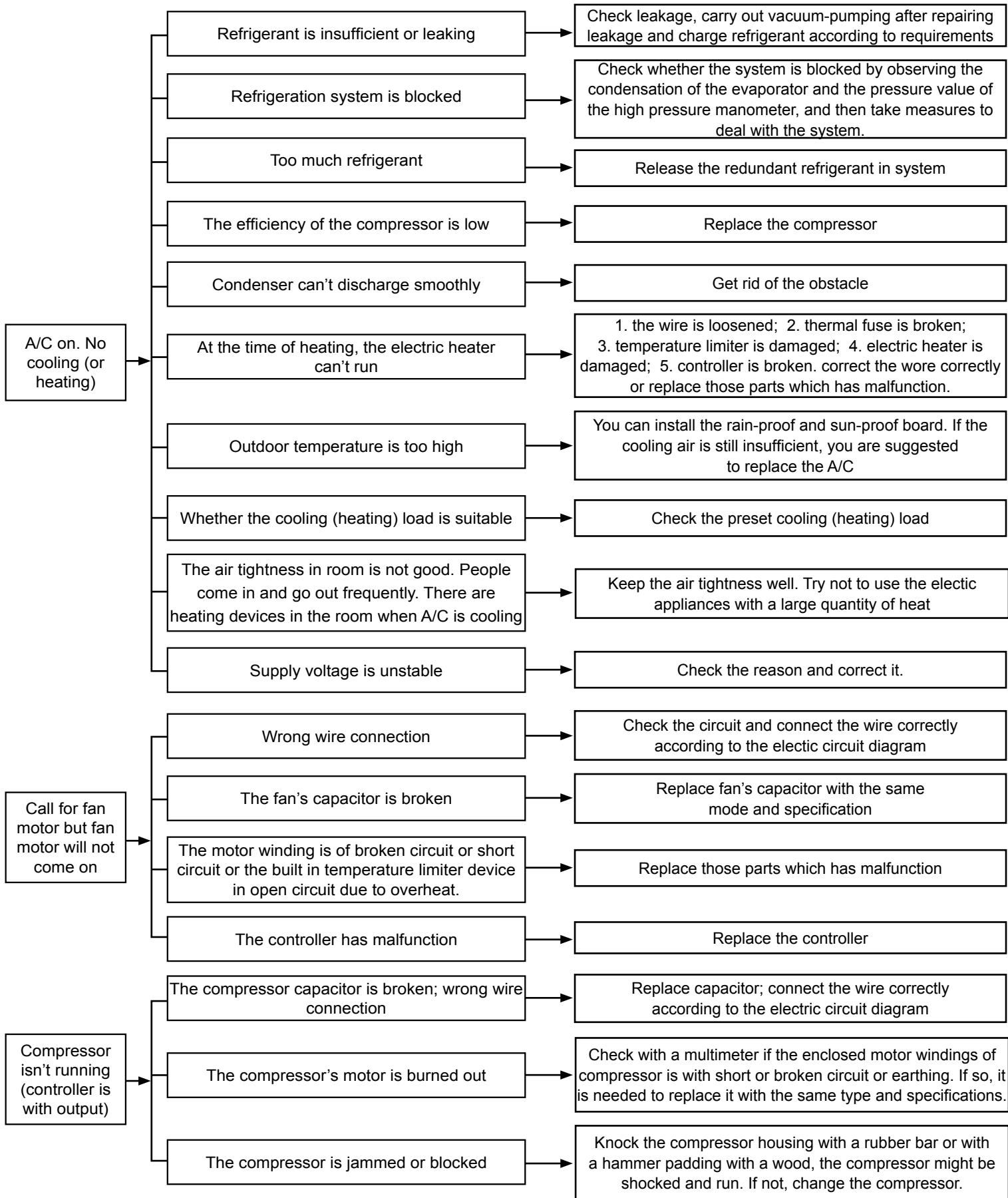

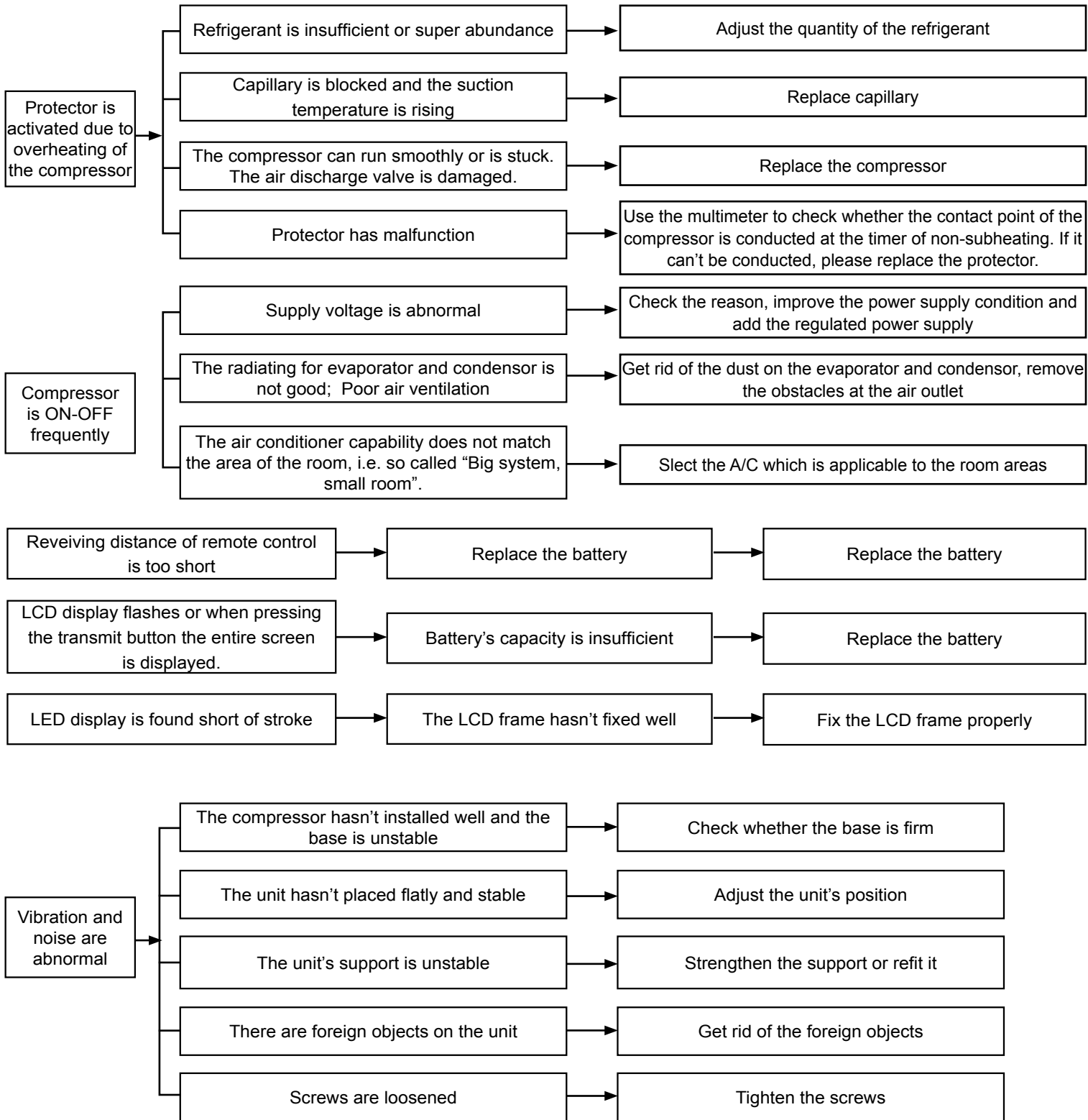

As for the above malfunction analysis, there aren't malfunction related to heating for the cooling only unit.

COMPONENTS TESTING

BLOWER / FAN MOTOR

A single phase permanent split capacitor motor is used to drive the evaporator blower and condenser fan. A self-resetting overload is located inside the motor to protect against high temperature and high amperage conditions.

⚠ WARNING	
	<p>ELECTRIC SHOCK HAZARD Disconnect power to the unit before servicing. Failure to follow this warning could result in serious injury or death.</p>

BLOWER / FAN MOTOR TEST

1. Make sure the motor has cooled down.
2. Disconnect the fan motor wires from the control board.
3. Test for continuity between the windings also, test to ground.
4. If any winding is open or grounded replace the motor.

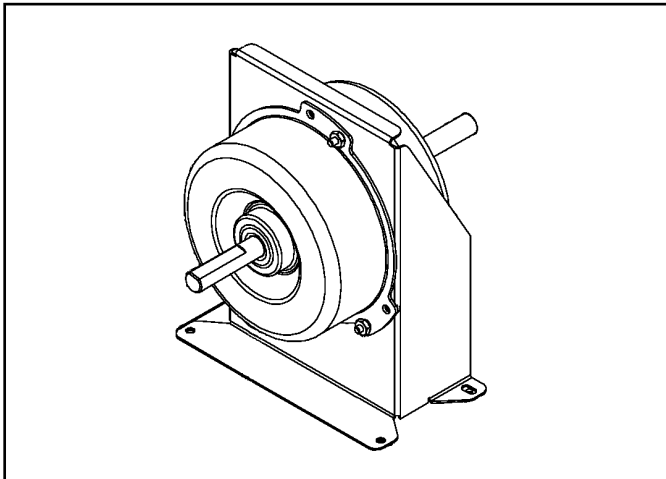

CAPACITORS

⚠ WARNING	
	<p>ELECTRIC SHOCK HAZARD Turn off electric power before servicing. Discharge capacitor with a 20,000 Ohm 2 Watt resistor before handling. Failure to do so may result in personal injury, or death.</p>

Many motor capacitors are internally fused. Shorting the terminals will blow the fuse, ruining the capacitor. A 20,000 ohm 2 watt resistor can be used to discharge capacitors safely. Remove wires from capacitor and place resistor across terminals. When checking a dual capacitor with a capacitor analyzer or ohmmeter, both sides must be tested.

Capacitor Check with Capacitor Analyzer

The capacitor analyzer will show whether the capacitor is “open” or “shorted.” It will tell whether the capacitor is within its micro farads rating and it will show whether the capacitor is operating at the proper power-factor percentage. The instrument will automatically discharge the capacitor when the test switch is released.

Capacitor Connections

The starting winding of a motor can be damaged by a shorted and grounded running capacitor. This damage usually can be avoided by proper connection of the running capacitor terminals.

From the supply line on a typical 230 volt circuit, a 115 volt potential exists from the “R” terminal to ground through a possible short in the capacitor. However, from the “S” or start terminal, a much higher potential, possibly as high as 400 volts, exists because of the counter EMF generated in the start winding. Therefore, the possibility of capacitor failure is much greater when the identified terminal is connected to the “S” or start terminal. The identified terminal should always be connected to the supply line, or “R” terminal, never to the “S” terminal.

When connected properly, a shorted or grounded running capacitor will result in a direct short to ground from the “R” terminal and will blow the line fuse. The motor protector will protect the main winding from excessive temperature.

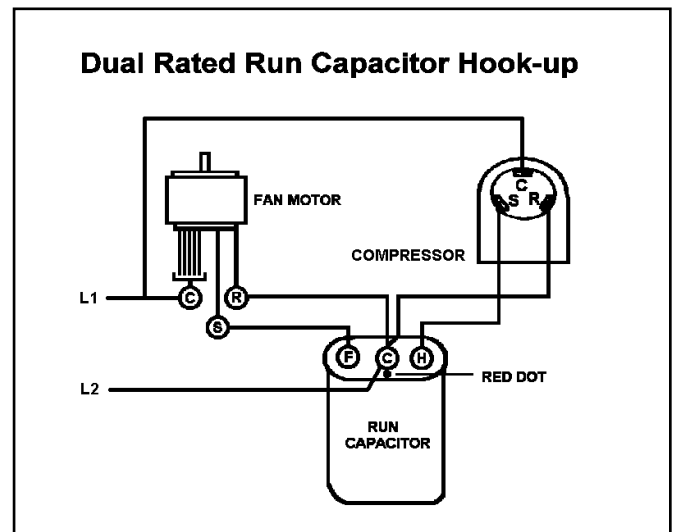

COMPONENTS TESTING (Continued)

HEATER ELEMENTS AND LIMIT SWITCHES' SPECIFICATIONS

All heat pumps and electric heat models are equipped with a heating element and a limit switch (bimetal thermostat). The limit is in series with the element and will interrupt the power at a designed temperature.

Should the blower motor fail, filter become clogged or air-flow be restricted etc., the high limit switch will open and interrupt the power to the heater before reaching an unsafe temperature condition.

TESTING THE HEATING ELEMENTS AND LIMIT SWITCHES

⚠ WARNING	
	ELECTRIC SHOCK HAZARD Disconnect power to the unit before servicing. Failure to follow this warning could result in serious injury or death.

Testing of the heating elements can be made with an ohmmeter or continuity tester across the terminals after the power wires have been removed. Test the limit switch for continuity across its input and output terminals. Test below the limit switch's reset temperature.

DRAIN PAN VALVE

During the cooling mode of operation, condensate which collects in the drain pan is picked up by the condenser fan blade and sprayed onto the condenser coil. This assists in cooling the refrigerant plus evaporating the water.

During the heating mode of operation, it is necessary that water be removed to prevent it from freezing during cold outside temperatures. This could cause the condenser fan blade to freeze in the accumulated water and prevent it from turning.

To provide a means of draining this water, a bellows type drain valve is installed over a drain opening in the base pan.

This valve is temperature sensitive and will open when the outside temperature reaches 40°F. The valve will close gradually as the temperature rises above 40°F to fully close at 60°F.

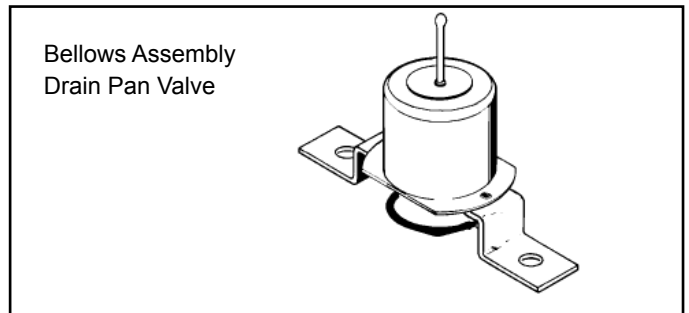

REFRIGERATION SEQUENCE OF OPERATION

A good understanding of the basic operation of the refrigeration system is essential for the service technician. Without this understanding, accurate troubleshooting of refrigeration system problems will be more difficult and time consuming, if not (in some cases) entirely impossible. The refrigeration system uses four basic principles (laws) in its operation they are as follows:

1. "Heat always flows from a warmer body to a cooler body."
2. "Heat must be added to or removed from a substance before a change in state can occur"
3. "Flow is always from a higher pressure area to a lower pressure area."
4. "The temperature at which a liquid or gas changes state is dependent upon the pressure."

The refrigeration cycle begins at the compressor. Starting the compressor creates a low pressure in the suction line which draws refrigerant gas (vapor) into the compressor. The compressor then "compresses" this refrigerant, raising its pressure and its (heat intensity) temperature.

The refrigerant leaves the compressor through the discharge Line as a hot High pressure gas (vapor). The refrigerant enters the condenser coil where it gives up some of its heat. The condenser fan moving air across the coil's finned surface facilitates the transfer of heat from the refrigerant to the relatively cooler outdoor air.

When a sufficient quantity of heat has been removed from the refrigerant gas (vapor), the refrigerant will "condense" (i.e. change to a liquid). Once the refrigerant has been condensed (changed) to a liquid it is cooled even further by the air that continues to flow across the condenser coil.

The PTAC design determines at exactly what point (in the condenser) the change of state (i.e. gas to a liquid) takes place. In all cases, however, the refrigerant must be totally condensed (changed) to a Liquid before leaving the condenser coil.

The refrigerant leaves the condenser Coil through the liquid line as a warm high pressure liquid. It next will pass through the refrigerant drier (if so equipped). It is the function of the drier to trap any moisture present in the system, contaminants, and large particulate matter.

The liquid refrigerant next enters the metering device. The metering device is a capillary tube. The purpose of the metering device is to "meter" (i.e. control or measure) the quantity of refrigerant entering the evaporator coil.

In the case of the capillary tube this is accomplished (by design) through size (and length) of device, and the pressure difference present across the device.

Since the evaporator coil is under a lower pressure (due to the suction created by the compressor) than the liquid line, the liquid refrigerant leaves the metering device entering the evaporator coil. As it enters the evaporator coil, the larger area and lower pressure allows the refrigerant to expand and lower its temperature (heat intensity). This expansion is often referred to as "boiling". Since the unit's blower is moving indoor air across the finned surface of the evaporator coil, the expanding refrigerant absorbs some of that heat. This results in a lowering of the indoor air temperature, hence the "cooling" effect.

The expansion and absorbing of heat cause the liquid refrigerant to evaporate (i.e. change to a gas). Once the refrigerant has been evaporated (changed to a gas), it is heated even further by the air that continues to flow across the evaporator coil.

The particular system design determines at exactly what point (in the evaporator) the change of state (i.e. liquid to a gas) takes place. In all cases, however, the refrigerant must be totally evaporated (changed) to a gas before leaving the evaporator coil.

The low pressure (suction) created by the compressor causes the refrigerant to leave the evaporator through the suction line as a cool low pressure vapor. The refrigerant then returns to the compressor, where the cycle is repeated.

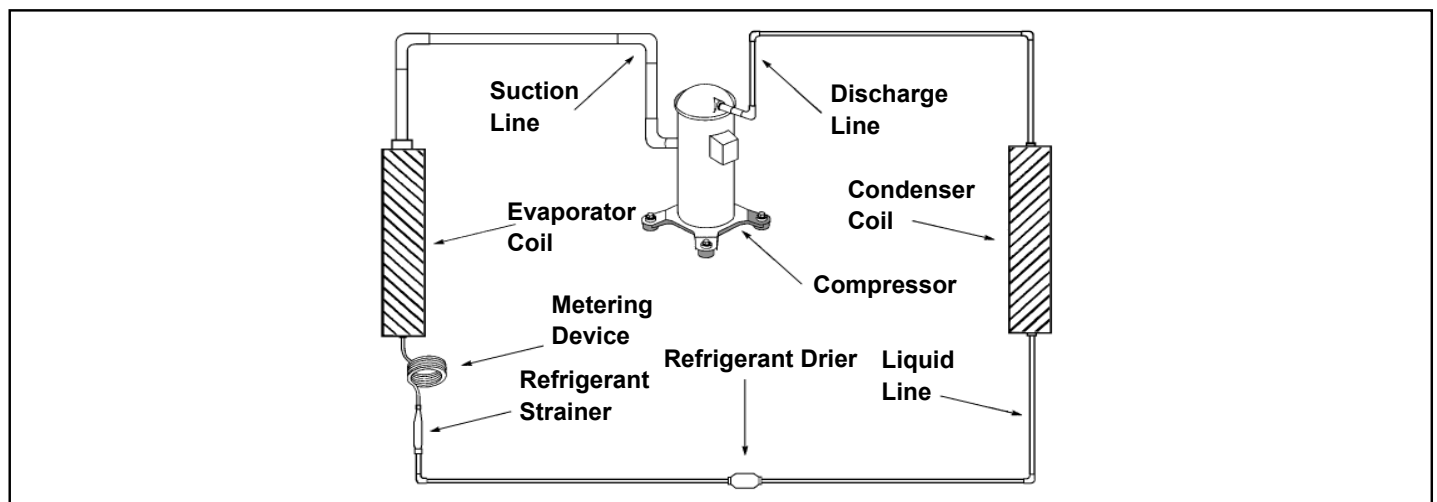

R-410A SEALED REFRIGERATION SYSTEM REPAIRS

IMPORTANT

SEALED SYSTEM REPAIRS TO COOL-ONLY MODELS REQUIRE THE INSTALLATION OF A LIQUID LINE DRIER.
SEALED SYSTEM REPAIRS TO HEAT PUMP MODELS REQUIRE THE INSTALLATION OF A SUCTION LINE DRIER.

EQUIPMENT REQUIRED:

1. Voltmeter
2. Ammeter
3. Ohmmeter
4. E.P.A. Approved Refrigerant Recovery System
5. Vacuum Pump (capable of 200 microns or less vacuum.)
6. Acetylene Welder
7. Electronic Halogen Leak Detector capable of detecting HFC (Hydrofluorocarbon) refrigerants.
8. Accurate refrigerant charge measuring device such as:
 - a. Balance Scales - 1/2 oz. accuracy
 - b. Charging Board - 1/2 oz. accuracy
9. High Pressure Gauge - (0 - 750 lbs.)
10. Low Pressure Gauge - (30 - 200 lbs.)
11. Vacuum Gauge - (0 - 1000 microns)
12. Facilities for flowing nitrogen through refrigeration tubing during all brazing processes.

EQUIPMENT MUST BE CAPABLE OF:

1. Recovering refrigerant to EPA required levels.
2. Evacuation from both the high side and low side of the system simultaneously.
3. Introducing refrigerant charge into high side of the system.
4. Accurately weighing the refrigerant charge introduced into the system.

⚠ WARNING	
	RISK OF ELECTRIC SHOCK
	Unplug and/or disconnect all electrical power to the unit before performing inspections, maintenances or service.
	Failure to do so could result in electric shock, serious injury or death.

⚠ WARNING	
	HIGH PRESSURE HAZARD
	Sealed Refrigeration System contains refrigerant and oil under high pressure.
	Proper safety procedures must be followed, and proper protective clothing must be worn when working with refrigerants. Failure to follow these procedures could result in serious injury or death.

Too much refrigerant (overcharge) in the system is just as bad (if not worse) than not enough refrigerant (undercharge). They both can be the source of certain compressor failures if they remain uncorrected for any period of time. Quite often, other problems (such as low air flow across evaporator, etc.) are misdiagnosed as refrigerant charge problems. The refrigerant circuit diagnosis chart will assist you in properly diagnosing these systems.

An overcharged unit will at times return liquid refrigerant (slugging) back to the suction side of the compressor eventually causing a mechanical failure within the compressor. This mechanical failure can manifest itself as valve failure, bearing failure, and/or other mechanical failure. The specific type of failure will be influenced by the amount of liquid being returned, and the length of time the slugging continues.

Not enough refrigerant (undercharge) on the other hand, will cause the temperature of the suction gas to increase to the point where it does not provide sufficient cooling for the compressor motor. When this occurs, the motor winding temperature will increase causing the motor to overheat and possibly cycle open the compressor overload protector. Continued overheating of the motor windings and/or cycling of the overload will eventually lead to compressor motor or overload failure.

Refrigerant Charging

Proper refrigerant charge is essential to proper unit operation. Operating a unit with an improper refrigerant charge will result in reduced performance (capacity) and/or efficiency. Accordingly, the use of proper charging methods during servicing will insure that the unit is functioning as designed and that its compressor will not be damaged.

Method Of Charging / Repairs

The acceptable method for charging the RAC system is the Weighed in Charge Method. The weighed in charge method is applicable to all units. It is the preferred method to use, as it is the most accurate.

The weighed in method should always be used whenever a charge is removed from a unit such as for a leak repair, compressor replacement, or when there is no refrigerant charge left in the unit. To charge by this method, requires the following steps:

1. Install a piercing valve to remove refrigerant from the sealed system. (Piercing valve must be removed from the system before recharging.)
2. Recover Refrigerant in accordance with EPA regulations.

⚠ WARNING	
	<p>BURN HAZARD</p> <p>Proper safety procedures must be followed, and proper protective clothing must be worn when working with a torch.</p> <p>Failure to follow these procedures could result in moderate or serious injury.</p>

3. Install a process tube to sealed system.

⚠ CAUTION	
	<p>FREEZE HAZARD</p> <p>Proper safety procedures must be followed, and proper protective clothing must be worn when working with liquid refrigerant.</p> <p>Failure to follow these procedures could result in minor to moderate injury.</p>

4. Make necessary repairs to system.
5. Evacuate system to 200 microns or less.
6. Weigh in refrigerant with the property quantity of R-410A refrigerant.
7. Start unit, and verify performance.

⚠ WARNING	
	<p>BURN HAZARD</p> <p>Proper safety procedures must be followed, and proper protective clothing must be worn when working with a torch.</p> <p>Failure to follow these procedures could result in moderate or serious injury.</p>

8. Crimp the process tube and solder the end shut.

⚠ WARNING	
	<p>ELECTRIC SHOCK HAZARD</p> <p>Turn off electric power before service or installation.</p> <p>Extreme care must be used, if it becomes necessary to work on equipment with power applied.</p> <p>Failure to do so could result in serious injury or death.</p>

⚠ WARNING	
	<p>HIGH PRESSURE HAZARD</p> <p>Sealed Refrigeration System contains refrigerant and oil under high pressure.</p> <p>Proper safety procedures must be followed, and proper protective clothing must be worn when working with refrigerants.</p> <p>Failure to follow these procedures could result in serious injury or death.</p>

Undercharged Refrigerant Systems

An undercharged system will result in poor performance (low pressures, etc.) in both the heating and cooling cycle.

Whenever you service a unit with an undercharge of refrigerant, always suspect a leak. The leak must be repaired before charging the unit.

To check for an undercharged system, turn the unit on, allow the compressor to run long enough to establish working pressures in the system (15 to 20 minutes).

During the cooling cycle you can listen carefully at the exit of the metering device into the evaporator; an intermittent hissing and gurgling sound indicates a low refrigerant charge. Intermittent frosting and thawing of the evaporator is another indication of a low charge, however, frosting and thawing can also be caused by insufficient air over the evaporator.

Checks for an undercharged system can be made at the compressor. If the compressor seems quieter than normal, it is an indication of a low refrigerant charge.

A check of the amperage drawn by the compressor motor should show a lower reading. (Check the Unit Specification.)

After the unit has run 10 to 15 minutes, check the gauge pressures. Gauges connected to system with an undercharge will have low head pressures and substantially low suction pressures.

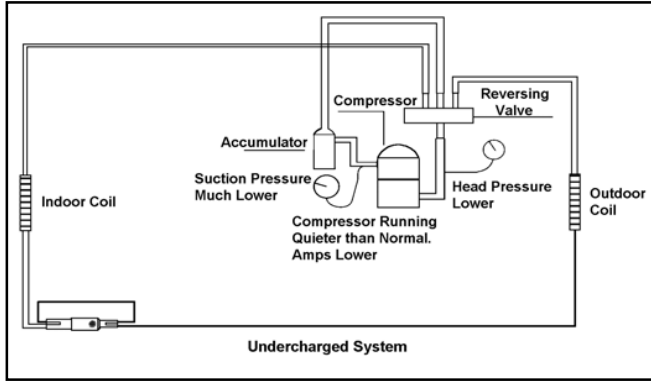

Overcharged Refrigerant Systems

Compressor amps will be near normal or higher. Noncondensables can also cause these symptoms. To confirm, remove some of the charge, if conditions improve, system may be overcharged. If conditions don't improve, Noncondensables are indicated.

Whenever an overcharged system is indicated, always make sure that the problem is not caused by air flow problems.

Improper air flow over the evaporator coil may indicate some of the same symptoms as an over charged system. An overcharge can cause the compressor to fail, since it would be "slugged" with liquid refrigerant.

The charge for any system is critical. When the compressor is noisy, suspect an overcharge, when you are sure that the air quantity over the evaporator coil is correct. Icing of the evaporator will not be encountered because the refrigerant will boil later if at all. Gauges connected to system will usually have higher head pressure (depending upon amount of over charge). Suction pressure should be slightly higher.

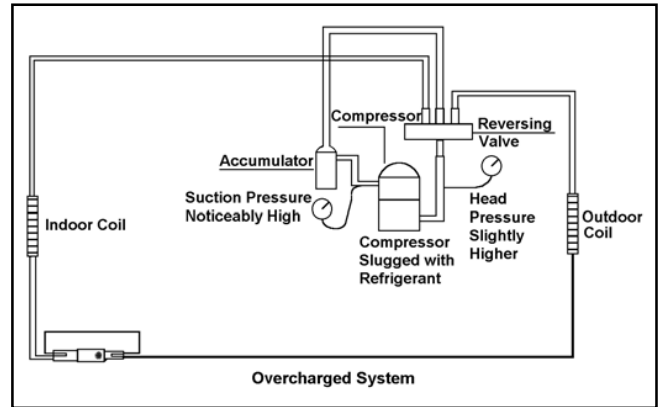

Restricted Refrigerant System

Troubleshooting a restricted refrigerant system can be difficult. The following procedures are the more common problems and solutions to these problems. There are two types of refrigerant restrictions: Partial restrictions and complete restrictions.

A partial restriction allows some of the refrigerant to circulate through the system.

With a complete restriction there is no circulation of refrigerant in the system.

Restricted refrigerant systems display the same symptoms as a "low-charge condition."

When the unit is shut off, the gauges may equalize very slowly.

Gauges connected to a completely restricted system will run in a deep vacuum. When the unit is shut off, the gauges will not equalize at all.

A quick check for either condition begins at the evaporator. With a partial restriction, there may be gurgling sounds at the metering device entrance to the evaporator. The evaporator in a partial restriction could be partially frosted or have an ice ball close to the entrance of the metering device. Frost may continue on the suction line back to the compressor.

Often a partial restriction of any type can be found by feel, as there is a temperature difference from one side of the restriction to the other.

With a complete restriction, there will be no sound at the metering device entrance. An amperage check of the compressor with a partial restriction may show normal current when compared to the unit specification.

With a complete restriction the current drawn may be considerably less than normal, as the compressor is running in a deep vacuum (no load.) Much of the area of the condenser will be relatively cool since most or all of the liquid refrigerant will be stored there.

The following conditions are based primarily on a system in the cooling mode.

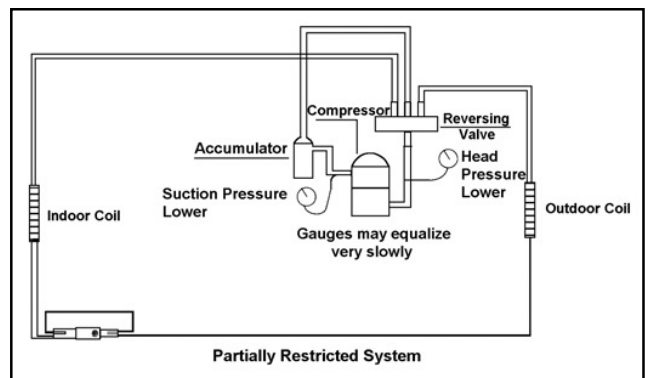
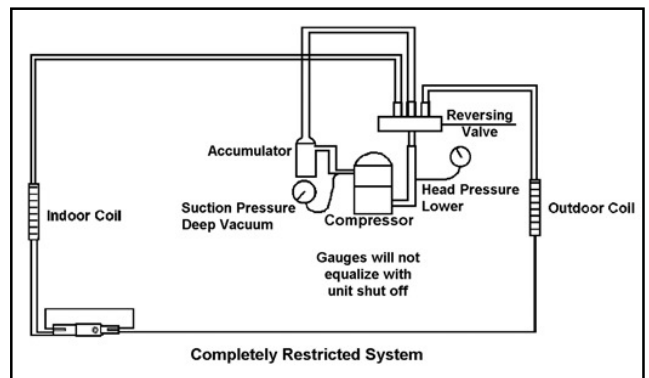

HERMETIC COMPONENTS CHECK

⚠ WARNING	
	BURN HAZARD Proper safety procedures must be followed, and proper protective clothing must be worn when working with a torch. Failure to follow these procedures could result in moderate or serious injury.

⚠ WARNING	
	CUT/SEVER HAZARD Be careful with the sharp edges and corners. Wear protective clothing and gloves, etc. Failure to do so could result in serious injury.

METERING DEVICE

Capillary Tube Systems

All units are equipped with capillary tube metering devices.

Checking for restricted capillary tubes.

1. Connect pressure gauges to unit.
2. Start the unit in the cooling mode. If after a few minutes of operation the pressures are normal, the check valve and the cooling capillary are not restricted.
3. Switch the unit to the heating mode and observe the gauge readings after a few minutes running time. If the system pressure is lower than normal, the heating capillary is restricted.
4. If the operating pressures are lower than normal in both the heating and cooling mode, the cooling capillary is restricted.

CHECK VALVE

A unique two-way check valve is used on the reverse cycle heat pumps. It is pressure operated and used to direct the flow of refrigerant through a single filter drier and to the proper capillary tube during either the heating or cooling cycle.

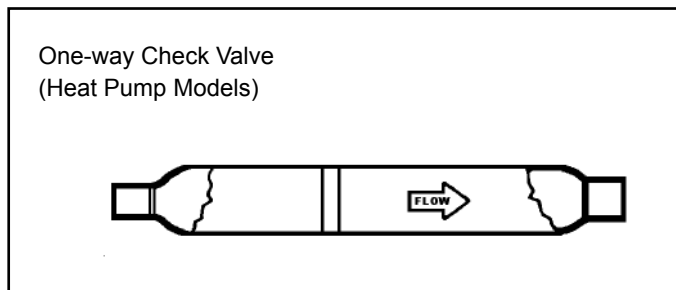

NOTE: The slide (check) inside the valve is made of teflon. Should it become necessary to replace the check valve, place a wet cloth around the valve to prevent overheating during the brazing operation.

CHECK VALVE OPERATION

In the cooling mode of operation, high pressure liquid enters the check valve forcing the slide to close the opposite port (liquid line) to the indoor coil. Refer to refrigerant flow chart. This directs the refrigerant through the filter drier and cooling capillary tube to the indoor coil.

In the heating mode of operation, high pressure refrigerant enters the check valve from the opposite direction, closing

the port (liquid line) to the outdoor coil. The flow path of the refrigerant is then through the filter drier and heating capillary to the outdoor coil.

Failure of the slide in the check valve to seat properly in either mode of operation will cause flooding of the cooling coil. This is due to the refrigerant bypassing the heating or cooling capillary tube and entering the liquid line.

COOLING MODE

In the cooling mode of operation, liquid refrigerant from condenser (liquid line) enters the cooling check valve forcing the heating check valve shut. The liquid refrigerant is directed into the liquid dryer after which the refrigerant is metered through cooling capillary tubes to evaporator. (Note: liquid refrigerant will also be directed through the heating capillary tubes in a continuous loop during the cooling mode).

HEATING MODE

In the heating mode of operation, liquid refrigerant from the indoor coil enters the heating check valve forcing the cooling check valve shut. The liquid refrigerant is directed into the liquid dryer after which the refrigerant is metered through the heating capillary tubes to outdoor coils. (Note: liquid refrigerant will also be directed through the cooling capillary tubes in a continuous loop during the heating mode).

REVERSING VALVE DESCRIPTION/OPERATION

⚠ WARNING



ELECTRIC SHOCK HAZARD

Disconnect power to the unit before servicing. Failure to follow this warning could result in serious injury or death.

The Reversing Valve controls the direction of refrigerant flow to the indoor and outdoor coils. It consists of a pressure-operated, main valve and a pilot valve actuated by a solenoid plunger. The solenoid is energized during the heating cycle only. The reversing valves used in the PTAC system is a 2-position, 4-way valve.

The single tube on one side of the main valve body is the high-pressure inlet to the valve from the compressor. The center tube on the opposite side is connected to the low pressure (suction) side of the system. The other two are connected to the indoor and outdoor coils. Small capillary tubes connect each end of the main valve cylinder to the "A" and "B" ports of the pilot valve. A third capillary is a common return line from these ports to the suction tube on the main valve body. Four-way reversing valves also have a capillary tube from the compressor discharge tube to the pilot valve.

The piston assembly in the main valve can only be shifted by the pressure differential between the high and low sides

of the system. The pilot section of the valve opens and closes ports for the small capillary tubes to the main valve to cause it to shift.

NOTE: System operating pressures must be near normal before valve can shift.

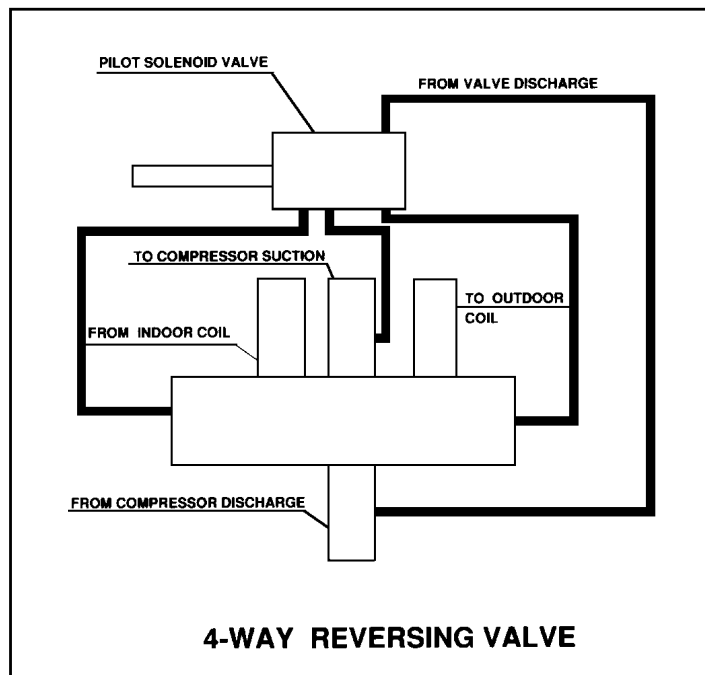

TESTING THE COIL

⚠ WARNING



ELECTRIC SHOCK HAZARD

Unplug and/or disconnect all electrical power to the unit before performing inspections, maintenances or service.

Failure to do so could result in electric shock, serious injury or death.

The solenoid coil is an electromagnetic type coil mounted on the reversing valve and is energized during the operation of the compressor in the heating cycle.

1. Turn off high voltage electrical power to unit.
2. Unplug line voltage lead from reversing valve coil.
3. Check for electrical continuity through the coil. If you do not have continuity replace the coil.
4. Check from each lead of coil to the copper liquid line as it leaves the unit or the ground lug. There should be no continuity between either of the coil leads and ground; if there is, coil is grounded and must be replaced.
5. If coil tests okay, reconnect the electrical leads.
6. Make sure coil has been assembled correctly.

NOTE: Do not start unit with solenoid coil removed from valve, or do not remove coil after unit is in operation. This will cause the coil to burn out.

CHECKING THE REVERSING VALVE

NOTE: You must have normal operating pressures before the reversing valve can shift.

⚠ WARNING

HIGH PRESSURE HAZARD

Sealed Refrigeration System contains refrigerant and oil under high pressure.



Proper safety procedures must be followed, and proper protective clothing must be worn when working with refrigerants.

Failure to follow these procedures could result in serious injury or death.

Check the operation of the valve by starting the system and switching the operation from "Cooling" to "Heating" and then back to "Cooling". Do not hammer on valve.

Occasionally, the reversing valve may stick in the heating or cooling position or in the mid-position.

When sluggish or stuck in the mid-position, part of the discharge gas from the compressor is directed back to the suction side, resulting in excessively high suction pressure.

Should the valve fail to shift from cooling to heating, block the air flow through the outdoor coil and allow the discharge pressure to build in the system. Then switch the system from heating to cooling.

If the valve is stuck in the heating position, block the air flow through the indoor coil and allow discharge pressure to build in the system. Then switch the system from heating to cooling.

Should the valve fail to shift in either position after increasing the discharge pressure, replace the valve.

Dented or damaged valve body or capillary tubes can prevent the main slide in the valve body from shifting.

If you determine this is the problem, replace the reversing valve.

After all of the previous inspections and checks have been made and determined correct, then perform the "Touch Test" on the reversing valve.

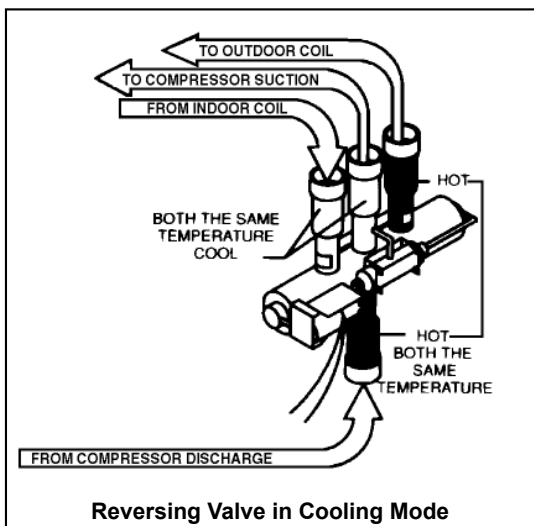
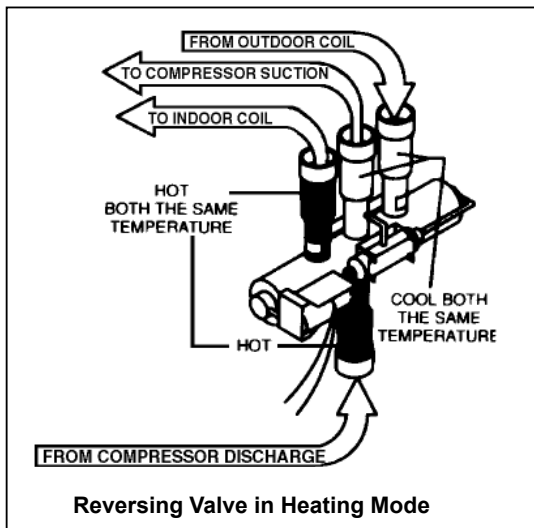

Touch Test in Heating/Cooling Cycle

⚠ WARNING	
	<p>BURN HAZARD</p> <p>Certain unit components operate at temperatures hot enough to cause burns.</p>
	<p>Proper safety procedures must be followed, and proper protective clothing must be worn.</p>
	<p>Failure to follow these procedures could result in minor to moderate injury.</p>

The only definite indications that the slide is in the mid-position is if all three tubes on the suction side of the valve are hot after a few minutes of running time.

NOTE: A condition other than those illustrated above, and on Page 31, indicate that the reversing valve is not shifting properly. Both tubes shown as hot or cool must be the same corresponding temperature.

Procedure For Changing Reversing Valve

⚠ WARNING	
	<p>HIGH PRESSURE HAZARD</p> <p>Sealed Refrigeration System contains refrigerant and oil under high pressure.</p>
	<p>Proper safety procedures must be followed, and proper protective clothing must be worn when working with refrigerants.</p>
	<p>Failure to follow these procedures could result in serious injury or death.</p>

NOTICE	
<p>FIRE HAZARD</p>	
<p>The use of a torch requires extreme care and proper judgment. Follow all safety recommended precautions and protect surrounding areas with fire proof materials. Have a fire extinguisher readily available. Failure to follow this notice could result in moderate to serious property damage.</p>	

1. Install Process Tubes. Recover refrigerant from sealed system. PROPER HANDLING OF RECOVERED REFRIGERANT ACCORDING TO EPA REGULATIONS IS REQUIRED.
2. Remove solenoid coil from reversing valve. If coil is to be reused, protect from heat while changing valve.
3. Unbrazed all lines from reversing valve.
4. Clean all excess brazed from all tubing so that they will slip into fittings on new valve.
5. Remove solenoid coil from new valve.

6. Protect new valve body from heat while brazing with plastic heat sink (Thermo Trap) or wrap valve body with wet rag.
7. Fit all lines into new valve and braze lines into new valve.

⚠ WARNING	
	<p>EXPLOSION HAZARD</p> <p>The use of nitrogen requires a pressure regulator. Follow all safety procedures and wear protective safety clothing etc.</p> <p>Failure to follow proper safety procedures could result in serious injury or death.</p>

8. Pressurize sealed system with a combination of R-22 and nitrogen and check for leaks, using a suitable leak detector. Recover refrigerant per EPA guidelines.
9. Once the sealed system is leak free, install solenoid coil on new valve and charge the sealed system by weighing in the proper amount and type of refrigerant as shown on rating plate. Crimp the process tubes and solder the ends shut. Do not leave Schrader or piercing valves in the sealed system.

NOTE: When brazing a reversing valve into the system, it is of extreme importance that the temperature of the valve does not exceed 250°F at any time.

Wrap the reversing valve with a large rag saturated with water. "Re-wet" the rag and thoroughly cool the valve after each brazing operation of the four joints involved.

The wet rag around the reversing valve will eliminate conduction of heat to the valve body when brazing the line connection.

COMPRESSOR CHECKS

⚠ WARNING	
	<p>ELECTRIC SHOCK HAZARD</p> <p>Turn off electric power before service or installation. Extreme care must be used, if it becomes necessary to work on equipment with power applied.</p> <p>Failure to do so could result in serious injury or death.</p>

Locked Rotor Voltage (L.R.V.) Test

Locked rotor voltage (L.R.V.) is the actual voltage available at the compressor under a stalled condition.

Single Phase Connections

Disconnect power from unit. Using a voltmeter, attach one lead of the meter to the run "R" terminal on the compressor and the other lead to the common "C" terminal of the compressor. Restore power to unit.

Determine L.R.V.

Start the compressor with the volt meter attached; then stop the unit. Attempt to restart the compressor within a couple of seconds and immediately read the voltage on the meter. The compressor under these conditions will not start and will usually kick out on overload within a few seconds since the pressures in the system will not have had time to equalize. Voltage should be at or above minimum voltage of 197 VAC, as specified on the rating plate. If less than minimum, check for cause of inadequate power supply; i.e., incorrect wire size, loose electrical connections, etc.

Amperage (L.R.A.) Test

The running amperage of the compressor is the most important of these readings. A running amperage higher than that indicated in the performance data indicates that a problem exists mechanically or electrically.

Single Phase Running and L.R.A. Test

NOTE: Consult the specification and performance section for running amperage. The L.R.A. can also be found on the rating plate.

Select the proper amperage scale and clamp the meter probe around the wire to the "C" terminal of the compressor.

Turn on the unit and read the running amperage on the meter. If the compressor does not start, the reading will indicate the locked rotor amperage (L.R.A.).

Overloads

The compressor is equipped with an external overload which senses both motor amperage and winding temperature. High motor temperature or amperage heats the overload causing it to open, breaking the common circuit within the compressor.

Heat generated within the compressor shell, usually due to recycling of the motor, is slow to dissipate. It may take anywhere from a few minutes to several hours for the overload to reset.

Checking the Overload

⚠ WARNING	
	<p>ELECTRIC SHOCK HAZARD</p> <p>Turn off electric power before service or installation. Extreme care must be used, if it becomes necessary to work on equipment with power applied.</p> <p>Failure to do so could result in serious injury or death.</p>

⚠ WARNING



BURN HAZARD

Certain unit components operate at temperatures hot enough to cause burns.

Proper safety procedures must be followed, and proper protective clothing must be worn.

Failure to follow this warning could result in moderate to serious injury.

External Overload

With power off, remove the leads from compressor terminals. If the compressor is hot, allow the overload to cool before starting check. Using an ohmmeter, test continuity across the terminals of the external overload. If you do not have continuity; this indicates that the overload is open and must be replaced.

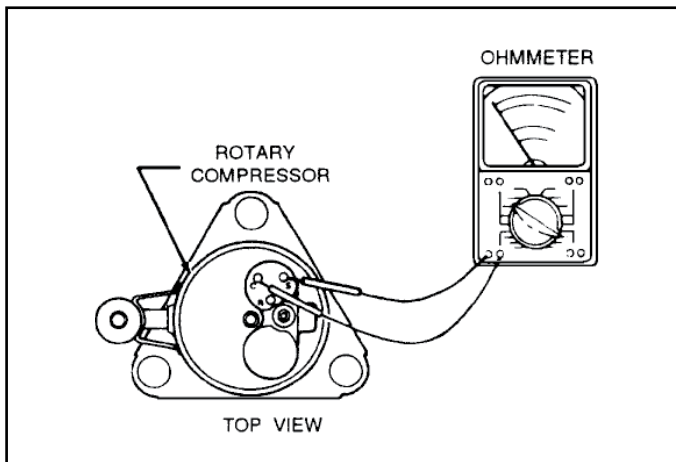

Single Phase Resistance Test

⚠ WARNING



ELECTRIC SHOCK HAZARD

Turn off electric power before service or installation. Extreme care must be used, if it becomes necessary to work on equipment with power applied.

Failure to do so could result in serious injury or death.

Remove the leads from the compressor terminals and set the ohmmeter on the lowest scale (R x 1).

Touch the leads of the ohmmeter from terminals common to start ("C" to "S"). Next, touch the leads of the ohmmeter from terminals common to run ("C" to "R").

Add values "C" to "S" and "C" to "R" together and check resistance from start to run terminals ("S" to "R"). Resistance "S" to "R" should equal the total of "C" to "S" and "C" to "R."

In a single phase PSC compressor motor, the highest value will be from the start to the run connections ("S" to "R"). The next highest resistance is from the start to the common connections ("S" to "C"). The lowest resistance is from the run to common. ("C" to "R") Before replacing a compressor, check to be sure it is defective.

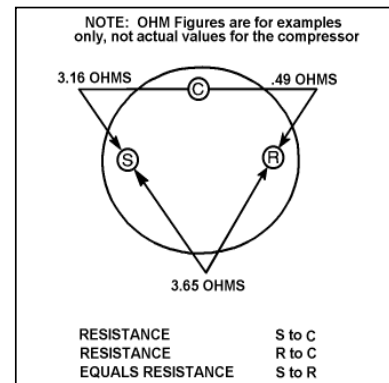

GROUND TEST

Use an ohmmeter set on its highest scale. Touch one lead to the compressor body (clean point of contact as a good connection is a must) and the other probe in turn to each compressor terminal. If a reading is obtained the compressor is grounded and must be replaced.

Check the complete electrical system to the compressor and compressor internal electrical system, check to be certain that compressor is not out on internal overload.

Complete evaluation of the system must be made whenever you suspect the compressor is defective. If the compressor has been operating for sometime, a careful examination must be made to determine why the compressor failed.

Many compressor failures are caused by the following conditions:

1. Improper air flow over the evaporator.
2. Overcharged refrigerant system causing liquid to be returned to the compressor.
3. Restricted refrigerant system.
4. Lack of lubrication.
5. Liquid refrigerant returning to compressor causing oil to be washed out of bearings.
6. Noncondensables such as air and moisture in the system. Moisture is extremely destructive to a refrigerant system.

COMPRESSOR REPLACEMENT

Recommended procedure for compressor replacement

⚠ WARNING	
	<p>RISK OF ELECTRIC SHOCK Unplug and/or disconnect all electrical power to the unit before performing inspections, maintenances or service.</p> <p>Failure to do so could result in electric shock, serious injury or death.</p>

1. Be certain to perform all necessary electrical and refrigeration tests to be sure the compressor is actually defective before replacing.

⚠ WARNING	
	<p>HIGH PRESSURE HAZARD Sealed Refrigeration System contains refrigerant and oil under high pressure.</p> <p>Proper safety procedures must be followed, and proper protective clothing must be worn when working with refrigerants.</p> <p>Failure to follow these procedures could result in serious injury or death.</p>

2. Recover all refrigerant from the system through the process tubes. **PROPER HANDLING OF RECOVERED REFRIGERANT ACCORDING TO EPA REGULATIONS IS REQUIRED.** Do not use gauge manifold for this purpose if there has been a burnout. You will contaminate your manifold and hoses. Use a Schrader valve adapter and copper tubing for burnout failures.

⚠ WARNING	
	<p>HIGH TEMPERATURES Extreme care, proper judgment and all safety procedures must be followed when testing, troubleshooting, handling or working around unit while in operation with high temperature components. Wear protective safety aids such as: gloves, clothing etc.</p> <p>Failure to do so could result in serious burn injury.</p>

NOTICE	
FIRE HAZARD	
<p>The use of a torch requires extreme care and proper judgment. Follow all safety recommended precautions and protect surrounding areas with fire proof materials. Have a fire extinguisher readily available. Failure to follow this notice could result in moderate to serious property damage.</p>	

3. After all refrigerant has been recovered, disconnect suction and discharge lines from the compressor and remove compressor. Be certain to have both suction and discharge process tubes open to atmosphere.
4. Carefully pour a small amount of oil from the suction stub of the defective compressor into a clean container.
5. Using an acid test kit (one shot or conventional kit), test the oil for acid content according to the instructions with the kit.
6. If any evidence of a burnout is found, no matter how slight, the system will need to be cleaned up following proper procedures.
7. Install the replacement compressor.

⚠ WARNING	
	<p>EXPLOSION HAZARD The use of nitrogen requires a pressure regulator. Follow all safety procedures and wear protective safety clothing etc.</p> <p>Failure to follow proper safety procedures result in serious injury or death.</p>

8. Pressurize with a combination of R-410A and nitrogen and leak test all connections with leak detector capable of detecting HFC (Hydrofluorocarbon) refrigerant. Recover refrigerant/nitrogen mixture and repair any leaks found.
Repeat Step 8 to insure no more leaks are present.
9. Evacuate the system with a good vacuum pump capable of a final vacuum of 200 microns or less. The system should be evacuated through both liquid line and suction line gauge ports. While the unit is being evacuated, seal all openings on the defective compressor.

⚠ CAUTION	
	<p>FREEZE HAZARD Proper safety procedures must be followed, and proper protective clothing must be worn when working with liquid refrigerant.</p> <p>Failure to follow these procedures could result in minor to moderate injury.</p>

10. Recharge the system with the correct amount of refrigerant. The proper refrigerant charge will be found on the unit rating plate. The use of an accurate measuring device, such as a charging cylinder, electronic scales or similar device is necessary.

NOTICE	
<p>NEVER, under any circumstances, charge a rotary compressor through the LOW side. Doing so would cause permanent damage to the new compressor.</p>	

SPECIAL PROCEDURE IN THE CASE OF MOTOR COMPRESSOR BURNOUT

⚠ WARNING	
	ELECTRIC SHOCK HAZARD Turn off electric power before service or installation. Failure to do so may result in personal injury, or death.

⚠ WARNING	
	HIGH PRESSURE HAZARD Sealed Refrigeration System contains refrigerant and oil under high pressure. Proper safety procedures must be followed, and proper protective clothing must be worn when working with refrigerants. Failure to follow these procedures could result in serious injury or death.

⚠ WARNING	
	EXPLOSION HAZARD The use of nitrogen requires a pressure regulator. Follow all safety procedures and wear protective safety clothing etc. Failure to follow proper safety procedures result in serious injury or death.

1. Recover all refrigerant and oil from the system.
2. Remove compressor, capillary tube and filter drier from the system.
3. Flush evaporator condenser and all connecting tubing with dry nitrogen or equivalent. Use approved flushing agent to remove all contamination from system. Inspect suction and discharge line for carbon deposits. Remove and clean if necessary. Ensure all acid is neutralized.
4. Reassemble the system, including new drier strainer and capillary tube.
5. Proceed with step 8-10 on previous page.

ROUTINE MAINTENANCE

⚠ WARNING	
	ELECTRICAL SHOCK HAZARD! Turn off electrical power before service or installation. All electrical connections and wiring MUST be installed by a qualified electrician and conform to the National Code and all local codes which have jurisdiction. Failure to do so can result in property damage, personal injury and/or death.

To ensure proper unit operation and life expectancy, the following maintenance procedures should be performed on a regular basis

1. Air Filter

To ensure proper unit operation, the air filters should be cleaned at least monthly, and more frequently if conditions warrant. The unit must be turned off before the filters are cleaned.

To remove the air filters, grasp the top of the filter and lift out of the front cabinet. Reverse the procedure to reinstall the filters.

Clean the filters with a mild detergent in warm water, and allow them to dry thoroughly before reinstalling.

2. Coils & Chassis

NOTE: Do not use a caustic coil cleaning agent on coils or base pan. Use a biodegradable cleaning agent and degreaser. The use of harsh cleaning materials may lead to deterioration of the aluminum fins or the coil end plates.

The indoor coil and outdoor coils and base pan should be inspected periodically (annually or semi-annually) and cleaned of all debris (lint, dirt, leaves, paper, etc.) as necessary. Under extreme conditions, more frequent cleaning may be required. Clean the coils and base pan with a soft brush and compressed air or vacuum. A pressure washer may also be used, however, you must be careful not to bend the aluminum fin pack. Use a sweeping up and down motion in the direction of the vertical aluminum fin pack when pressure cleaning coils.

Note: It is extremely important to insure that none of the electrical and/or electronic parts of the unit get wet. Be sure to cover all electrical components to protect them from water or spray.

3. Decorative Front

The decorative front and discharge air grille may be cleaned with a mild soap or detergent. Do NOT use solvents or hydrocarbon based cleaners such as acetone, naphtha, gasoline, benzene, etc., to clean the decorative front or air discharge grilles.

Use a damp (not wet) cloth when cleaning the control area to prevent water from entering the unit, and possibly damaging the electronic control

4. Fan Motor & Compressor

The fan motor & compressor are permanently lubricated, and require no additional lubrication.

5. Wall Sleeve

Inspect the inside of the wall sleeve and drain system periodically (annually or semi-annually) and clean as required. Under extreme conditions, more frequent cleaning may be necessary. Clean both of these areas with an antibacterial and antifungal cleaner. Rinse both items thoroughly with water and ensure that the drain outlets are operating properly.

TROUBLESHOOTING CHART - COOLING

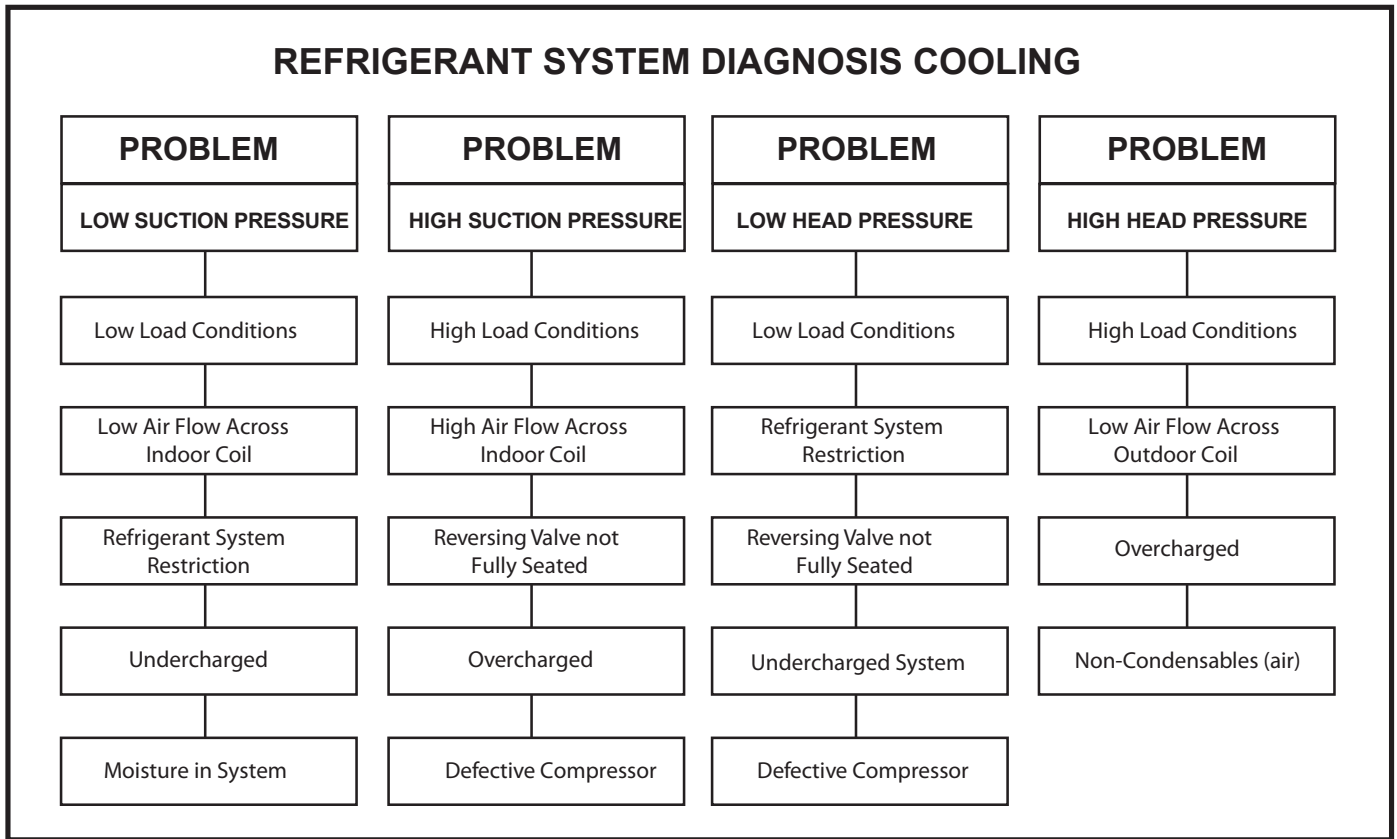

TROUBLESHOOTING CHART - HEATING

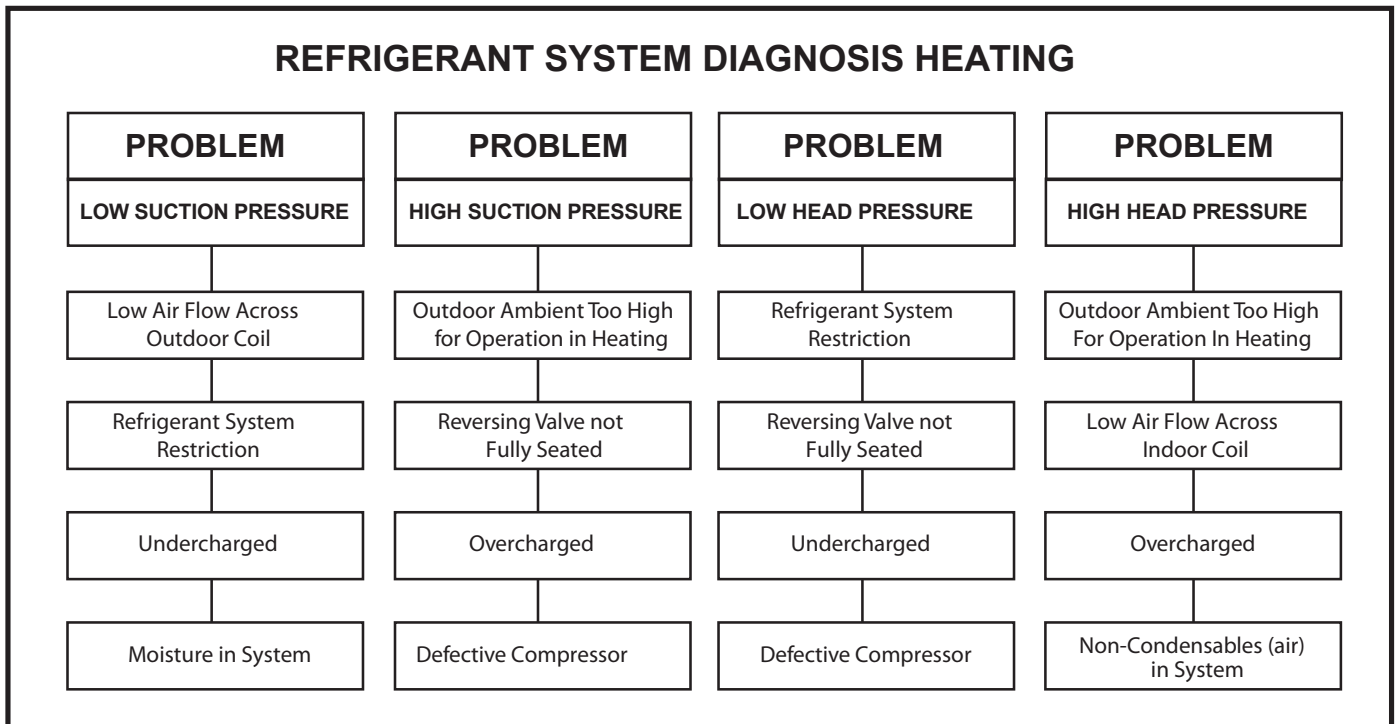

ELECTRICAL TROUBLESHOOTING CHART - HEAT PUMP

⚠ WARNING	
	<p>ELECTRIC SHOCK HAZARD Turn off electric power before service or installation.</p> <p>Extreme care must be used, if it becomes necessary to work on equipment with power applied.</p> <p>Failure to do so could result in serious injury or death.</p>

⚠ CAUTION	
	<p>BURN HAZARD Certain unit components operate at temperatures hot enough to cause burns.</p> <p>Proper safety procedures must be followed, and proper protective clothing must be worn.</p> <p>Failure to do so could result in minor to moderate injury.</p>

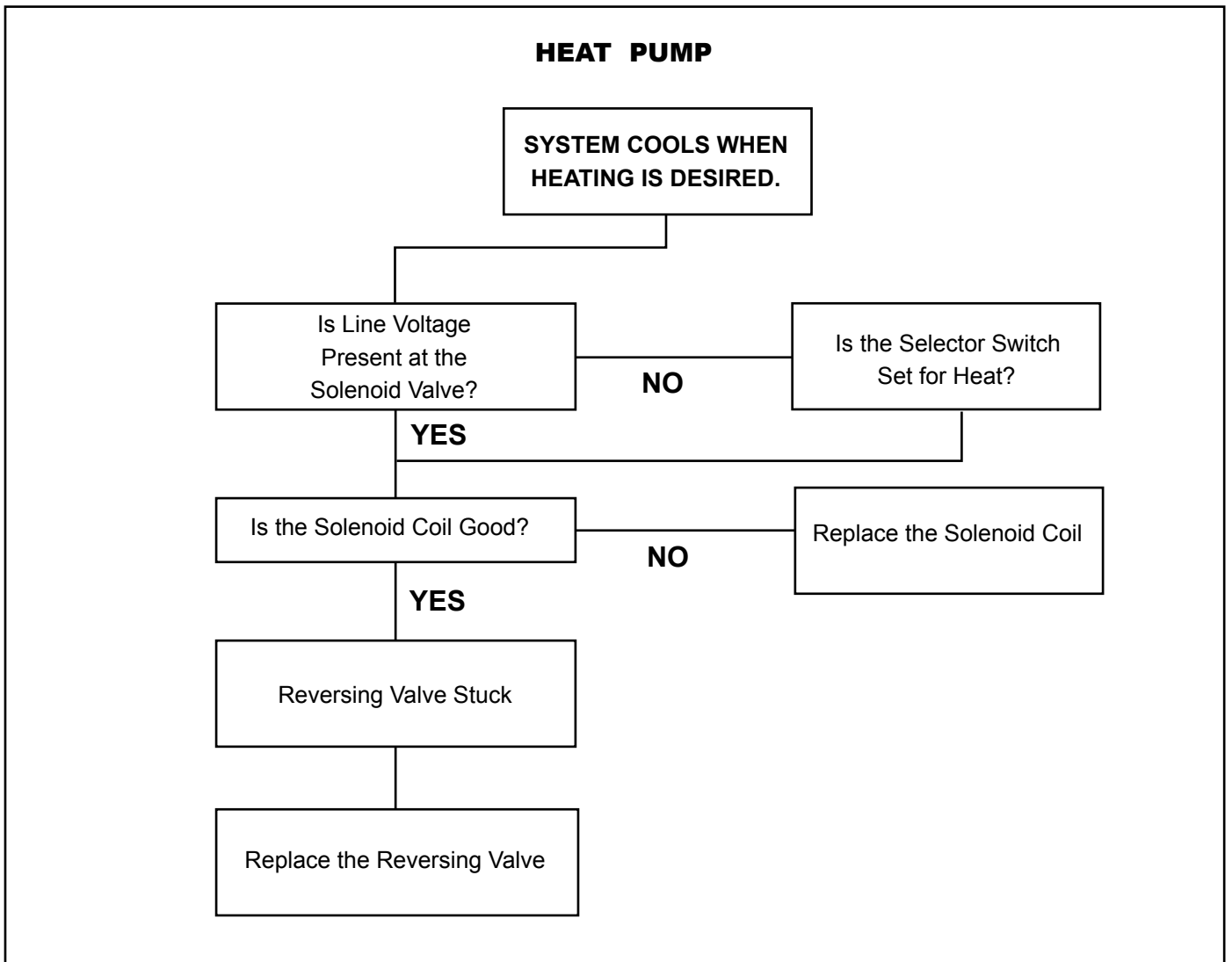

REMOTE WALL THERMOSTAT WIRING DIAGRAM COOL WITH ELECTRIC HEAT

LEGEND FOR T-STAT WIRING HARNESS

R	24 VAC Power From Unit
Y	Coil for Cooling
W	Call for Heat
O	Reversing Valve Energized in cooling mode
GL	Call for Low Fan
GH	Call for High Fan
RT6 - Two Speeds Fan T-Stat - Field Provided	
- - - - Field Wiring	

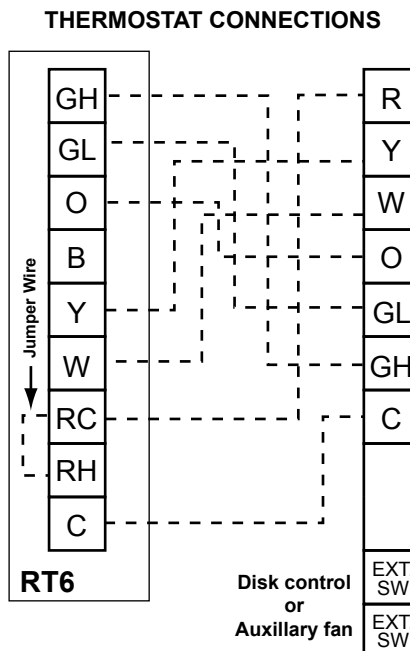

Electronic
Control
Board

REMOTE WALL THERMOSTAT WIRING DIAGRAM HEAT PUMP WITH ELECTRIC HEAT

LEGEND FOR T-STAT WIRING HARNESS

R	24 VAC Power From Unit
Y	Coil for Cooling
W	Call for Heat
O	Reversing Valve Energized in cooling mode
GL	Call for Low Fan
GH	Call for High Fan
RT6 - Two Speeds Fan T-Stat - Field Provided	
- - - - Field Wiring	

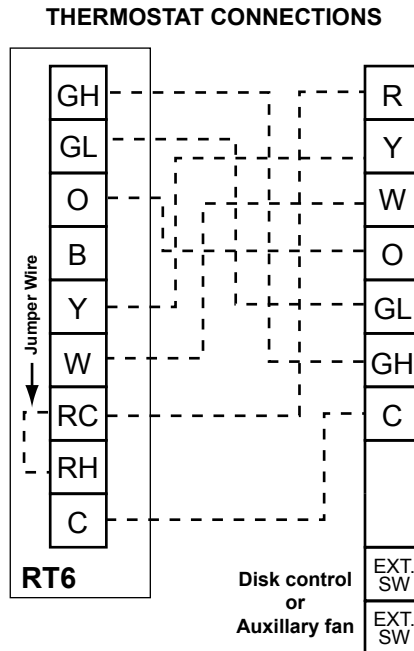

Electronic
Control
Board

WIRING DIAGRAM

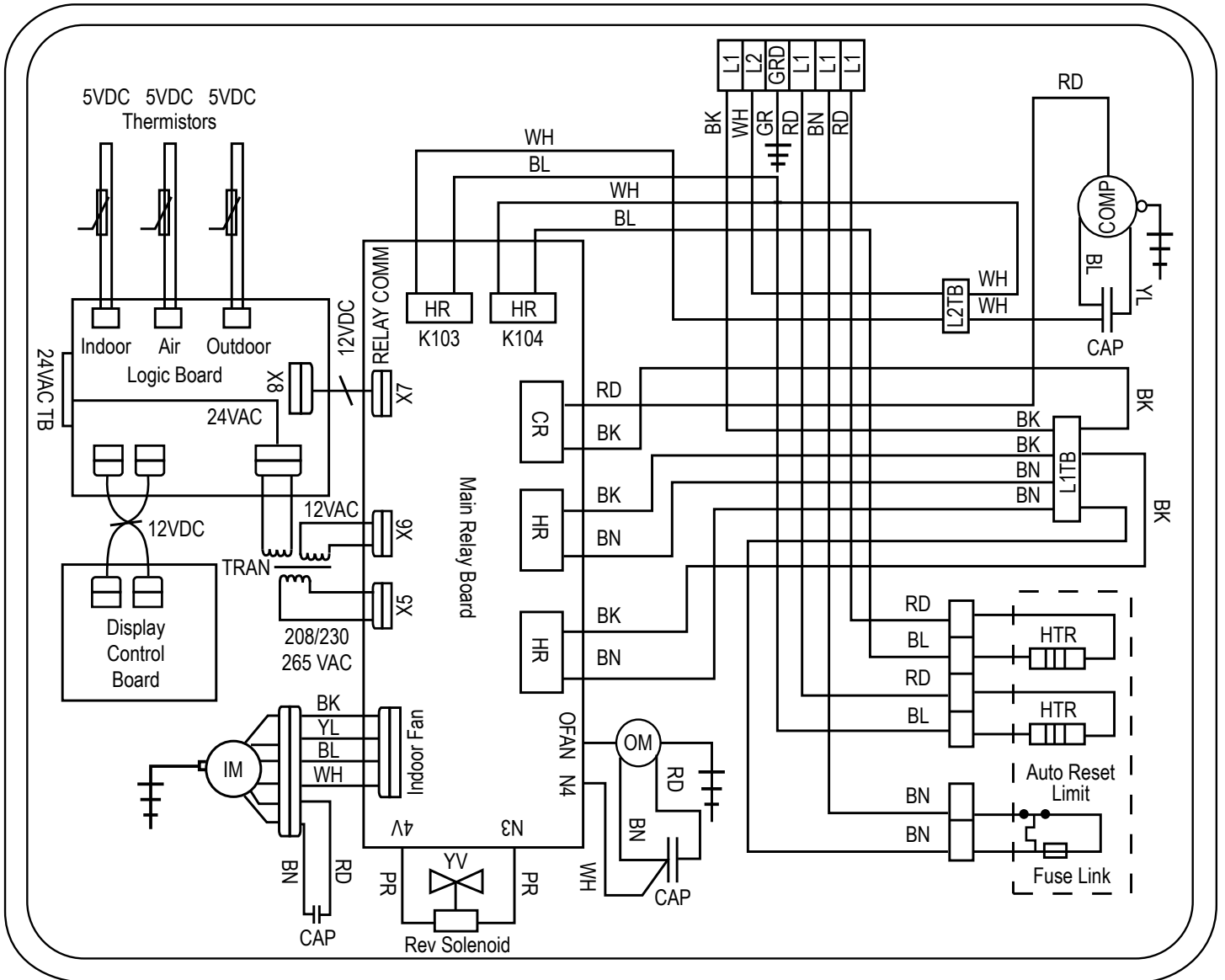

COMPONENT ID
COMP = Compressor
CAP = Capacitor
HTR = Heater
TB = Terminal Block
OM = Outdoor Fan Motor
IM = Indoor Fan Motor
TRAN = Transformer
RELAY COMM = L.V. Relay Cable
CR = Compressor Relay
HR = Heater Relay
YV = Reversing Valve Solenoid

WIRE COLOR ID
BL = Blue
BN = Brown
BK = Black
RD = Red
WH = White
PR = Purple
YL = Yellow
GR = Green



RT6

Electronic Thermostat

- 1-Stage Heat/1-Stage Cool Systems
- Configurable to: 2-stage heat pump
- Large Display With Backlight
- Selectable Fahrenheit or Celsius



Installation, Operation & Application Guide



Parts Diagram

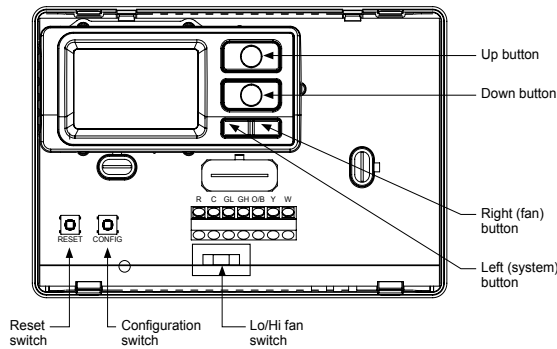

Icon Descriptions

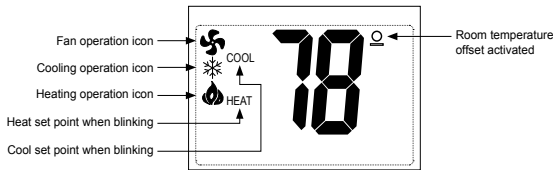

Specifications

- Electrical rating:** • 24 VAC (15-30 VAC)
• 1 amp maximum per terminal
• 3 amp maximum total load
- Temperature control range:** 45°F to 90°F (7°C to 32°C) **Accuracy:** ± 1°F (± 0.5°C)
- System configurations:** 2-stage heat, 1-stage cool, heat pump, electric
- Timing:** Anti-short Cycle: 4 minutes (bypass anti-short cycle delay by returning to OFF mode for 5 seconds)
Backlight Operation: 10 seconds
- Terminations:** R, C, GL, GH, O/B, Y, W

Important Safety Information

- WARNING!** Always turn off power at the main power supply before installing, cleaning, or removing thermostat.
- This thermostat is for 24 VAC applications only; do not use on voltages over 30 VAC
 - All wiring must conform to local and national electrical and building codes
 - Do not use air conditioning when the outdoor temperature is below 50 degrees; this can damage your A/C system and cause personal injuries
 - Use this thermostat only as described in this manual

Package Contents/Tools Required

- Package includes:** RT6 thermostat on base, thermostat cover, wiring labels, screws and wall anchors, Installation, Operation and Application Guide
- Tools required for installation:** Drill with 3/16" bit, hammer, screwdriver

To Remove Existing Thermostat

- ELECTRICAL SHOCK HAZARD – Turn off power at the main service panel by removing the fuse or switching the appropriate circuit breaker to the OFF position before removing the existing thermostat.**
1. Turn off power to the heating and cooling system by removing the fuse or switching the appropriate circuit breaker off.
 2. Remove cover of old thermostat. This should expose the wires.
 3. Label the existing wires with the enclosed wire labels before removing wires.
 4. After labeling wires, remove wires from wire terminals.
 5. Remove existing thermostat base from wall.
 6. Refer to the following section for instructions on how to install this thermostat.

To Install Thermostat

- ELECTRICAL SHOCK HAZARD – Turn off power at the main service panel by removing the fuse or switching the appropriate circuit breaker to the OFF position before removing the existing thermostat.**
- IMPORTANT:** Thermostat installation must conform to local and national building and electrical codes and ordinances.
- **Note:** Mount the thermostat about five feet above the floor. Do not mount the thermostat on an outside wall, in direct sunlight, behind a door, or in an area affected by a vent or duct.
1. Turn off power to the heating and cooling system by removing the fuse or switching the appropriate circuit breaker off.
 2. To remove cover, pull gently at the seam at the top.
 3. Put thermostat base against the wall where you plan to mount it (Be sure wires will feed through the wire opening in the base of the thermostat).
 4. Mark the placement of the mounting holes.
 5. Set thermostat base and cover away from working area.
 6. Using a 3/16" drill bit, drill holes in the places you have marked for mounting.
 7. Use a hammer to tap supplied anchors in mounting holes.
 8. Align thermostat base with mounting holes and feed the control wires through slit in thermal intrusion barrier and into wire opening.
 9. Use supplied screws to mount thermostat base to wall.
 10. Insert stripped, labeled wires in matching wire terminals.
- CAUTION!** Be sure exposed portion of wires does not touch other wires.
11. Gently tug wire to be sure of proper connection. Double check that each wire is connected to the proper terminal.
 12. Turn on power to the system at the main service panel.
 13. Configure thermostat to match the type of system you have.
 14. Replace cover on thermostat by snapping it in place.
 15. Test thermostat operation as described in "Testing the Thermostat".

Wiring Diagrams

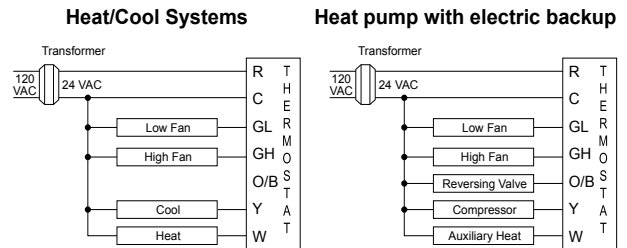

Terminal Designator Descriptions

- R – 24 VAC hot
- C – 24 VAC common
- O/B – Configurable
 - O – Cool active reversing valve (Freidrich PTHP)
 - B – Heat active reversing valve (Freidrich Vert-I-Pak, Kuhl+HP)
- Y – 1st stage cool, 1st stage heat for heat pumps
- W – 1st stage heat for non-heat pump systems, auxiliary heat for HP systems
- GL – Low fan
- GH – High fan

RT6 Output Chart

	Configuration	1 ST Cool	1 ST Heat	2 ND Heat
Heat/Cool and single stage HP models	ELC	Y, G	W, G, B	N/A
PDH (PTHP) models only	HP 'O' Config	Y, G, O	Y, G	Y, W, G

The RT6 thermostat is configurable for different systems. The configuration directly affects the outputs. Use the output chart to correctly configure and wire the thermostat to your system.

Configuration Mode

The configuration mode is used to set the RT6 to match your heating/cooling system. The RT6 functions with heat pump, air conditioning, or electric heat systems.

• **Note:** Thermostat comes configured for 1-stage heat / 1-stage cooling for use with all heat/cool and single-stage heat pump models. For Friedrich PTHP models follow the instructions below to configure the thermostat for two-stage heat pump operation using the 'O' terminal.

To configure the RT6, perform the following steps:

1. Verify the RT6 is in the OFF mode.
Press the SYS (left) button until off mode displays.
2. Remove the cover of the thermostat by gently pulling near one of the corners at the top of the thermostat.
3. Press the CONFIG button for 1 second while the RT6 is in OFF mode.



Press the up or down button to change settings within each screen.



Press the right button to advance to the next screen.
• **Note:** Pressing the left button will return you to the previous screen.

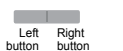

To exit configuration mode, press the CONFIG switch for 1 second.

Configuration Mode Settings

The setup screens for Configuration Mode are as follows:

1. **System** – Set for heat pump, non-heat pump, reversing valve operation

System	Setting	Reversing Valve Setting	Friedrich Models
Heat Pump	HP	O - Energized in Cooling	PDH (PTHP) Only
Heat/Cool and Single-Stage Heat Pump Only	ELC	N/A	VEA, PDE (PTAC), Kuhl+

Press the **up** or **down** button to select.
Press the **right** button to advance to the next screen.

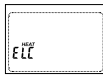

2. **Temperature Scale** (F or C)

Choose Fahrenheit or Celsius.
Press the **up** or **down** button to select.
Press the **right** button to advance to the next screen.



3. **1st Stage Temperature Differential** (1°F to 5°F) (0.5°C to 2.5°C)

Set the number of degrees between your "setpoint" temperature and your "turn on" temperature.
Press the **up** or **down** button to set differential value.
Press the **right** button to advance to the next screen.

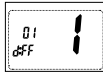

4. **2nd Stage Temperature Differential** (1°F to 5°F) (0.5°C to 2.5°C) (For HP 0 only)

Set the number of degrees between when stage 1 turns on and when stage 2 turns on.
Press the **up** or **down** button to set differential value.
Press the **right** button to advance to the next screen.



5. **Staged Off Outputs** (For HP 0 only)

Select whether the outputs for heating and cooling are staged off independently or are satisfied simultaneously.
1 = outputs staged off independently
0 = outputs off simultaneously
Press the **up** or **down** button to set.
Press the **right** button to advance to the next screen.

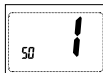

6. **Auxiliary Delay ON** – (0-30 minutes) (For HP 0 only)

Set the delay time in minutes for auxiliary heat to be locked out after a call for second stage. This extra savings feature is used to temporarily lock out auxiliary heat devices, allowing just heat pump to try to satisfy heat call.
Press the **up** or **down** button to select.
Press the **right** button to advance to the next screen.

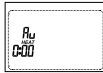

7. **Maximum Heat Setpoint** (45°F to 90°F) (7°C to 32°C)

Adjust to control the maximum heat set temperature allowed.
Press the **up** or **down** button to select.
Press the **right** button to advance to the next screen.



8. **Minimum Cool Setpoint** (45°F to 90°F) (7°C to 32°C)

Adjust to control the minimum cool set temperature allowed.
Press the **up** or **down** button to select.
Press the **right** button to advance to the next screen.

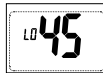

9. **Room Temperature Offset** (+9°F to -9°F) (+4.5°C to -4.5°C)

Adjust to calibrate displayed room temperature to match actual room temperature.
** Note: When not set to 0, 9 will display.
Press the **up** or **down** button to select.
Press the **right** button to advance to the next screen.

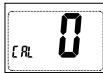

Mode of Operation

The RT6 is a 1-stage or 2-stage heat thermostat. It functions with air conditioning, heat pumps, or electric heat systems.

The thermostat activates the heating appliance when the room temperature is below the set heat temperature (by the differential temperature). The RT6 will stop outputting when the call for heat has been satisfied. With heat pumps, the thermostat will not let the compressor come on for 4 minutes after it turns off. This protects your compressor.

When the room temperature is greater than the set cool temperature (by the differential temperature), the cooling device is activated. The RT6 will stop outputting when the call for cooling is satisfied. The thermostat will not let the compressor come on for 4 minutes after it turns off. This protects your compressor.

The RT6 has three possible operating modes: **OFF**, **Heat**, and **Cool** mode. In off mode, the thermostat will not turn on heating or cooling devices. The manual fan can be turned on in all operating modes using the fan button. In heat mode, the thermostat controls the heating system. In the cool mode, the thermostat controls the cooling system.

Button Functions

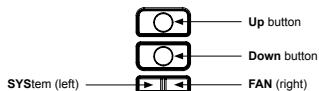

UP – Used to increase the set temperatures and to adjust configuration settings.

DOWN – Used to decrease the set temperatures and to adjust configuration settings.

SYS (left) – Used to change from OFF, HEAT, and COOL modes

FAN (right) – Used to turn on and off the indoor fan.

Operating Modes

There are four possible operating modes for the RT6. Off, Heat, and Cool modes are accessed by pressing the **SYS** (left) button.

OFF Mode

- In this mode, the thermostat will not turn on the heating or cooling devices
- ** Note: The indoor fan can be turned on manually in every operating mode by pressing the **FAN** (right) button. The word **FAN** shows on the display and the fan icon appears when the fan operates.



Heat Mode

- In this mode, the thermostat controls the heating system. When the heat outputs, the flame icon appears on the display.
- ** Note: For heat pumps, there is a four minute delay for your compressor to restart after it has turned off. To bypass the compressor time delay, go to OFF mode for 5 seconds.

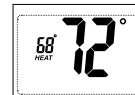

Cool Mode

- In this mode, the thermostat controls the cooling system. When the cooling outputs, the snowflake icon appears on the display.
- ** Note: There is a four minute delay for your compressor to restart after it has turned off. To bypass the compressor time delay, go to OFF mode for 5 seconds.



Set Point Adjustment

Heat Set Point

- Use the **SYS** button to select Heat Mode. Press the up or down button to view the current heat set point larger on the display. When the large set point is displayed, the **HEAT** icon will blink. The up or down buttons can be used to adjust the set point. After 5 seconds of inactivity the screen will display the room temperature and the **HEAT** icon will not blink.

HEAT icon will blink.

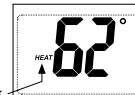

Cool Set Point

- Use the **SYS** button to select Cool Mode. Press the up or down button to view the current cool set point larger on the display. When the large set point is displayed, the **COOL** icon will blink. The up or down buttons can be used to adjust the set point. After 5 seconds of inactivity the screen will display the room temperature and the **COOL** icon will not blink.

COOL icon will blink.

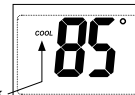

Testing the Thermostat

Once the thermostat is configured, it should be thoroughly tested.

CAUTION! Do not energize the air conditioning system when the outdoor temperature is below 50 degrees. It can result in equipment damage or personal injury.

Heat Test

- Press **SYS** (left) button until heat mode is displayed.
- Adjust the set temperature so it is 5 degrees above the room temperature.
- Heat should come on within a few seconds.
- Adjust the set temperature 2 degrees below the room temperature and the heat should turn off. There may be a fan delay on your system.
- ** Note: For heat pumps, there is a four-minute delay to protect your compressor after it turns off. To bypass the compressor time delay, go to OFF mode for 5 seconds.



Cool Test

- Press **SYS** (left) button until cool mode is displayed.
- Adjust set temperature so it is 5 degrees below room temperature.
- A/C should come on within a few seconds.
- Adjust the set temperature 2 degrees above the room temperature and the A/C should turn off. There may be a fan delay on your system.
- ** Note: There is a four-minute time delay to protect the compressor after it . To bypass the compressor time delay, go to OFF mode for 5 seconds.



Fan Test

- Press **FAN** (right) button. Fan displays. Indoor fan turns ON.
- Press **FAN** (right) button. Indoor fan turns OFF.



Troubleshooting

Symptom	Remedy
No display	Check for 24 VAC at thermostat; display is blank when 24 VAC is not present
All thermostat buttons are inoperative	Verify 24 VAC is present; unit locks out when 24 VAC is not present
No response with first button press	First button press activates backlight only
Thermostat turns on and off too frequently	Adjust temperature differential (see Configuration Mode Settings 3 & 4)
Fan runs continuously	Press FAN (right) button to turn fan off
Room temperature is not correct	Calibrate thermostat (see Configuration Mode Setting 10)
Heat or Cool not coming on	Verify wiring is correct. gently pull on each wire to verify there is a good connection at terminal block
HEAT blinking	In heat set point screen
COOL blinking	In cool set point screen
Problem not listed above	Press Reset button once*

* **Reset Button Function:** Display is refreshed, configuration settings are unchanged.



Friedrich Air Conditioning Co.

Post Office Box 1540 • San Antonio, Texas 78295-1540

4200 N. Pan Am Expressway • San Antonio, Texas 78218-5212

(210) 357-4400 • FAX (210) 357-4480

www.friedrich.com

LIAF126

Resistance Table for Air Indoor Temperature Sensor

Temp. (F)	Resistance (kΩ)	Temp. (F)	Resistance (kΩ)	Temp. (F)	Resistance (kΩ)	Temp. (F)	Resistance (kΩ)
-19	138.100	20	18.750	59	3.848	98	1.071
-18	128.600	21	17.930	60	3.711	99	1.039
-17	121.600	22	17.140	61	3.579	100	1.009
-16	115.000	23	16.390	62	3.454	101	0.980
-15	108.700	24	15.680	63	3.333	102	0.952
-14	102.900	25	15.000	64	3.217	103	0.925
-13	97.400	26	14.360	65	3.105	104	0.898
-12	92.220	27	13.740	66	2.998	105	0.873
-11	87.350	28	13.160	67	2.896	106	0.848
-10	82.750	29	12.600	68	2.797	107	0.825
-9	78.430	30	12.070	69	2.702	108	0.802
-8	74.350	31	11.570	70	2.611	109	0.779
-7	70.500	32	11.090	71	2.523	110	0.758
-6	66.880	33	10.630	72	2.439	111	0.737
-5	63.460	34	10.200	73	2.358	112	0.717
-4	60.230	35	9.779	74	2.280	113	0.697
-3	57.180	36	9.382	75	2.206	114	0.678
-2	54.310	37	9.003	76	2.133	115	0.660
-1	51.590	38	8.642	77	2.064	116	0.642
0	49.020	39	8.297	78	1.997	117	0.625
1	46.600	40	7.967	79	1.933	118	0.608
2	44.310	41	7.653	80	1.871	119	0.592
3	42.140	42	7.352	81	1.811	120	0.577
4	40.090	43	7.065	82	1.754	121	0.561
5	38.150	44	6.791	83	1.699	122	0.547
6	36.320	45	6.529	84	1.645	123	0.532
7	34.580	46	6.278	85	1.594	124	0.519
8	32.940	47	6.038	86	1.544	125	0.505
9	31.380	48	5.809	87	1.497	126	0.492
10	29.900	49	5.589	88	1.451	127	0.480
11	28.510	50	5.379	89	1.408	128	0.467
12	27.180	51	5.197	90	1.363	129	0.456
13	25.920	52	4.986	91	1.322	130	0.444
14	24.730	53	4.802	92	1.282	131	0.433
15	23.600	54	4.625	93	1.244	132	0.422
16	22.530	55	4.456	94	1.207	133	0.412
17	21.510	56	4.294	95	1.171	134	0.401
18	20.540	57	4.139	96	1.136	135	0.391
19	19.630	58	3.990	97	1.103	136	0.382

Resistance Table for Frost Protection Indoor and Outdoor Temperature Sensors

Temp. (F)	Resistance (kΩ)	Temp. (F)	Resistance (kΩ)	Temp. (F)	Resistance (kΩ)	Temp. (F)	Resistance (kΩ)
-19	181.400	20	25.010	59	5.130	98	1.427
-18	171.400	21	23.900	60	4.948	99	1.386
-17	162.100	22	22.850	61	4.773	100	1.346
-16	153.300	23	21.850	62	4.605	101	1.307
-15	145.000	24	20.900	63	4.443	102	1.269
-14	137.200	25	20.000	64	4.289	103	1.233
-13	129.900	26	19.140	65	4.140	104	1.198
-12	123.000	27	18.130	66	3.998	105	1.164
-11	116.500	28	17.550	67	3.861	106	1.131
-10	110.300	29	16.800	68	3.729	107	1.099
-9	104.600	30	16.100	69	3.603	108	1.069
-8	99.130	31	15.430	70	3.481	109	1.039
-7	94.000	32	14.790	71	3.364	110	1.010
-6	89.170	33	14.180	72	3.252	111	0.983
-5	84.610	34	13.590	73	3.144	112	0.956
-4	80.310	35	13.040	74	3.040	113	0.930
-3	76.240	36	12.510	75	2.940	114	0.904
-2	72.410	37	12.000	76	2.844	115	0.880
-1	68.790	38	11.520	77	2.752	116	0.856
0	65.370	39	11.060	78	2.663	117	0.833
1	62.130	40	10.620	79	2.577	118	0.811
2	59.080	41	10.200	80	2.495	119	0.770
3	56.190	42	9.803	81	2.415	120	0.769
4	53.460	43	9.420	82	2.339	121	0.746
5	50.870	44	9.054	83	2.265	122	0.729
6	48.420	45	8.705	84	2.194	123	0.710
7	46.110	46	8.370	85	2.125	124	0.692
8	43.920	47	8.051	86	2.059	125	0.674
9	41.840	48	7.745	87	1.996	126	0.658
10	39.870	49	7.453	88	1.934	127	0.640
11	38.010	50	7.173	89	1.875	128	0.623
12	36.240	51	6.905	90	1.818	129	0.607
13	34.570	52	6.648	91	1.736	130	0.592
14	32.980	53	6.403	92	1.710	131	0.577
15	31.470	54	6.167	93	1.658	132	0.563
16	30.040	55	5.942	94	1.609	133	0.549
17	28.680	56	5.726	95	1.561	134	0.535
18	27.390	57	5.519	96	1.515	135	0.521
19	26.170	58	5.320	97	1.470	136	0.509



Friedrich Air Conditioning Company
10001 Reunion Place, Suite 500
San Antonio, TX 78216
800.541.6645
www.friedrich.com

PD-SERIES PACKAGED TERMINAL AIR CONDITIONERS LIMITED WARRANTY

SAVE THIS CERTIFICATE. It gives you specific rights. You may also have other rights which may vary from state to state and province to province.

In the event that your unit needs servicing, contact your nearest authorized service center. If you do not know the nearest service center, ask the company that installed your unit or contact us - see address and telephone number above. To obtain service and/or warranty parts replacement, you must notify an authorized FRIEDRICH Air Conditioning Co. service center, distributor, dealer, or contractor of any defect within the applicable warranty period.

When requesting service: please have the model and serial number from your unit readily available.

Unless specified otherwise herein, the following applies:
FRIEDRICH PACKAGED TERMINAL AIR CONDITIONERS AND HEAT PUMPS

LIMITED WARRANTY - FIRST YEAR (Twelve (12) months from the date of installation). Any part found to be defective in the material or workmanship will be repaired or replaced free of charge by our authorized service center during the normal working hours; and

LIMITED WARRANTY - SECOND THROUGH FIFTH YEAR (Sixty (60) months from the date of installation). ON THE SEALED REFRIGERATION SYSTEM. Any part of the sealed refrigeration system that is defective in material or workmanship will be repaired or replaced free of charge (excluding freight charges) by our authorized service center during normal working hours. The sealed refrigeration system consists of the compressor, metering device, evaporator, condenser, reversing valve, check valve, and the interconnecting tubing.

These warranties apply only while the unit remains at the original site and only to units installed inside the continental United States, Alaska, Hawaii, Puerto Rico, Mexico and Canada. The warranty applies only if the unit is installed and operated in accordance with the printed instructions and in compliance with applicable local installation and building codes and good trade practices. For international warranty information, contact the Friedrich Air Conditioning Company - International Division.

Any defective part to be replaced must be made available to **FRIEDRICH** in exchange for the replacement part. Reasonable proof must be presented to establish the date of install, otherwise the beginning date of this certificate will be considered to be our shipment date plus sixty days. Replacement parts can be new or remanufactured. Replacement parts and labor are only warranted for any unused portion of the unit's warranty.

We will not be responsible for and the user will pay for:

1. Service calls to:
A) Instruct on unit operation. B) Replace house fuses or correct house wiring. C) Clean or replace air filters. D) Remove the unit from its installed location when not accessible for service required. E) Correct improper installations.
2. Parts or labor provided by anyone other than an authorized service center.
3. Damage caused by:
A) Accident, abuse, negligence, misuse, riot, fire, flood, or acts of God. B) Operating the unit where there is a corrosive atmosphere containing chlorine, fluorine, or any damaging chemicals (other than in a normal residential environment). C) Unauthorized alteration or repair of the unit, which in turn affects its stability or performance. D) Failing to provide proper maintenance and service. E) Using an incorrect power source. F) Faulty installation or application of the unit.

We shall not be liable for any incidental, consequential, or special damages or expenses in connection with any use or failure of this unit. We have not made and do not make any representation or warranty of fitness for a particular use or purpose and there is no implied condition of fitness for a particular use or purpose. We make no expressed warranties except as stated in this certificate. No one is authorized to change this certificate or to create for us any other obligation or liability in connection with this unit. Any implied warranties shall last for one year after the original purchase date. Some states and provinces do not allow limitations on how long an implied warranty or condition lasts, so the above limitations or exclusions may not apply to you. The provisions of this warranty are in addition to and not a modification of or subtraction from the statutory warranties and other rights and remedies provided by law.

Performance of Friedrich's Warranty obligation is limited to one of the following methods:

1. Repair of the unit
2. A refund to the customer for the prorated value of the unit based upon the remaining warranty period of the unit.
3. Providing a replacement unit of equal value

The method of fulfillment of the warranty obligation is at the sole discretion of Friedrich Air Conditioning.

In case of any questions regarding the provisions of this warranty, the English version will govern.

2011 PTAC EXPLODED VIEW

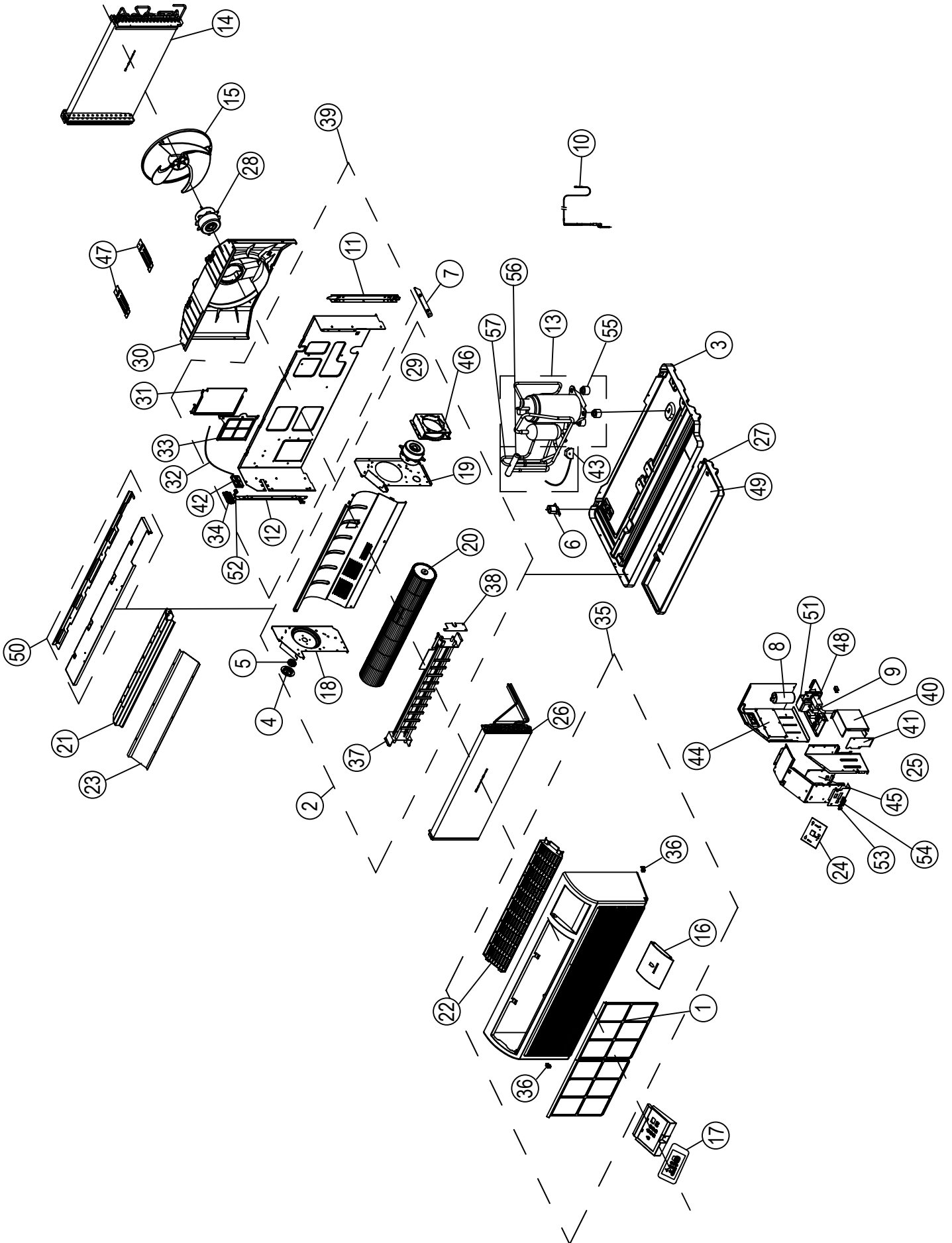

2011 PTAC PARTS LIST - PDE MODELS

Ref. #	Description	Qty	PDE07K3SF	PDE07R3SF	PDE09K3SF	PDE09R3SF	PDE12K3SF	PDE12R3SF	PDE15K5SF	PDE15R5SF
			Part #	Part #	Part #	Part #	Part #	Part #	Part #	Part #
1	Air Filter (Pair)	2	68700138	68700138	68700138	68700138	68700138	68700138	68700138	68700138
	Air Guide	1	68700055	68700056	68700057	68700058	68700082	68700083	68700082	68700083
*	Ambient Temperature Sensor	1	68700152	68700152	68700152	68700152	68700152	68700152	68700152	68700152
3	Basepan	1	68700096	68700096	68700015	68700096	68700097	68700097	68700077	68700077
4	Bearing Cap	1	68700127	68700127	68700127	68700127	68700127	68700127	68700127	68700127
5	Bearing Support, Rubber sub-assy	1	68700147	68700147	68700147	68700147	68700147	68700147	68700147	68700147
6	Bellows Drain Valve	1	68700134	68700134	68700134	68700134	68700134	68700134	68700134	68700134
7	Bottom Inner Wall Brace	1	68700118	68700118	68700118	68700118	68700118	68700118	68700118	68700118
8	Capacitor	1	68700100	68700100	68700107	68700100	68700107	68700107	68700044	68700107
9	Capacitor, Fan	1	68700113	68700113	68700113	68700113	68700109	68700108	68700109	68700109
9	Capacitor, Fan	1	68700091	68700108	68700091	68700108	68700113	68700109	68700113	68700108
10	Capillary Tube Assy	1	68700085	68700085	68700017	68700016	68700084	68700084	68700059	68700059
11	Chassis Flange, Right	1	68700124	68700124	68700124	68700124	68700124	68700124	68700124	68700124
12	Chassis Flange, Left	1	68700125	68700125	68700125	68700125	68700125	68700125	68700125	68700125
13	Compressor Assy	1	68700050	68700049	68700001	68700004	68700047	68700048	68700005	68700006
14	Condenser Coil	1	68700081	68700081	68700102	68700102	68700102	68700102	68700080	68700080
15	Condenser Fan Blade	1	68700135	68700135	68700135	68700135	68700135	68700135	68700135	68700135
16	Control Door	1	68700145	68700145	68700145	68700145	68700145	68700145	68700145	68700145
17	Control Panel Overlay Escutcheon	1	68700158	68700158	68700158	68700158	68700158	68700158	68700158	68700158
18	Cross flow fan support, left	1	68700129	68700129	68700129	68700129	68700129	68700129	68700129	68700129
19	Cross flow fan support, right	1	68700130	68700130	68700130	68700130	68700130	68700130	68700130	68700130
20	Cross Flow Fan, Evaporator	1	68700136	68700136	68700136	68700136	68700136	68700136	68700136	68700136
21	Deck	1	68700131	68700131	68700131	68700131	68700131	68700131	68700131	68700131
22	Discharge Grille	1	68700143	68700143	68700143	68700143	68700143	68700143	68700143	68700143
23	Discharge Screen	1	68700122	68700122	68700122	68700122	68700122	68700122	68700122	68700122
24	Display Board	1	68700151	68700151	68700151	68700151	68700151	68700151	68700151	68700151
25	Electric Box Assy	1	68700028	68700030	68700032	68700034	68700036	68700038	68700040	68700042
26	Evaporator Coil	1	68700079	68700079	68700014	68700013	68700101	68700101	68700101	68700101
27	Evaporator Foam Drain Tray	1	68700141	68700141	68700141	68700141	68700141	68700141	68700141	68700141
28	Fan Motor, Condenser	1	68700087	68700088	68700087	68700088	68700078	68700086	68700078	68700086
29	Fan Motor, Evaporator	1	68700072	68700073	68700070	68700071	68700089	68700090	68700089	68700090
30	Fan Shroud + Motor Mount	1	68700137	68700137	68700137	68700137	68700137	68700137	68700137	68700137
31	Fresh Air Door	1	68700121	68700121	68700121	68700121	68700121	68700121	68700121	68700121
32	Fresh Air Door Cable	1	68700133	68700133	68700133	68700133	68700133	68700133	68700133	68700133
33	Fresh Air Door Filter	1	68700139	68700139	68700139	68700139	68700139	68700139	68700139	68700139
34	Fresh Air Door Lever	1	68700148	68700148	68700148	68700148	68700148	68700148	68700148	68700148
35	Front Panel Assy (Complete)	1	68700144	68700144	68700144	68700144	68700144	68700144	68700144	68700144
36	Front Panel clip	2	68700128	68700128	68700128	68700128	68700128	68700128	68700128	68700128
37	Heater	1	68700074	68700075	68700098	68700099	68700098	68700099	68700098	68700099
38	Heater Wiring Block Board	1	68700126	68700126	68700126	68700126	68700126	68700126	68700126	68700126
39	Inner Wall assy	1	68700115	68700115	68700115	68700115	68700115	68700115	68700115	68700115
40	Junction box	1	68700120	68700120	68700120	68700120	68700120	68700120	68700120	68700120
41	Junction lid	1	68700117	68700117	68700117	68700117	68700117	68700117	68700117	68700117
42	Lower cover of Fresh Air Door Lever	1	68700150	68700150	68700150	68700150	68700150	68700150	68700150	68700150
44	Relay board	1	68700105	68700105	68700105	68700105	68700105	68700105	68700105	68700105
45	Logic board	1	68700103	68700104	68700103	68700104	68700103	68700104	68700103	68700104
46	Motor Bracket, Indoor	1	68700123	68700123	68700123	68700123	68700123	68700123	68700123	68700123
*	Overload Protector	1	68700052	68700051	n/a	68700162	68700053	68700161	68700010	68700009
47	Shroud Brace	2	68700119	68700119	68700119	68700119	68700119	68700119	68700119	68700119
*	Temperature Sensor	1	68700110	68700110	68700110	68700110	68700110	68700110	68700110	68700110
48	Terminal Board, Input power	2	68700156	68700156	68700156	68700156	68700156	68700156	68700156	68700156
49	Thermal baffle	1	68700132	68700132	68700132	68700132	68700132	68700132	68700132	68700132
50	Top Cover Plate Sub-Assy	1	68700116	68700116	68700116	68700116	68700116	68700116	68700116	68700116
51	Transformer	1	68700112	68700111	68700112	68700111	68700112	68700111	68700112	68700111
*	Tube Thermistor	1	68700153	68700153	68700153	68700153	68700153	68700153	68700153	68700153
52	Upper cover of Fresh Air Door Lever	1	68700149	68700149	68700149	68700149	68700149	68700149	68700149	68700149
53	Wiring Terminal, 2 position 24VAC	1	68700154	68700154	68700154	68700154	68700154	68700154	68700154	68700154
54	Wiring Terminal, 7 position 24VAC	1	68700155	68700155	68700155	68700155	68700155	68700155	68700155	68700155
55	Compressor Grommets	3	68700046	68700046	68700046	68700046	68700046	68700046	68700046	68700076

2011 PTAC PARTS LIST - PDH MODELS

			PDH07K3SF	PDH07R3SF	PDH09K3SF	PDH09R3SF	PDH12K3SF	PDH12R3SF	PDH15K5SF	PDH15R5SF
Ref. #	Description	Qty	Friedrich #	Friedrich #	Friedrich #	Friedrich #	Friedrich #	Friedrich #	Friedrich #	Friedrich #
1	Air Filter (Pair)	2	68700138	68700138	68700138	68700138	68700138	68700138	68700138	68700138
2	Air Guide	1	68700055	68700056	68700057	68700058	68700082	68700083	68700082	68700083
*	Ambient Temperature Sensor	1	68700152	68700152	68700152	68700152	68700152	68700152	68700152	68700152
3	Basepan	1	68700096	68700096	68700097	68700097	68700097	68700097	68700160	68700077
4	Bearing Cap	1	68700127	68700127	68700127	68700127	68700127	68700127	68700127	68700127
5	Bearing Support, Rubber sub-assy	1	68700147	68700147	68700147	68700147	68700147	68700147	68700147	68700147
6	Bellows Drain Valve	1	68700134	68700134	68700134	68700134	68700134	68700134	68700134	68700134
7	Bottom Inner Wall Brace	1	68700118	68700118	68700118	68700118	68700118	68700118	68700118	68700118
8	Capacitor	1	68700100	68700100	68700107	68700100	68700107	68700107	68700043	68700107
9	Capacitor, Fan	1	68700113	68700113	68700113	68700113	68700109	68700108	68700109	68700109
9	Capacitor, Fan	1	68700091	68700108	68700091	68700108	68700113	68700109	68700113	68700108
10	Capillary Tube Assy	1	68700085	68700085	68700060	68700060	68700084	68700084	68700018	68700019
11	Chassis Flange, Left	1	68700124	68700124	68700124	68700124	68700124	68700124	68700124	68700124
12	Chassis Flange, Right	1	68700125	68700125	68700125	68700125	68700125	68700125	68700125	68700125
13	Compressor Assy	1	68700050	68700049	68700002	68700003	68700047	68700048	68700007	68700008
14	Condenser Coil	1	68700081	68700081	68700102	68700102	68700102	68700102	68700080	68700080
15	Condenser Fan Blade	1	68700135	68700135	68700135	68700135	68700135	68700135	68700135	68700135
16	Control Door	1	68700145	68700145	68700145	68700145	68700145	68700145	68700145	68700145
17	Control Panel Overlay Escutcheon	1	68700158	68700158	68700158	68700158	68700158	68700158	68700158	68700158
18	Cross flow fan support, left	1	68700129	68700129	68700129	68700129	68700129	68700129	68700129	68700129
19	Cross flow fan support, right	1	68700130	68700130	68700130	68700130	68700130	68700130	68700130	68700130
20	Cross Flow Fan, Evaporator	1	68700136	68700136	68700136	68700136	68700136	68700136	68700136	68700136
21	Deck	1	68700131	68700131	68700131	68700131	68700131	68700131	68700131	68700131
22	Discharge Grille	1	68700143	68700143	68700143	68700143	68700143	68700143	68700143	68700143
23	Discharge Screen	1	68700122	68700122	68700122	68700122	68700122	68700122	68700122	68700122
24	Display Board	1	68700151	68700151	68700151	68700151	68700151	68700151	68700151	68700151
25	Electric Box Assy	1	68700029	68700031	68700033	68700035	68700037	68700039	68700041	68700027
26	Evaporator Coil	1	68700079	68700079	68700054	68700054	68700101	68700101	68700101	68700101
27	Evaporator Foam Drain Tray	1	68700141	68700141	68700141	68700141	68700141	68700141	68700141	68700141
28	Fan Motor, Condenser	1	68700087	68700088	68700087	68700088	68700078	68700086	68700089	68700086
29	Fan Motor, Evaporator	1	68700072	68700073	68700070	68700071	68700089	68700090	68700026	68700090
30	Fan Shroud + Motor Mount	1	68700137	68700137	68700137	68700137	68700137	68700137	68700137	68700137
31	Fresh Air Door	1	68700121	68700121	68700121	68700121	68700121	68700121	68700121	68700121
32	Fresh Air Door Cable	1	68700133	68700133	68700133	68700133	68700133	68700133	68700133	68700133
33	Fresh Air Door Filter	1	68700139	68700139	68700139	68700139	68700139	68700139	68700139	68700139
34	Fresh Air Door Lever	1	68700148	68700148	68700148	68700148	68700148	68700148	68700148	68700148
35	Front Panel Assy (Complete)	1	68700144	68700144	68700144	68700144	68700144	68700144	68700144	68700144
36	Front Panel clip	2	68700128	68700128	68700128	68700128	68700128	68700128	68700128	68700128
37	Heater	1	68700074	68700075	68700098	68700099	68700098	68700099	68700098	68700099
38	Heater Wiring Block Board	1	68700126	68700126	68700126	68700126	68700126	68700126	68700126	68700126
39	Inner Wall assy	1	68700115	68700115	68700115	68700115	68700115	68700115	68700115	68700115
40	Junction box	1	68700120	68700120	68700120	68700120	68700120	68700120	68700120	68700120
41	Junction lid	1	68700117	68700117	68700117	68700117	68700117	68700117	68700117	68700117
42	Lower cover of Fresh Air Door Lever	1	68700150	68700150	68700150	68700150	68700150	68700150	68700150	68700150
43	Solenoid Coil	1	68700093	68700092	68700093	68700092	68700093	68700092	68700093	68700092
44	Relay board	1	68700106	68700106	68700106	68700106	68700106	68700106	68700106	68700106
45	Logic board	1	68700103	68700104	68700103	68700104	68700103	68700104	68700103	68700104
46	Motor Bracket, Indoor	1	68700123	68700123	68700123	68700123	68700123	68700123	68700123	68700123
*	Overload Protector	1	68700052	68700051	68700012	n/a	68700053	n/a	n/a	68700011
47	Shroud Brace	2	68700119	68700119	68700119	68700119	68700119	68700119	68700119	68700119
48	Terminal Board, Input power	2	68700156	68700156	68700156	68700156	68700156	68700156	68700156	68700156
49	Thermal baffle	1	68700132	68700132	68700132	68700132	68700132	68700132	68700132	68700132
50	Top Cover Plate Sub-Assy	1	68700116	68700116	68700116	68700116	68700116	68700116	68700116	68700116
51	Transformer	1	68700112	68700111	68700112	68700111	68700112	68700111	68700112	68700111
*	Tube Thermistor	2	68700153	68700153	68700153	68700153	68700153	68700153	68700153	68700153
52	Upper cover of Fresh Air Door Lever	1	68700149	68700149	68700149	68700149	68700149	68700149	68700149	68700149
53	Wiring Terminal, 2 position 24VAC	1	68700154	68700154	68700154	68700154	68700154	68700154	68700154	68700154
54	Wiring Terminal, 7 position 24VAC	1	68700155	68700155	68700155	68700155	68700155	68700155	68700155	68700155
55	Compressor Gasket	3	n/a	n/a	n/a	n/a	n/a	n/a	68700045	68700076
56	4-way Reversing Valve Assy	1	68700094	68700094	68700094	68700094	68700095	68700095	68700095	68700095
56	4-way Reversing Valve Assy	1	68700062	68700062	68700063	68700063	68700061	68700061	68700020	68700021



F R I E D R I C H

FRIEDRICH AIR CONDITIONING CO.

10001 Reunion Place, Ste. 500, San Antonio, TX 78216

P 210-546-0500 | F 210-546-0731

www.friedrich.com

Printed in the U.S.A.

PD-ServMan-E (2-11)